

P802.1CM TIME-SENSITIVE NETWORKING FOR FRONTHAUL

Introduction

János Farkas
janos.farkas@ericsson.com

November 10, 2015

WELCOME!

NOTE

- › This presentation should be considered as the personal views of the presenter not as a formal position, explanation, or interpretation of IEEE 802.1.

AGENDA

- › IEEE 802.1 Overview

- › IEEE 802.1 Time-Sensitive Networking (TSN)
 - Audio Video Bridging (AVB) and TSN
 - Ongoing TSN projects
 - Some TSN tools

- › P802.1CM TSN for Fronthaul
 - Status update
 - Draft 0.0 overview
 - <http://www.ieee802.org/1/files/private/cm-drafts/d0/802-1CM-d0-0.pdf>

- › Bridge architecture

IEEE 802.1 OVERVIEW

IEEE 802 LAN/MAN STANDARDS COMMITTEE (AKA IEEE 802 OR LMSC)

- › Develop LAN and MAN standards
- › Mainly for link and physical layers of the network stack
- › In operation since March 1980

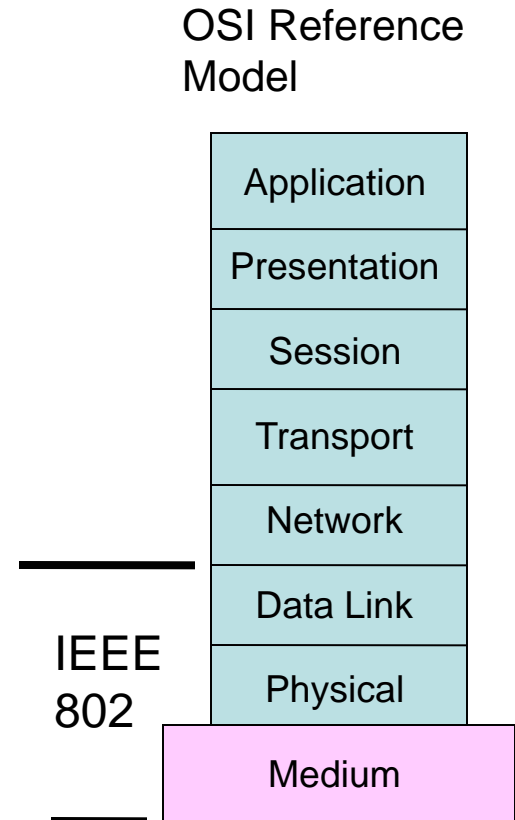

IEEE STANDARDS ORGANIZATION

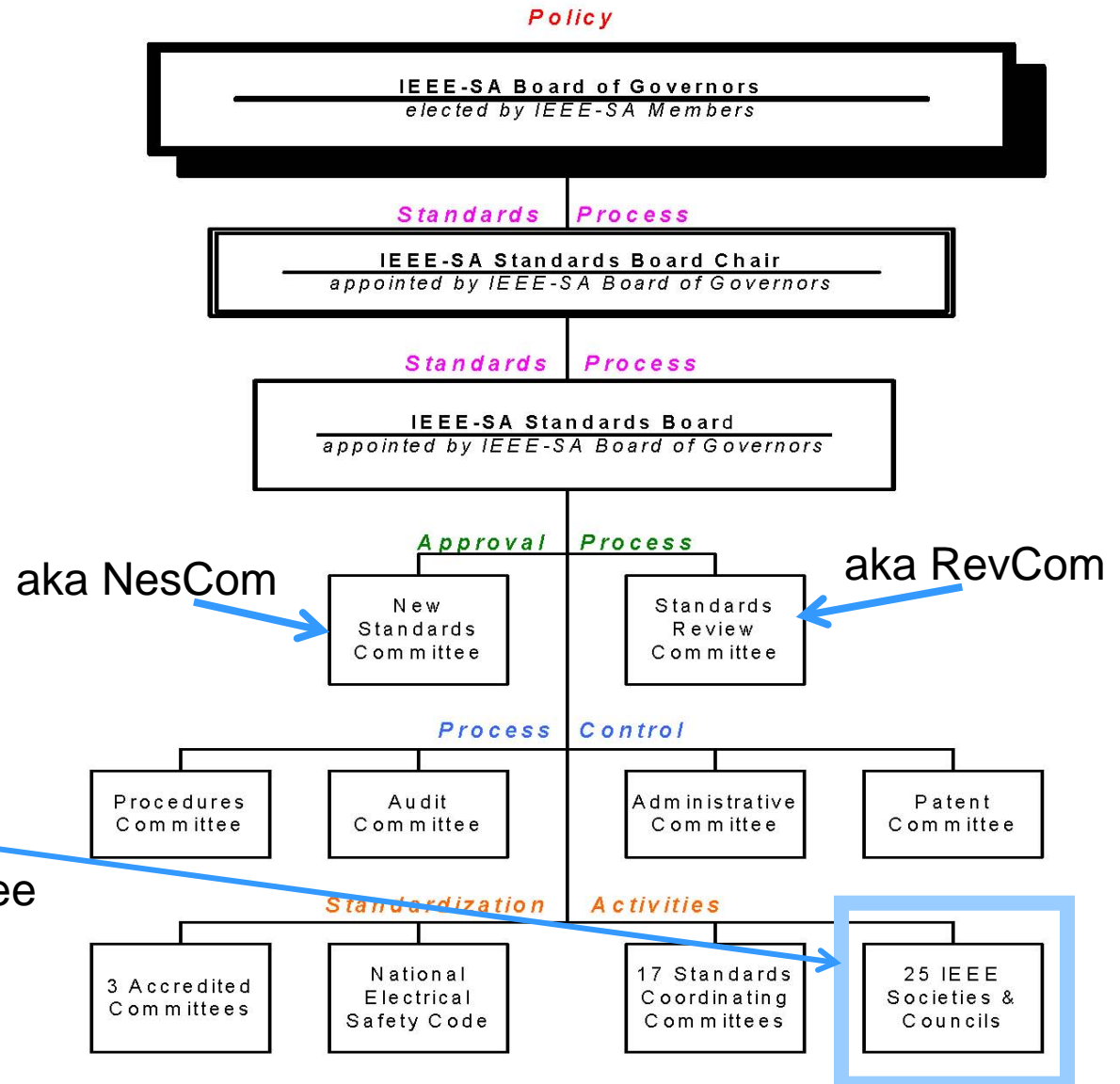

IEEE 802 is here:
a standards committee
formed by the
Computer Society

SOME TERMS

- › PAR – Project Authorization Request – the document that authorizes work on a project.
- › CSD – Criteria for Standards Development – the basis for determining whether to forward a PAR.
- › WG - Working Group – responsible for developing standards in an area
- › TAG – Technical Advisory Group – experts on a topic area that crosses working groups – may develop a recommended practice.
- › Task Group (TG) or task force – a part of a Working Group which focuses on a particular project.

ALL THOSE DOTS

- › 802.1 Bridging and Architecture
 - generally the top of the link layer
- › 802.3 Ethernet
- › 802.11 Wireless LAN (WLAN)
- › 802.15 Wireless Personal Area Network (WPAN)
- › 802.16 Broadband Wireless Access (BWA)
- › 802.18 Radio Regulatory TAG
- › 802.19 Coexistence
- › 802.21 Media Independent Handover
- › 802.22 Wireless Regional Area Networks (WRAN)
- › 802.24 Smart Grid TAG

PRINCIPLES OF THE IEEE STANDARDS PROCESS

- › **Due process** – procedures are publicly available and followed consistently
- › **Consensus** – requiring agreement of a majority or supermajority – for technical decisions here $\geq 75\%$
- › **Openness** – ensuring materially interested and affected parties can participate
- › **Balance** – representation from all interested parties without overwhelming influence from any one party
- › **Right of appeal** – process to ensure due process

IEEE 802.1 WORKING GROUP

- › Chair: Glenn Parsons
- › Vice-chair: John Messenger
- › Time-Sensitive Networking (TSN) TG
 - Chair: Michael David Johas Teener
 - Vice-chair: János Farkas
- › Security TG
 - Chair: Michael Seaman
- › Data Center Bridging (DCB) TG
 - Chair: Patricia Thaler
- › OmniRAN TG
 - Chair: Maximilian Rigel
- › Maintenance TG
 - Chair: John Messenger

IEEE 802.1 STANDARDS

- › The ones with capital letters, e.g. 802.1Q or 802.1AX are independent standards
- › Amendments to these standards are identified by lower case letters e.g. 802.1ah, 802.1Qbg or 802.1AEbn
- › Periodically the amendments get merged into a revision of the main standard, e.g. 802.1ah and 802.1Qay are part of 802.1Q-2014
- › 802.1Q can be considered as many individual standards integrated into a single document
 - Clauses 6 through 9 give a general overview of the 802.1Q bridge architecture
 - To get oriented on an additional area, it's best to read the Clause titled the "Principles of <area>"
 - Once oriented, references in the subclause of Clause 5 Conformance for the relevant device can be helpful

NAVIGATION

- › <http://www.ieee802.org/1> (projects, drafts, everything)
- › <http://www.ieee802.org/1/pages/tsn.html>
- › public folder: <http://www.ieee802.org/1/files/public>
- › file upload: at the bottom of <http://www.ieee802.org/1/filenaming.html>
 - Follow the file naming conventions please
- › TSN agenda: <http://www.802tsn.org/agenda>
 - request: <http://www.802tsn.org/agenda-for-next-meeting>
 - request on a virtual meeting: <http://www.802tsn.org/weekly-call-agenda-requests>
- › email list: <http://www.ieee802.org/1/email-pages>
- › f2f meetings: <http://www.ieee802.org/1/meetings>
- › attendance: <https://imat.ieee.org>
- › get program: <https://standards.ieee.org/about/get/802/802.1.html>
- › patent slides:
<http://standards.ieee.org/about/sasb/patcom/materials.html>

IEEE 802.1 TIME-SENSITIVE NETWORKING (TSN)

FROM AVB TO TSN

- › IEEE 802.1 Audio Video Bridging (AVB) Task Group (TG)
 - Started in 2005
 - Address professional audio, video market
 - Consumer electronics
 - Automotive infotainment
 - AVnu Alliance: associated group for compliance and marketing
- › IEEE 802.1 Time-Sensitive Networking (TSN) TG
 - AVB features become interesting for other use cases, e.g.
 - › Industrial
 - › Automotive
 - AVB was not an appropriate name to cover all use cases
 - AVB TG was renamed to TSN TG in 2012
 - Interworking TG and TSN TG were merged in 2015

AVB STANDARDS

- › IEEE Std. 802.1AS – generalized Precision Time Protocol (gPTP)
 - A Layer 2 profile of the IEEE 1588 Precision Time Protocol (PTP)
- › IEEE Std. 802.1Qav – Forwarding and Queuing of Time-Sensitive Streams (FQTSS):
 - Specifies Credit-Based Shaper (CBS)
- › IEEE Std. 802.1Qat – Stream Reservation Protocol (SRP)
 - Registration and reservation of time-sensitive streams
- › IEEE Std. 802.1BA – AVB Systems
 - Provides an overall AVB architecture and AVB profiles
- › CBS + SRP to provide delays under 250 us per bridge

IEEE 802.1 TSN PROJECTS

- › P802.1Qbu – Frame Preemption – ready
 - › P802.1Qbv – Enhancements for Scheduled Traffic – ready
 - › P802.1Qcc – Stream Reservation Protocol (SRP) Enhancements and Performance Improvements
 - › P802.1Qci – Per-Stream Filtering and Policing
 - › P802.1Qch – Cyclic Queuing and Forwarding
 - › 802.1Qcj – Auto-attach to PBB services
 - › P802.1AS-Rev – Timing and Synchronization – Revision
 - › P802.1CB – Frame Replication and Elimination for Reliability
 - › P802.1CM – Time-Sensitive Networking for Fronthaul
- related
- related

FRAME PREEMPTION (ILLUSTRATION)

- Express frames can suspend the transmission preemptable frames

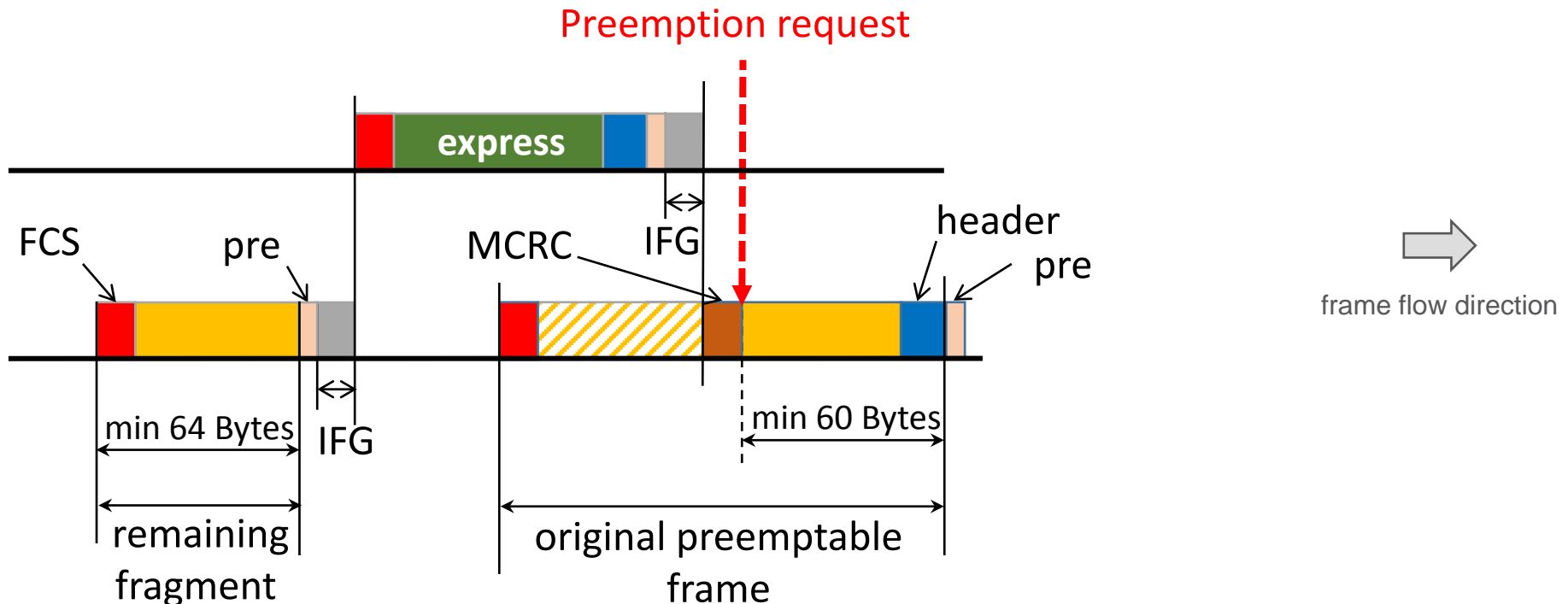

of preemptable frame

FRAME PREEMPTION

- › Time-critical frames can suspend the transmission of non-time-critical frames while one or more time-critical frames are transmitted
- › Specified by
 - 802.3br – Interspersing Express Traffic (IET)
 - 802.1Qbu – Frame Preemption
- › 802.1Qbu makes the adjustments needed in 802.1Q in order to support 802.3br, e.g.
 - each traffic class queue supported by the Port is assigned a value of frame preemption status
 - the possible values of frame preemption status are *express* or *preemptable*
- › Minimum fragment size is 64 bytes including CRC

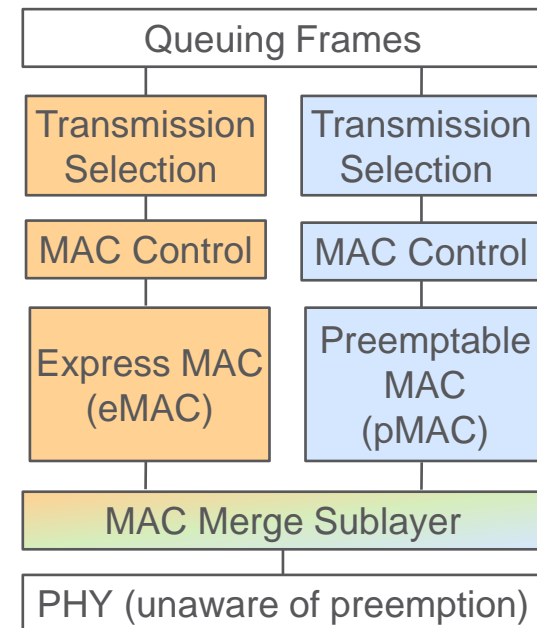

802.1Qbv – ENHANCEMENTS FOR SCHEDULED TRAFFIC

- › Transmission from each queue to be scheduled relative to a known timescale
- › A transmission gate is associated with each queue
 - the state of the gate determines whether or not queued frames can be selected for transmission
 - Open: queued frames are selected for transmission, (according to the transmission selection algorithm associated with the queue)
 - Closed: queued frames are not selected for transmission

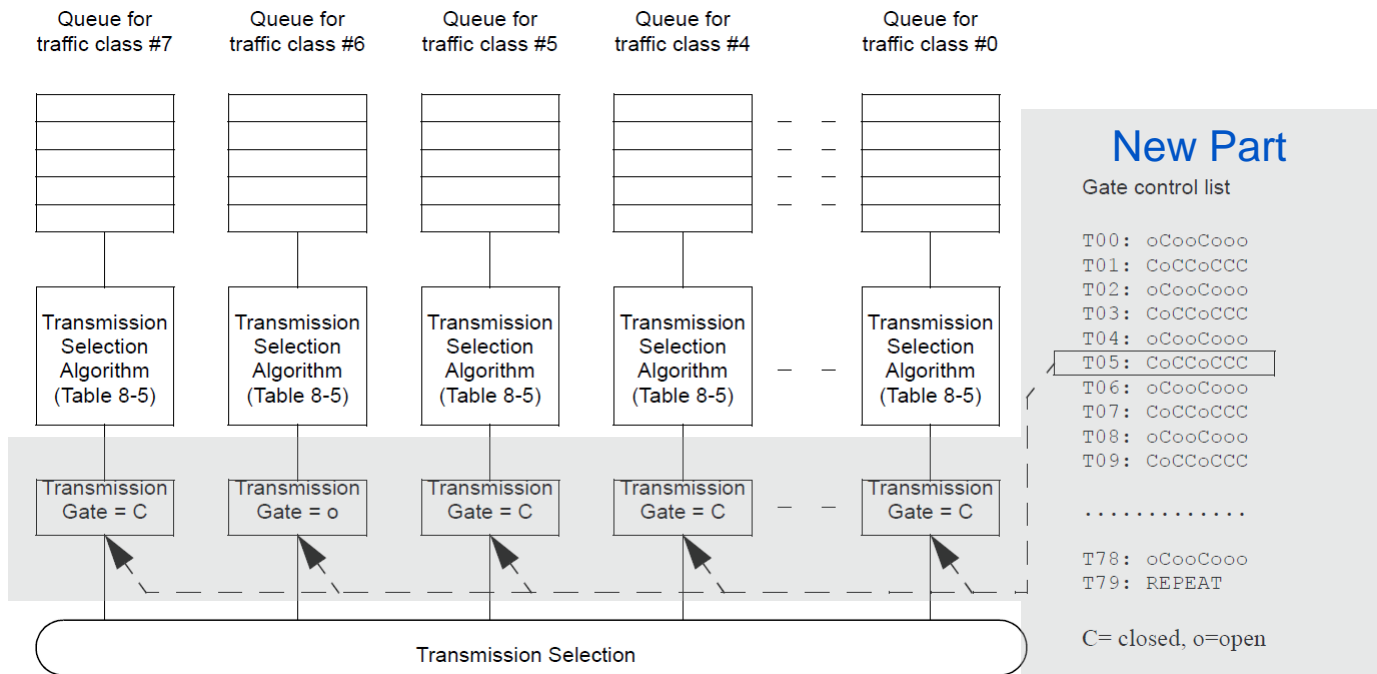

PREEMPTION AND ENHANCED SCHEDULING – OVERVIEW

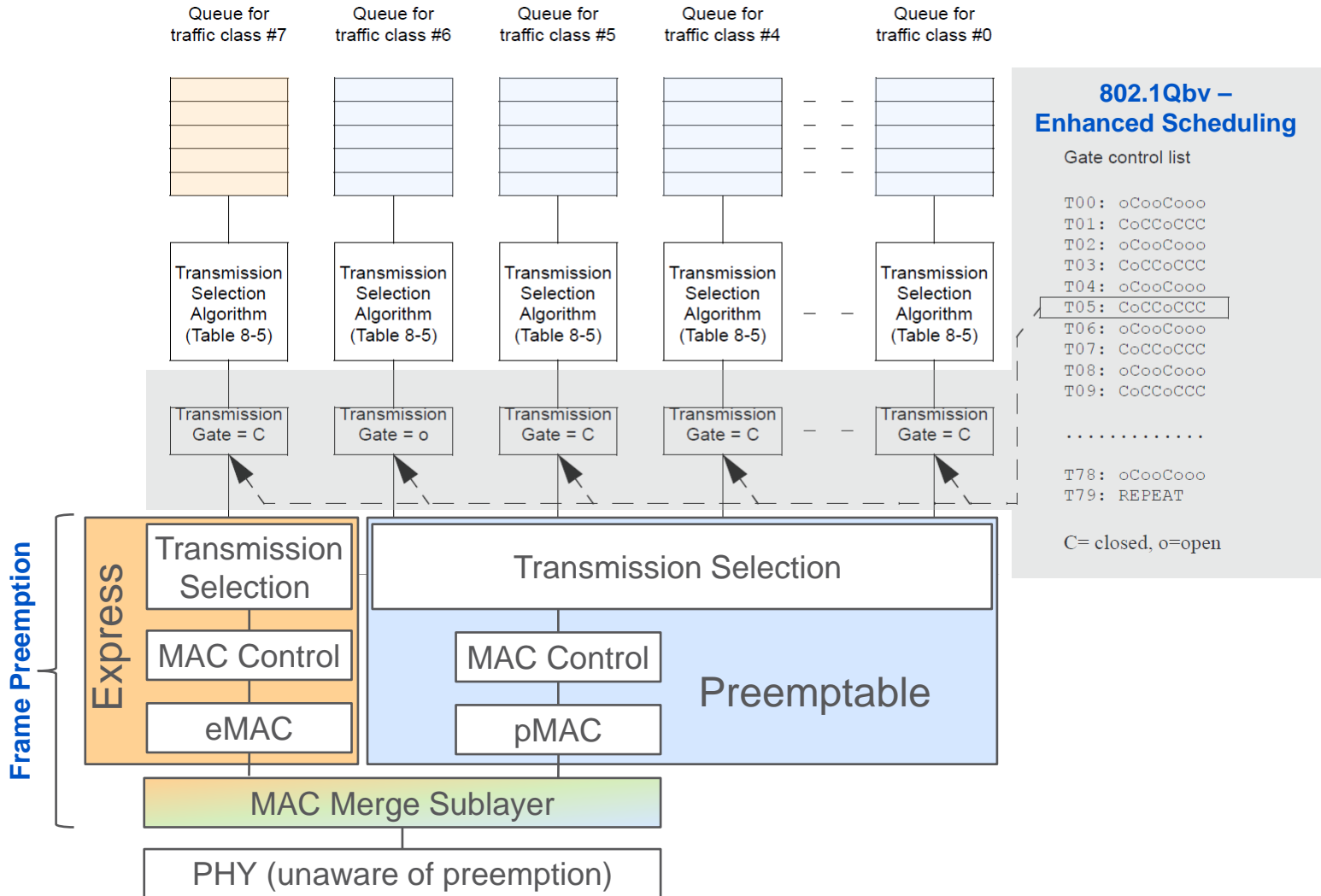

FRAME PREEMPTION AND ENHANCEMENTS FOR SCHEDULED TRAFFIC WITH GUARD BAND

Example 1

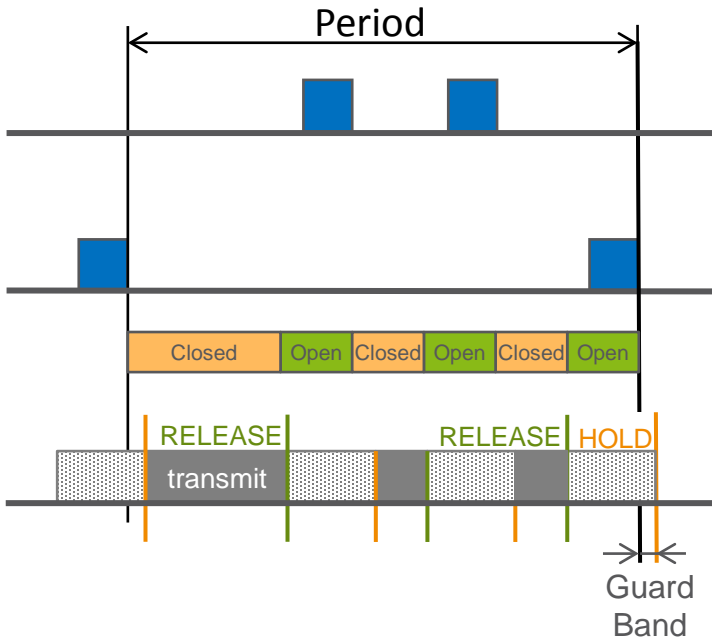

Legend

Express From Port 1

Express From Port 2

Express Gate at egress port

background at egress port



frame flow direction

Example 2

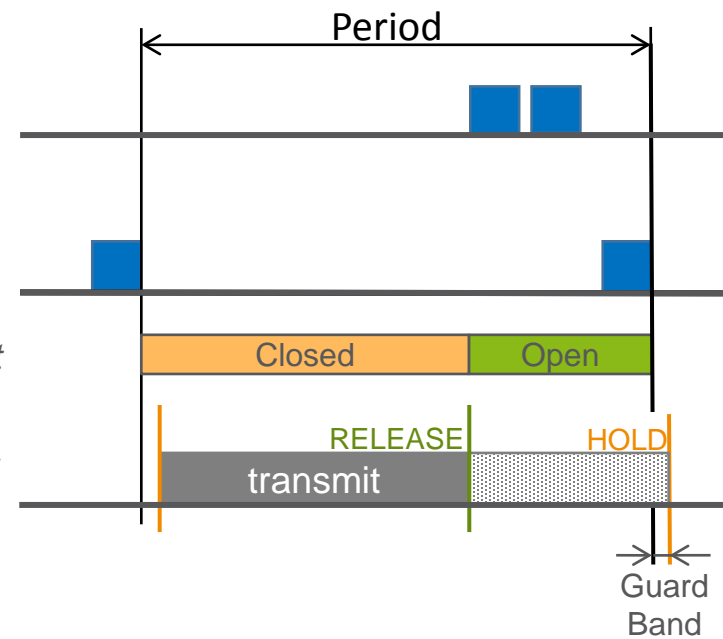

- › Guard band can protect the express traffic completely from interference from preemptable traffic

802.1Qci – PER STREAM FILTERING AND POLICING

- › Perform frame counting, filtering, policing, and service class selection for a frame based on the particular data stream to which the frame belongs
- › A Stream Filter
 - Contains a Stream ID and Priority
 - Selects Stream Gate and Meter for a particular stream
- › A Stream Gate is either Open or Closed

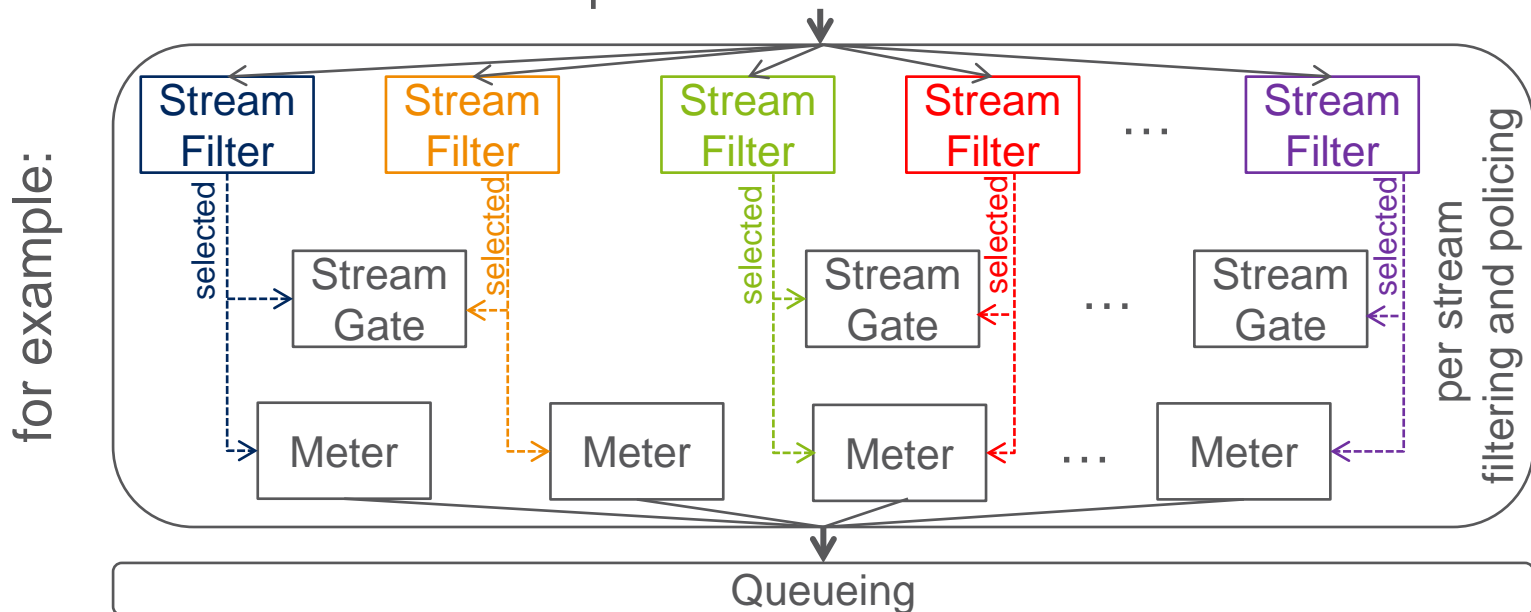

802.1Qch – CYCLIC QUEUEING AND FORWARDING (CQF)

- › Synchronized cyclic enqueueing and queue draining achieve zero congestion loss and deterministic latency
- › Two buffers served alternated, e.g. that of S1 and S2
- › To be combined with frame preemption

Example bridge with two delay classes, S1 and S2

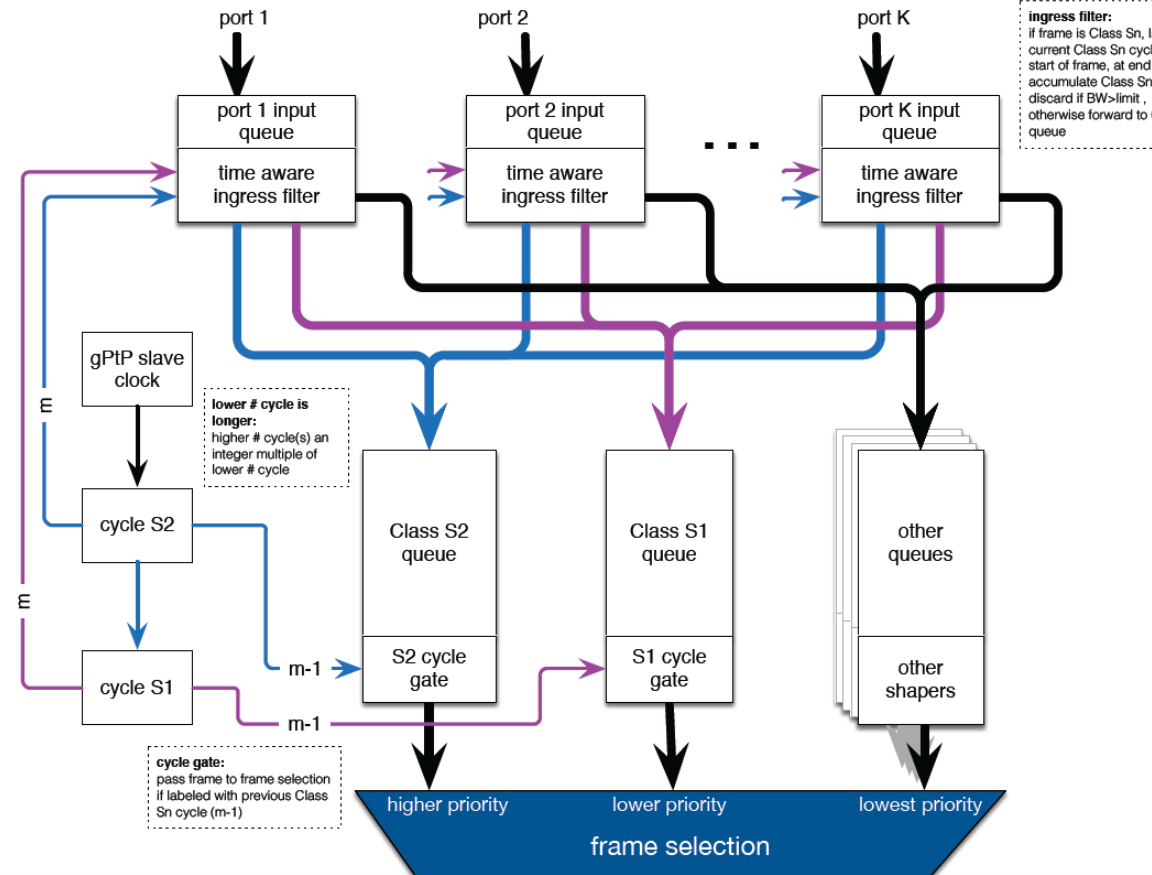

<http://www.ieee802.org/1/files/public/docs2014/new-tsn-mjt-peristaltic-shaper-0114.pdf>

PROFILE

- › IEEE Std. 802.1BA specifies AVB profiles
- › An AVB profile is a set of feature and option selections that specifies aspects of bridge and end station operation, and states the conformance requirements for support of AVB functionality for a specific class of user applications.
- › One of the objectives of an AVB profile is to allow the construction of AVB networks that meet a common performance metric in terms of the worst-case end-to-end latency that a stream will experience in transmission between a Talker and a Listener.
- › A profile identifies functionality defined in other standards
- › TSN profile for fronthaul in the forthcoming slides

P802.1AS-REV – TIMING AND SYNCHRONIZATION

- › A profile of 1588 for Layer 2 Ethernet
- › The Revision includes:
 - › Support for Link Aggregation (802.1AX)
 - › Improved scalability
 - One step processing
 - Improved support for long chains, rings
 - › More responsive
 - Faster Grand Master change over
 - Reduce BMCA convergence time
- › Multiple domains with synchronization information
- › Redundancy
 - configure redundant paths and redundant GMs
- › Further redundancy may be defined by a new project

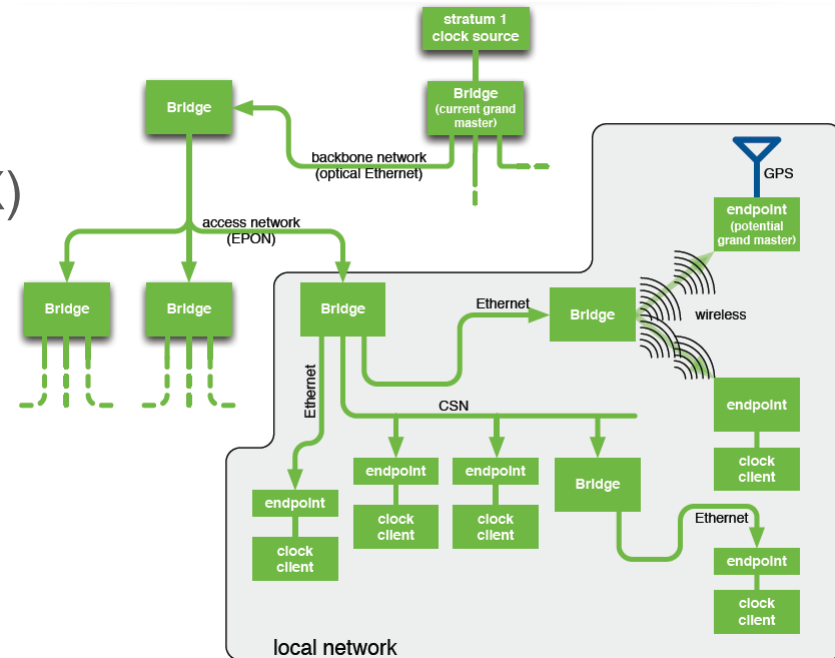

FURTHER READING

- › <http://www.ieee802.org/1>
- › <http://www.802tsn.org>
- › “A Time-Sensitive Networking Primer: Putting It All Together”
https://drive.google.com/file/d/0B6Xurc4m_PVsZ1lzWWoxS0pTNVE/view?usp=sharing
- › “Heterogeneous Networks for Audio and Video: Using IEEE 802.1 Audio Video Bridging” <http://ieeexplore.ieee.org/xpl/articleDetails.jsp?arnumber=6595589>
- › Tutorial on IEEE 802.3br Interspersing express traffic (IET) and IEEE 802.1 Time-Sensitive Networking http://www.ieee802.org/802_tutorials/2015-03/8023-IET-TF-1501-Winkel-Tutorial-20150115_r06.pptx
- › Tutorial on Deterministic Ethernet http://www.ieee802.org/802_tutorials/2012-11/8021-tutorial-final-v4.pdf
- › Tutorial on IEEE 802.1Q http://www.ieee802.org/802_tutorials/2013-03/8021-IETF-tutorial-final.pdf
- › SDN by 802.1Q: <http://www.ieee802.org/1/files/public/docs2014/Q-farkas-SDN-support-0314-v01.pdf>
- › https://en.wikipedia.org/wiki/Audio_Video_Bridging

P802.1CM
TSN FOR FRONTHAUL

GOALS

- › Develop standard TSN profiles for Fronthaul in order to enable the transport of Fronthaul streams in a bridged network
- › The 802.1CM specification
 - will collect requirements for Fronthaul networks
 - will provide guidance for meeting Fronthaul requirements, which includes
 - › selecting 802.1 TSN features in order to build networks capable of transmitting Fronthaul streams like CPRI
 - › describing how the selected TSN features and components can be combined, configured and used in order to meet Fronthaul requirements
- › The P802.1CM project may identify additional TSN functions that would be useful

ROUGH TIMELINE

- › Project Authorization Request (PAR) approved by IEEE 802 (July 17, 2015)
- › PAR approved by IEEE SA NesCom (New Standards Committee) (September 3, 2015)
- › P802.1CM project started: D0.0 (September 8, 2015)
<http://www.ieee802.org/1/files/private/cm-drafts/d0/802-1CM-d0-0.pdf>
 - 1st step: gathering requirements, use cases
- › Task Group Ballots
- › Initial Working Group Ballot
- › Working Group Recirculation Ballot(s)
- › Initial Sponsor Ballot (latest by PAR: July 2018)
- › Sponsor Recirculation Ballot(s)
- › Submission for IEEE SA RevCom (Review Committee) approval (May 2019)

BRIDGE
ARCHITECTURE

CONTROL PLANE SEPARATED FROM DATA PLANE

Simplified “baggy pants” model

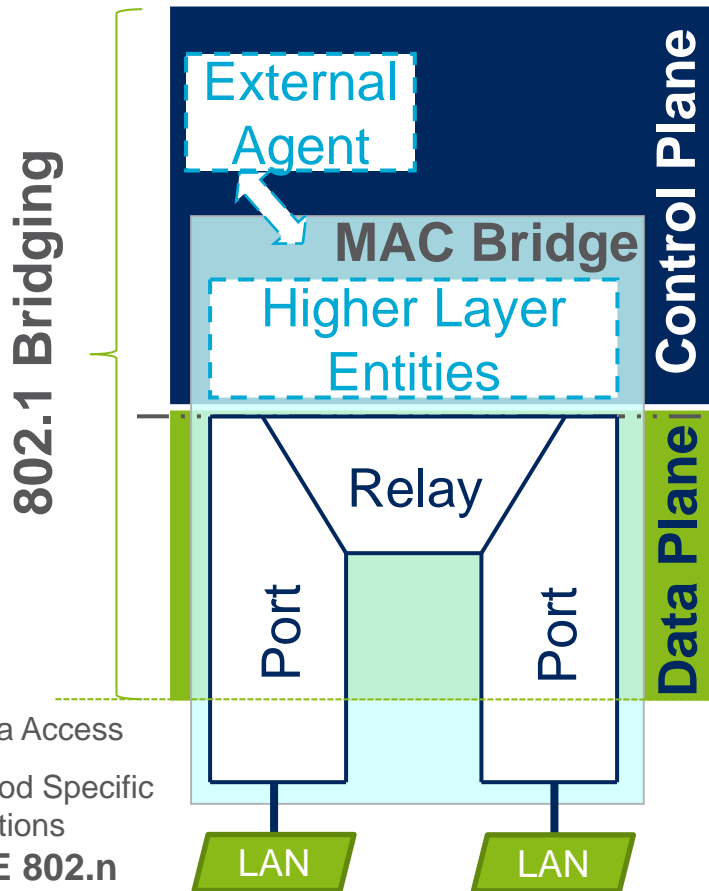

- › Control protocols are implemented as Higher Layer Entities
- › External Agent may provide control instead of the distributed protocols

- › The data plane is comprised of
 - A MAC Relay and
 - At least two ports

see Figure 8-2 – “VLAN-aware Bridge architecture” of 802.1Q for more details

DATA PLANE ACTIONS (IEEE 802.1Q-2014)

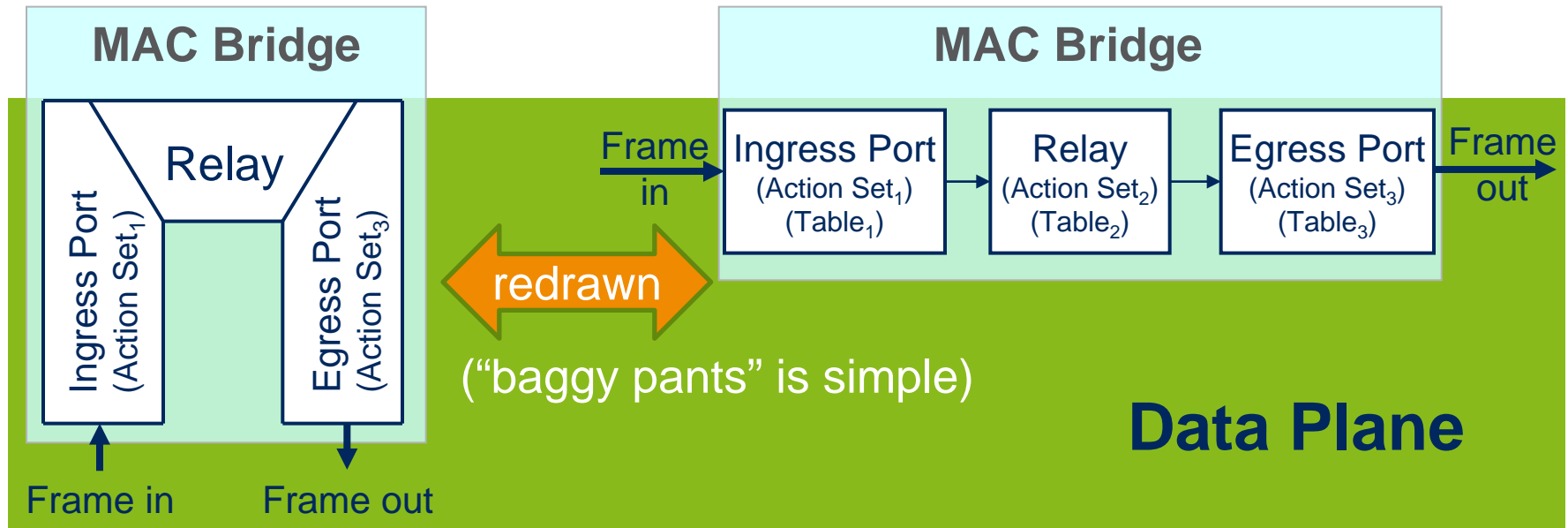

- › Ingress Port (Action Set1)
 - Filtering (drop), (un)tagging, VID translation, de/en-capsulation
- › Relay (Action Set2)
 - Forwarding, filtering
- › Egress Port (Action Set3)
 - Filtering, (un)tagging, VID translation, de/en-capsulation, metering, queuing, transmission selection

CONTROL PLANE OVERVIEW

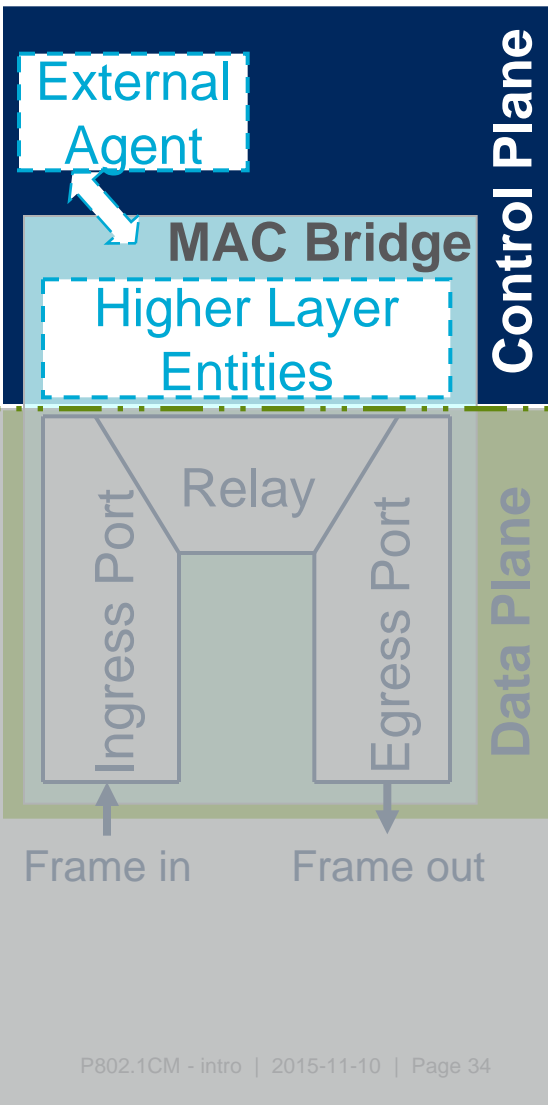

- › A VLAN is assigned to a control mode
 - Multiple control modes may co-exist in the same network
 - Hybrid control by distributed protocols and an External Agent, e.g. and SDN controller for TE paths
 - External control can be a non-802.1 protocol: PCE, GMPLS

VLAN space:	spanning tree VLANs	shortest path VLANs	software defined VLANs
Control:	Multiple Spanning Tree Protocol	Shortest Path Bridging	External Agent

› Summary of control options

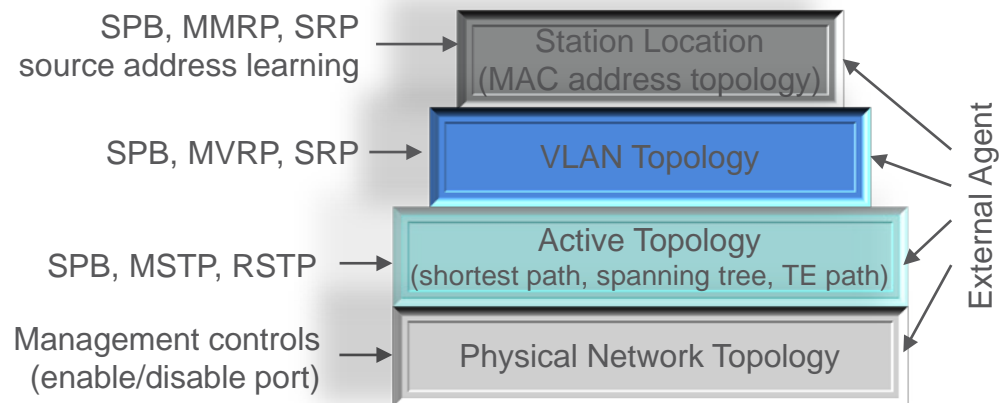

SEE YOU!