

IEC/IEEE 60802

End station model

Requirements and assigned features

Günter Steindl (Siemens AG)

Industrial Automation Verticals

End stations used in industrial communication are often used in more than one vertical.

Thus, the end station model need to cover requirements from these verticals.

Factory automation, Process automation, Motion control, Transportation systems, Building automation and Power generation are just an example for these verticals.

They may rely on different middleware or different network policies but share a similar end station model.

Principle

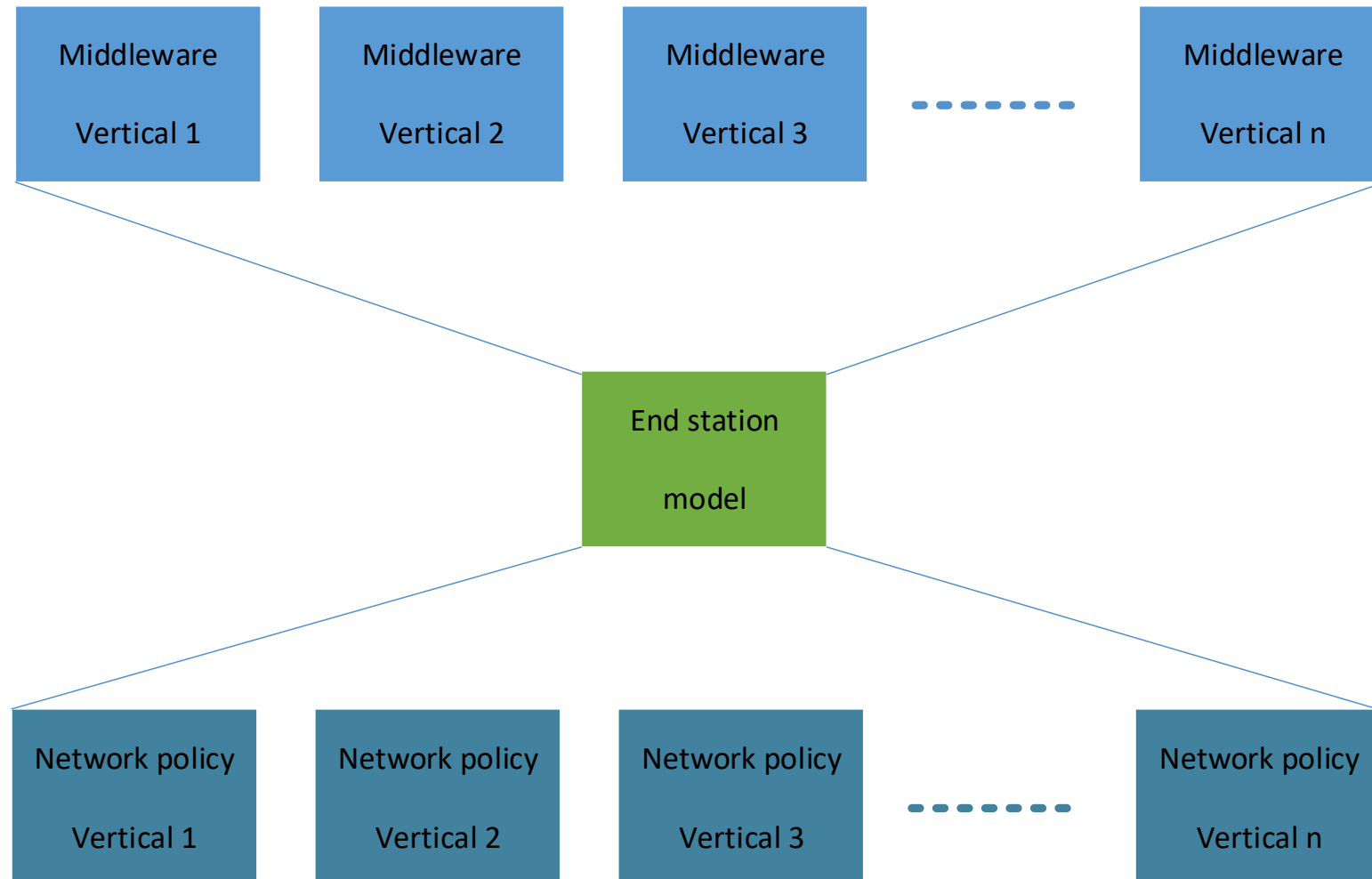

General Requirements

End stations implementing industrial communication protocols are often able to consume the whole bandwidth available at the Ethernet interface.

Thus, disciplining the network access to limit the bandwidth usage is required to avoid immediate frame dropping at the first bridge.

Additionally, knowing about the disciplined interfaces supports the network calculus of a Digital Twin.

End station model

Requirement:

- Data rates from 10 Mbit/s to 10 Gbit/s
- Single Pair Ethernet for Sensors/Actors
- Latency optimized transmit and receive

Solved by:

- IEEE 802.3 MAU types
- Preemption

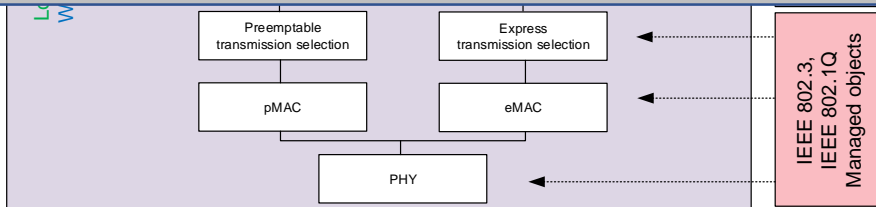

End station model

Requirement:

- Disciplined network access for all traffic classes
- Latency optimized transmit and receive

Solved by:

- Enhancements for scheduled traffic for end-stations
- Enhanced transmission selection (DCBX support optional)
- Working Clock

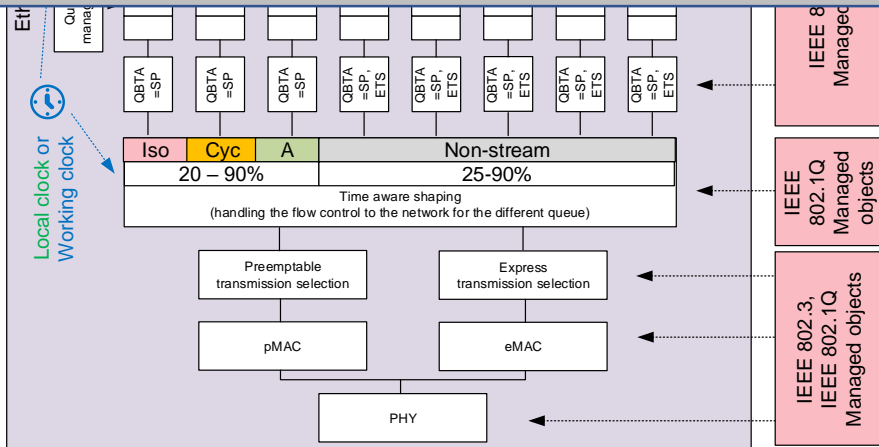

End station model

Requirement:

- Up to 8 traffic classes
- Up to 3 cyclic transmitted stream classes

Solved by:

- Traffic class model

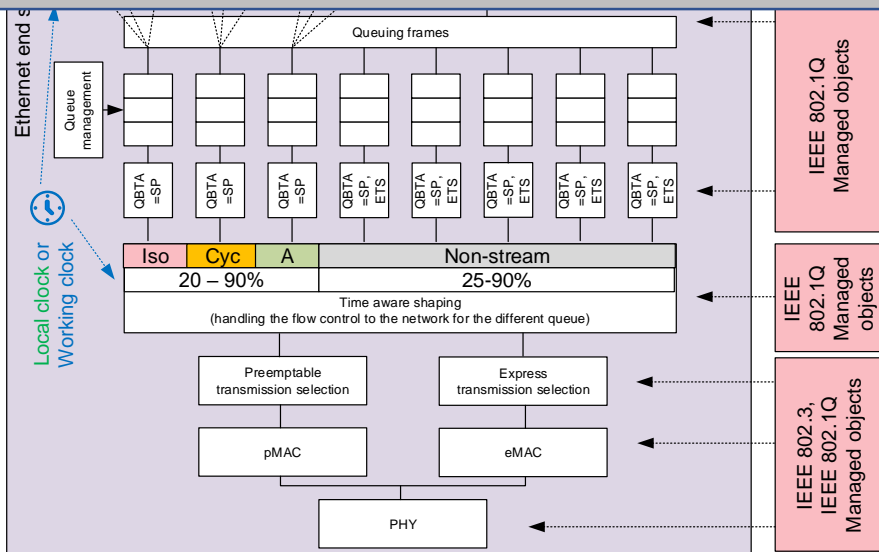

End station model

Requirement:

- Support for at least 512 talkers / streams
- Transmit interval 25µs/31,25µs to 1s for cyclic transmitted streams
- Time triggered transmit (frame based)

Solved by:

- Additional queues used as input queues for the traffic classes (additional definitions may be needed)
- Working Clock

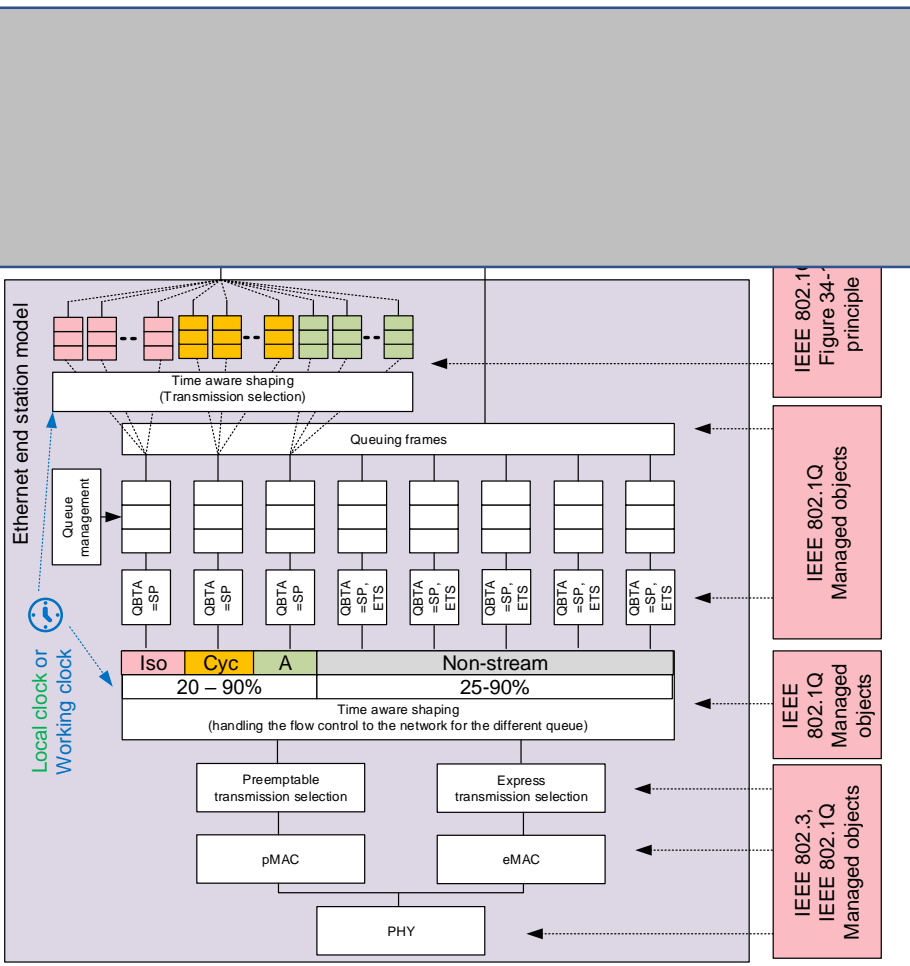

End station model

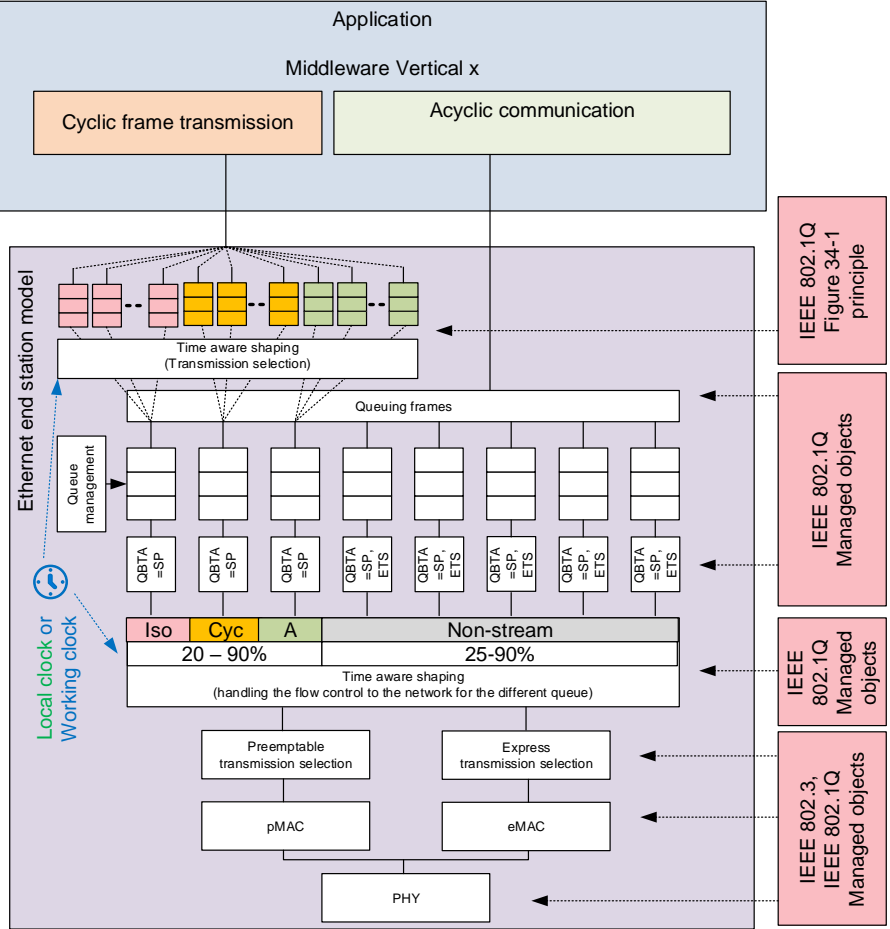

Requirement:

- Middleware requirements from the different industrial automation verticals

Solved by:

- Common end station model

Conclusion

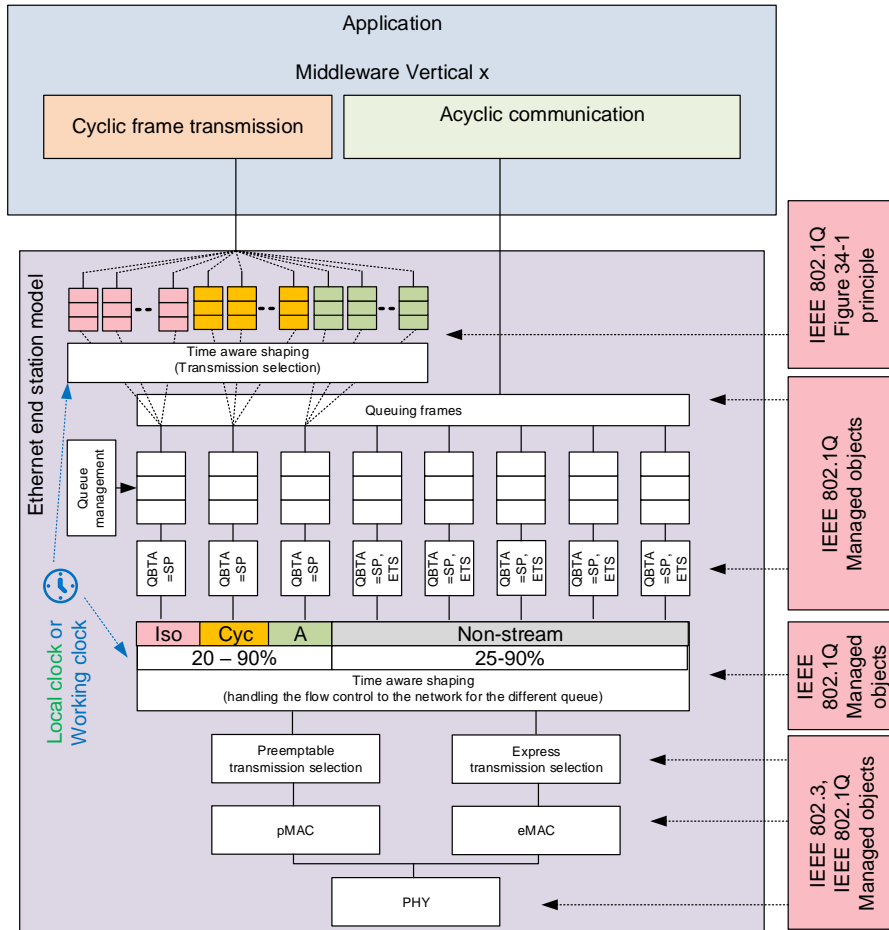

An end station model covering the requirements known by the author of this contribution based on the IEEE802 building blocks can be referenced by the 60802.

The number of traffic classes for cyclic and acyclic communication is derived from the above statement.

Proposal

- Specify an end station model covering requirements from many industrial automation verticals
- Functionalities of this model may be stated optional, but shall be specified in detail in the 60802
- Configuration of shown managed objects of the end station is done by network management of the TSN domain
- Principles shown in Figure 34-1 of 802.1Q may need additional text to cover the automation requirements

Questions ?