

Project: IEEE P802.15 Study Group for Wireless Personal Area Networks (WPANs)

Submission Title: PSSS proposal – Parallel reuse of 2.4 GHz PHY for the sub-1-GHz bands

Date Submitted: 11 November 2004

Source: Andreas Wolf, Dr. Wolf & Associates and Hans van Leeuwen, STS-wireless

DWA Wireless GmbH

Tel.: +49 (0)700 965 32 637

aw@dw-a.com

STS BV, The Netherlands

Tel: +31 20 4204200, cell +1 858 344 5120

hvl@sts.nl

Re: Proposal and Discussion of equal higher data rates for PHY for 900 and 2400MHz bands

Abstract: The proposed parallel reuse of the 2.4 GHz 802.15.4 modulation technology in PSSS offers highly attractive performance improvement, fulfilling all key OEM requirements, and visibly increasing market opportunities.

Purpose: Proposal for consideration by TG4b

Notice: This document has been prepared to assist the IEEE P802.15. It is offered as a basis for discussion and is not binding on the contributing individual(s) or organization(s). The material in this document is subject to change in form and content after further study. The contributor(s) reserve(s) the right to add, amend or withdraw material contained herein.

Release: The contributor acknowledges and accepts that this contribution becomes the property of IEEE and may be made publicly available by P802.15.

PSSS Proposal

Parallel reuse of 2.4 GHz PHY for the sub-1-GHz bands

Andreas Wolf
(aw@dw-a.com)
Dr. Wolf & Associates GmbH

Hans van Leeuwen
(hvl@sts.nl)
STS

Presentation Contents

- Introduction
 - Changes vs. PSSS presentation at March 2003 meeting (Orlando)
 - Motivation and requirements for TG4b PHY
 - New Specifications for Low Bands
- PHY Performance
- PHY Technology
 - O-QPSK / I/Q and BPSK/ASK
- PHY Implementation aspects
 - Selected Rx implementation options
 - Crystal quality – frequency offset tolerance
 - Linearity
 - Chip size and power consumption
- Status
- PAR compliance
- Summary

Changes vs. PSSS presentation at March 2004 meeting (Orlando)

- **Unchanged proposal for parallel reuse of 2.4 GHz PHY!**
 - Added option of use of BPSK/ASK instead of O-QPSK
 - Based on OEM and semiconductor manufacturers requirements
 - To avoid added complexity and cost for two radio cores
 - To avoid doubling required bandwidth for O-QPSK
 - Added option to reduce 868 Mhz bandwidth to 500 Khz
 - Reduce implementation complexity and cost
 - Achieve still 234 kbit/s
 - Details of combining provided that were not shown in March 2004
 - Coding gain through simple precoding in combiner
- **Added new results on PSSS**
 - Solution performance
 - Implementation aspects
 - Status

Why do we want higher data rate

- Visibly over 200 kbit/s required especially in Europe (i.e. CEPT countries) due to 1% Tx duty cycle limit
 - Prohibits many application from using 868 MHz PHY today
 - Visibly 200 kbit/s would effectively turn limitation for devices into protection against interference from other applications
- Power consumption reduction (if done well)
- Reduced delay for packets
- Better performance and increased scalability for mesh networks
 - Removes today's functional limitations of 868/915 MHz meshes
- Marketing

What is important for the technical selection ?

- Data rate visibly higher than 200 kbit/s – in existing 868 MHz regulation
- Visibly better multipath fading robustness
- Backward compatible to 868/915 MHz PHY – must in IEEE802
- Small implementation, *low* cost – but not *lowest* cost

 *We believe it is key to listen to OEM requirements*

New Specifications for the Low Bands

- We can expect new frequency bands specifications for the sub-1-GHz ISM bands (868, 915 MHz) in Europe and Asia with increased RF bandwidth
 - However, it will take years until the changed SRD band specifications are implemented by all relevant CEPT countries
-
- Therefore 3 forms of *derivative modulations yielding higher data rates¹* are desirable:
 - Higher rate in 915 MHz band
 - Higher rate in existing European band
 - Higher rate in new, upcoming European 863-870 MHz band

1: Scope as defined in PAR

Presentation Contents

- Introduction
 - Changes vs. PSSS presentation at March 2003 meeting (Orlando)
 - Motivation and requirements for TG4b PHY
 - New Specifications for Low Bands



PHY Performance

- PHY Technology
 - O-QPSK / I/Q and BPSK/ASK
- PHY Implementation aspects
 - Selected Rx implementation options
 - Crystal quality – frequency offset tolerance
 - Linearity
 - Chip size and power consumption
- Status
- PAR compliance
- Summary

System characteristics

	IEEE 802.15.4-2003 868 / 915 MHz PHY	PSSS proposal – (March 2004: 8x parallel 2.4 GHz PHY in 868 / 915 MHz)	“Halfrate” proposal
Bandwidth	600 / 2000 Khz	600 (600) / 2000 (2000) kHz	2000 Khz
Chiprate	300 / 600 kcps	300 (500) ¹⁺² / 1000 (2000) ² kcps	1000 kcps
Bitrate	20 / 40 kbit/s	300 (234) ¹⁺² / 1000 (938) ² kbit/s	125 kbit/s
Spectral efficiency	1/15 bit/s/Hz	1/2 (15/32) bit/s/Hz	1/16 bit/s/Hz
Spreading	15 chip sequence	32 chip sequence	32 chip sequence
Channelization	1 / 10 channels	<i>unchanged, 1 / 10 channels</i>	<i>unchanged, 1 / 10 channels</i>
RF backward compatibility	BPSK	(Single BPSK/ASK radio) BPSK + O-QPSK / I/Q	Requires <i>duplicate</i> Rx + Tx cores for BPSK <i>and</i> O- QPSK
Synchronization, clock recovery	BPSK	(Single BPSK/ASK radio) BPSK + O-QPSK / I/Q	Required <i>twice</i> for BPSK <i>and</i> O-QPSK

“(…)” Proposed options of PSSS proposal – Changes are 1: Reduce EU signal bandwidth, 2: Use BPSK/ASK

System performance

	PSSS proposal	“Halfrate” proposal
Coding gain (vs. coherent BPSK, at 10^{-5} BER)	$\approx 1...3$ dB	≈ 1 dB
Target for MP fading robustness	Tolerates 1...2 μ s frequency selective multipath fading (coding immanent)	“> 100 ns” (Source: 01229r1, Motorola)
Loss in link budget due to MP fading (RMS 400ns) - 10^{-2} PER - 10^{-3} PER	$\approx -8...9$ dB $\approx -8...9$ dB	≈ -18 dB > 32 dB
MP fading range & Coverage	Range 2...4x better than Halfrate → <i>Very small holes in coverage</i>	→ <i>Significant holes in coverage</i>
Practical Rx sensitivity (0.18 μ CMOS)	Better than -94 dB	

Multipath PHY Simulation

- Detection based on largest correlation peak (largest path) ... No RAKE or equalizer.
- Assume channel is constant throughout packet (quasi-static) and uncorrelated from packet to packet.
- Record average packet error rate (PER) vs. E_b/N_o .

Two Multipath Models

- Two analytical multipath channel models are defined for evaluating optional sub-GHz PHY performance.
- Diffuse exponential model
 - Presented in 802.11 Handbook [1] and recommended for narrowband systems by TG3a channel modeling sub-committee [2]
 - Preferred for baseband simulations
- **Discrete exponential model**
 - **Sampled version of diffuse model**
 - **Acceptable alternative for simulations with high sampling rates**
 - **At least 1000 random channel realizations for each PER value.**

**Used models
reference for
benchmarking**

Selected Method

Halfrate MP fading performance – Diffuse exponential model

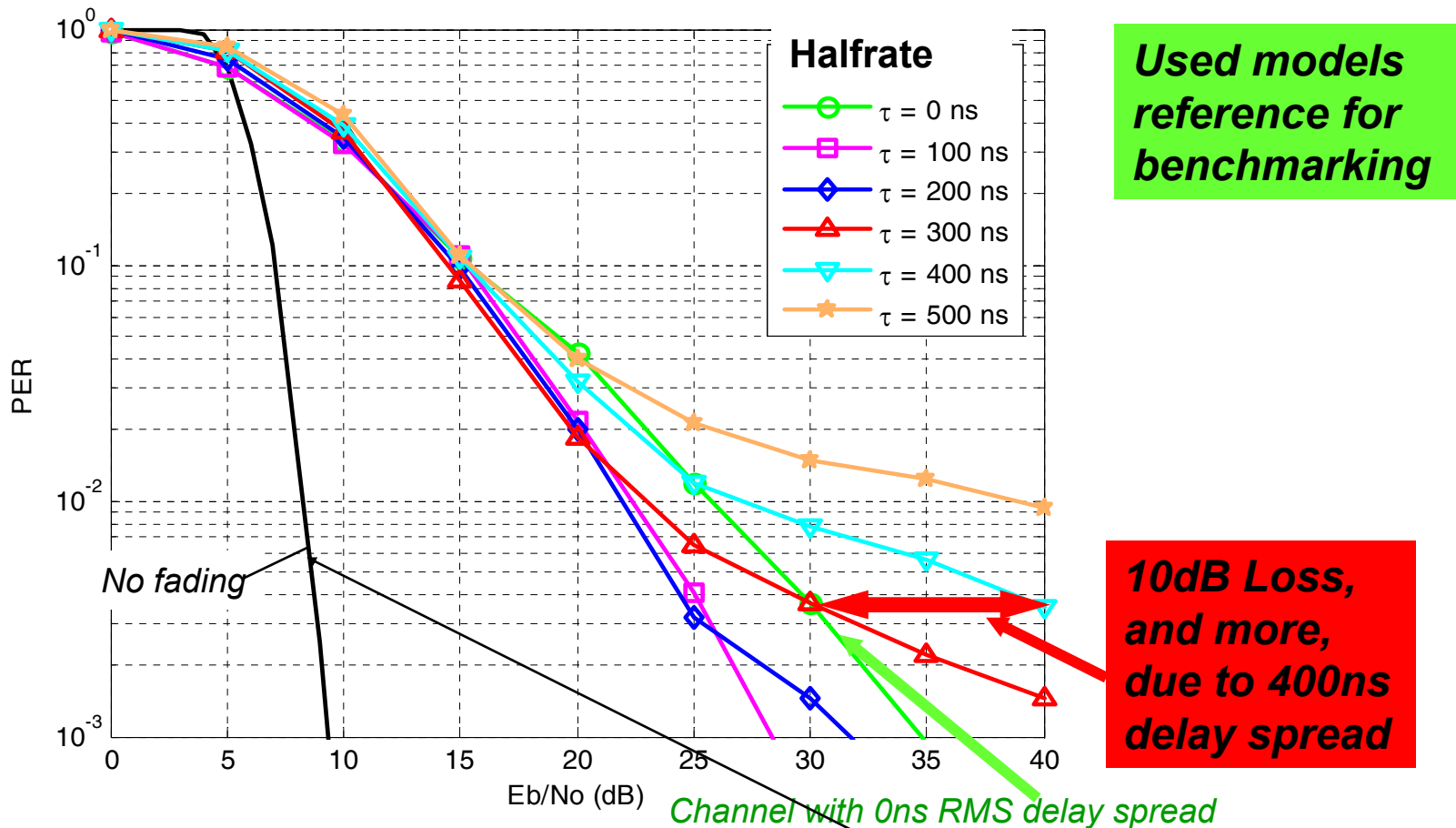

Used Matlab Code for Discrete Channel

```
L=2
% L=2 equal 370 ns RMS Delay Spread
profile = zeros(1,10*L+1);
profile(1:L:end) = exp(-(0:10)/2);
profile = profile/(sum(profile));
channel = sqrt(profile/2).*(randn(size(profile))+j*randn(size(profile)));
signal_out = zeros(size(signal_in));
for k = 0:10
    signal_out=signal_out+channel(k+1)*[zeros(1,k*L) signal_in(1:length(signal_in)-k*L)];
end
```

***Used models
reference for
benchmarking***

Channel Reponse Simulated about 1429 Frames

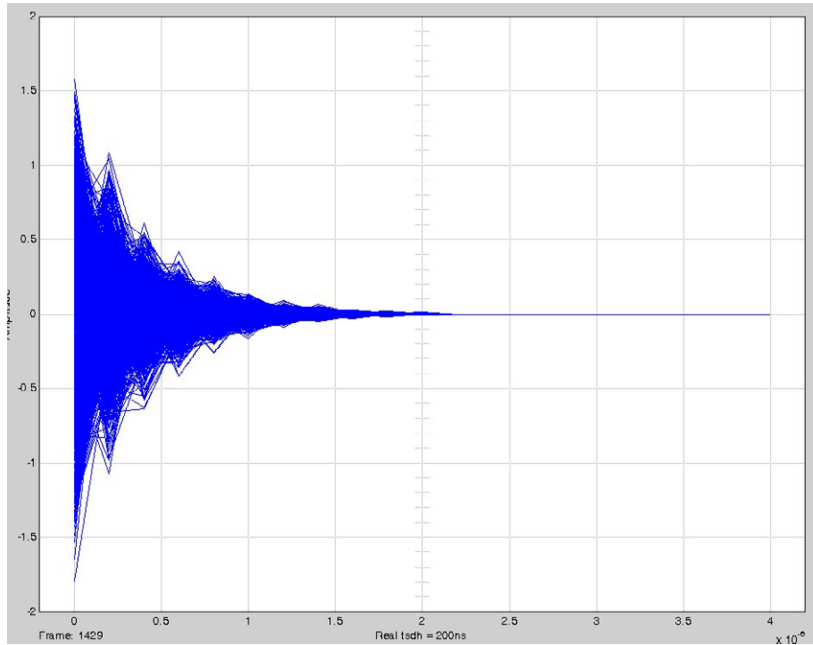

Real Part

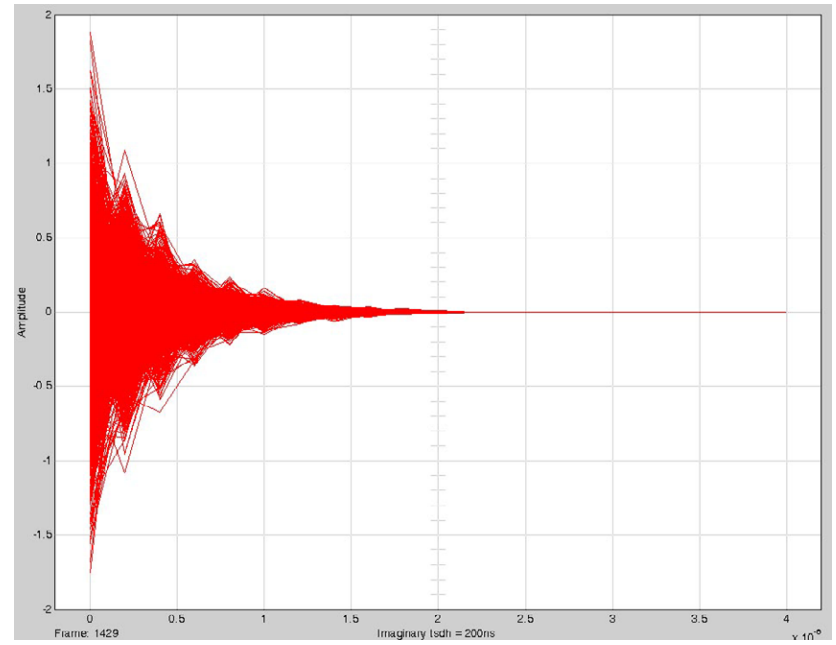

Imaginary Part

PER Performance Discrete Exponential Channel 370ns RMS Delay Spread

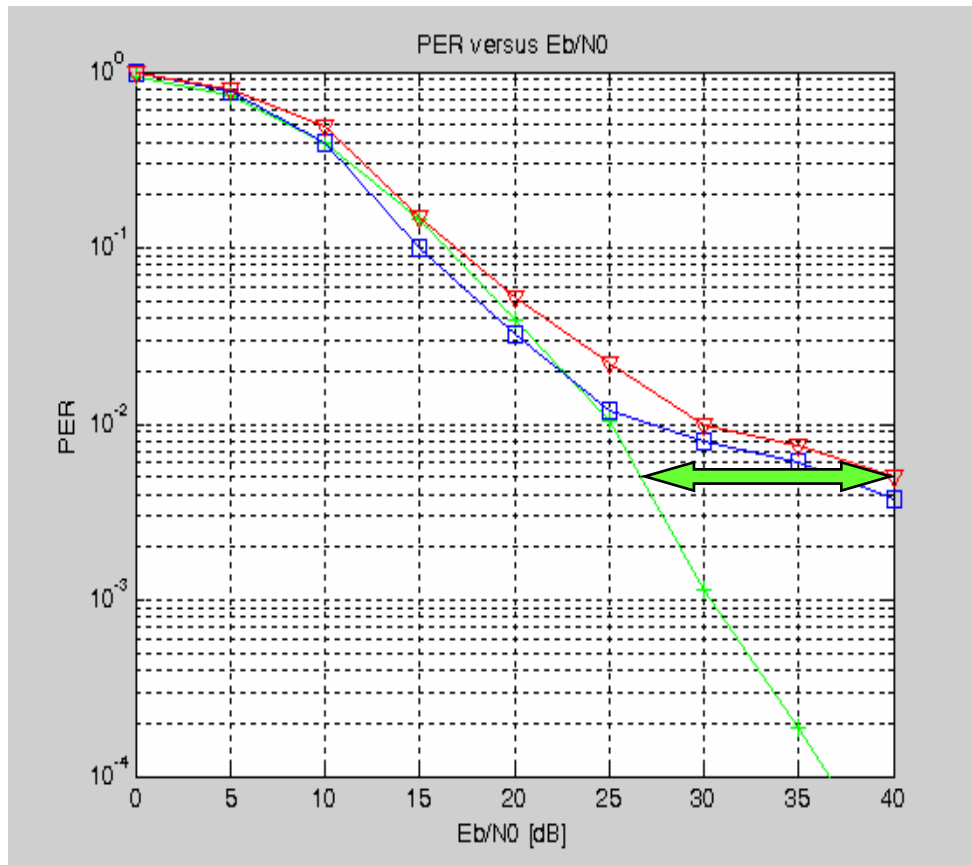

- PSSS 234 kbit/s

- COBI16 235 kbit/s

- Halfrate

(reference IEEE 15-04-337-00-004b, Motorola, 400ns RMS delay spread)

PSSS has best performance without complex rake receiver!!!

> 10000 Channel, no Rake Receiver

Presentation Contents

- Introduction
 - Changes vs. PSSS presentation at March 2003 meeting (Orlando)
 - Motivation and requirements for TG4b PHY
 - New Specifications for Low Bands
- PHY Performance
-  **PHY Technology**
 - O-QPSK / I/Q and BPSK/ASK
- PHY Implementation aspects
 - Selected Rx implementation options
 - Crystal quality – frequency offset tolerance
 - Linearity
 - Chip size and power consumption
- Status
- PAR compliance
- Summary

Current 2.4 GHz / Halfrate PHY Tx architecture (1/16 Bit/s/Hz)

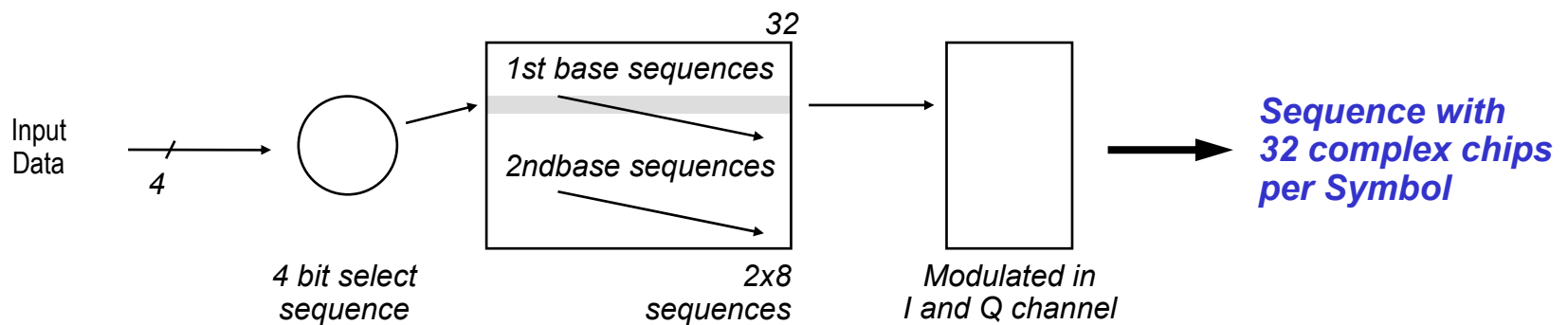
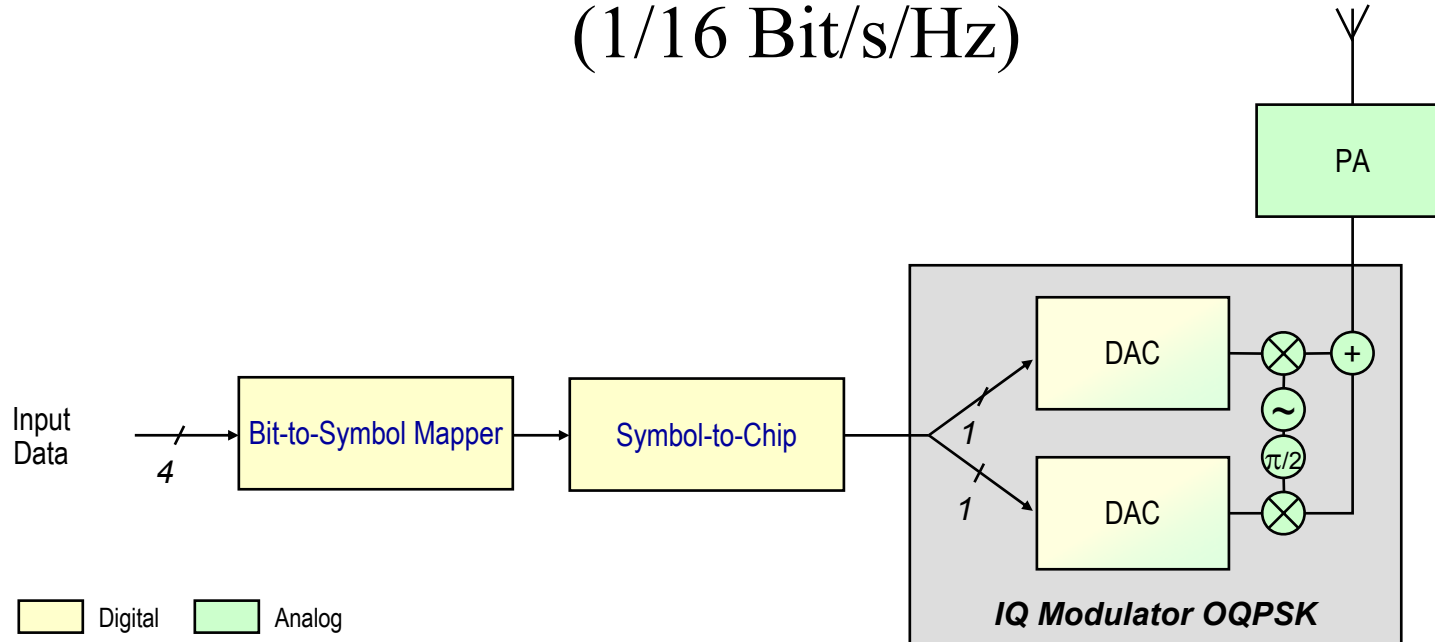

PSSS - 8 Times parallel 2.4 GHz PHY derivate – Tx - Original O-QPSK / I/Q proposal (1/2 bit/s/Hz)

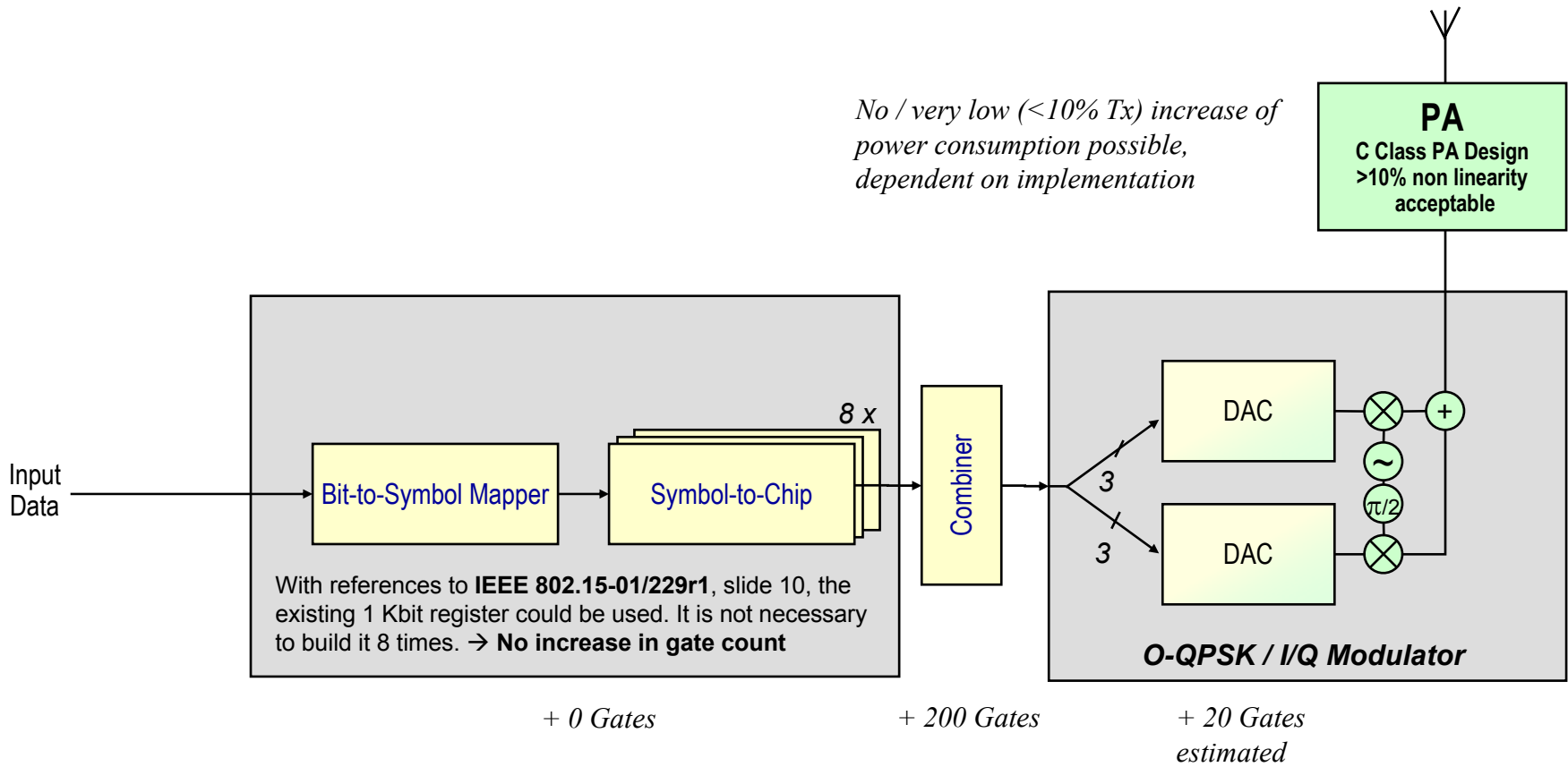

Digital Analog

PSSS - 8 Times parallel 2.4 GHz PHY derivate – Tx - Original O-QPSK / I/Q proposal (1/2 bit/s/Hz)

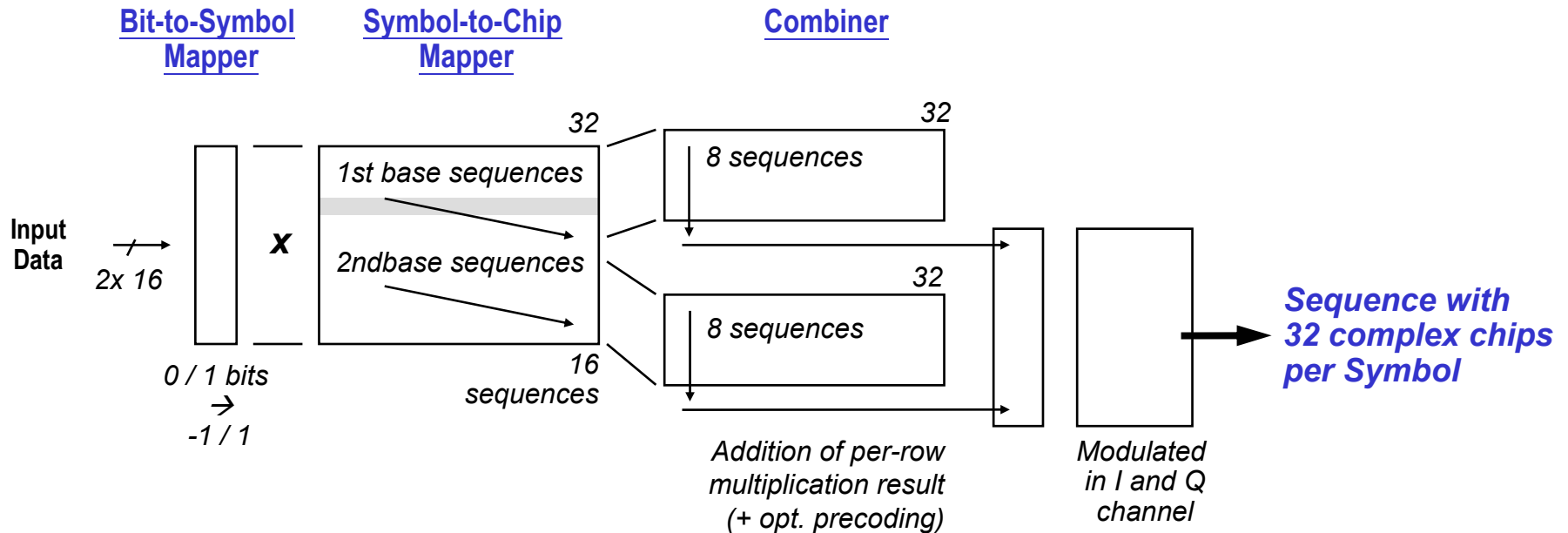

...addition of multiple parallel sequences instead of selection of single sequence

PSSS – Tx – BPSK/ASK option (15/32 bit/s/Hz)

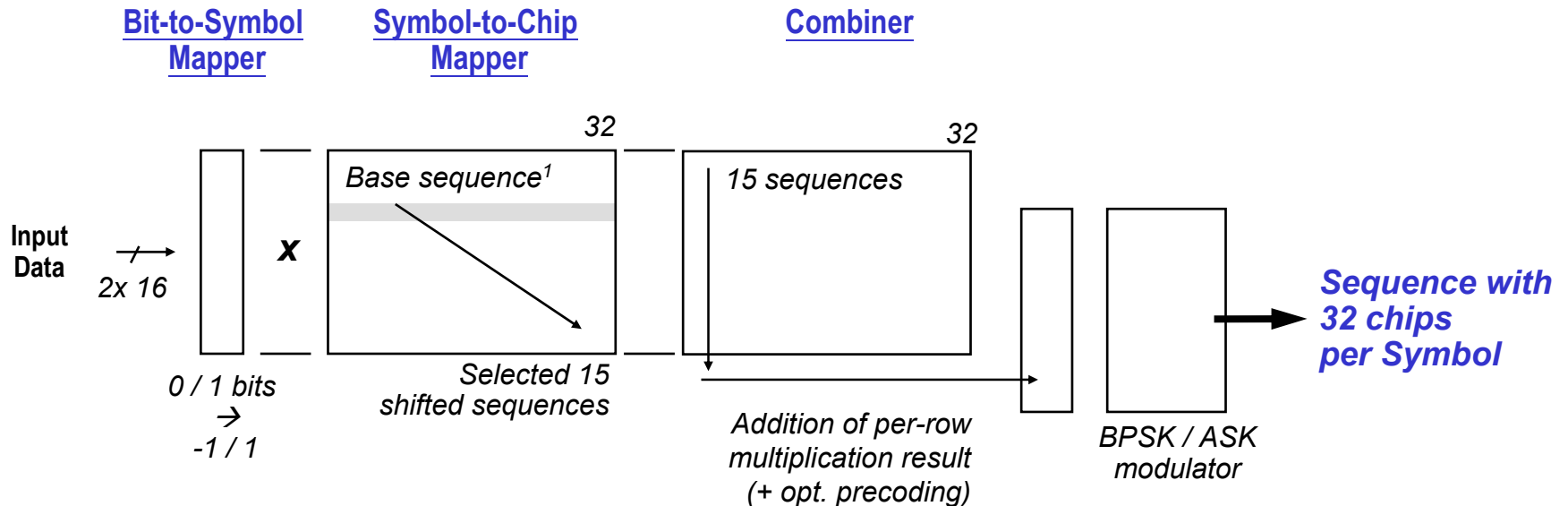

...addition of multiple parallel sequences instead of selection of single sequence

1: Use of single base sequence simplifies implementation in Rx

PSSS –BPSK/ASK option (15/32 bit/s/Hz) – Coding table

Symbol-to-Chip Mapper

# Bit	Chip Values																																			
1	-1	-1	-1	-1	1	-1	-1	1	-1	1	1	-1	-1	1	1	1	1	-1	-1	-1	1	1	-1	1	1	1	-1	1	-1	1	-1	1	-1	1	-1	
2	-1	1	-1	-1	-1	-1	1	-1	-1	1	-1	1	1	-1	-1	1	1	1	1	-1	-1	-1	1	1	-1	1	1	-1	1	1	1	-1	1	-1	1	-1
3	-1	1	-1	1	-1	-1	-1	1	-1	-1	1	-1	1	1	-1	-1	1	1	1	1	-1	-1	-1	1	1	-1	-1	1	1	-1	1	1	1	1	-1	
4	1	1	-1	1	-1	1	-1	-1	-1	-1	1	-1	-1	1	-1	1	1	-1	-1	1	1	1	1	1	-1	-1	-1	1	1	-1	1	1	-1	1	1	
5	-1	1	1	1	-1	1	-1	1	-1	-1	-1	-1	1	-1	-1	1	1	-1	-1	1	1	1	1	1	1	-1	-1	-1	1	1	-1	1	1	-1	1	-1
6	1	1	-1	1	1	1	-1	1	-1	1	-1	-1	-1	1	-1	-1	1	-1	1	1	-1	-1	1	1	1	1	1	1	1	1	1	1	-1	-1	-1	1
7	-1	-1	1	1	-1	1	1	1	-1	1	-1	1	-1	-1	-1	1	-1	-1	1	-1	1	1	-1	-1	1	1	1	-1	-1	1	1	1	1	1	-1	-1
8	1	-1	-1	-1	1	1	-1	1	1	1	-1	1	-1	1	-1	-1	-1	1	-1	-1	1	1	-1	-1	1	1	-1	-1	1	1	-1	1	1	1	1	1
9	1	1	1	-1	-1	-1	1	1	-1	1	1	1	-1	1	-1	-1	-1	-1	1	-1	-1	1	-1	1	-1	1	1	-1	-1	1	1	-1	-1	1	1	1
10	1	1	1	1	1	-1	-1	-1	1	1	-1	1	1	-1	1	-1	1	-1	-1	-1	1	-1	-1	1	-1	-1	1	-1	-1	1	1	-1	1	-1	-1	1
11	-1	-1	1	1	1	1	1	-1	-1	-1	1	1	-1	1	1	1	-1	1	-1	1	-1	-1	-1	1	-1	-1	-1	1	-1	-1	1	-1	1	1	1	-1
12	1	1	-1	-1	1	1	1	1	1	-1	-1	-1	1	1	-1	1	1	1	-1	1	-1	-1	-1	-1	-1	-1	-1	1	-1	-1	1	-1	-1	1	-1	1
13	1	-1	1	1	-1	-1	1	1	1	1	1	-1	-1	-1	1	1	-1	1	1	1	-1	1	-1	1	-1	-1	-1	-1	-1	-1	-1	-1	-1	-1	-1	-1
15	-1	-1	1	-1	1	1	-1	-1	1	1	1	1	1	-1	-1	1	1	-1	1	1	1	-1	1	-1	1	-1	1	-1	1	-1	-1	-1	-1	-1	-1	-1
15	-1	1	-1	-1	1	-1	1	1	-1	-1	1	1	1	1	1	-1	-1	-1	1	1	-1	1	1	1	-1	1	1	-1	1	-1	1	-1	-1	-1	-1	-1
	1	2	3	4	5	6	7	8	9	10	11	12	13	14	15	16	17	18	19	20	21	22	23	24	25	26	27	28	29	30	31	32				

PSSS –BPSK/ASK option (15/32 bit/s/Hz) – Precoding

1. Align PSSS symbol maxima symmetrical to 0
2. Scale PSSS symbol to amplitude limit

Minimal Resolution after precoding: 5 bit

Note:

Higher resolution further improves performance, but does not limit interoperability

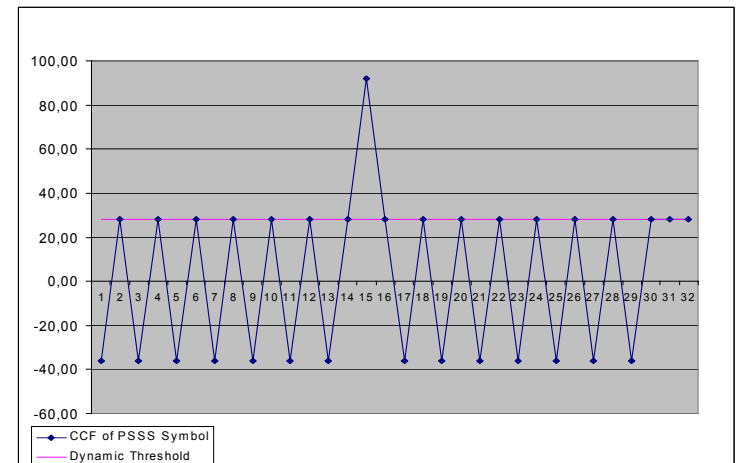
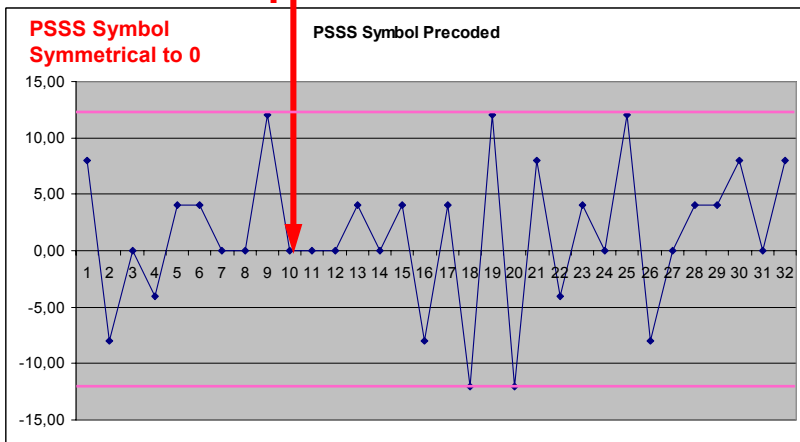
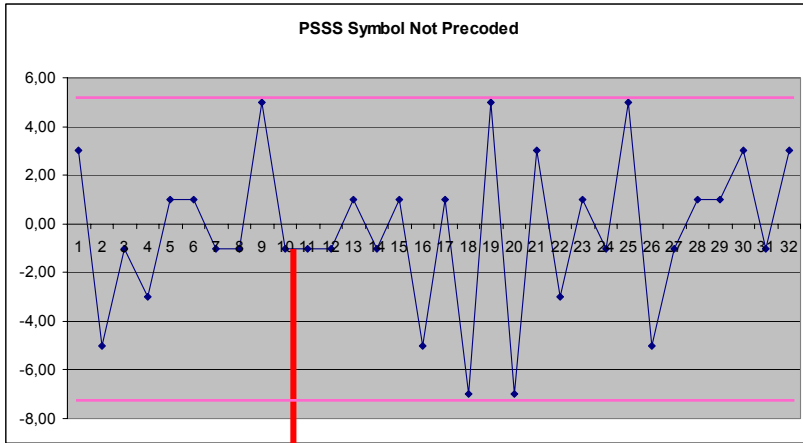

Tx

Rx

PSSS Amplitude Histogram With Precoding

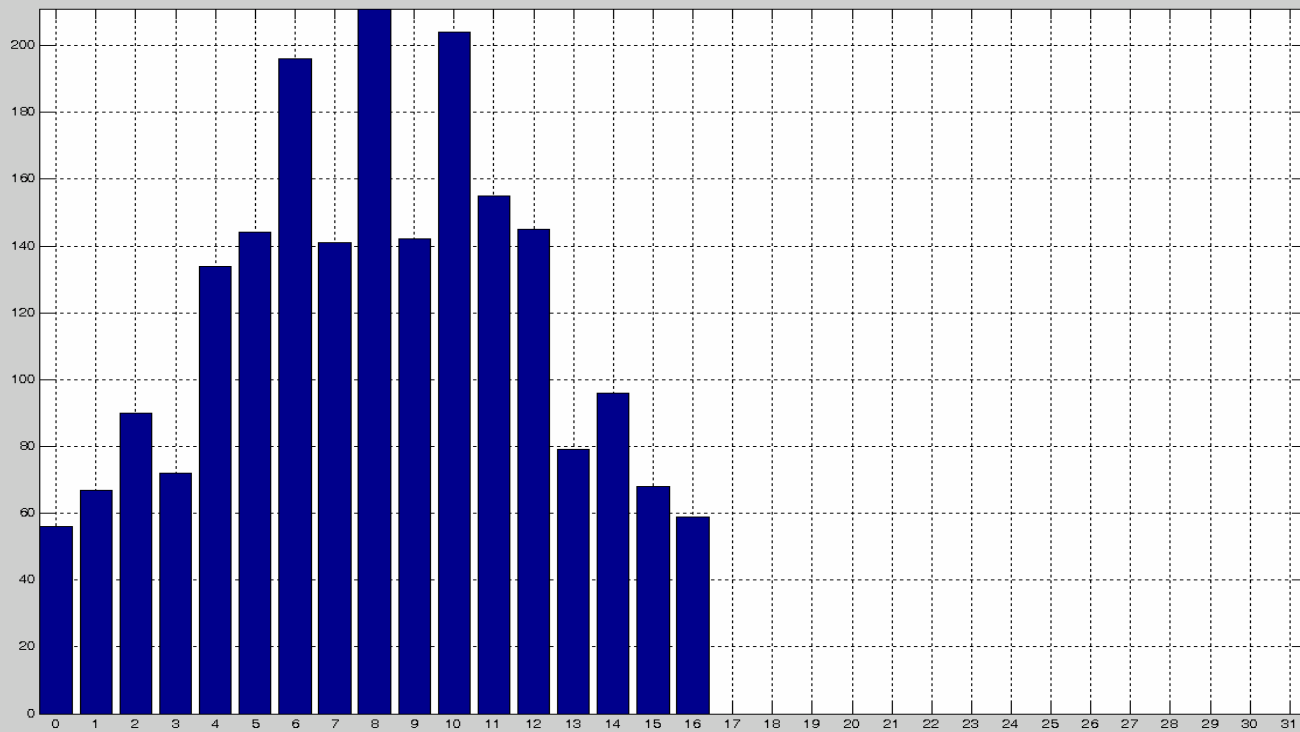

17 levels -> 5 bit resolution

Presentation Contents

- Introduction
 - Changes vs. PSSS presentation at March 2003 meeting (Orlando)
 - Motivation and requirements for TG4b PHY
 - New Specifications for Low Bands
- PHY Performance
- PHY Technology
 - O-QPSK / I/Q and BPSK/ASK
-  PHY Implementation aspects
 - Selected Rx implementation options
 - Crystal quality – frequency offset tolerance
 - Linearity
 - Chip size and power consumption
- Status
- PAR compliance
- Summary

2.4 GHz PHY – Rx architecture example (1/16 Bit/s/Hz)

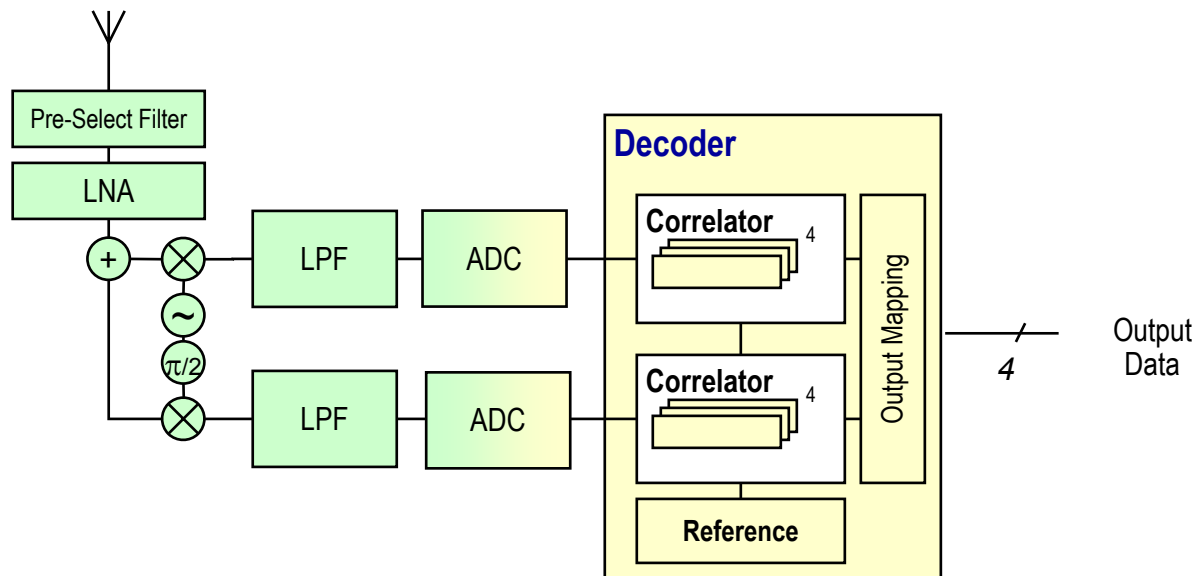

Legend: Digital Analog

Note:

Most existing IEEE802.15.4 2.4 GHz chips are built with ≥ 4 -bit ADCs

PSSS - 8 Times parallel 2.4 GHz PHY derivate – Rx: Original O-QPSK / I/Q proposal (1/2 bit/s/Hz) – Digital correlation example

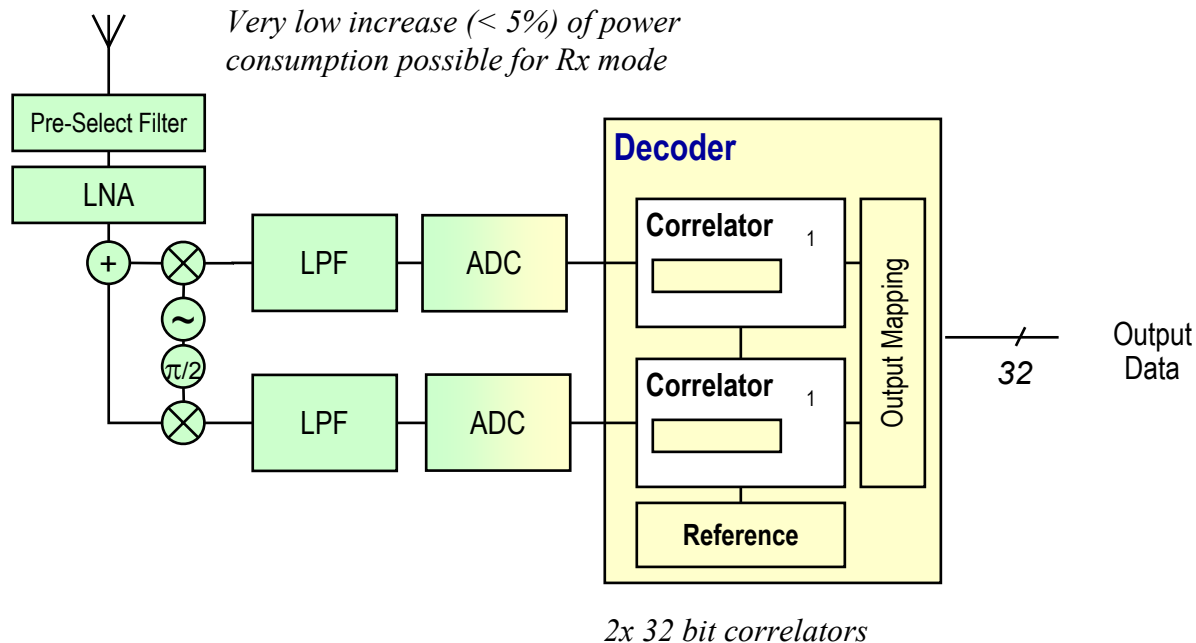

Digital
 Analog

Note:

Most existing IEEE802.15.4 2.4 GHz chips are built with ≥ 4 -bit ADCs

PSSS - 8 Times parallel 2.4 GHz PHY derivate – Rx: Original O-QPSK / I/Q proposal (1/2 bit/s/Hz) – Analog correlation example

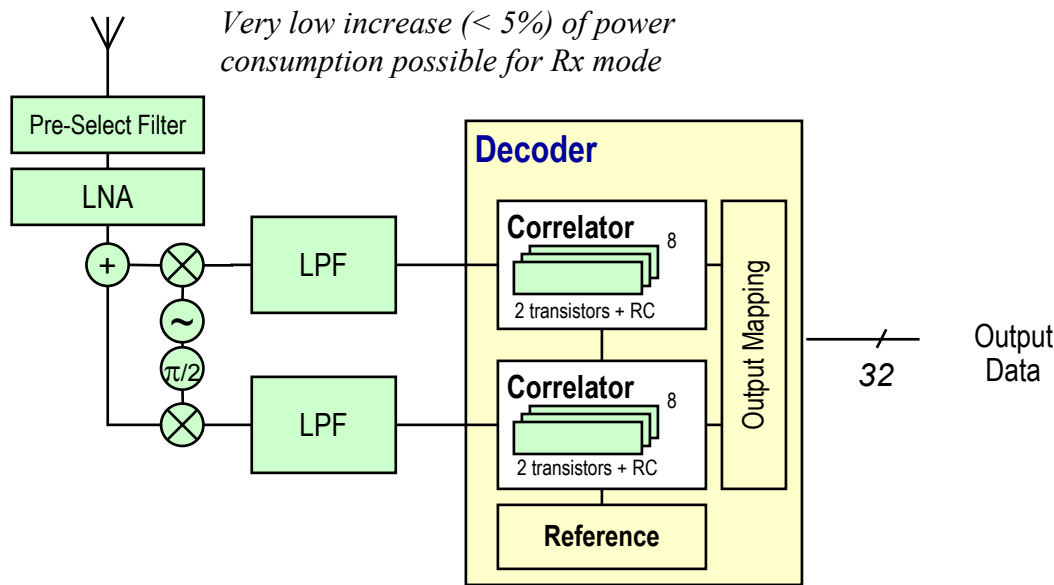

No ADCs vs. Halfrate

16 analogue integrate & dump, approx. 5-10k gates reduction (no 2x 4x32 bit correlators)

Note:
 The Rx example architectures shown (digital, analog, FIR correlator) and the modulation variant can be freely combined

Digital
 Analog

PSSS - 8 Times parallel 2.4 GHz PHY derivate – Rx - BPSK/ASK option (15/32 bit/s/Hz) – FIR filter correlation example

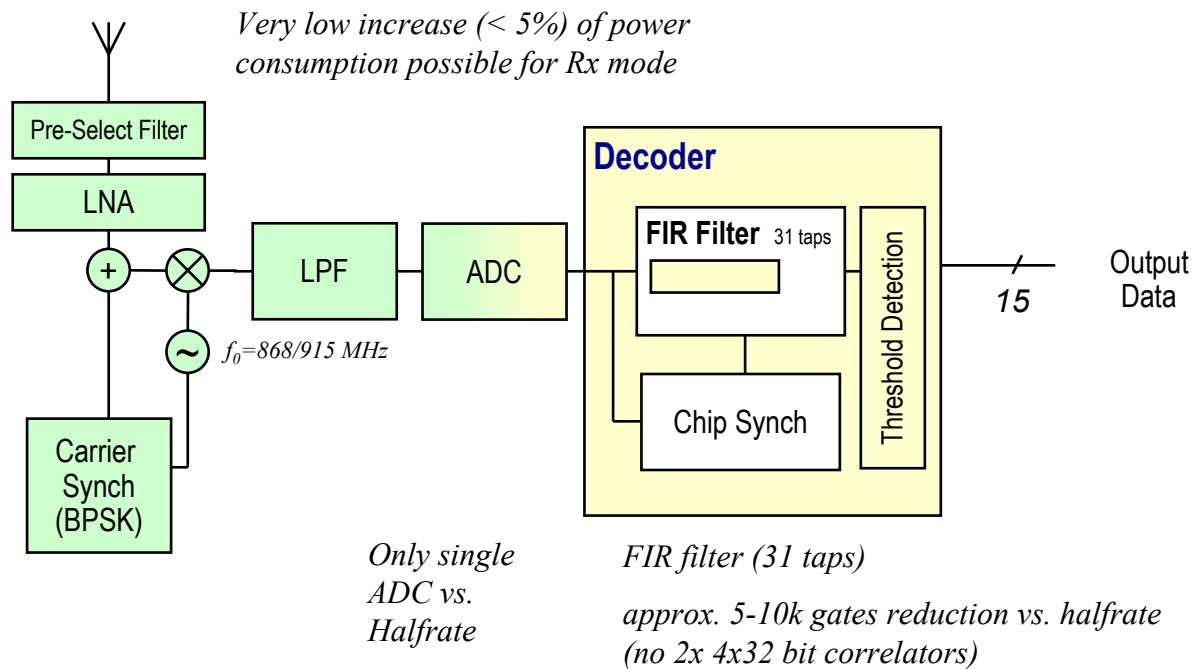

Digital
 Analog

Crystal quality – Tolerated frequency offset

- Performance against frequency offset –
Original target in TG4: Up to $\pm 40\text{ppm}$
 - Assumptions for chip clock:
 - PDU length 127 Byte = $8 \cdot 127$ bit = 1016 bit
 - 15 bit per PSSS Symbol (32 chip)
 - \rightarrow 68 PSSS Symbols with 2176 chips (Chip duration $T_c = 2\mu\text{s}$)
 - Results
 - 40ppm for 2176 chips = 0.087 chip error for the whole PDU
 - For one PSSS Symbol with 32 chips
the error is about $40\text{ppm} \cdot 32$ chip = 0,00128 chip

 **No influence to PSSS Performance by $\pm 40\text{ppm}$ and worse crystal**

Crystal quality – Tolerated frequency offset – Measurements from PSSS prototype

0.1% Chip Clock Error

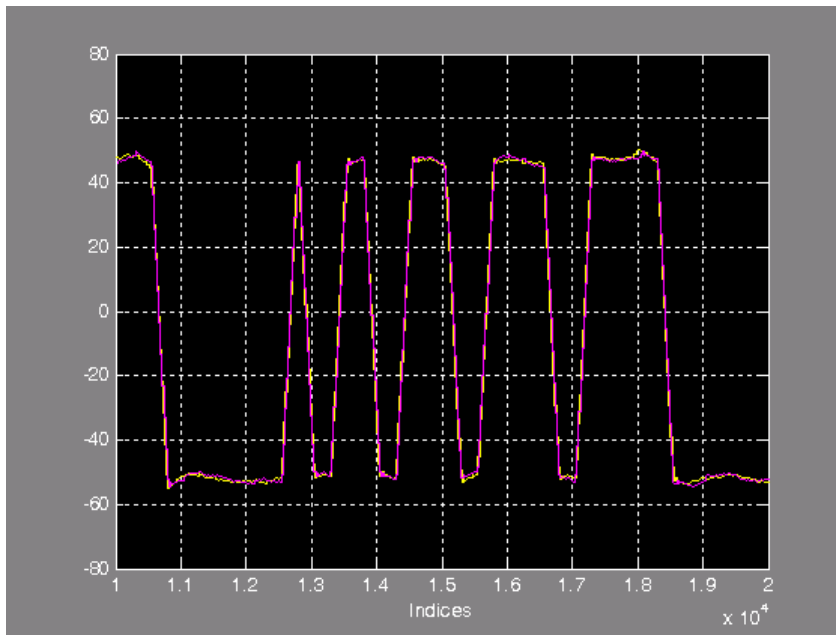

1% Chip Clock Error

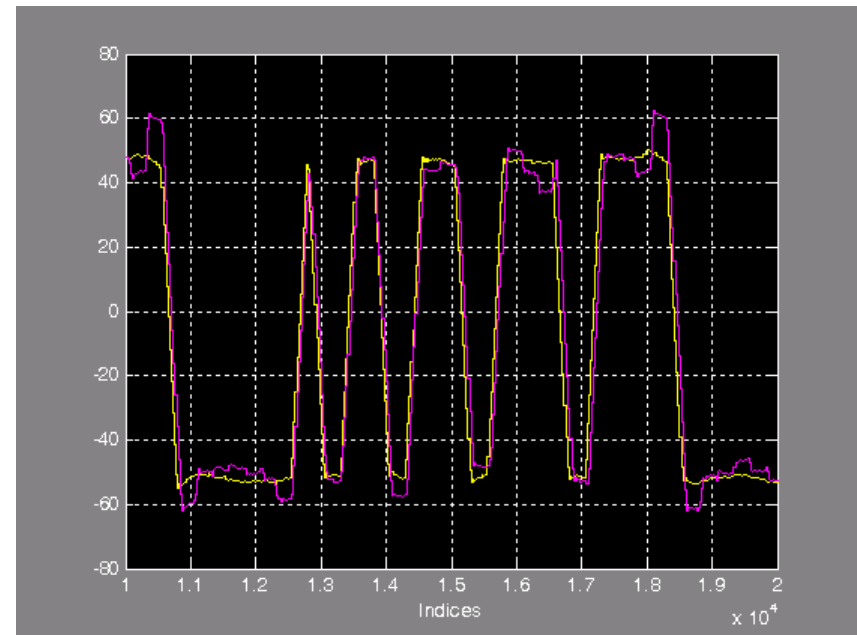

Yellow: 0% chip clock error reference signal
Pink: 0.1% and 1% chip clock error



Calculation of crystal quality tolerance confirmed with prototype

Linearity – Transfer function for non-linear system simulated

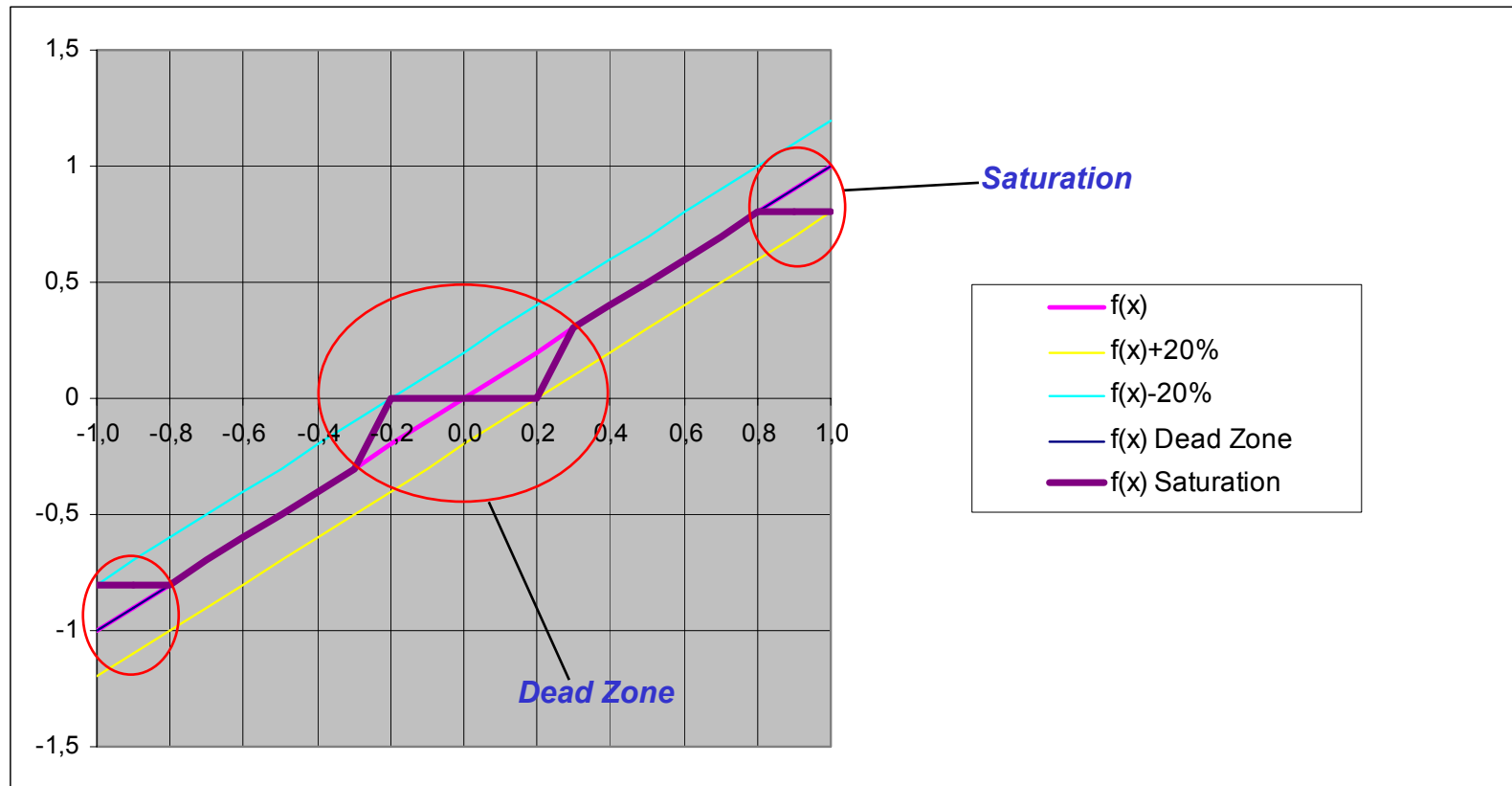

Linearity – Simulation results

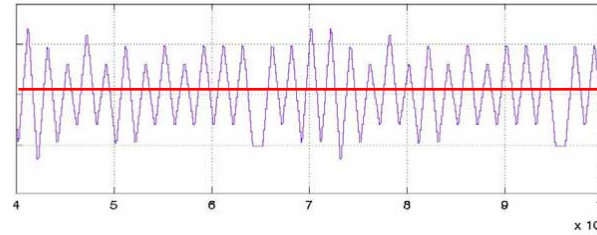
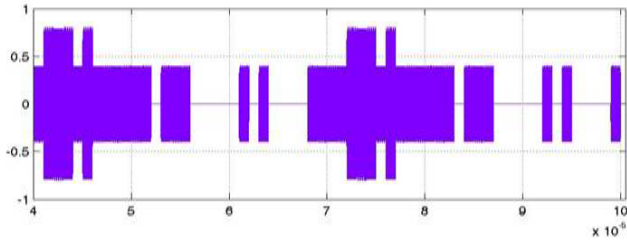

20% non-linearity

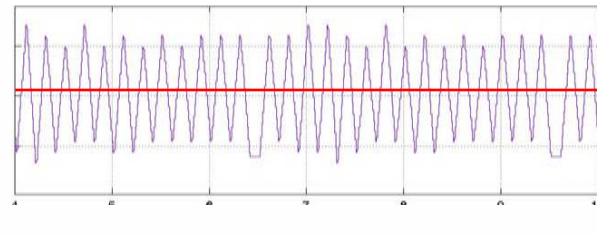
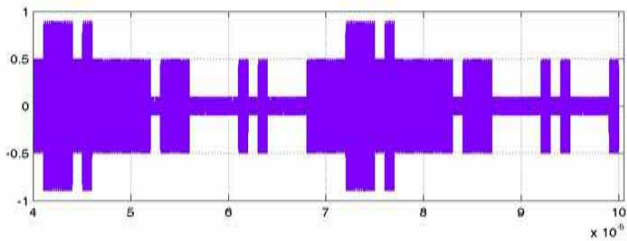

10% non-linearity

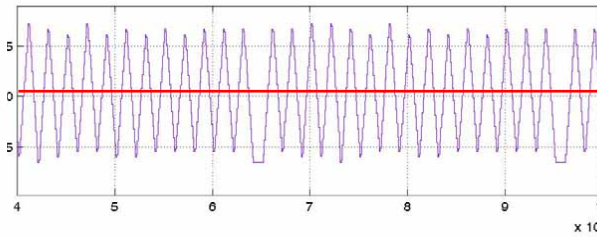
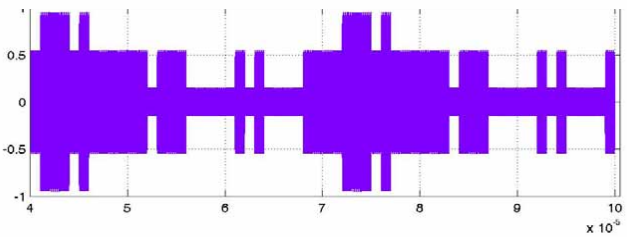

5% non-linearity

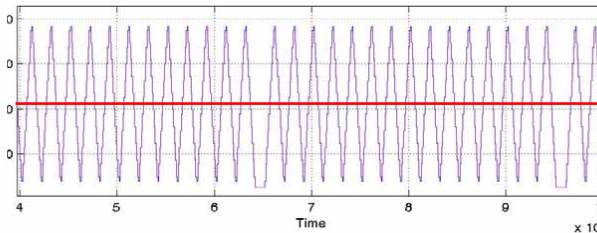
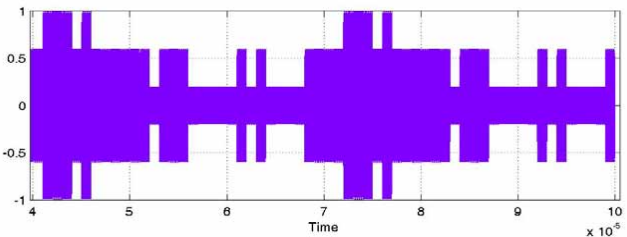

0% non-linearity

— Detection threshold (for '0' or '1' data bits)

Notes PSD Simulations

- Actual bandwidth for PSD 16 kHz simulation
- Conform to ETSI recommendations

Simulation Model 1

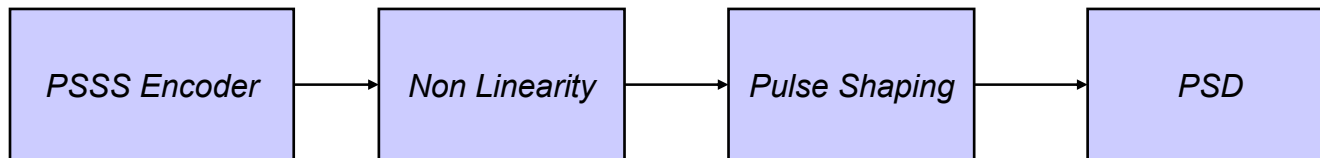

Non Linear Transfer Function

Used transfer function for simulating PSD for non linearity

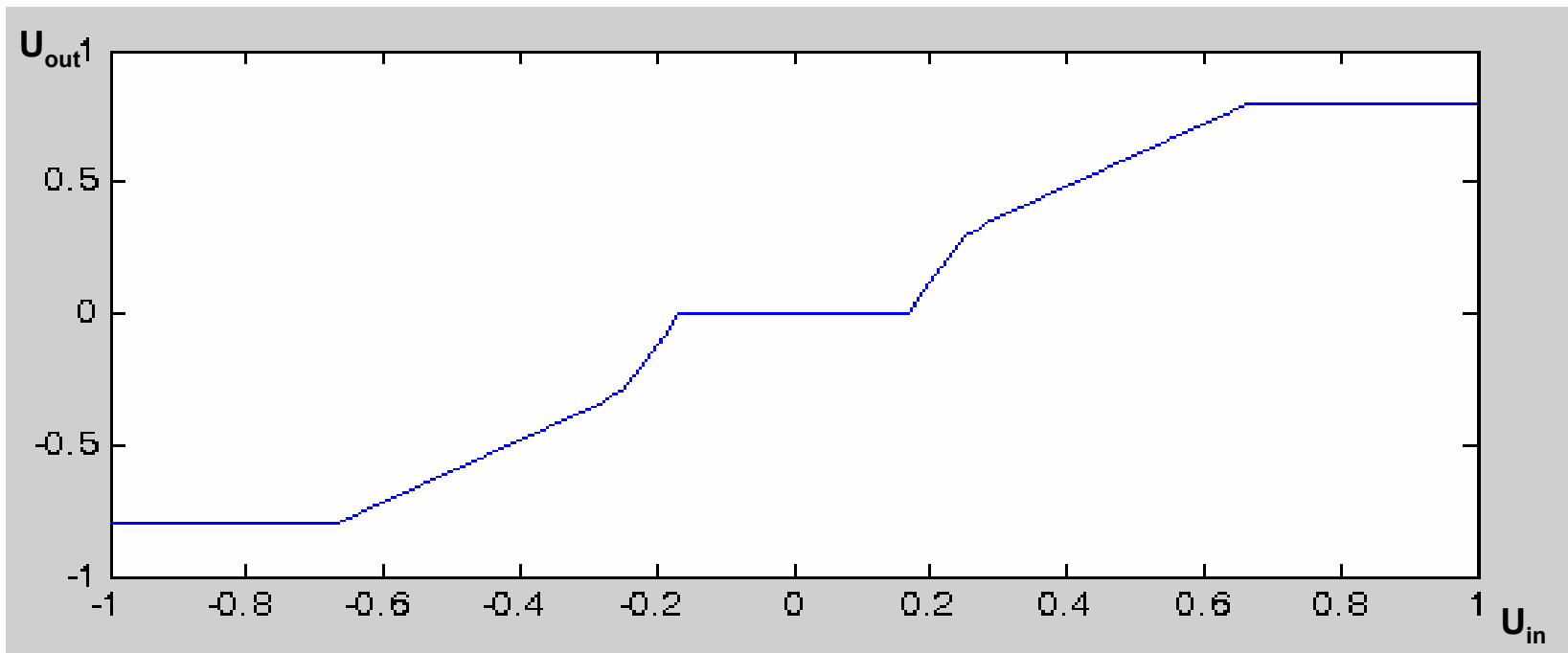

PSD PSSS Signal

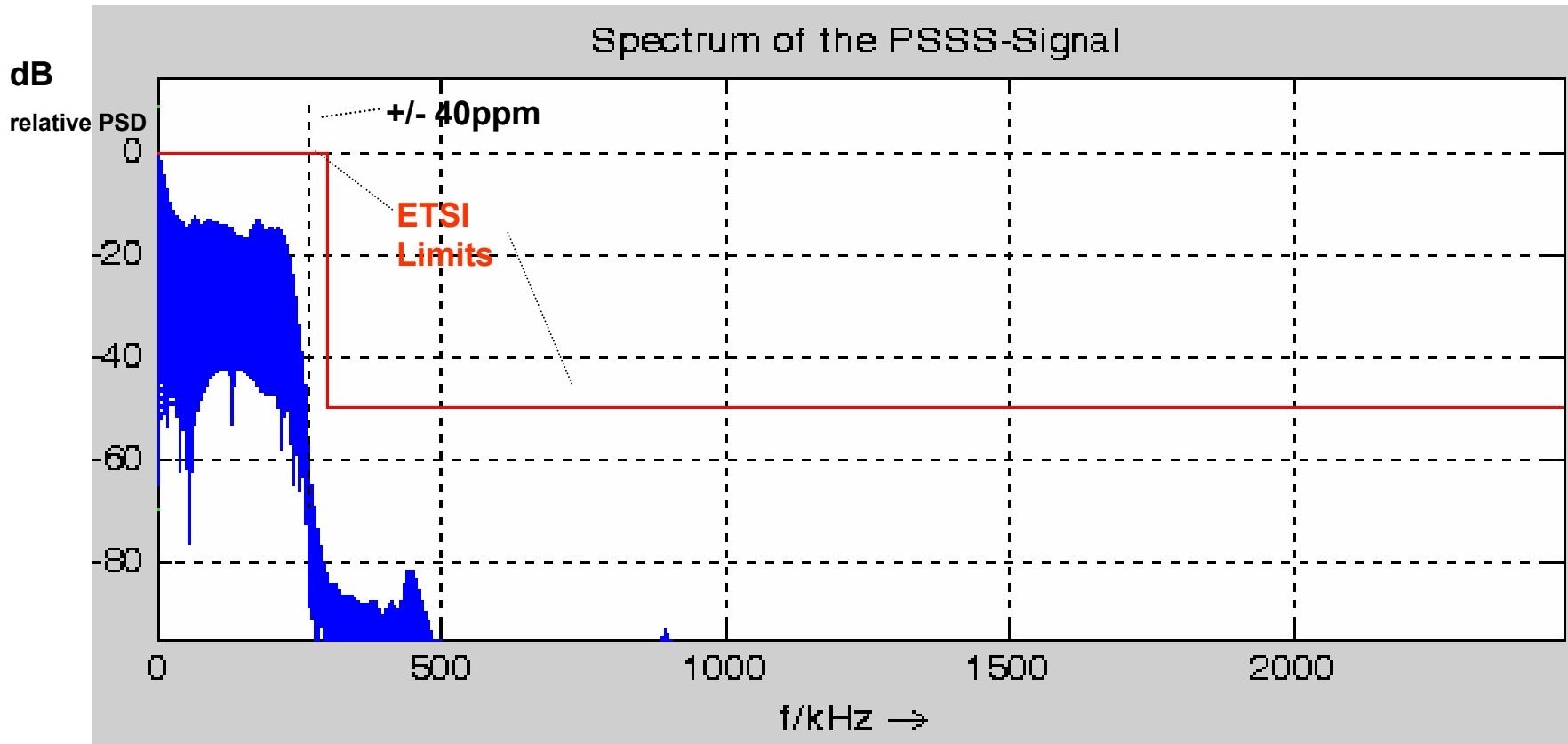

**Simulations of the relative PSD in dB for the PSSS signal at 450 kchips/s, 210 kbit/s, +/- 40ppm.
Conditions: linear, no precoding**

PSD PSSS Signal

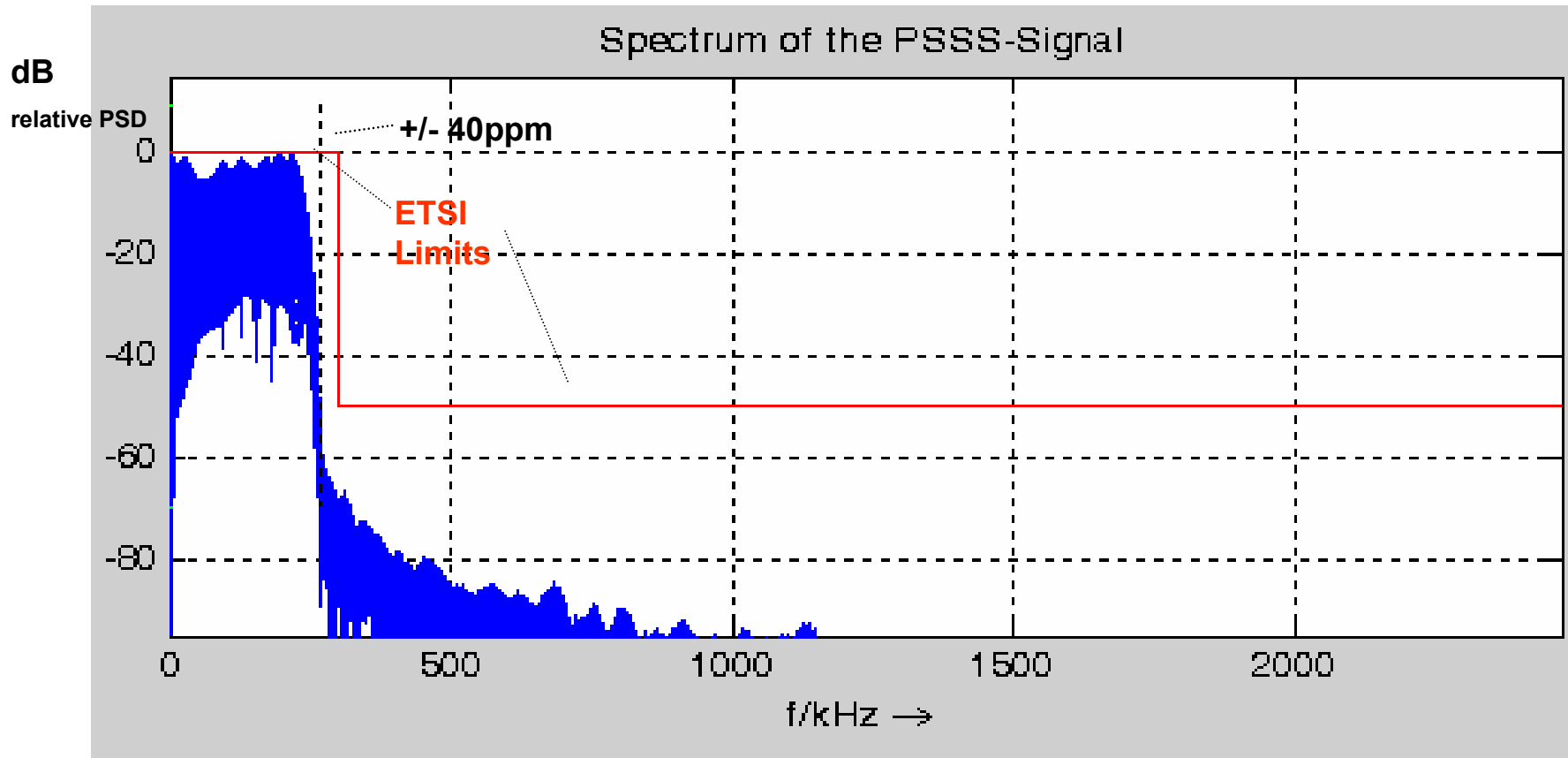

Simulations of the relative PSD in dB for the PSSS signal at 450 kchips/s, 210 kbit/s, +/- 40ppm.
Conditions: linear, precoding

PSD PSSS Signal

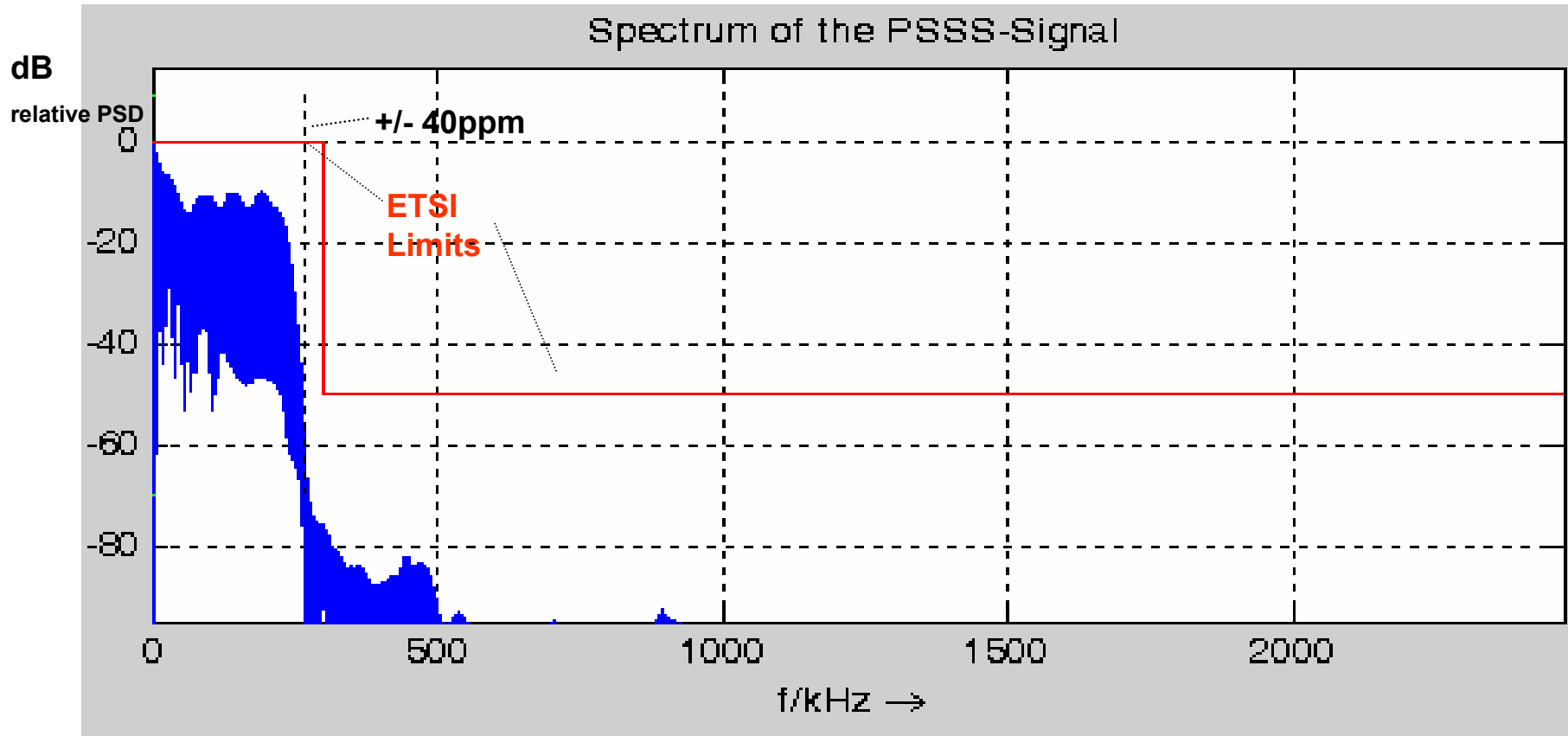

Simulations of the relative PSD in dB for the PSSS signal at 450 kchips/s, 210 kbit/s, +/- 40ppm.
Conditions: non linear, no precoding

PSD PSSS Signal

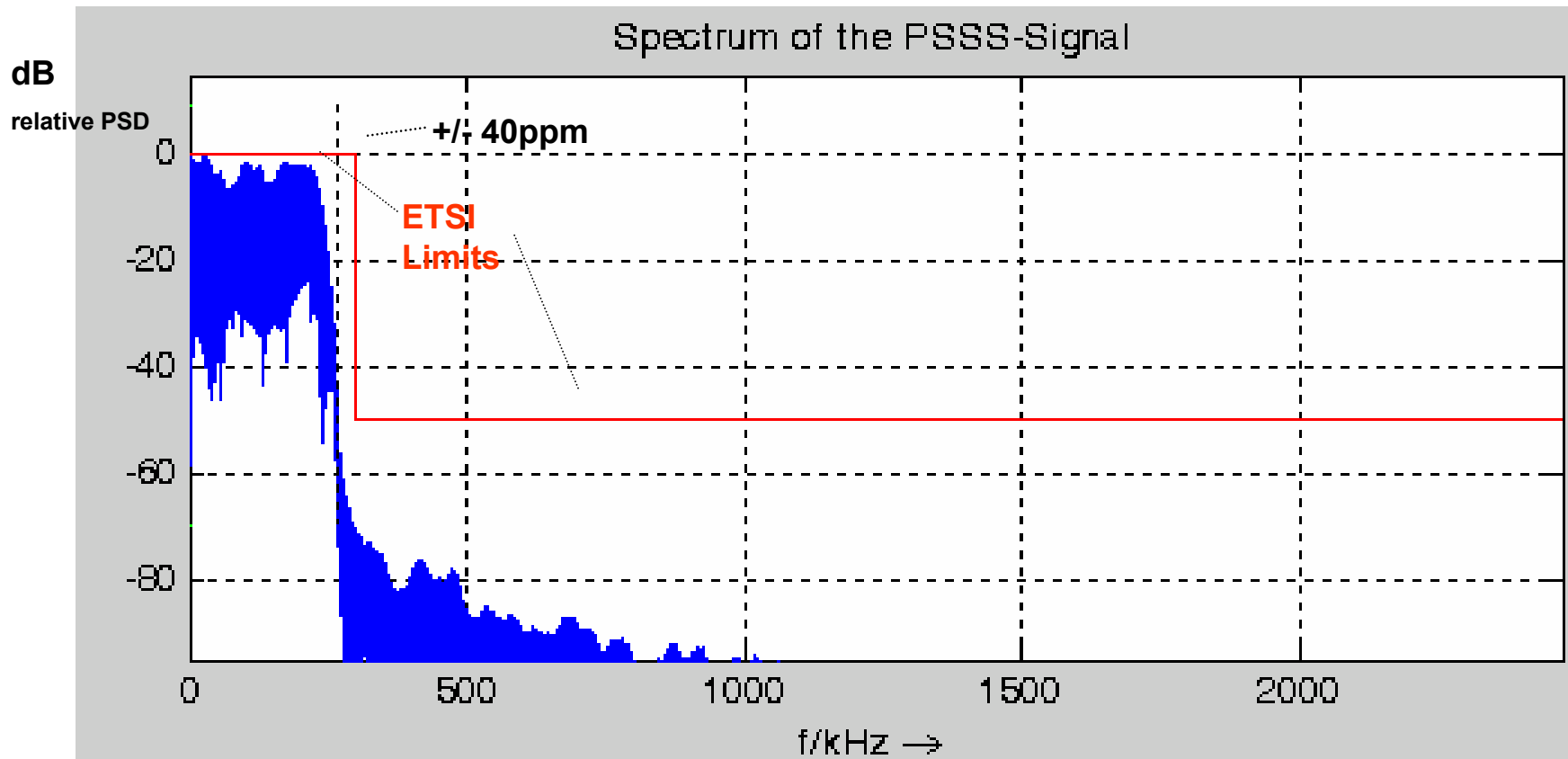

Simulations of the relative PSD in dB for the PSSS signal at 450 kchips/s, 210 kbit/s, +/- 40ppm.
Conditions: non linear, precoding

PSD PSSS Signal

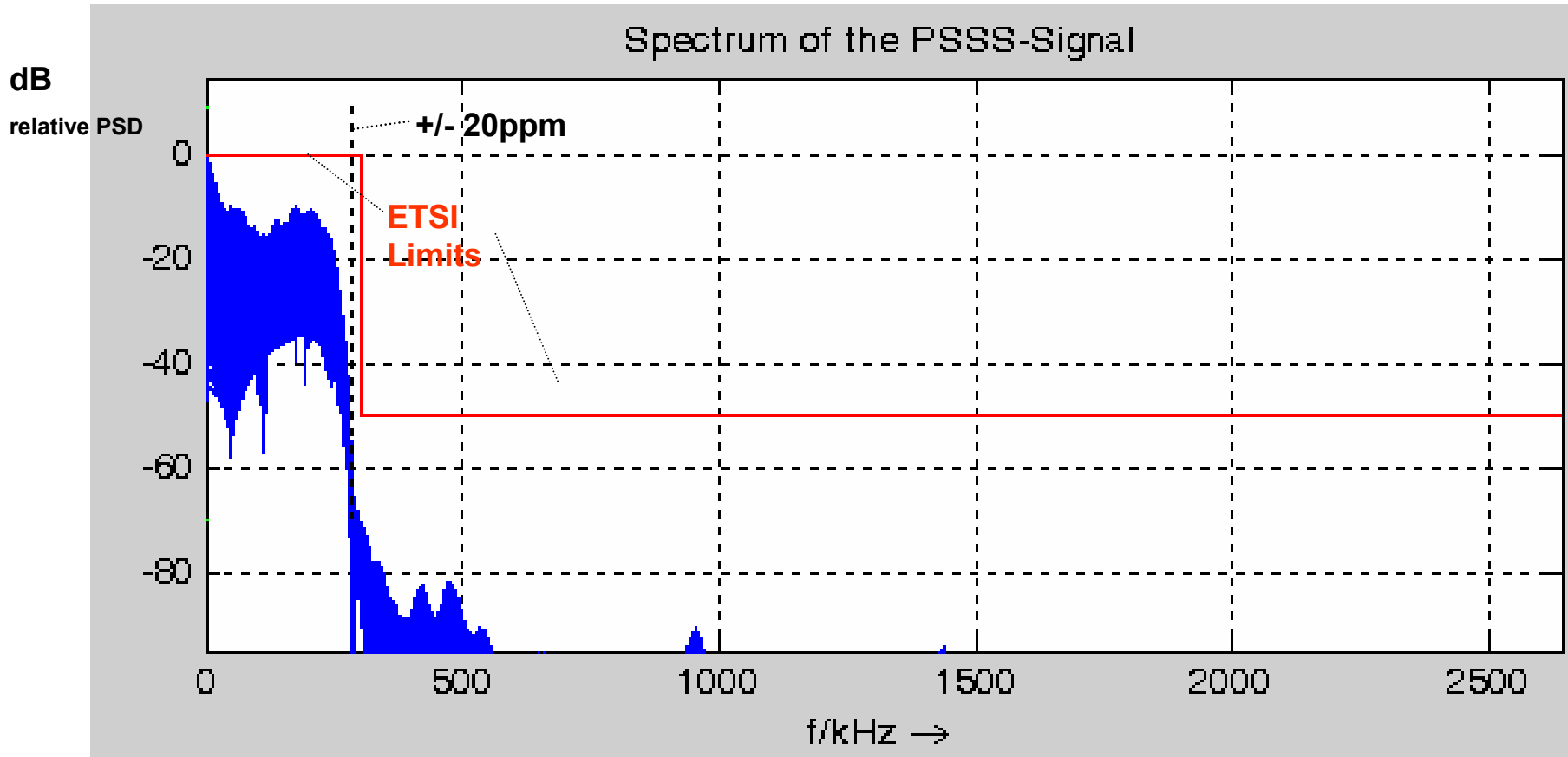

Simulations of the relative PSD in dB for the PSSS signal at 480 kchips/s, 225 kbit/s, +/- 20ppm.
Conditions: linear, no precoding

PSD PSSS Signal

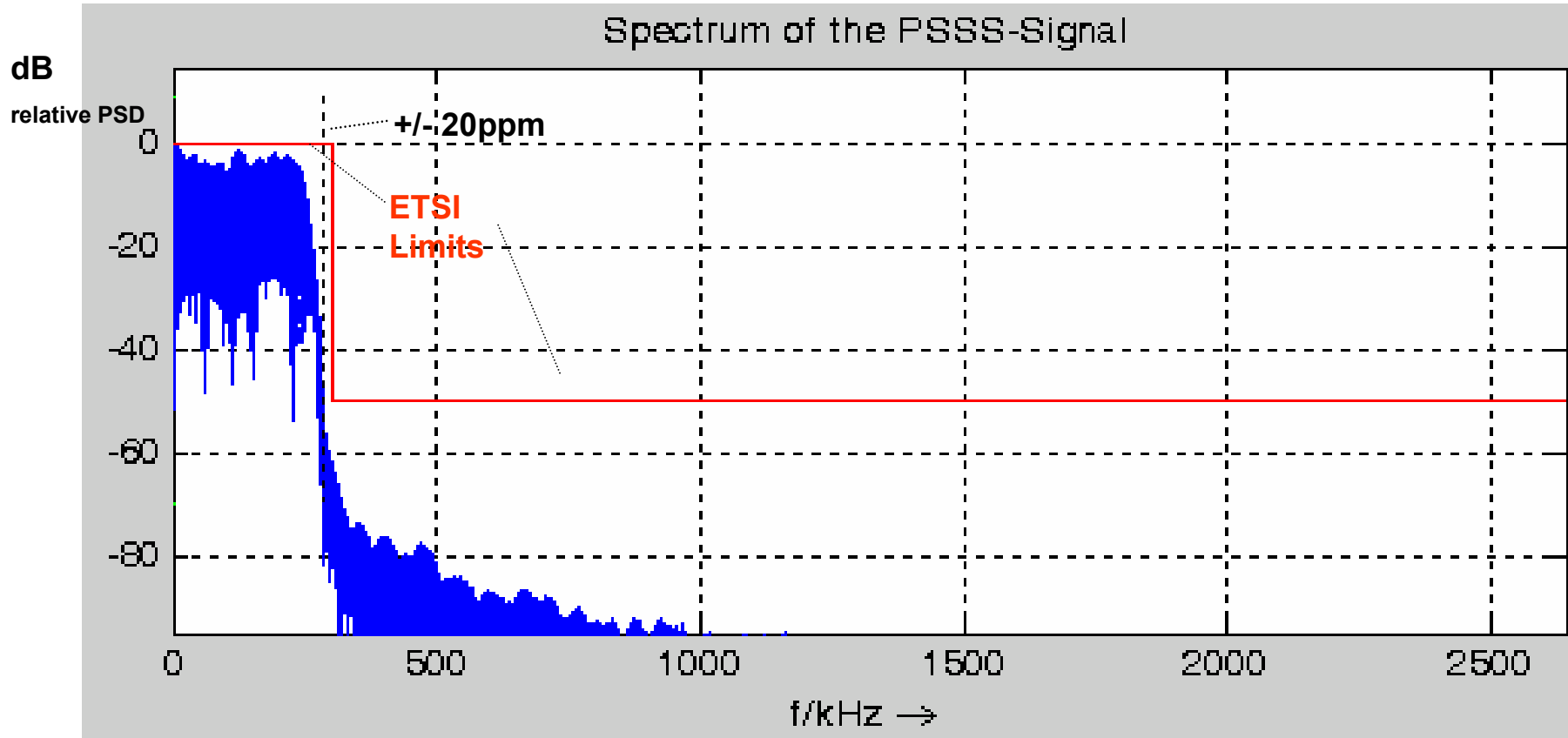

Simulations of the relative PSD in dB for the PSSS signal at 480 kchips/s, 225 kbit/s, +/- 20ppm.
Conditions: linear, precoding

PSD PSSS Signal

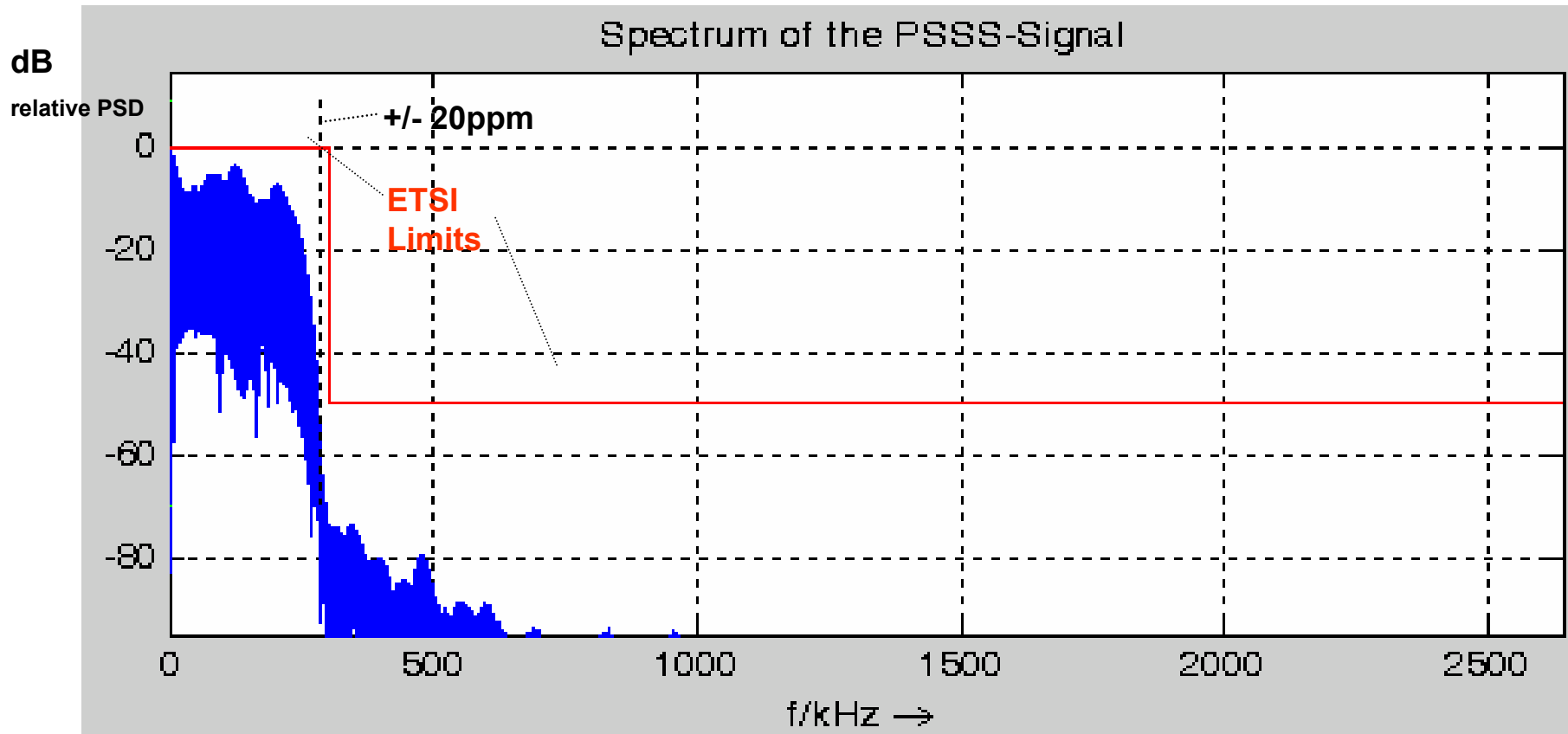

Simulations of the relative PSD in dB for the PSSS signal at 480 kchips/s, 225 kbit/s, ± 20 ppm.
Conditions: non linear, no precoding

PSD PSSS Signal

Spectrum of the PSSS-Signal

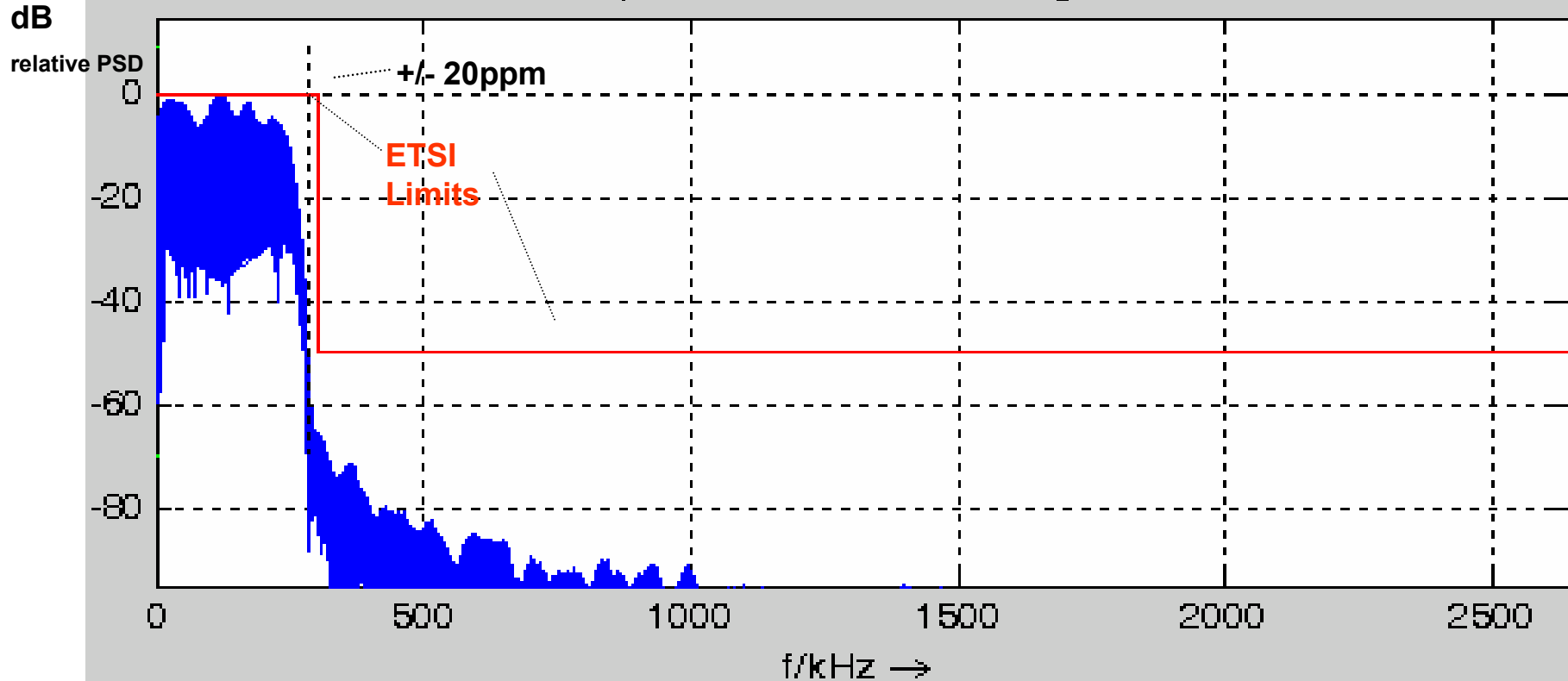

Simulations of the relative PSD in dB for the PSSS signal at 480 kchips/s, 225 kbit/s, +/- 20ppm.
Conditions: non linear, precoding

Simulation Model 2

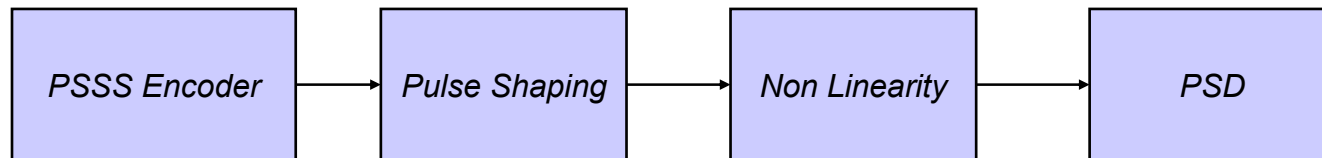

Non Linear Transfer Function

Used transfer function for simulating PSD for non linearity

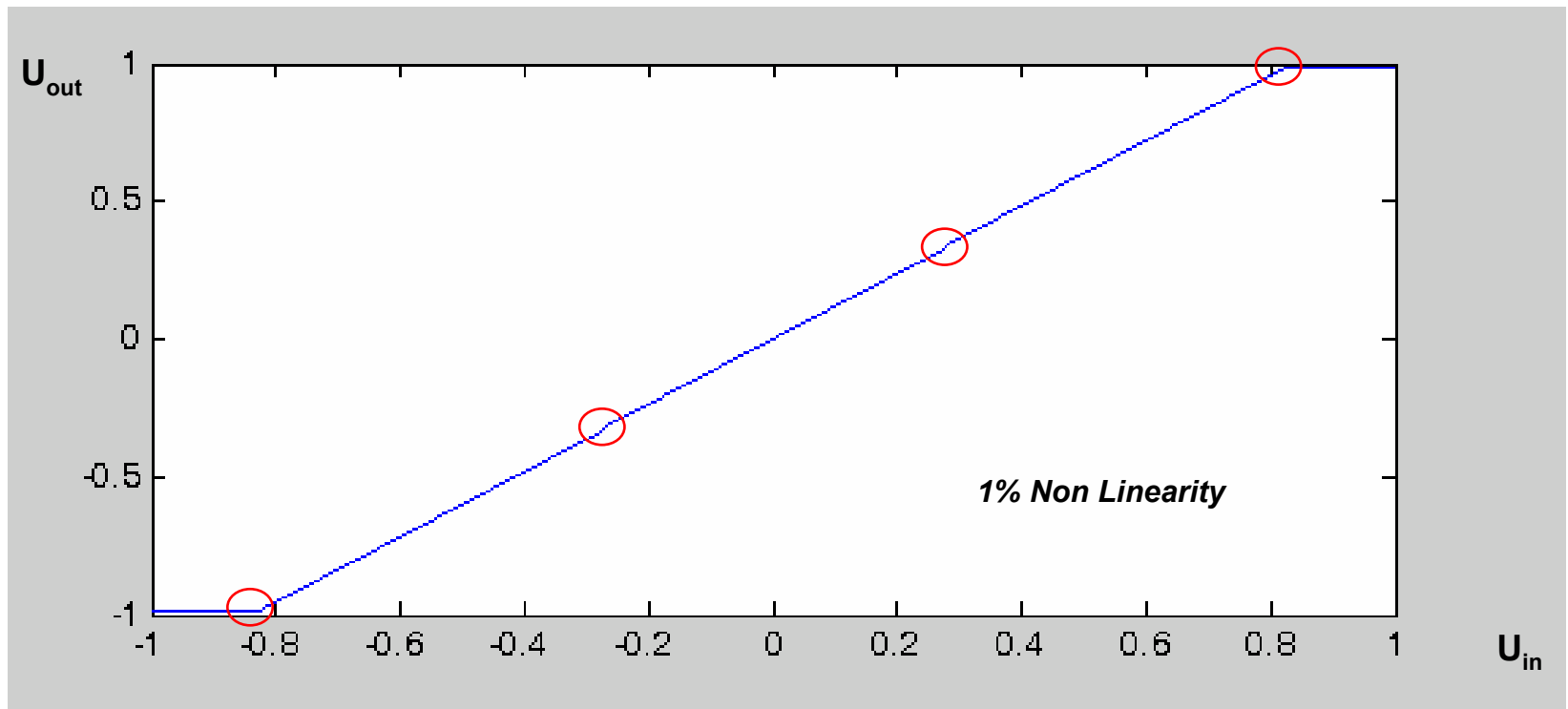

PSD PSSS Signal

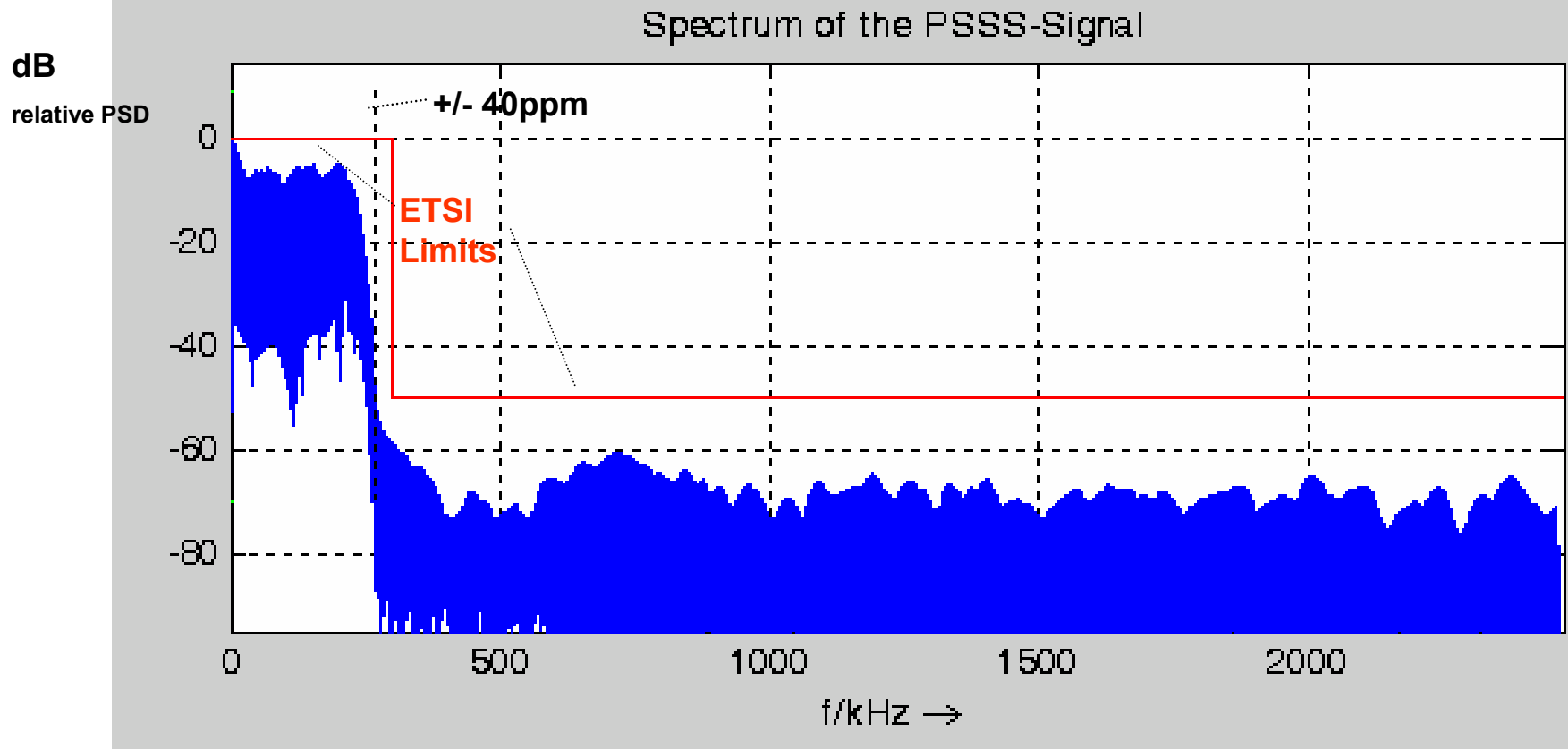

Simulations of the relative PSD in dB for the PSSS signal at 450 kchip/s 210 kbit/s.
Conditions: nonlinear, precoding, +/-40 ppm

PSD PSSS Signal

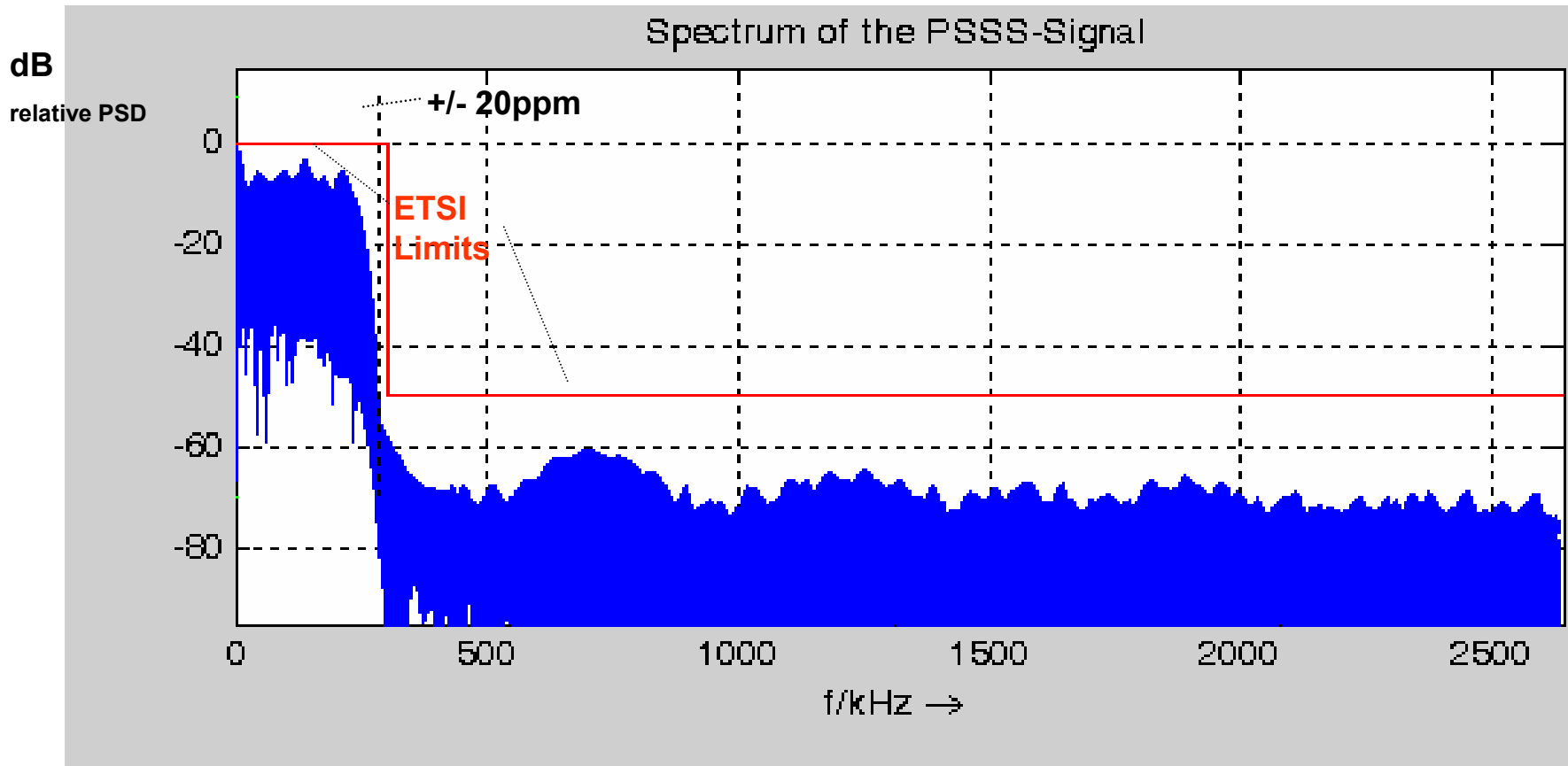

Simulations of the relative PSD in dB for the PSSS signal at 480 kchip/s 225 kbit/s.
Conditions: nonlinear, precoding, +/-20 ppm

Linearity - Conclusions

- **General Linearity Conclusions**
 - PSSS works even with 20% non linear PA and LNA
 - PA and LNA designs are available off-the-shelf with
 - No increase in chip cost even for linearity of 2%
 - No additional power consumption compared to C class PA used in IEEE802.15.4-2003 today
 - No impact of linearity requirements on power consumption
 - Reviewed and confirmed with two large semiconductor manufacturers
 - No implementation risk due to increased linearity required for PSSS !



Non-linearity simulations are confirmed with PSSS prototype

- **PSD Conclusions**
 - PSSS matches with 500 kchip/s the ETSI recommendations.
 - Depending on pulse shaping passband/baseband Non-Linearity 20%/1% has nearly no effect to PSD.

Note:

Raised cosine pulse shaping in IEEE802.15.4-2003 2.4 GHz in baseband requires higher linearity than binary signal – Class-C PA insufficient

Chip size and power consumption

Chip size

- High tolerance towards non-linearity and simplicity of PSSS minimizes increase in analog part
 - Estimate 0.25 mm² max.
- Digital part: No increase expected due to reduced complexity.
- **Total increase:** 7-10 % PHY max.
4-6 % TRx die
2-3 % SoC die
< 2% SoC cost !
- Increase in size also for Halfrate for required dual radio core
- PSSS proposal option with BPSK/ASK would even reduce chip sizes

Power consumption

- High tolerance against non-linearity and simplicity of PSSS minimizes increase in power consumption
 - Estimate Rx/Tx: 5-10% max.
Sleep: <0.05 μ A
- 15.4 2.4 Ghz chips today spread between 15...55 mA Rx
 - Effect of implementation + process is large vs. increase from PSSS (if any)
- **No visible change in battery lifetime**
 - Most energy for sleep+discharge
 - Longer battery life vs. current 868/915
- Increase expected also for Halfrate due to required dual radio core
- PSSS proposal option with BPSK/ASK has even lower power needs

Assumption: 0.18 μ CMOS process

Presentation Contents

- Introduction
 - Changes vs. PSSS presentation at March 2003 meeting (Orlando)
 - Motivation and requirements for TG4b PHY
 - New Specifications for Low Bands
- PHY Performance
- PHY Technology
 - O-QPSK / I/Q and BPSK/ASK
- PHY Implementation aspects
 - Selected Rx implementation options
 - Crystal quality – frequency offset tolerance
 - Linearity
 - Chip size and power consumption
-  Status
 - PAR compliance
 - Summary

Status

- Comprehensive research and development on PSSS has been performed based on:
 - **Full simulation**
 - **Configurable prototype for PSSS**
 - **Analytical model for PSSS**

 Minimal risk for implementation due to well understood technology and all building blocks being widely available

PAR compliance

- PSSS as proposed is *derivative* of current 2.4 GHz PHY – *fulfills PAR*
 - 32-chip base codes, shifted to derive multiple codes
 - 32 complex chips per symbol in airlink
 - 8x parallel use of 2.4 GHz PHY coding scheme
 - Use of O-QPSK / I/Q modulation
- Confirmed by TG4b task group in May 2004 meeting – Discussion / review found unanimously that “**nothing that is presented here is against the PAR**” (minutes in IEEE 15-04-0272-00-004b)
 - Basis for this statement was a comparison presented and discussed based on the March presentations of PSSS (IEEE 15-04-121-03-004b) and Halfrate
- BPSK/ASK option proposed is based on OEM / chip requirement
 - Reduction of complexity and cost due to single radio core
- If we interpret “**derivative**” as “**identical at half the clock rate**” we likely miss the market opportunity with TG4b and open for competition
 - Only Halfrate fulfills “**narrow**” interpretation – but cannot be used in Europe
 - We need to fulfill the PAR *and* the requirements to build a successful standard

Summary

- The proposed parallel reuse of the 2.4 GHz 802.15.4 modulation technology in PSSS offers highly attractive performance improvement increasing market opportunities
 - Higher data rate and multiple channels possible in both current *and* upcoming European band and certainly also in 915 MHz band
- Significantly stronger multipath fading robustness in PSSS – up to 2 μ s
 - Visibly higher range in many attractive, high volume target areas
- 7.5x higher spectral efficiency through PSSS compared to the current PHY for 868/915 MHz – 8x higher vs. Halfrate proposal
 - Enables higher data rates for lower power consumption
 - Turns duty cycle limits in Europe into protection against interference
 - More efficient use of spectrum and resulting better coexistence
- Very easy backward compatibility to the 2.4 GHz PHY, also easy adaptation to current 868/915 MHz designs
 - PSSS is derivative superset of current 2,4 GHz PHY technology
 - Automatic fallback to current 15.4 868/915Mhz standard easily possible



Only proposal that fulfills all key OEM requirements