

**Project: IEEE P802.15 Study Group for Wireless Personal Area Networks (WPANs)**

- Submission Title:** PSSS proposal – Parallel reuse of 2.4 GHz PHY for the sub-1-GHz bands
- Date Submitted:** 17 November 2004
- Source:** Andreas Wolf, DWA Wireless GmbH and Hans van Leeuwen, STS-wireless  
**DWA Wireless GmbH**  
Tel.: +49 (0)700 965 32 637 [aw@dw-a.com](mailto:aw@dw-a.com)  
**STS BV, The Netherlands**  
Tel: +31 20 4204200, cell +1 858 344 5120 [hvl@sts.nl](mailto:hvl@sts.nl)
- Re:** Analysis of PSSS for higher data rates for PHY for sub-1-GHz
- Abstract:** The proposed parallel reuse of the 2.4 GHz 802.15.4 modulation technology in PSSS offers highly attractive performance improvement, fulfills all key OEM requirements, and visibly increases market opportunities.
- Purpose:** Further analysis of PSSS as in accepted joint PHY proposal from September 2004
- Notice:** This document has been prepared to assist the IEEE P802.15. It is offered as a basis for discussion and is not binding on the contributing individual(s) or organization(s). The material in this document is subject to change in form and content after further study. The contributor(s) reserve(s) the right to add, amend or withdraw material contained herein.
- Release:** The contributor acknowledges and accepts that this contribution becomes the property of IEEE and may be made publicly available by P802.15.

# PSSS Proposal

## Parallel reuse of 2.4 GHz PHY for the sub-1-GHz bands

Andreas Wolf  
(aw@dw-a.com)  
Dr. Wolf & Associates GmbH

Hans van Leeuwen  
(hvl@sts.nl)  
STS

## Presentation Contents

- Introduction
  - Summary of OEM requirements for the TG4b PHY
- PSSS variants reviewed in this document
- PSSS Performance
  - BPSK / ASK modulation
  - O-QPSK / I/Q modulation
- PSSS Implementation aspects
  - Crystal quality – frequency offset tolerance
  - PSD
  - Chip size and power consumption
- Status
- Summary
  
- Attachments
  - PSSS PHY Tx operation
  - Selected Rx implementation options
  - Linearity

## Key requirements for sub-1-GHz band PHY

- **Bitrate over 200 kBit/s**
  - Number of permitted transactions/hr is insufficient in IEEE802.15.4-2003 868 Mhz
    - 1% duty cycle at 20 kbit/s translates into typically only 600-800 transactions/hr
    - With > 200 kbit/s sufficient number of transactions/hr for our targeted applications
    - Disadvantage of 1% duty cycle limit turns into *protection against interference*
  - Extension from 20/40 kbit/s extends total battery lifetime by 15-40%
- **Visibly improved multipath fading robustness over IEEE802.15.4-2003 2.4 GHz**
  - Improve coverage in “challenging” RF environments – Especially commercial, industrial
  - Achieve PER <  $10^{-3}$  at channels with at least 1  $\mu$ s delay spread (non-exponential channel models)
- **Support of current RF regulatory regimes *plus* enable the use of extended bands**
  - Support 2 MHz wide channels in the USA and other countries where they are permitted
  - Support of current 600 kHz band available at 1% duty cycle in Europe today
  - Allow use of extended European bands and bands in other countries once they become available
    - Allow addition of additional 600 kHz channels as per current ETSI / ECC report (4/6 channels?)
    - Do not expect US-like wide, unrestricted bands or all regulatory domains
  - Support of more flexible channel selection method to flexibly add support for more countries
- **Backward compatibility to IEEE802.15.4-2003 (915/868 MHz)**
  - Interoperability when switched to 15.4-2003 mode
  - No fully transparent backward compatibility as in 802.11b vs. 802.11 or 802.11g vs. 802.11b
- **Low cost and low power consumption (!)**

## PSSS variants reviewed in this presentation

	<b>PSSS 234-600</b>	<b>PSSS 225-600</b>	<b>PSSS 210-600</b>	<b>PSSS 250-600 a/b</b>	<b>PSSS 250-2000</b>
Bandwidth	600 kHz	600 kHz	600 kHz	600 kHz	2,000 kHz
Chiprate	500 cps	480 cps	450 cps	266.6 / 400 cps	800 kcps
Bitrate	234 kit/s	225 kbit/s	210 kbit/s	250 kbit/s	250 kbit/s
Spectral efficiency	15/32 bit/s/Hz	15/32 bit/s/Hz	15/32 bit/s/Hz	0.9375 / 0.625 bit/s/Hz (30/32; 20/32)	0.3125 bit/s/Hz (10/32)
Spreading	15x 32-chip seq.	15x 32-chip seq.	15x 32-chip seq.	10x 32/15x32-complex chip seq.	5 x 32 complex chip seq.
RF backward compatibility	Single BPSK / ASK radio	Single BPSK / ASK radio	Single BPSK / ASK radio	IQ radio	IQ radio
<i>Comments</i>	Original mode in joint proposal	Added upon TG4b request to have "more even" bitrate	Added upon chip manufacturer input to reduce complexity / costs	Added as variant based on I/Q modulator + low cost 250 kbit/s in 600 KHz	Added as variant to show that use of PSSS is also attractive in 2 MHz channels

 **Choice to be discussed in TG4b**

Note:

DWA fully supports the accepted joint proposal - variants are provided to provide a more comprehensive analysis

# Challenges in comparison of PHY variants in TG4b PHY subcommittee

- Uneven level of analysis and scrutiny between PSSS and COBI
  - Despite major deviation from IEEE802.15.4-2003 2.4 Ghz design, many implementation challenges are not yet reviewed for COBI, e.g. synchronization, PSD, required linearity, Rake receiver
- Current COBI simulations discussed are not suitable to drive conclusions
  - Limited, incomplete simulation model – e.g. without preamble, synchronization
  - Critical parts of Rake receiver are not simulated (furthermore, experience is that even full Rake simulations deviate significantly from actual implementations – commonly accepted in scientific literature)
  - Switch from agreed comparison of PER to BER (focus on irrelevant BER values)
  - COBI8 variants shown *cannot* fulfill ETSI spectrum mask (Nyquist)
- Unclear PSSS simulations from IIR
  - Results from September 2004 and now are inconsistent
  - PSSS without precoding is shown with lower performance than with precoding
  - PSSS is shown with unnecessary Rake receivers driving irrelevant and misleading conclusions

# Simulation models used

## Simulation model used by DWA

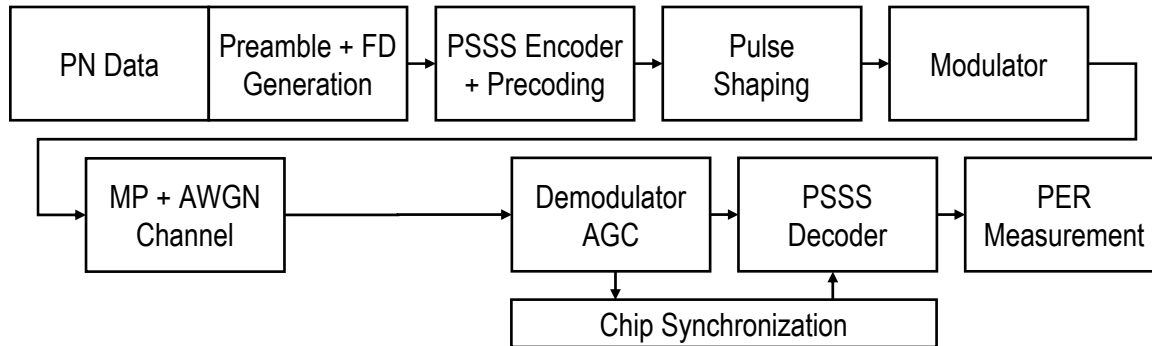

## Simulation model used by IIR in TG4b PHY discussions

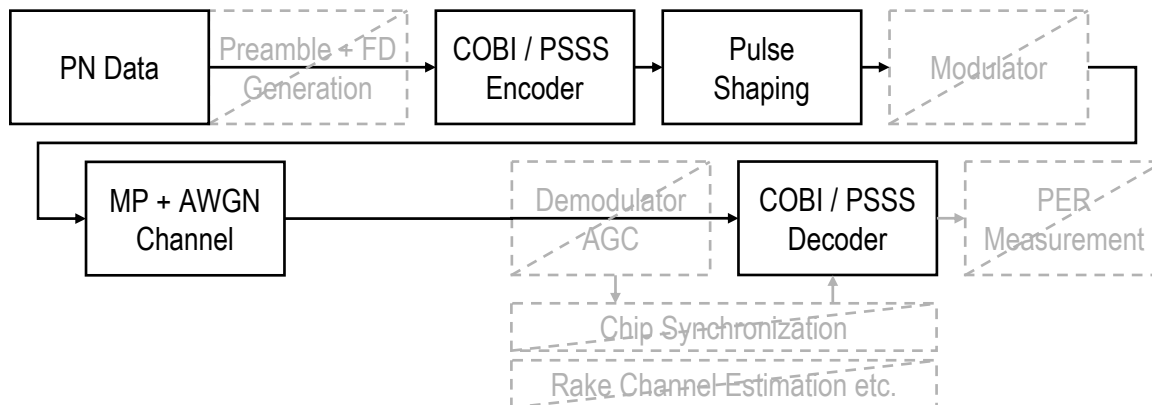

- Agreed simulation model used by DWA:

### Discrete exponential model

- Sampled version of diffuse model (high sampling rate)
- At least 1000 random channel realizations
- **PER** calculated on complete PPDU with preamble and FD

- Notes:

- Results shown by IIR for COBI8 are based on model with PSD that violates ETSI
- **BER** of only  $10^{-3}$  /  $10^{-4}$  shown is insufficient for target market – **PER** of  $10^{-3}$  is typically used in IEEE802
- COBI Rake receiver structure unclear
- Preamble proposed by IIR for COBI16/8 is inappropriate for use with rake (i.e. too short for accurate channel estimation)
- Is preamble proposed sufficient for other COBI modes?
- **Rake receiver requires higher accuracy for AGC and linearity. Effects have to be investigated.**

# Earlier results of basic model also used by IIR

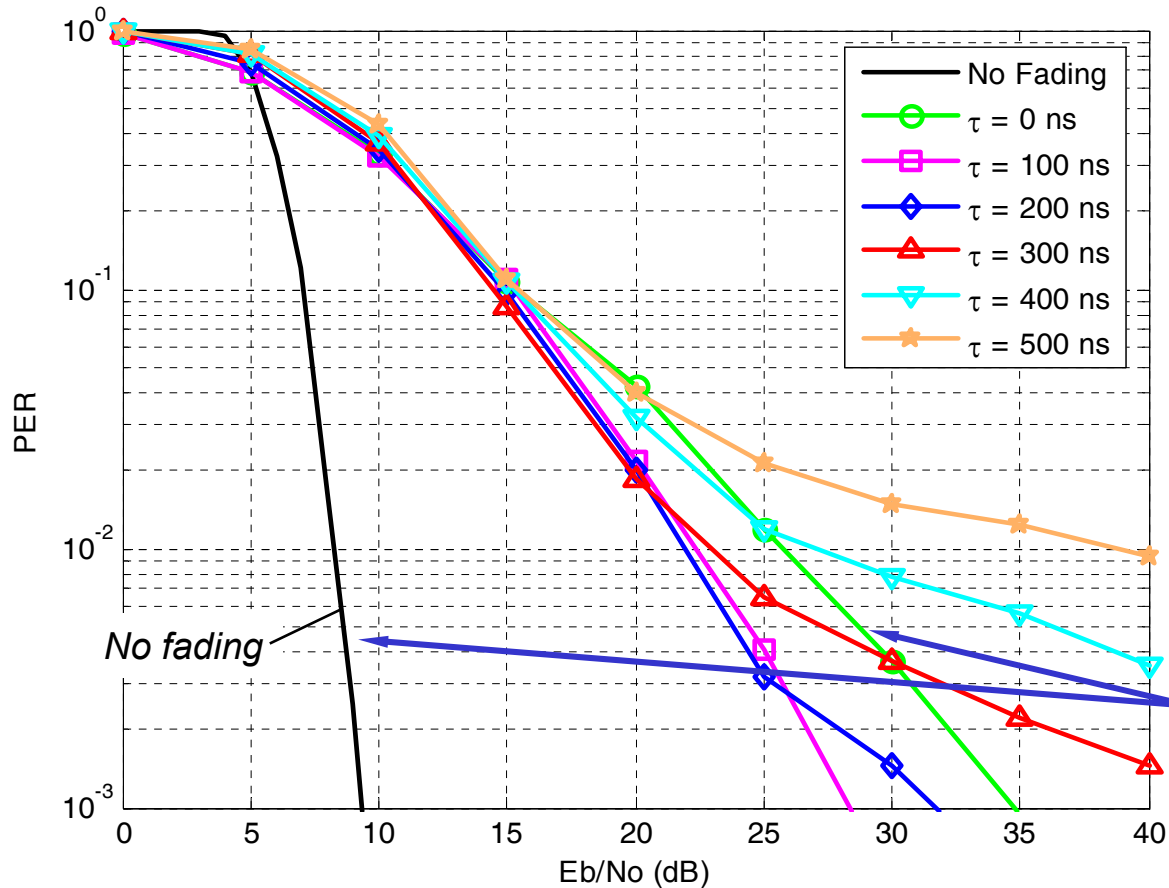

*Channel with 0ns RMS delay spread differs from "no fading" due to channel model characteristic*



# Channel Reponse – Simulation of 1429 Frames used by DWA

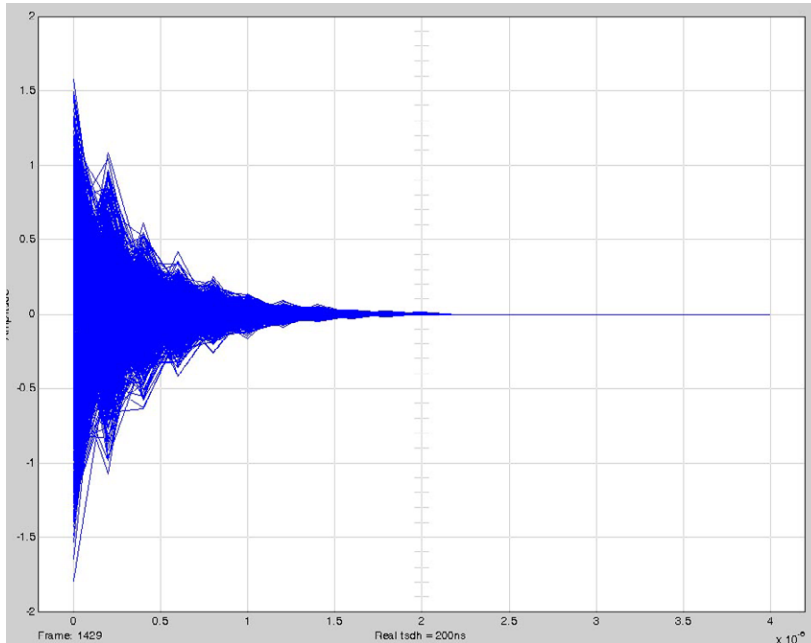

**Real Part**

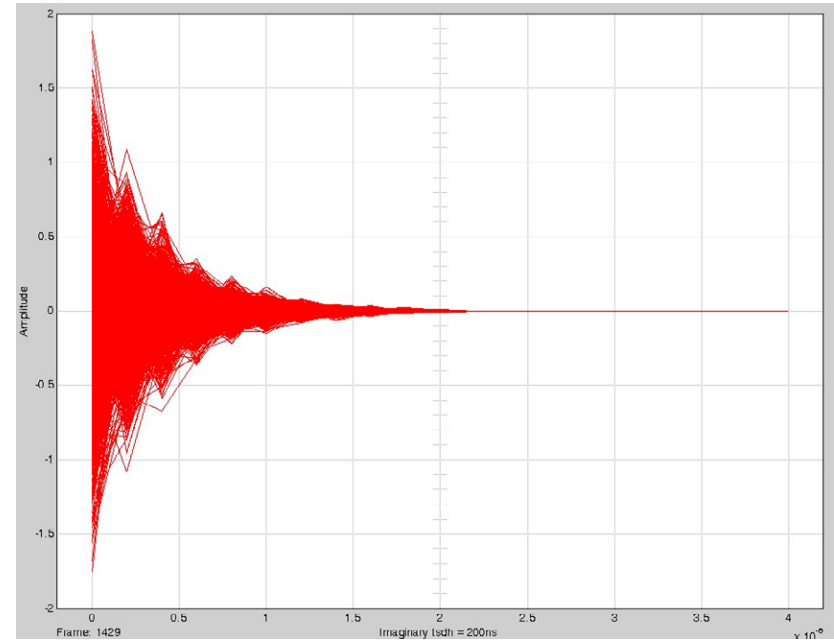

**Imaginary Part**

**Note:**

*Actual channels in industrial and commercial environments are having significantly higher probability for non-exponential amplitude/time than assumed in the agreed and used model*

# PSSS – BPSK/ASK variant<sup>1</sup> (15/32 bit/s/Hz) simulated

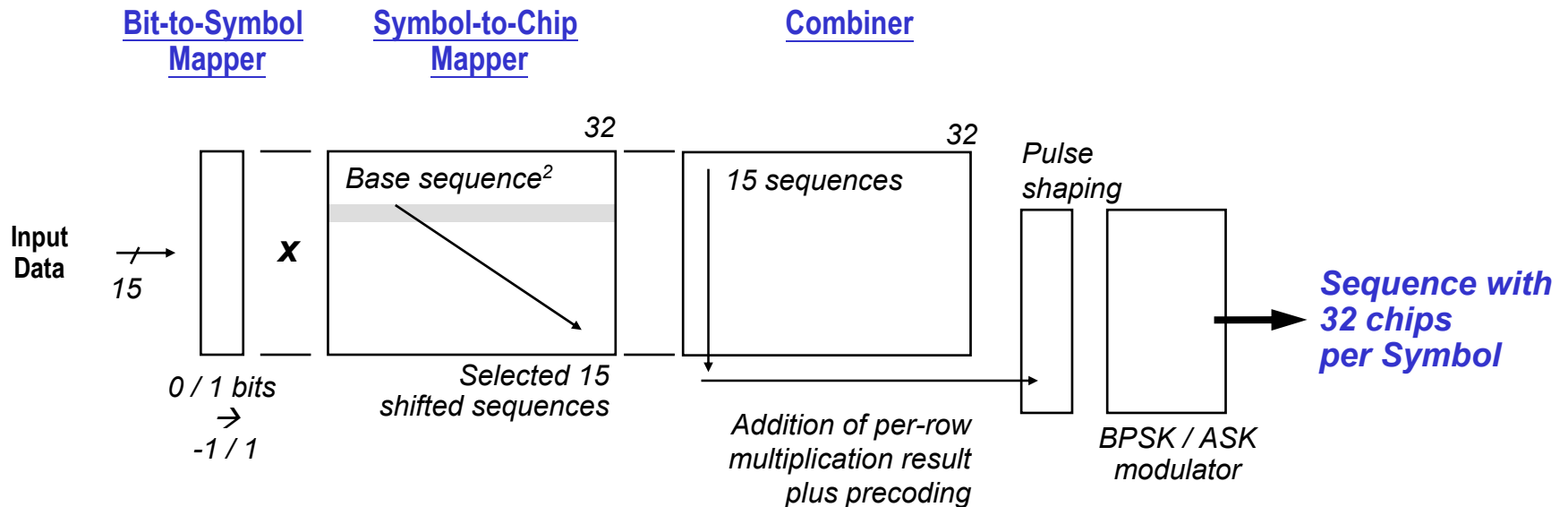

*...addition of multiple parallel sequences instead of selection of single sequence*

1: PSSS 225-600 + PSSS 210-600

2: Use of single base sequence simplifies implementation in Rx

## PER Performance PSSS BPSK/ASK variant – Discrete Exponential Channel, 370ns RMS Delay Spread

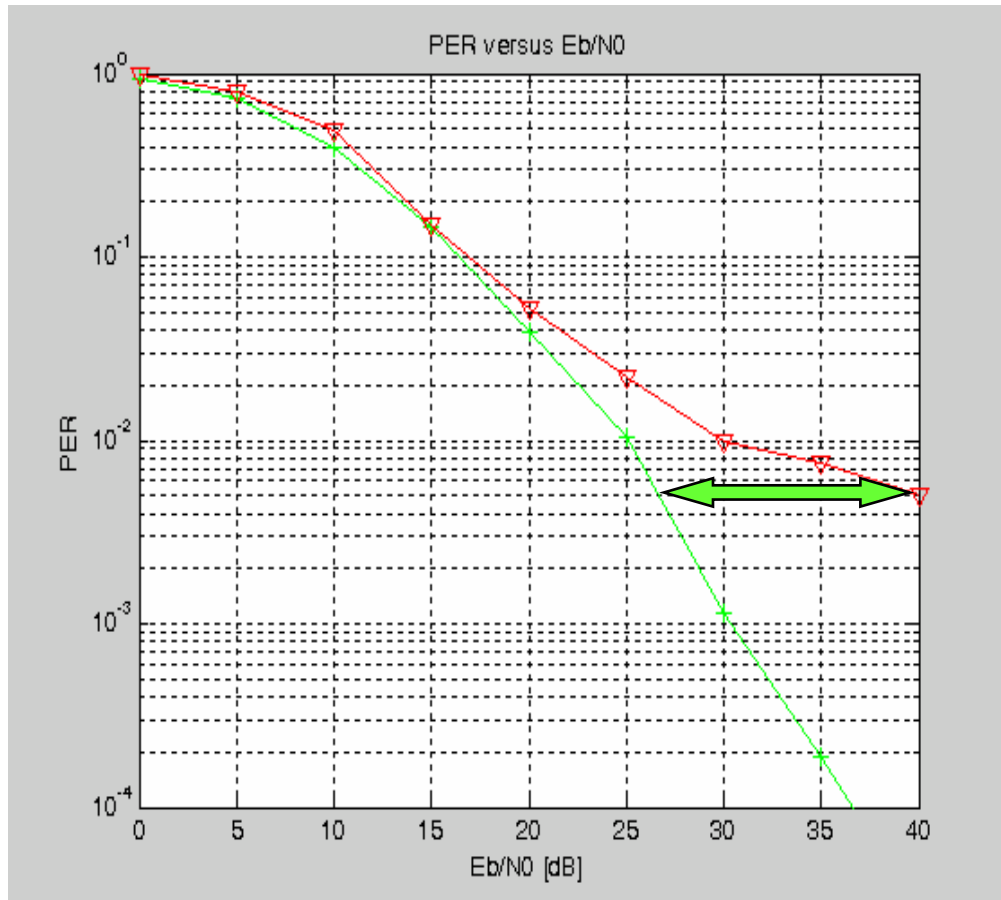

- Over 12 dB performance benefit in relevant PER range
  - Even higher benefit in environments with higher MP fading challenges
- COBI8 performance is estimated to be 4...7dB weaker than even COBI16
  - Little if any performance benefit over 868MHz FSK chips

***PSSS fulfills performance requirements without adding complexity, cost, and power consumption for rake receivers***

– PSSS 225 kbit/s    – COBI16+1 235 kbit/s    > 10000 Channel, no Rake receivers

# PSSS – 250 kbit/s I/Q variant 1 (IQ1) simulated<sup>1</sup>

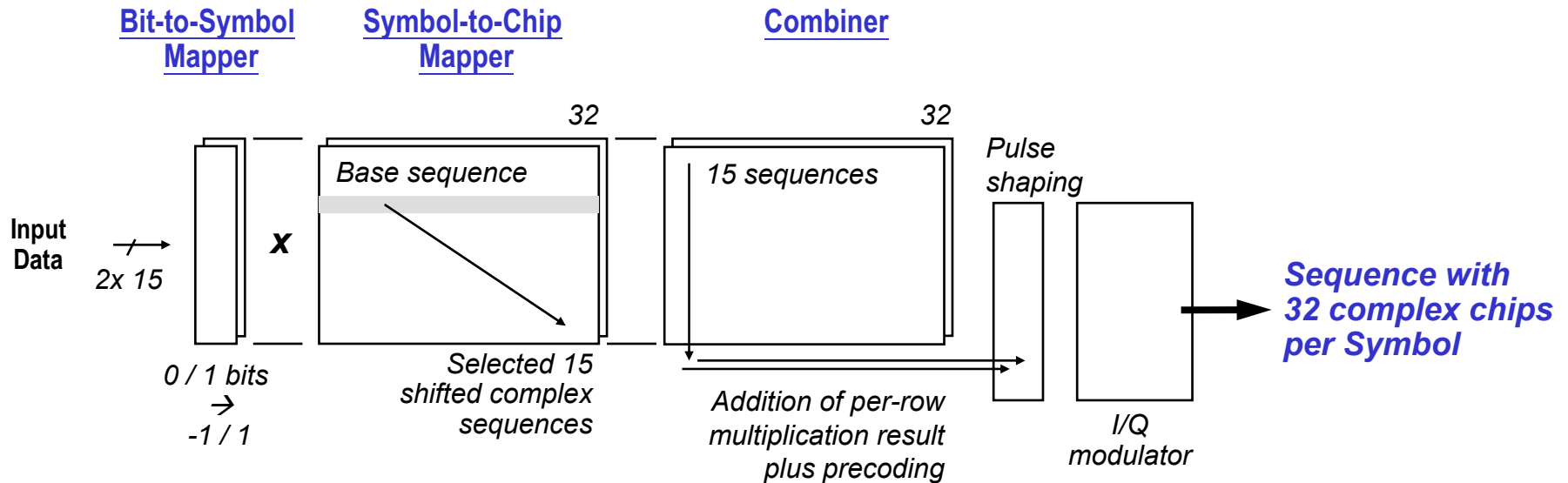

*... simplest pulse shaping enabling very low cost implementation*

1: PSSS 250-600a

# PSSS – 250 kbit/s I/Q variant 2 (IQ2) simulated<sup>1</sup>

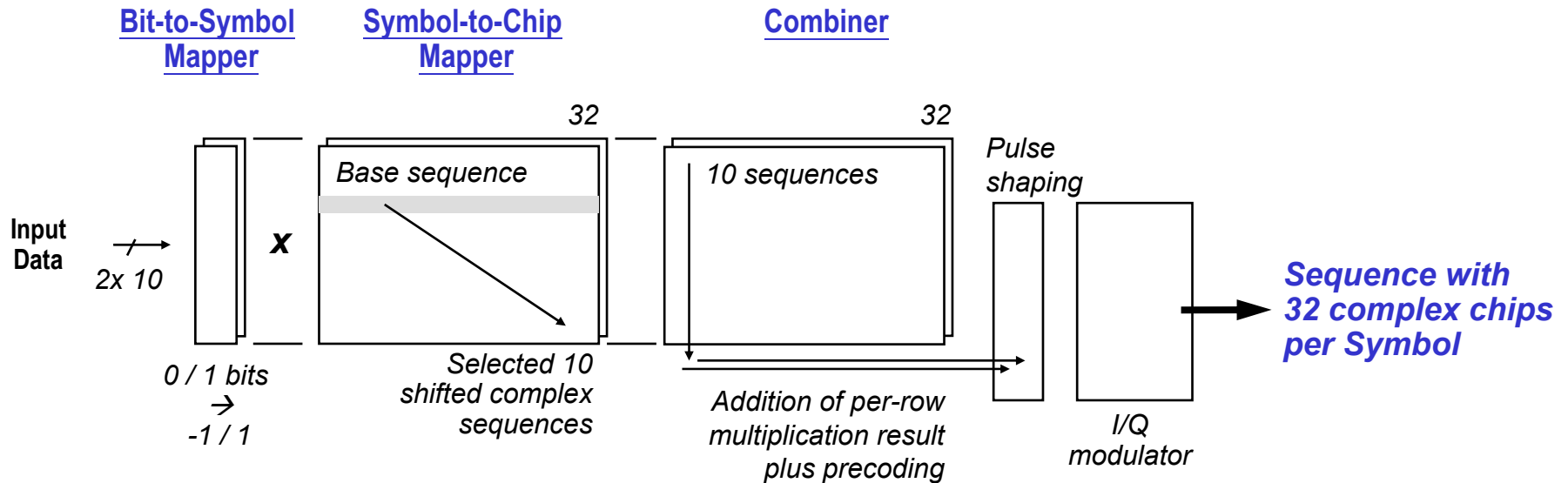

*... enables reuse of chip designs  
with I/Q modulator / demodulator*

<sup>1</sup>: PSSS 250-600b

## PER Performance PSSS IQ variants – Discrete Exponential Channel, 370ns RMS Delay Spread

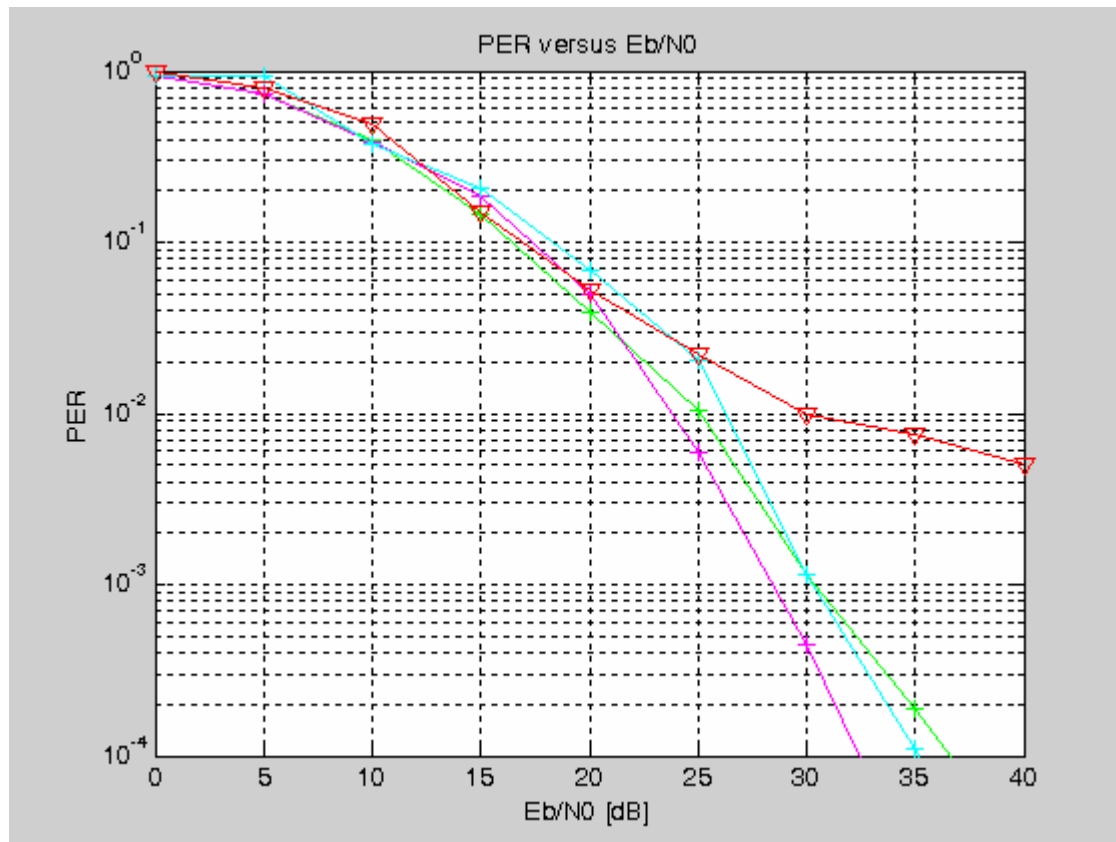

Similar and even higher benefit  
over COBI16

- PSSS 225 kbit/s
- COBI16+1 coherent, 235 kbit/s
- PSSS IQ1 (250-600a)
- PSSS IQ2 (250-600b)

## Presentation Contents

- Introduction
  - Summary of OEM requirements for the TG4b PHY
- PSSS variants reviewed in this document
- PSSS Performance
  - BPSK / ASK modulation
  - O-QPSK / I/Q modulation
- PSSS Implementation aspects
  - Crystal quality – frequency offset tolerance
  - PSD
  - Chip size and power consumption
-  Status
  - Summary
- Attachments
  - PSSS PHY Tx operation
  - Selected Rx implementation options
  - Linearity

## Crystal quality – Tolerated frequency offset

- Performance against frequency offset –  
*Original target in TG4: Up to  $\pm 40\text{ppm}$* 
  - Assumptions for chip clock:
    - PDU length 127 Byte =  $8 \cdot 127$  bit = 1016 bit
    - 15 bit per PSSS Symbol (32 chip)
    - $\rightarrow$  68 PSSS Symbols with 2176 chips (Chip duration  $T_c = 2\mu\text{s}$ )
  - Results
    - 40ppm for 2176 chips = 0.087 chip error for the whole PDU
    - For one PSSS Symbol with 32 chips  
the error is about  $40\text{ppm} \cdot 32$  chip = 0,00128 chip

 **No influence to PSSS Performance by  $\pm 40\text{ppm}$  and worse crystal**



# Crystal quality – Tolerated frequency offset – Measurements from PSSS prototype

## 0.1% Chip Clock Error

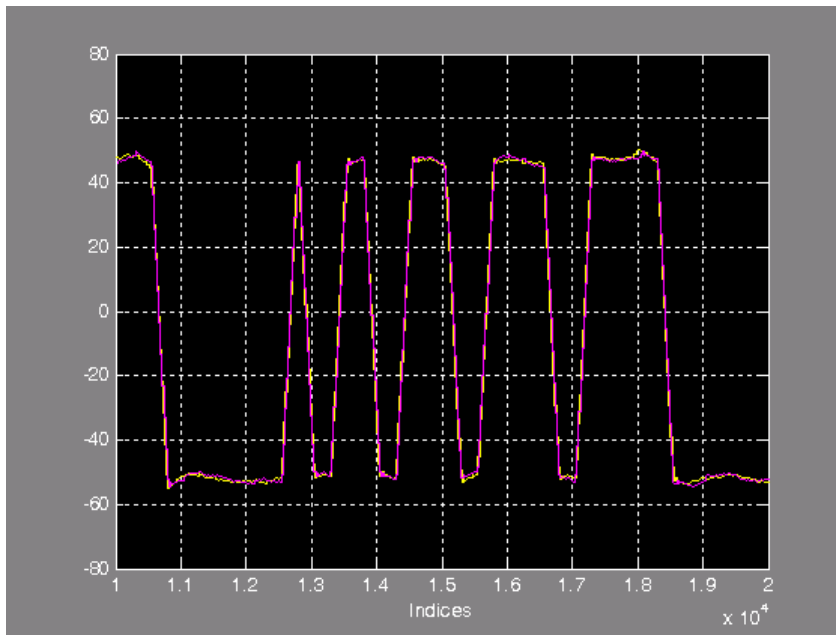

## 1% Chip Clock Error

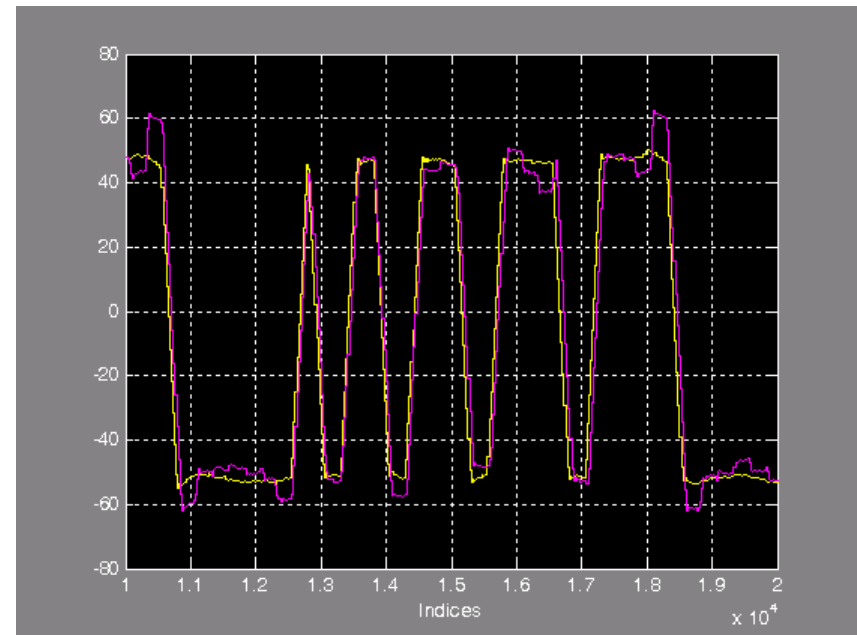

**Yellow:** 0% chip clock error reference signal  
**Pink:** 0.1% and 1% chip clock error



**Calculation of crystal quality tolerance confirmed with prototype**

# Simulation models used for pulse shaping

## Passband pulse shaping model

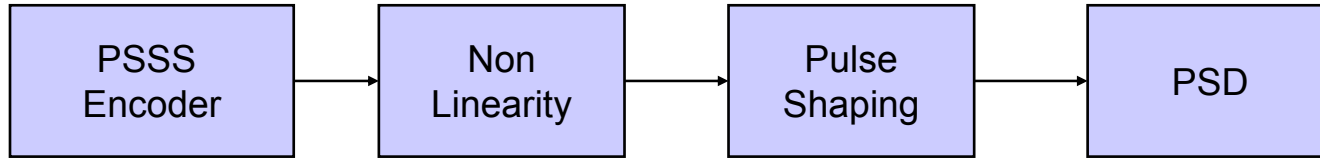

## Baseband pulse shaping model

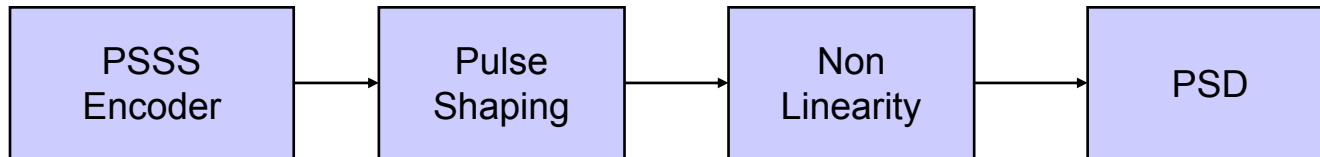

### Notes:

- Pulse shaping per draft specification text provided submitted by DWA
- Details of models conformant to ETSI recommendations
- Actual bandwidth for PSD 16 kHz simulation
- Square root raised cosine filter  $r=0.1$ 
  - Theoretical limit  $r=0.2$
- ETSI power limits are absolute +14 dBm inband, -36 dBm outband
  - For simulation assumed to send with max. power +14 dBm
  - Therefore simulation results contain relative PSD levels
    - +14 dBm -> 0 dB
    - -36 dBm -> -50 dB

# Non Linear Transfer Function – Passband pulse shaping

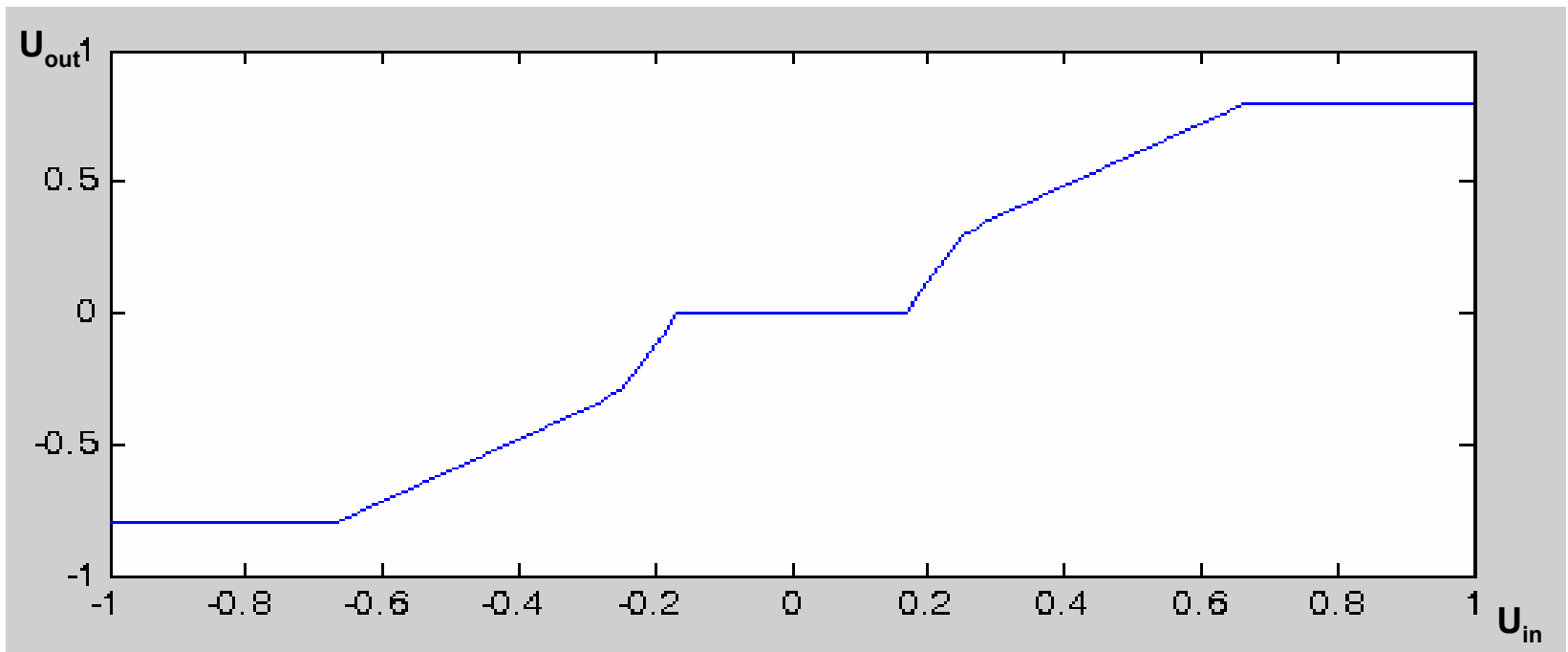

Used transfer function for simulating PSD for non linearity

# Non Linear Transfer Function – Baseband pulse shaping

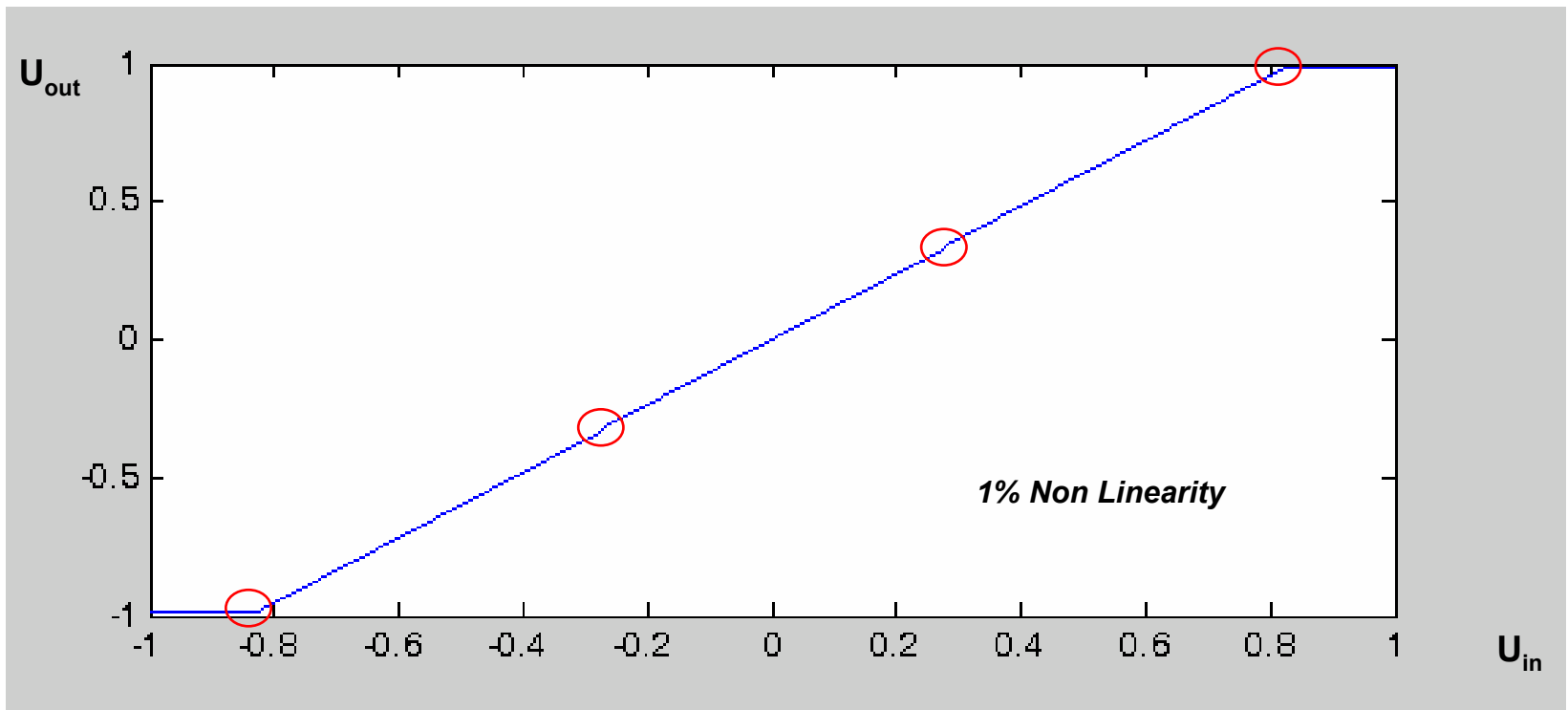

Used transfer function for simulating PSD for non linearity

# PSD PSSS Signal – Passband pulse shaping, linear, no precoding

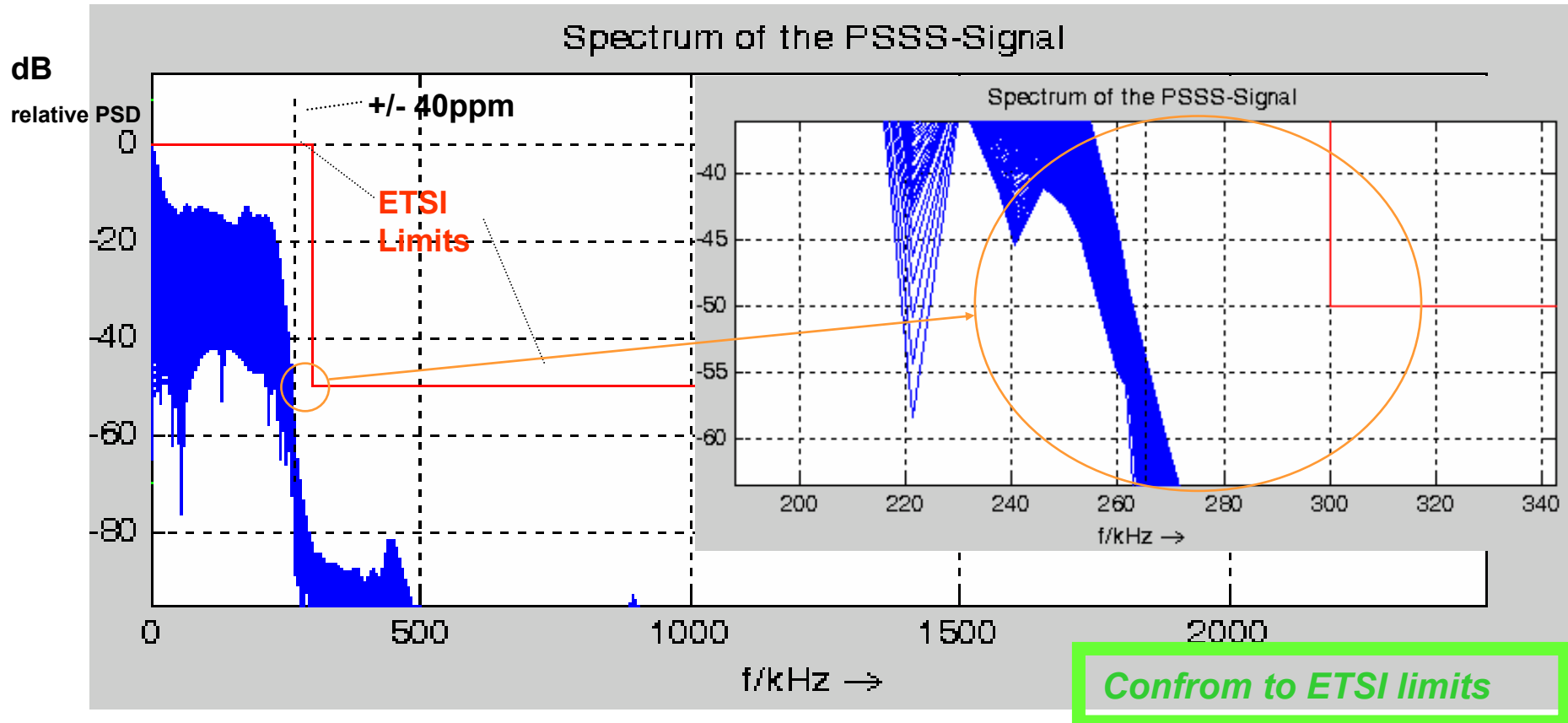

Simulations of the relative PSD in dB for the PSSS signal at 450 kchips/s, 210 kbit/s, +/- 40ppm.

# PSD PSSS Signal – Passband pulse shaping, linear, precoding

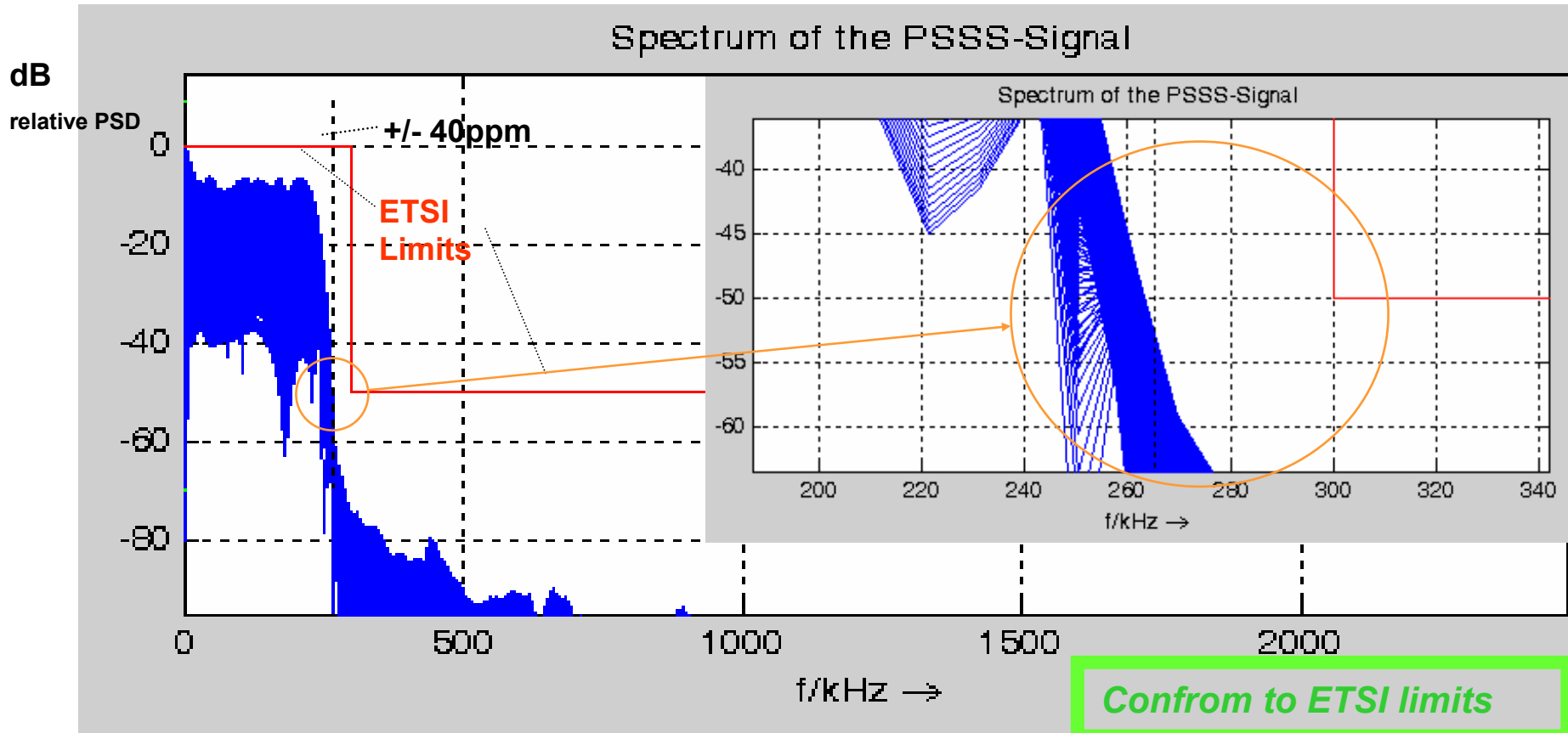

Simulations of the relative PSD in dB for the PSSS signal at 450 kchips/s, 210 kbit/s, +/- 40ppm.

# PSD PSSS Signal – Passband pulse shaping, non linear, no precoding

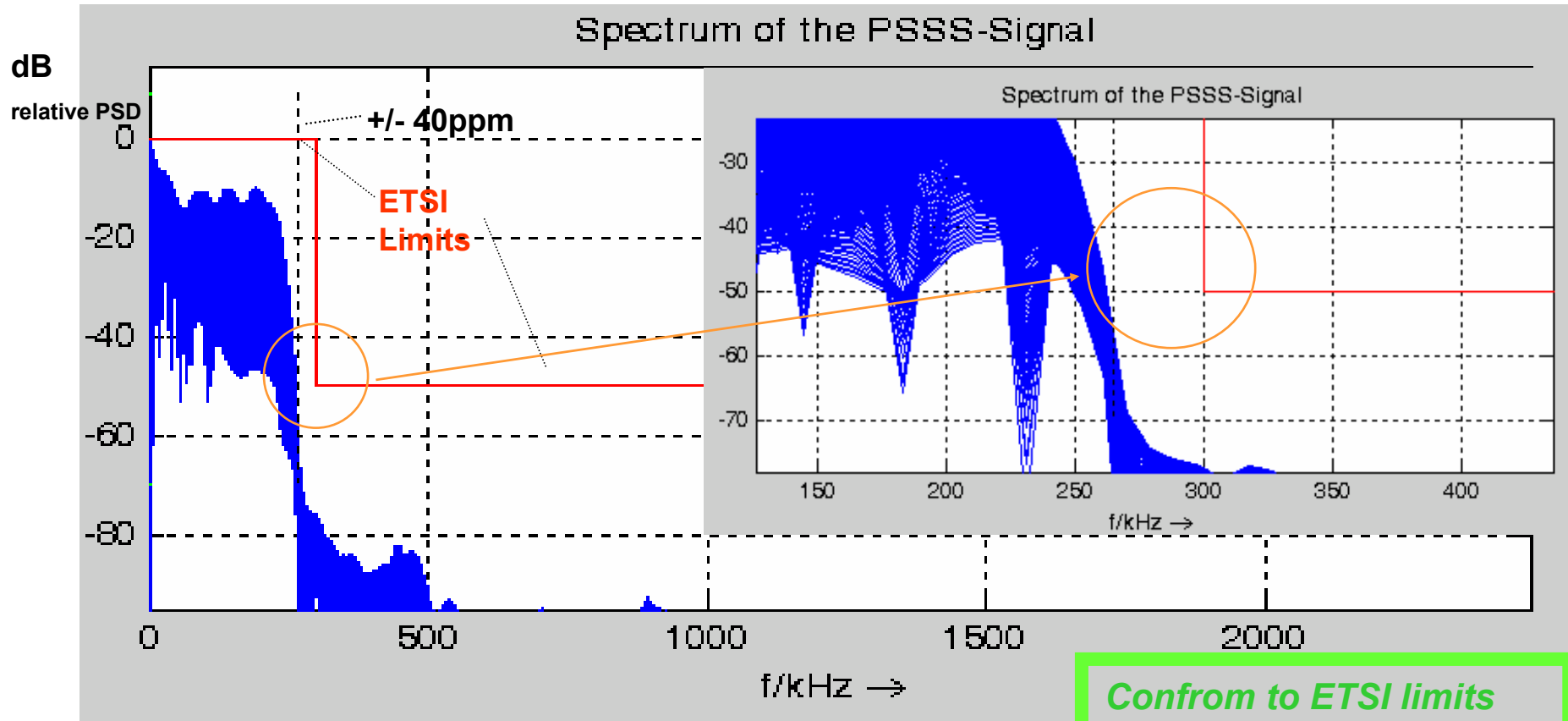

Simulations of the relative PSD in dB for the PSSS signal at 450 kchips/s, 210 kbit/s, +/- 40ppm.

# PSD PSSS Signal – Passband pulse shaping, non linear, precoding

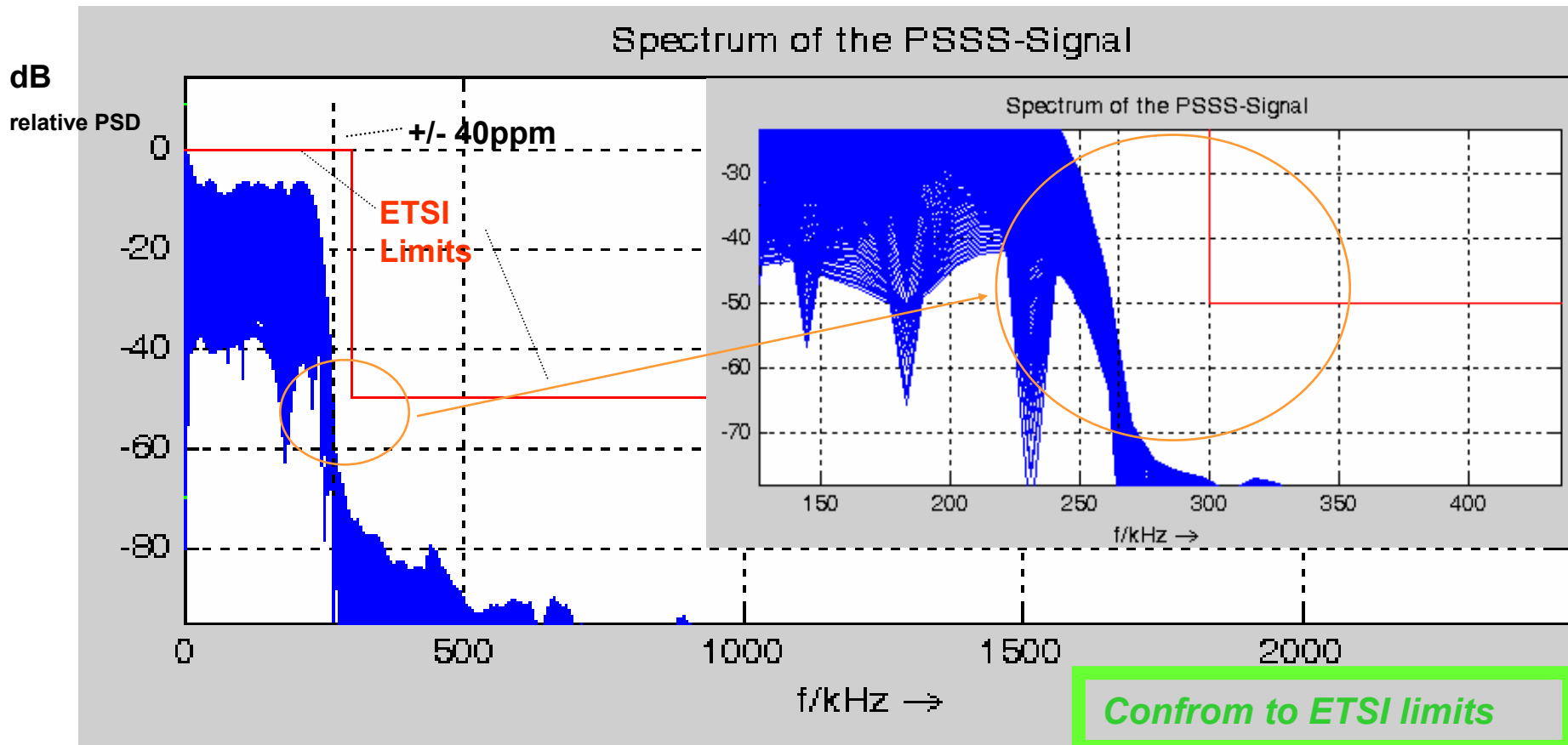

Simulations of the relative PSD in dB for the PSSS signal at 450 kchips/s, 210 kbit/s,  $\pm 40$ ppm.



# PSD PSSS Signal – Passband pulse shaping, linear, no precoding

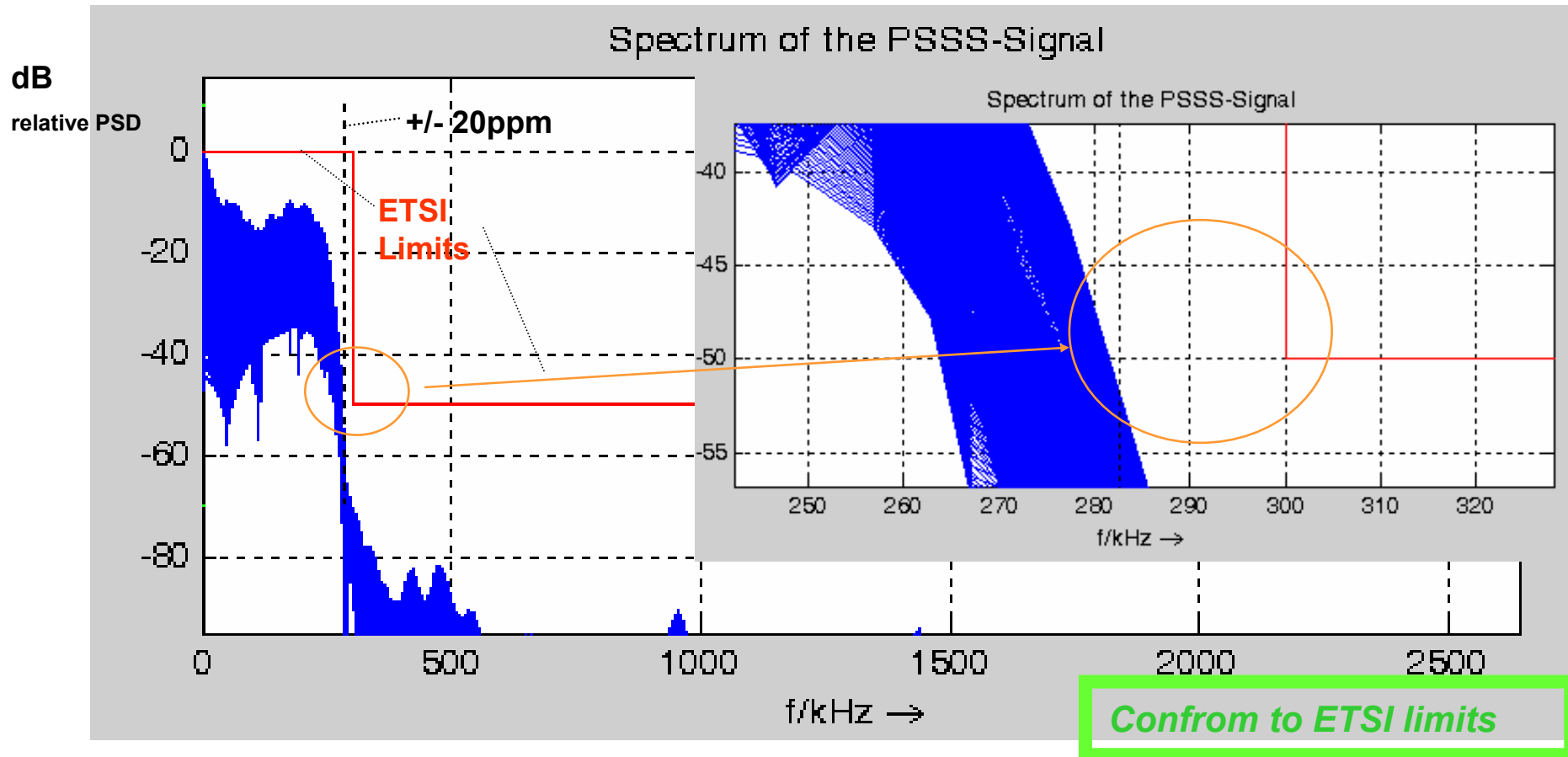

Simulations of the relative PSD in dB for the PSSS signal at 480 kchips/s, 225 kbit/s, +/- 20ppm.  
Conditions: linear, no precoding

# PSD PSSS Signal – Passband pulse shaping, linear, precoding

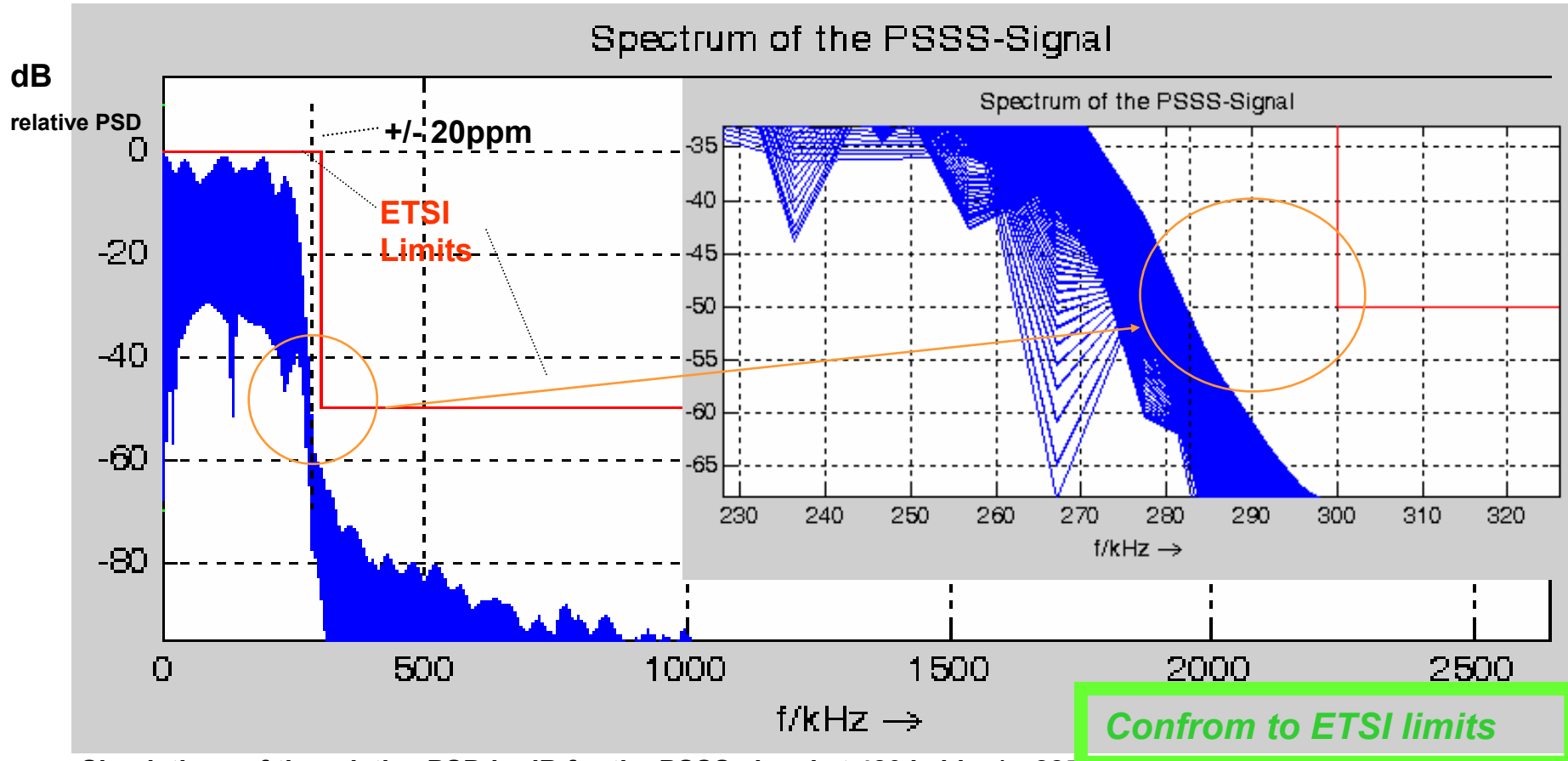

Simulations of the relative PSD in dB for the PSSS signal at 480 kchips/s, 225 kbps,  $\pm 20$ ppm.  
Conditions: linear, precoding

# PSD PSSS Signal – Passband pulse shaping, non linear, no precoding

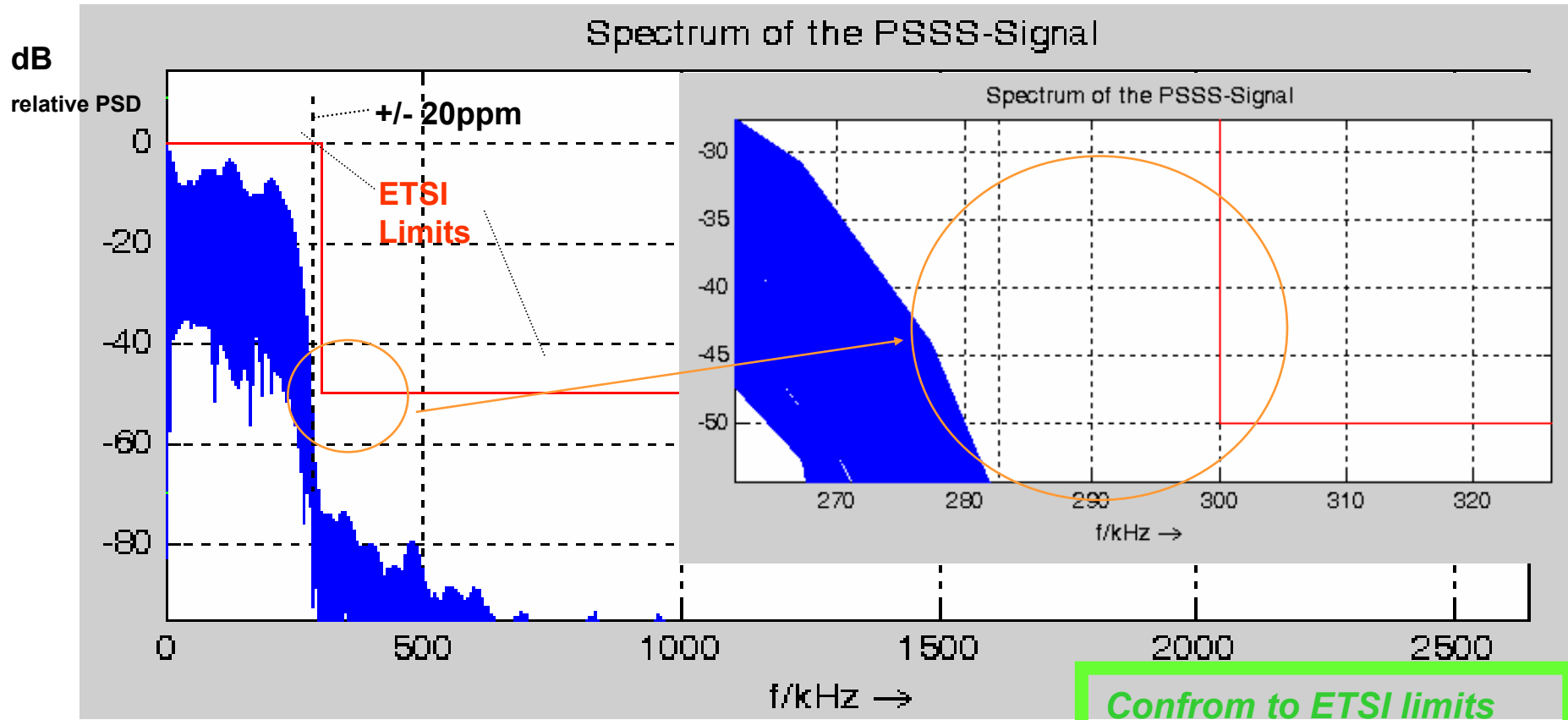

Simulations of the relative PSD in dB for the PSSS signal at 480 kchips/s, 225 kbit/s, +/- 20ppm.  
Conditions: non linear, no precoding

# PSD PSSS Signal – Passband pulse shaping, non linear, precoding

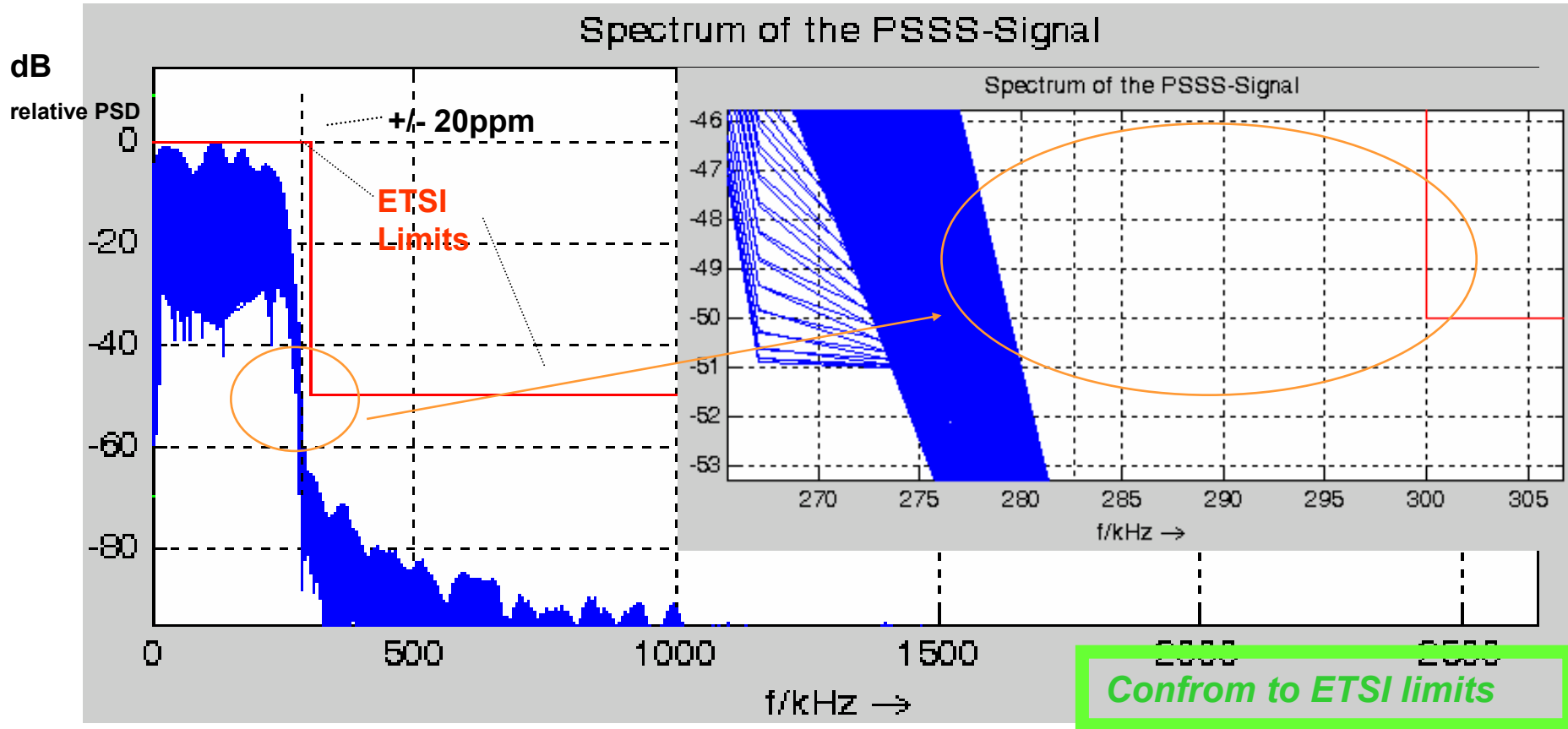

Simulations of the relative PSD in dB for the PSSS signal at 480 kchips/s, 225 kbit/s, +/- 20ppm.  
Conditions: non linear, precoding

# PSD PSSS Signal – Baseband pulse shaping, non linear, precoding

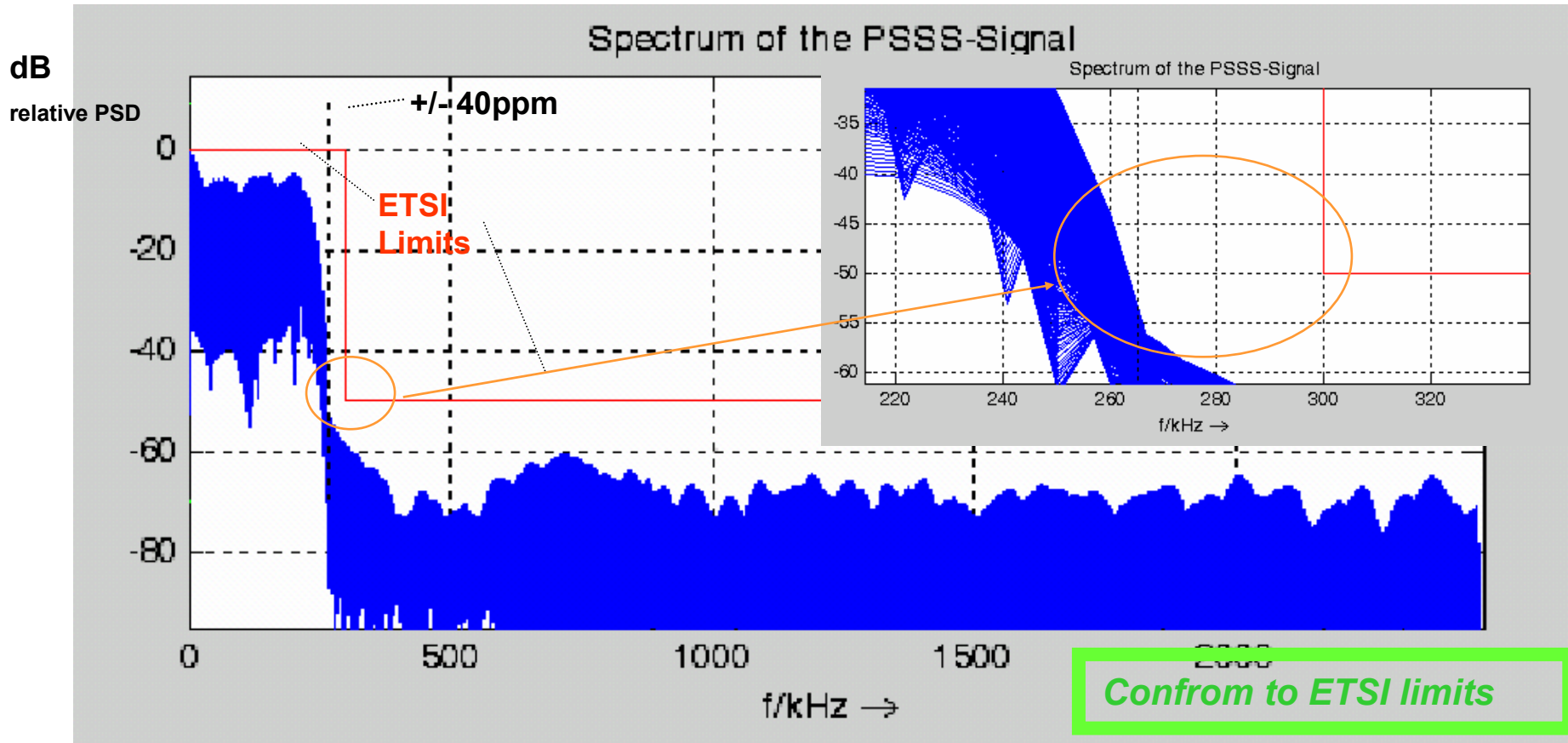

Simulations of the relative PSD in dB for the PSSS signal at 450 kchip/s 210 kbit/s, +/- 40ppm

# PSD PSSS Signal – Baseband pulse shaping, non linear, precoding

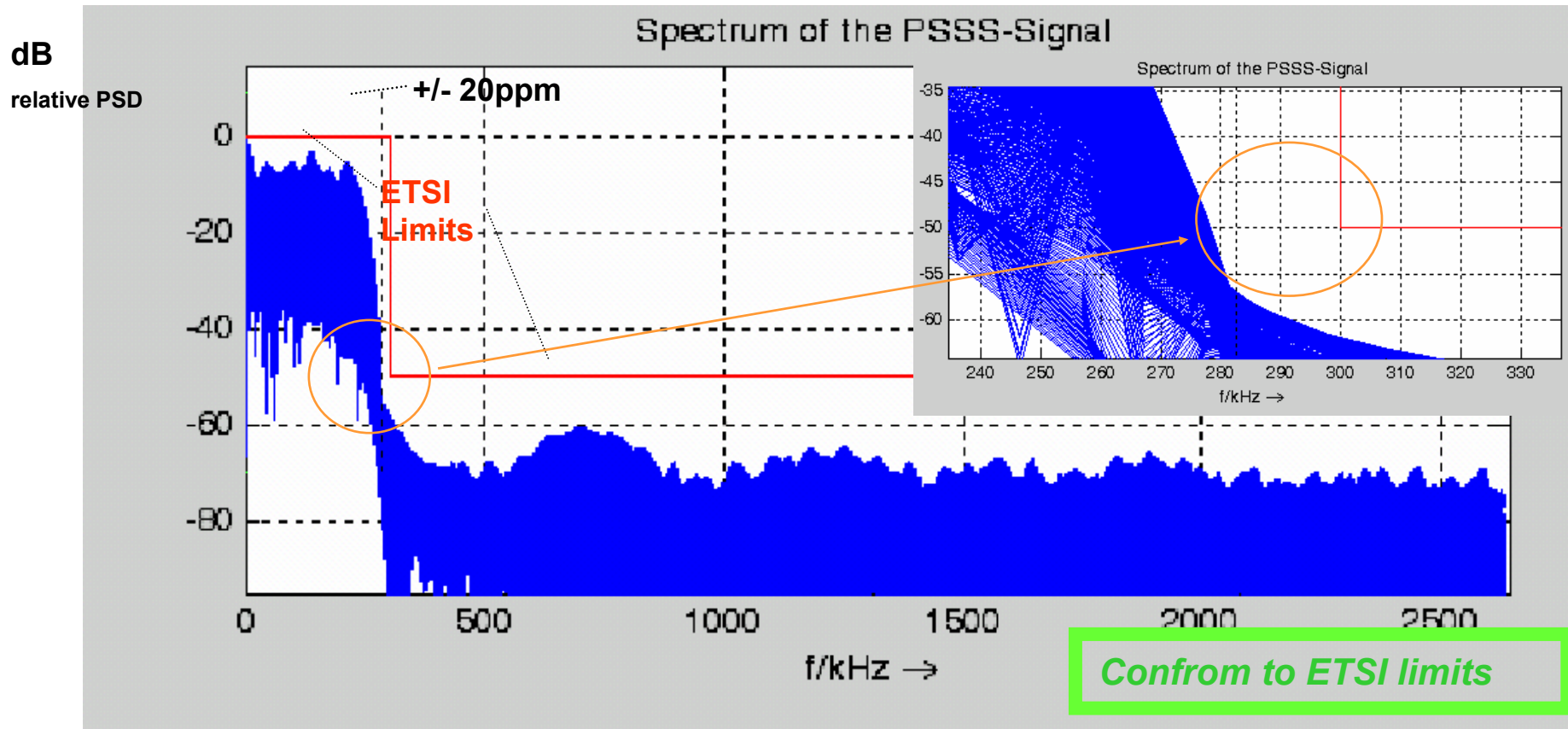

Simulations of the relative PSD in dB for the PSSS signal at 480 kchip/s, 225 kbit/s,  $\pm 20$  ppm

# PSSS IQ1 Mode

#	Code #	Spectral Efficiency	Data Rate kbs	Chiprate
1	1	0,625	250	400
2	4			
3	7			
4	10			
5	13			
6	16			
7	19			
8	22			
9	25			
10	28			

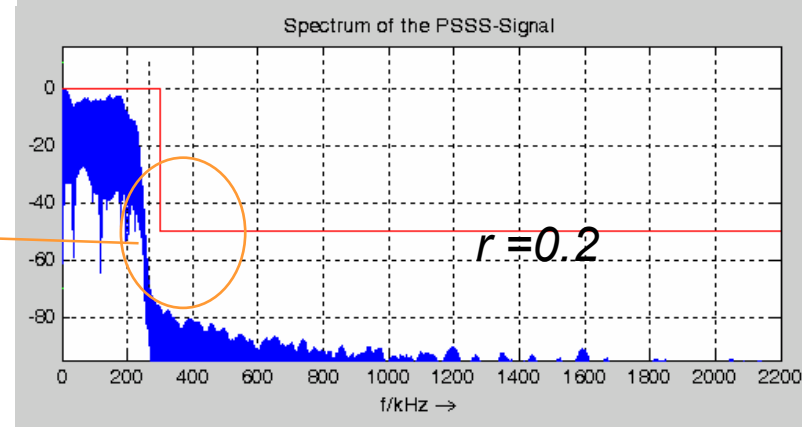
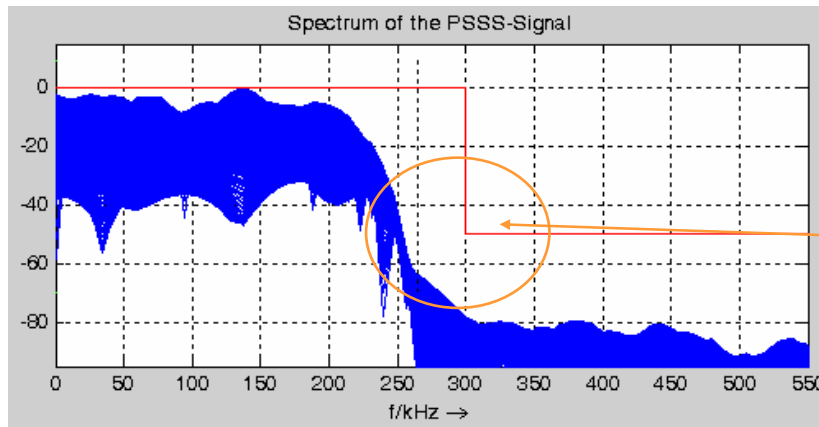
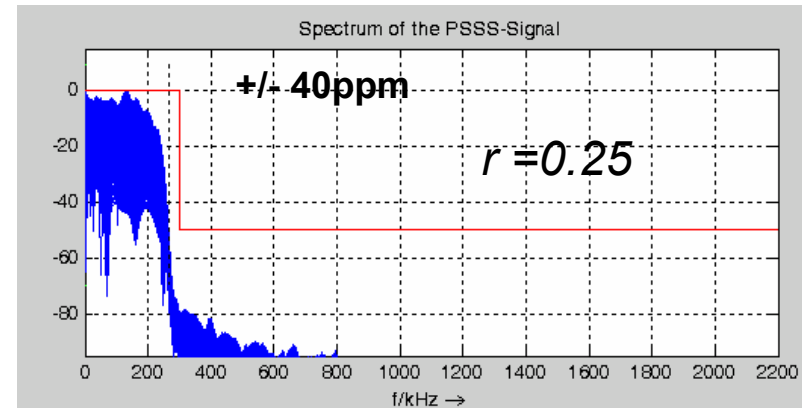

Simulations of the relative PSD in dB for the PSSS signal at 400 kchip/s 250 kbit/s.  
 Conditions: linear, precoding, +/-40 ppm,  $r = 0.25$  roll on off

**Confrom to ETSI limits**

# PSSS IQ 2 Mode

#	Code #	Spectral Efficiency	Data Rate kbs	Chiprate
1	1	0,9375	250	266,6666667
2	3			
3	5			
4	7			
5	9			
6	11			
7	13			
8	15			
9	17			
10	19			
11	21			
12	23			
13	25			
14	27			
15	29			

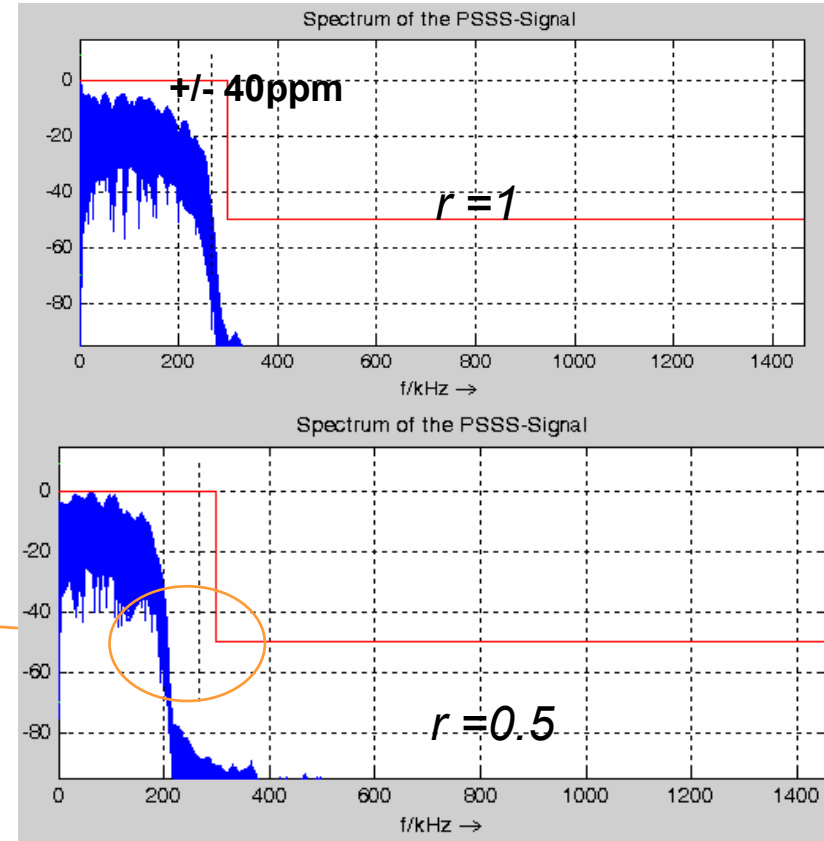
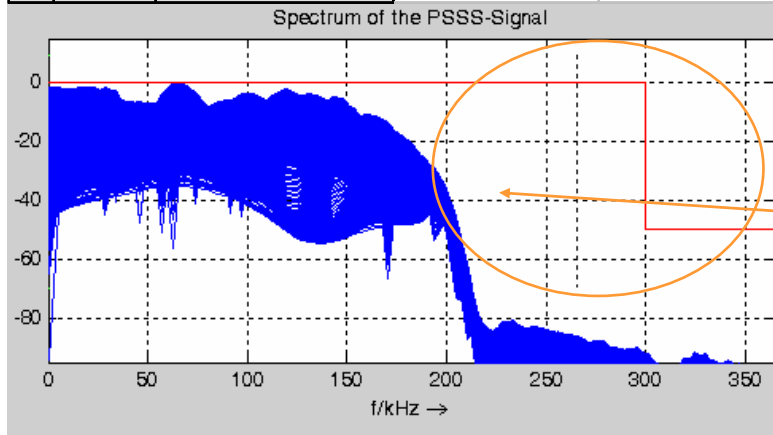

Simulations of the relative PSD in dB for the PSSS signal at 266 kchip/s 250 kbit/s.  
 Conditions: linear, precoding, +/-40 ppm,  $r = 1$  roll on off

**Confrom to ETSI limits**



# PSD for COBI8 in 600 KHz channel

## Baseband pulse shaping linear

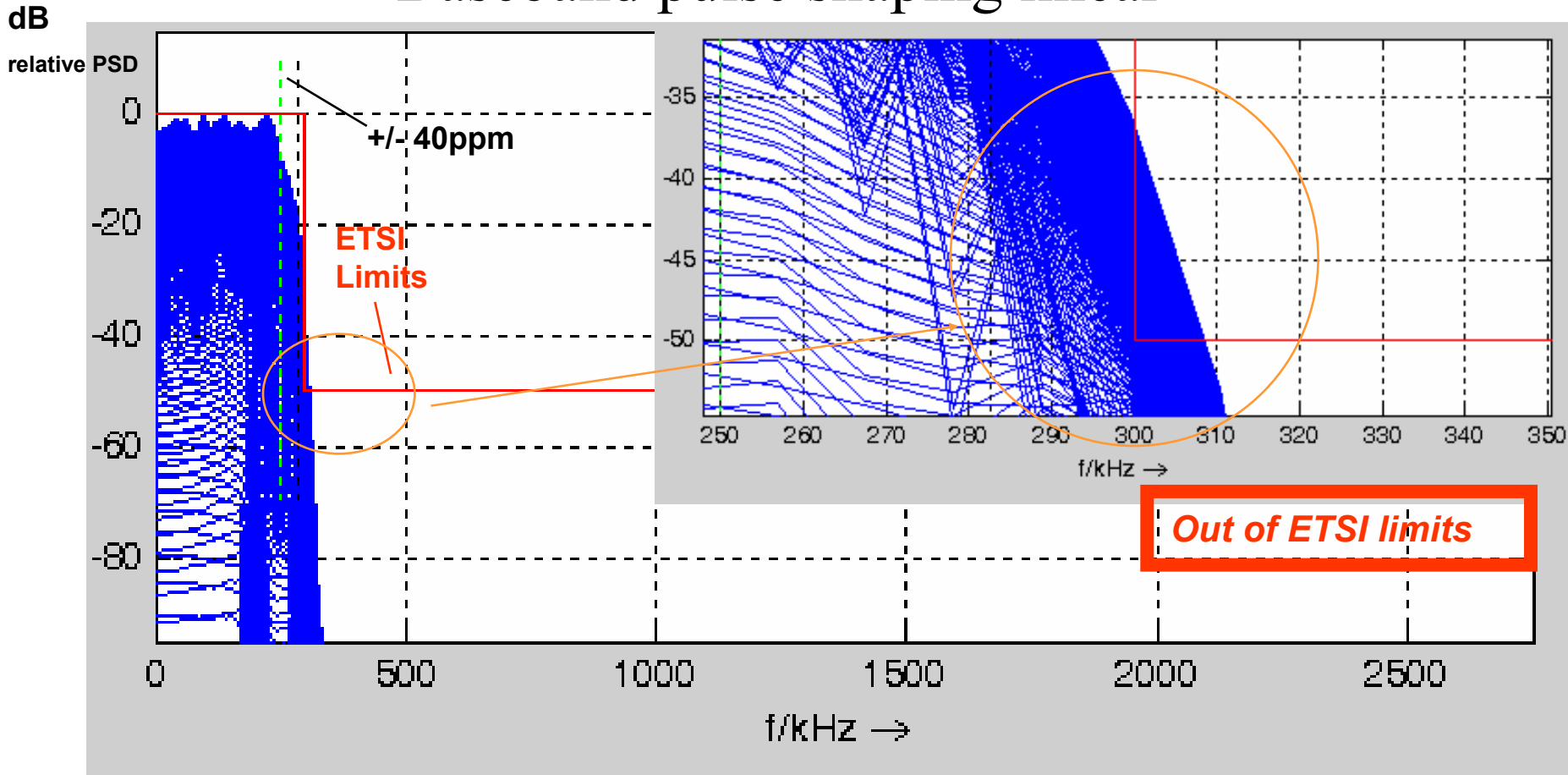

Simulations of the relative PSD in dB for the Cobi at 500 kchip/s, 250 kbit/s,  $r = 0.2$ , +/-40 ppm.

Reference for COBI 8: IEEE 802.15-04-0586-05-004b , slide 5

# PSD for COBI8 in 600 KHz channel

## Baseband pulse shaping non-linear

dB

relative PSD

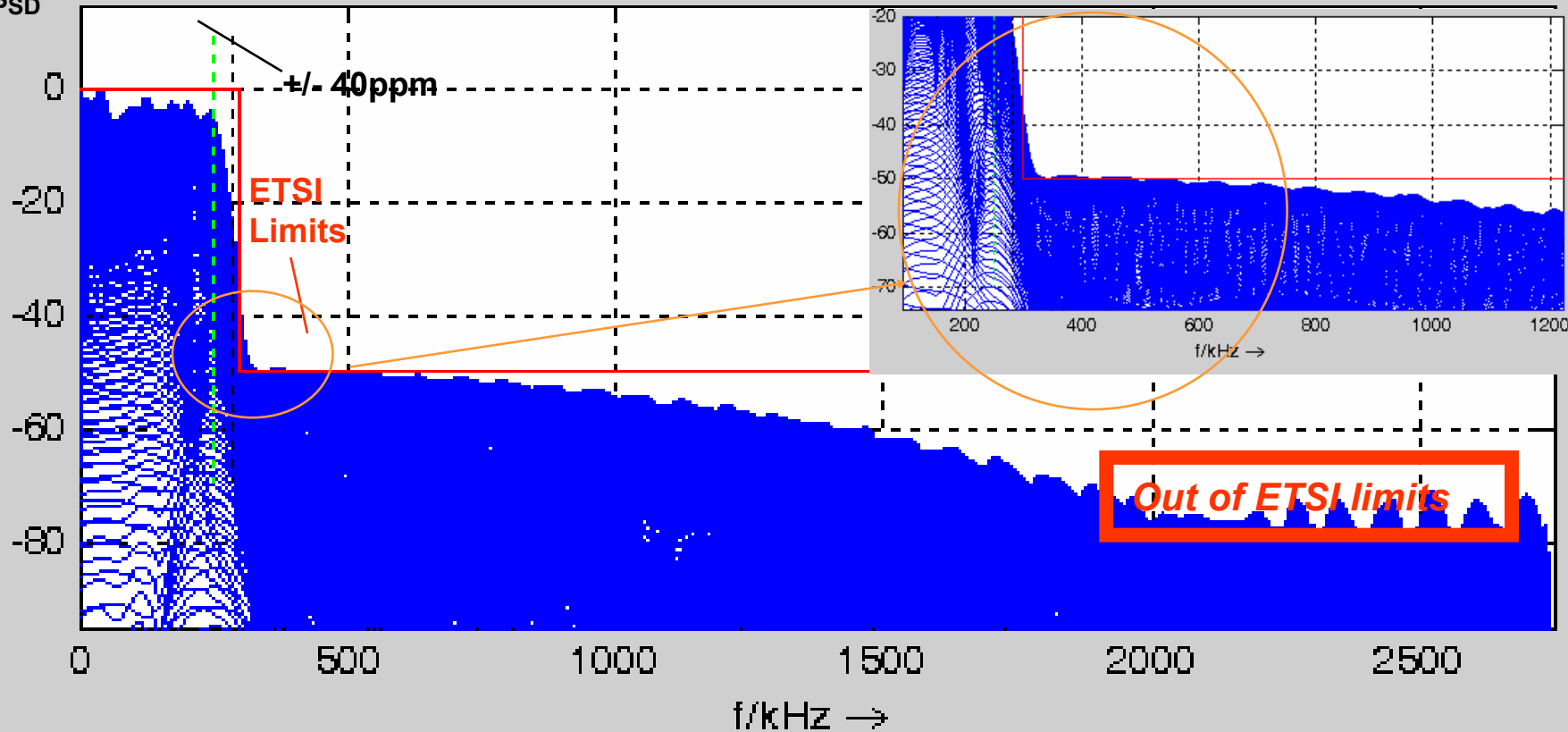

Simulations of the relative PSD in dB for the Cobi at 500 kchip/s, 250 kbit/s,  $r = 0.2$ ,  $\pm 40$  ppm.

Reference for COBI 8: IEEE 802.15-04-0586-05-004b , slide 5

# PSD for COBI8 in 600 KHz channel

## Baseband pulse shaping linear

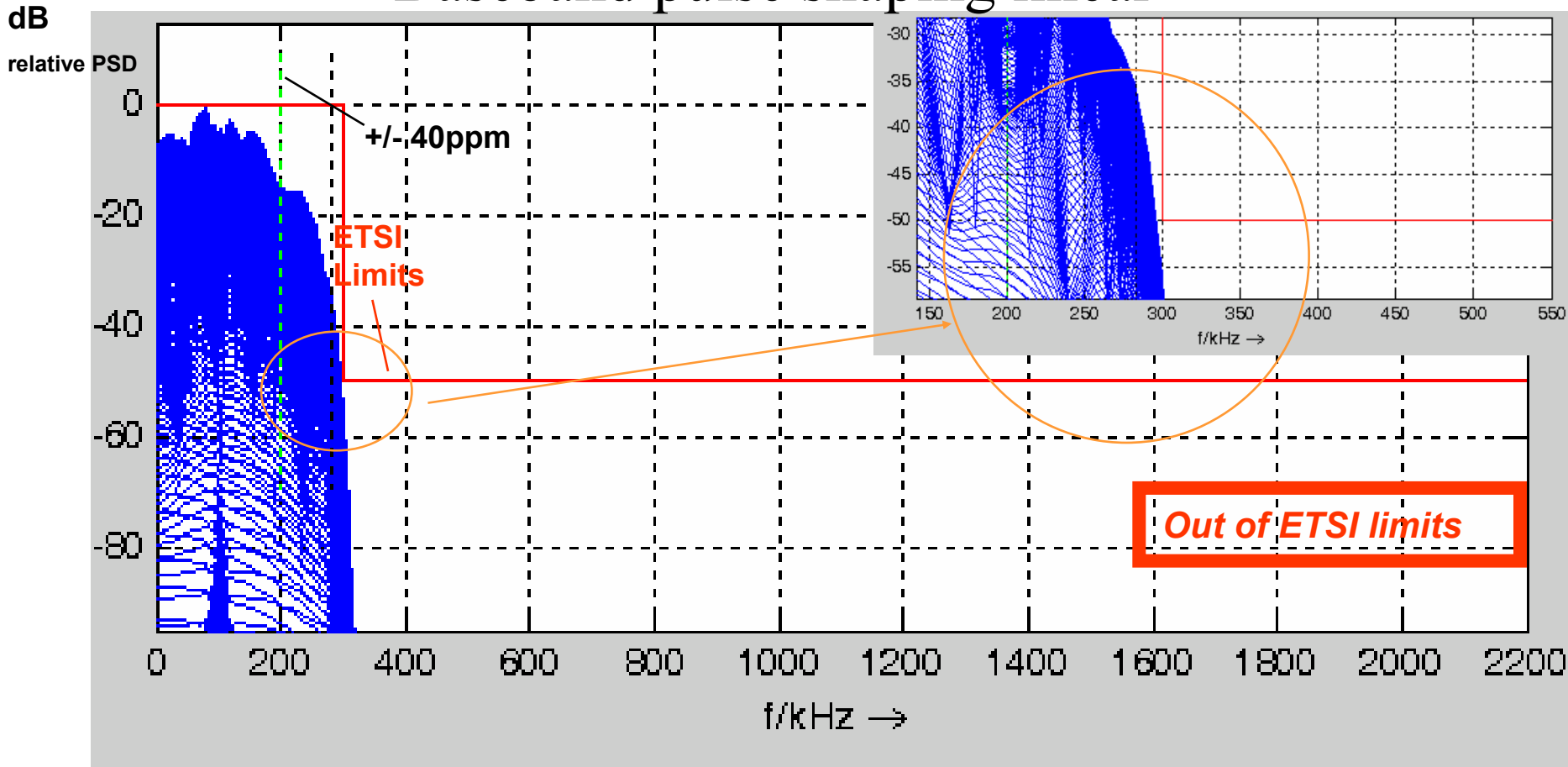

Simulations of the relative PSD in dB for the Cobi at 400 kchip/s, 200 kbit/s,  $r = 0.5$ ,  $\pm 40$  ppm.

Reference for COBI 8: IEEE 802.15-04-0586-05-004b , slide 5

# PSD for COBI8 in 600 KHz channel

## Baseband pulse shaping non-linear

dB

relative PSD

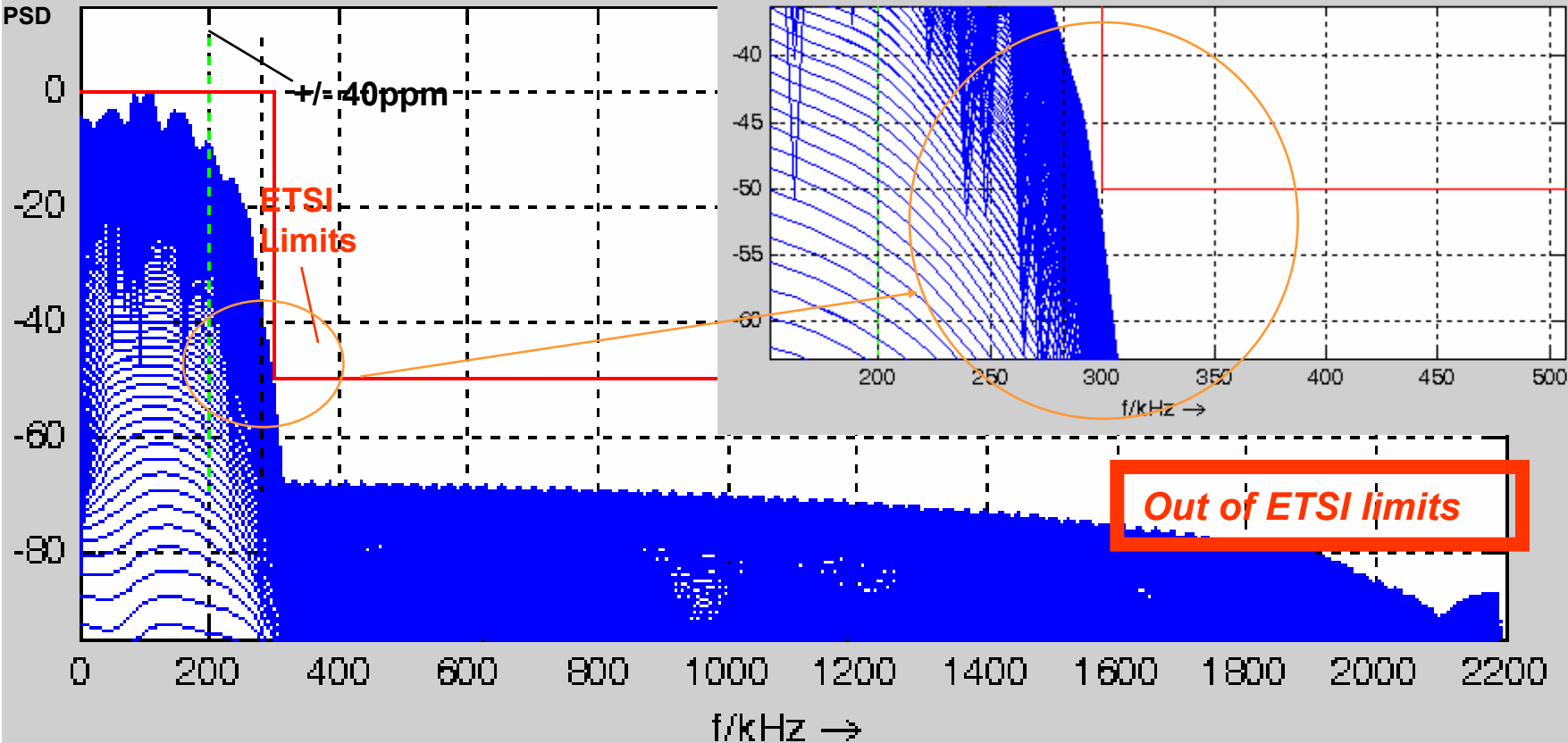

Simulations of the relative PSD in dB for the Cobi at 400 kchip/s, 200 kbit/s,  $r = 0.5$ , +/-40 ppm.

Reference for COBI 8: IEEE 802.15-04-0586-05-004b , slide 5

# PSD for COBI8 in 600 KHz channel

## Baseband pulse shaping linear

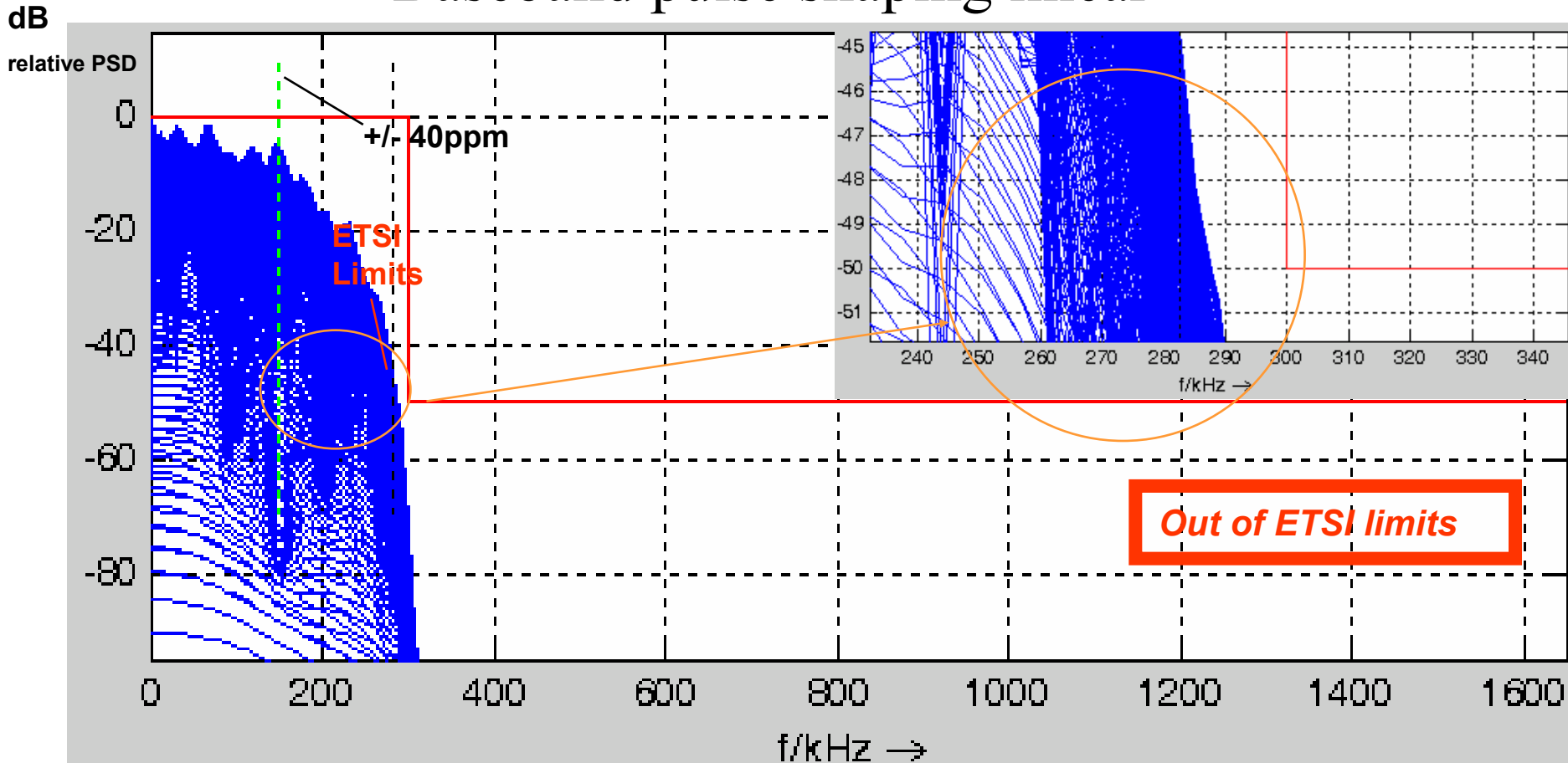

Simulations of the relative PSD in dB for the Cobi at 300 kchip/s, 150 kbit/s,  $r = 1$ , +/-40 ppm.

Reference for COBI 8: IEEE 802.15-04-0586-05-004b , slide 5

# PSD for COBI8 in 600 KHz channel

## Baseband pulse shaping non-linear

dB

relative PSD

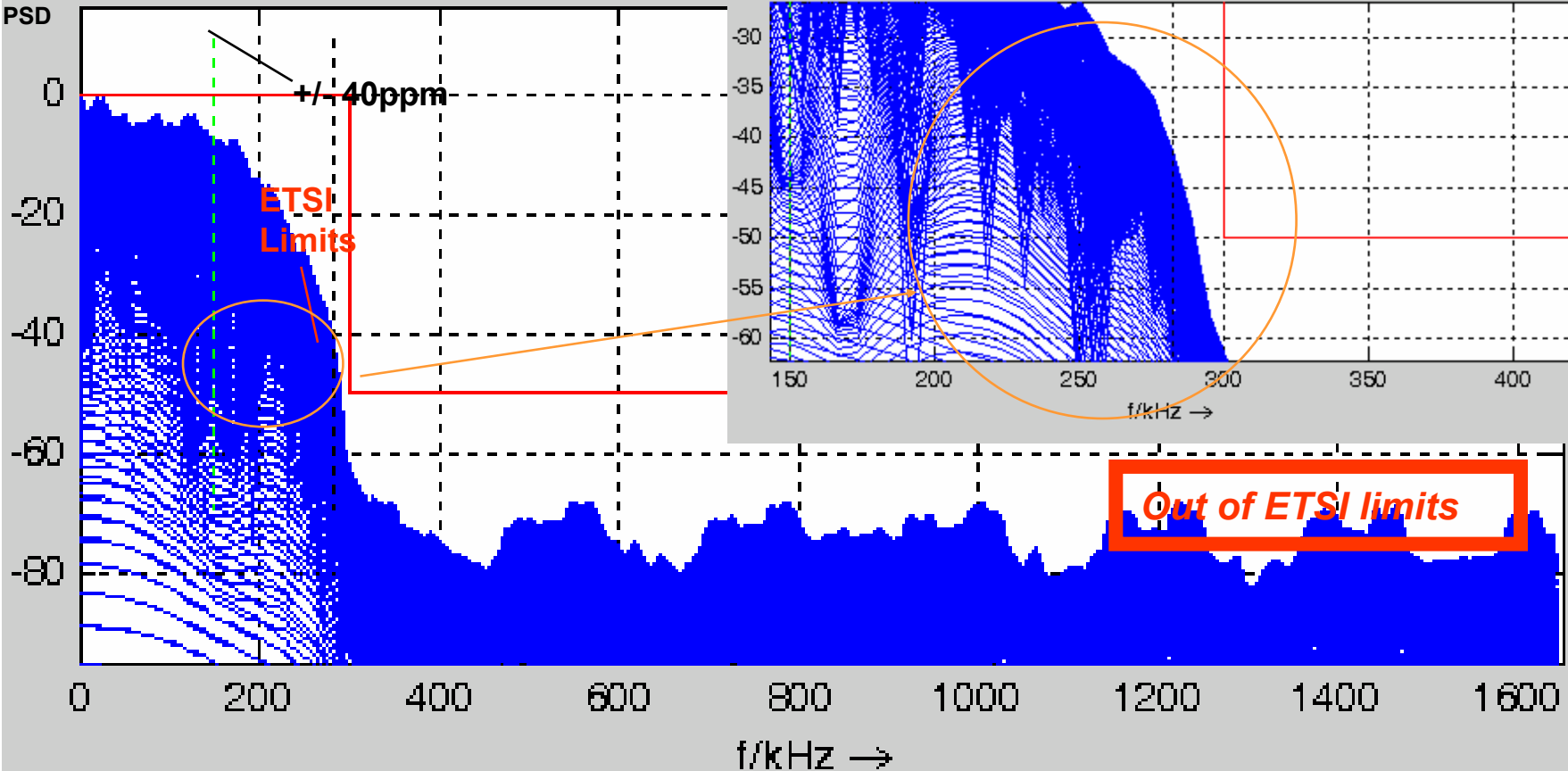

Simulations of the relative PSD in dB for the Cobi at 300 kchip/s, 150 kbit/s,  $r = 1 \pm 40$  ppm.

Reference for COBI 8: IEEE 802.15-04-0586-05-004b , slide 5

# Crystal quality, Linearity, PSD – Conclusions

- **Crystal Quality conclusions**

- PSSS could work in ETSI mask with +/-40ppm tolerance up to 250 kbit/s, depending of used coding

- **PSD Conclusions**

- PSSS matches with with up to 450/480 kchip/s (40/20 ppm) the ETSI recommendations
- Depending on pulse shaping passband / baseband Non-Linearity 20% / 1% has nearly no effect to PSD
- PSD for COBI8<sup>1</sup> at 250 kbit/s violates ETSI recommendations
- Non linearity increases also outband PSD for COBI

- **General Linearity Conclusions**

- PSSS works even with 20% non linear PA and LNA
- PA designs are available off-the-shelf with
  - No increase in chip cost even for linearity of 2%
  - No additional power consumption compared to C class PA used in IEEE802.15.4-2003 today
- No impact of linearity requirements on power consumption
  - Reviewed and confirmed with two large semiconductor manufacturers
- No implementation risk due to increased linearity required for PSSS !



- **Non-linearity simulations are confirmed with PSSS prototype**

1) Reference: IEEE 802.15-04-0586-05-004b , slide 5

# Chip size and power consumption

## Chip size

- High tolerance towards non-linearity and simplicity of PSSS minimizes increase in analog part
  - Estimate 0.25 mm<sup>2</sup> max.
- Digital part: No increase expected due to reduced complexity.
- **Total increase:** 7-10 % PHY max.  
4-6 % TRx die  
2-3 % SoC die  
**< 2% SoC cost !**
- Larger increase in size expected for COBI for Rake receiver etc.

## Power consumption

- High tolerance against non-linearity and simplicity of PSSS minimizes increase in power consumption
  - Estimate Rx/Tx: 5-10% max.  
Sleep: <0.05  $\mu$ A
- 15.4 2.4 Ghz chips today spread between 15...55 mA Rx
  - Effect of implementation + process is large vs. increase from PSSS (if any)
- **No visible change in battery lifetime**
  - Most energy for sleep+discharge
  - Longer battery life vs. current 868/915
- Visible increase expected for COBI due to Rake receiver etc.

Assumption: 0.18  $\mu$  CMOS process



## Presentation Contents

- Introduction
  - Summary of OEM requirements for the TG4b PHY
- PSSS variants reviewed in this document
- PSSS Performance
  - BPSK / ASK modulation
  - O-QPSK / I/Q modulation
- PSSS Implementation aspects
  - Crystal quality – frequency offset tolerance
  - PSD
  - Chip size and power consumption
-  Status
  - Summary
- Attachments
  - PSSS PHY Tx operation
  - Selected Rx implementation options
  - Linearity

## Status

- Comprehensive research and development on PSSS has been performed based on:
  - **Full simulation**
  - **Configurable prototype for PSSS**
  - **Analytical model for PSSS**

 Minimal risk for implementation due to well understood technology and all building blocks being widely available

## Results of first field measurements with PSSS and COBI16: Residential / light commercial environments – Small office building, heating application

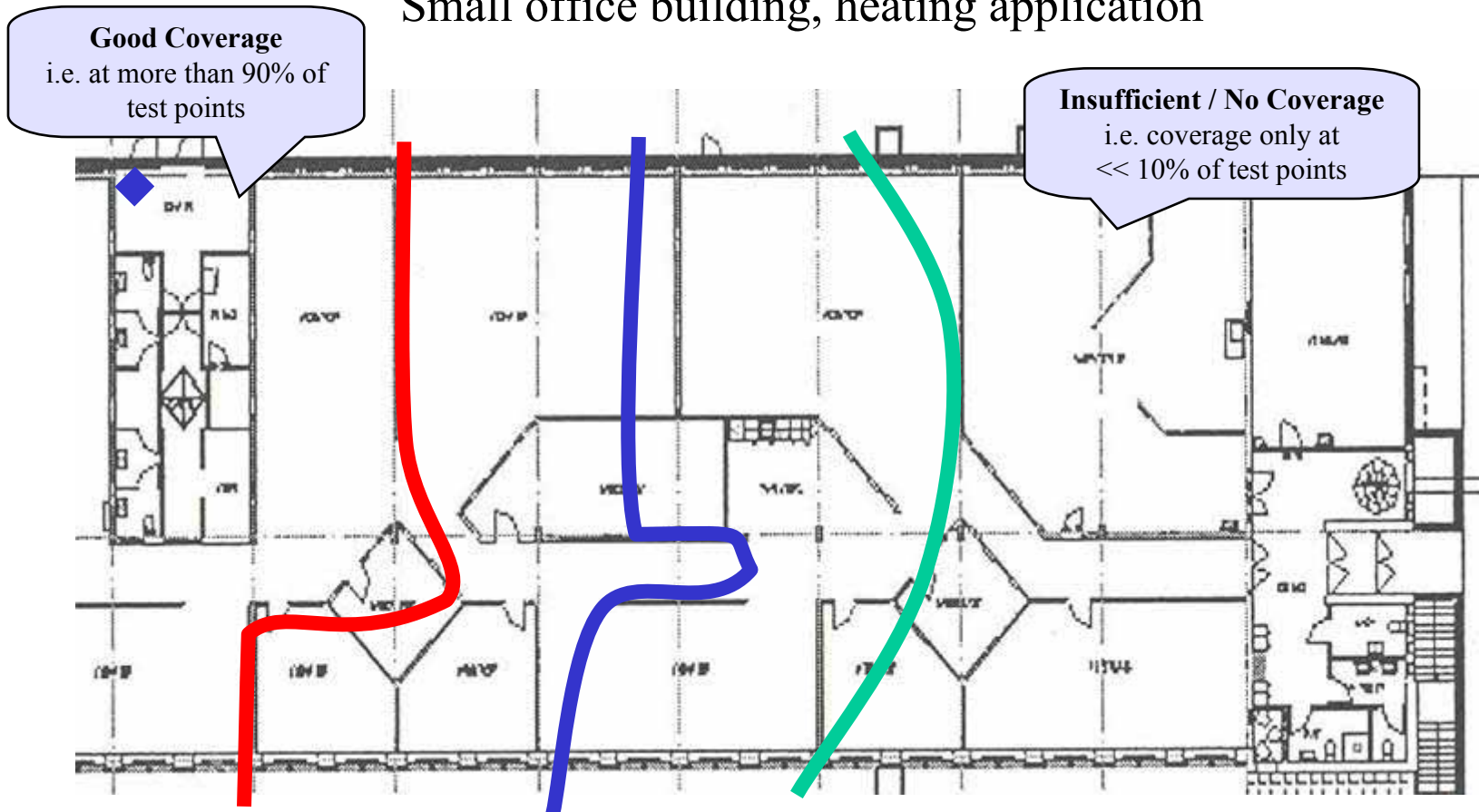

- Test site: Office building (brick, sheetrock walls), rms delay spreads typ. 200 ... 400 ns
- Tested RF technology:
  - IEEE802.15.4-2003 (2.4 GHz), 0dBm Tx
  - PSSS 225-600, 225 kbit/s (600 kHz) in 2.4 Ghz, 0dBm Tx
  - COBI16+1, 235 kbit/s (600 kHz) in 2.4 GHz, 0 dBm Tx

◆ Test transmitter

# Comparison of PHY technologies

	PSSS 225-600	PSSS 210-600	PSSS 250-600 a/b	PSSS <sup>1)</sup> 250-2000	COBI16 <sup>2)</sup>	COBI8 <sup>2)</sup>
<b>Bandwidth</b>	600 kHz	600 kHz	600 kHz	2,000 kHz	2,000 kHz	600 kHz
<b>Chiprate</b>	480 cps	450 cps	266.6 / 400 cps	800 kcps	1 Mchip/s	500 kcps
<b>Bitrate</b>	225 kbit/s	210 kbit/s	250 kbit/s	250 kbit/s	250 kbit/s	250 kbit/s
<b>Spreading</b>	15x 32-chip seq.	15x 32-chip seq.	10/15x 32-chip seq.	5x 32 chip seq.	16x16 chip seq.	16x8 chip seq.
<b>Pulse shape</b>	Square root raised cosine r = 0.2	Square root raised cosine r = 0.2	Square root raised cosine r = 0.5 / 0.2	Square root raised cosine ?	Halfsine	<b>Raised cosine R = 0.2 Not possible<sup>3)</sup></b>
<b>Rake</b>	Not required	Not required	Not required	Not required	Required <sup>1)</sup>	Required <sup>1)</sup>
<b>Modulation</b>	BPSK + ASK	BPSK + ASK	<b>BPSK + I/Q</b>	BPSK + ASK	OQPSK	BPSK
<b>Complexity</b>	small	small	<b>Small to medium</b>	small	high	high
<b>MP performance <math>E_b N_0</math> @ PER=10<sup>-3</sup></b>	31dB	31dB	27dB/30dB	?	>>40dB	>>>40dB
<b>Conclusion</b>	Attractive	Highly Attractive	Attractive	Highly Attractive	Less Attractive	Not Attractive

Joint PHY (Sept. 2004)

Advantage

Disadvantage

**Blocking point**

2) Reference: IEEE 802.15-04-0586-05-004b

1): Not yet fully simulated, may still not provide required MP performance

**3): Also other proposed COBI8 versions are not conform to ETSI rec.**

## Summary

- PSSS is the only proposal that fulfills all OEM requirements
  - Provides very high robustness against MP fading – up to 2  $\mu$ s  
i.e. visibly stronger MP fading robustness than current 2.4 GHz PHY,  
provides required higher range in many attractive, high volume target areas
  - Data rate of > 200 kbit/s at low complexity with highly backward compatible PHY,  
250 kbit/s with even simpler pulse shaping with I/Q modulation/demodulation
  - Suitable for existing and upcoming regulatory environment in Europe (ETSI)
- Analysis in TG4b has shown that PSSS is implementable at low risk
  - High confidence in results due to very comprehensive simulation model
  - Simulation results match first measurements with lab prototype
  - Full understanding of PSD shows compliance with stringent ETSI requirements
- PSSS offers highly attractive performance and increases market opportunities
  - Performance of COBI is lower than with current 2.4 GHz PHY coding
  - PSSS is competitive with Bluetooth radios in industrial / commercial environments
- PSSS provides for Europe significantly more attractive solution than COBI
  - Lower COBI16 performance is acceptable for US  
*if* higher permitted Tx power is used (only if feasible with regard to PSD!)
  - Use of Rake receiver is inconsistent with IEEE802.15.4 objectives

# Attachments

## Changes vs. PSSS presentation at March 2004 meeting (Orlando)

- **Unchanged basic proposal for parallel reuse of 2.4 GHz PHY!**
  - Added option of use of BPSK/ASK instead of O-QPSK
    - Based on OEM and semiconductor manufacturers requirements
    - To avoid added complexity and cost for two radio cores
    - To avoid doubling required bandwidth for O-QPSK
  - Added option to reduce 868 Mhz bandwidth to 500 Khz
    - Changed to reduce implementation complexity and cost
    - Bitrate of 234 kbit/s changed to 225 kbit/s based on input from September 2004 meeting to have “more even” bit rate
    - 210 kbit/s and 250 kbit/s variants added based on chip manufacturer’s inputs in TG4b PHY subcommittee to even further reduce implementation cost
  - Details of combining provided that were not shown in March 2004
    - Coding gain through simple precoding in combiner
- Added new results on PSSS
  - Solution performance
  - Implementation aspects
  - Status

# Used Matlab Code for Discrete Channel

```
L=2
% L=2 equal 370 ns RMS Delay Spread
profile = zeros(1,10*L+1);
profile(1:L:end) = exp(-(0:10)/2);
profile = profile/(sum(profile));
channel = sqrt(profile/2).*(randn(size(profile))+j*randn(size(profile)));
signal_out = zeros(size(signal_in));
for k = 0:10
    signal_out=signal_out+channel(k+1)*[zeros(1,k*L) signal_in(1:length(signal_in)-k*L)];
end
```

## Source:

Paul Gorday Freescale IEEE 802.15-04-0585-00-004b, slide 9



# PSSS – Tx – BPSK/ASK variant (15/32 bit/s/Hz)<sup>1</sup>

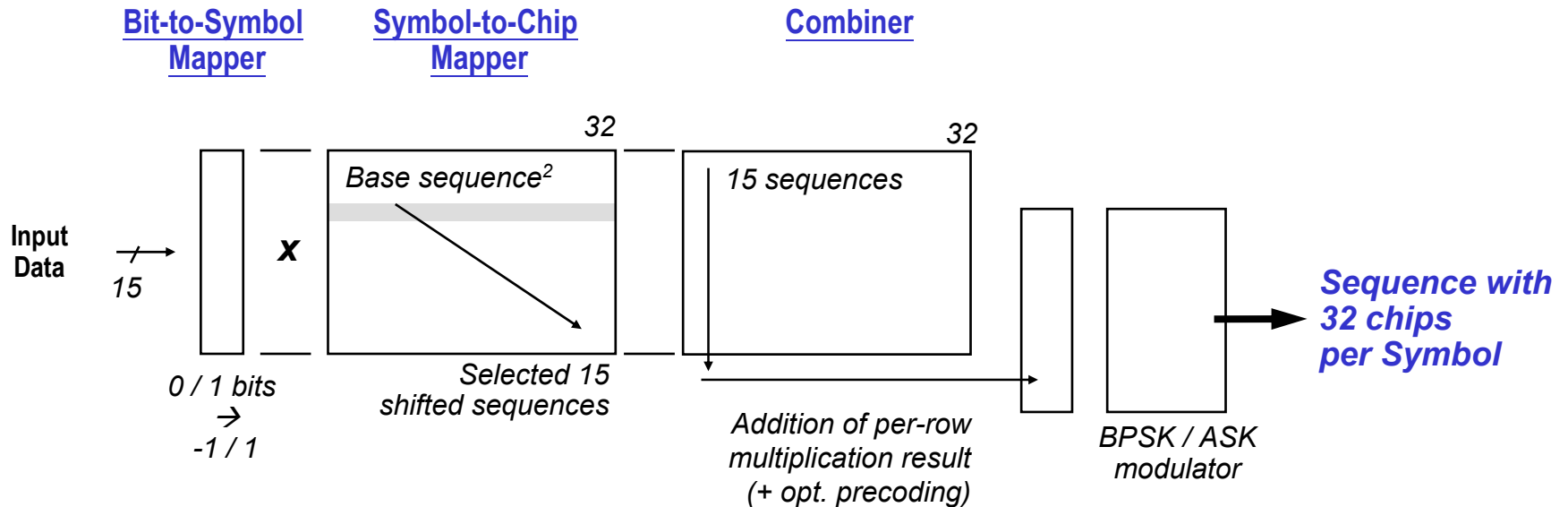

*...addition of multiple parallel sequences  
instead of selection of single sequence*

1: PSSS 225-600 + PSSS 210-600

2: Use of single base sequence simplifies implementation in Rx

# PSSS –BPSK/ASK option (15/32 bit/s/Hz) – Coding table

## Symbol-to-Chip Mapper

# Bit	Chip Values																																				
1	-1	-1	-1	-1	1	-1	-1	1	-1	1	1	-1	-1	1	1	1	1	-1	-1	-1	1	1	1	-1	1	1	1	-1	1	-1	1	-1	1	-1	1	-1	
2	-1	1	-1	-1	-1	-1	1	-1	-1	1	-1	1	1	-1	-1	1	1	1	1	-1	-1	-1	1	1	-1	1	1	1	-1	1	1	1	-1	1	-1	1	-1
3	-1	1	-1	1	-1	-1	-1	1	-1	-1	1	-1	1	1	-1	-1	1	1	1	1	-1	-1	-1	1	1	-1	1	1	-1	1	1	1	-1	1	1	1	-1
4	1	1	-1	1	-1	1	-1	-1	-1	-1	1	-1	-1	1	-1	1	1	-1	-1	1	1	1	1	1	-1	-1	-1	1	1	-1	1	1	-1	1	1	1	
5	-1	1	1	1	-1	1	-1	1	-1	-1	-1	-1	1	-1	-1	1	1	-1	-1	1	1	1	1	1	1	-1	-1	-1	1	1	-1	1	1	-1	1	-1	
6	1	1	-1	1	1	1	-1	1	-1	1	-1	-1	-1	1	-1	-1	1	-1	1	1	-1	-1	1	1	1	1	1	1	1	1	1	1	-1	-1	-1	1	
7	-1	-1	1	1	-1	1	1	1	-1	1	-1	1	-1	-1	-1	1	-1	-1	1	-1	1	1	-1	-1	1	1	1	1	1	1	1	1	1	1	-1	-1	
8	1	-1	-1	-1	1	1	-1	1	1	1	-1	1	-1	1	-1	-1	-1	1	-1	-1	1	-1	1	-1	1	1	-1	-1	1	1	-1	-1	1	1	1	1	
9	1	1	1	-1	-1	-1	1	1	-1	1	1	1	-1	1	-1	-1	-1	-1	1	-1	-1	1	-1	1	-1	1	1	-1	1	1	-1	-1	1	1	1	1	
10	1	1	1	1	1	-1	-1	-1	1	1	-1	1	1	-1	1	-1	1	-1	-1	-1	1	-1	-1	1	-1	-1	1	-1	-1	1	1	-1	1	-1	-1	1	
11	-1	-1	1	1	1	1	1	-1	-1	-1	1	1	-1	1	1	1	-1	1	-1	1	-1	-1	-1	1	-1	-1	1	-1	-1	1	-1	1	1	1	-1	1	-1
12	1	1	-1	-1	1	1	1	1	1	-1	-1	-1	1	1	-1	1	1	1	-1	1	-1	1	-1	-1	-1	-1	-1	-1	1	-1	-1	1	-1	-1	1	-1	1
13	1	-1	1	1	-1	-1	1	1	1	1	1	-1	-1	-1	1	1	-1	1	1	1	-1	1	-1	1	-1	-1	-1	-1	-1	-1	-1	-1	-1	-1	-1	-1	1
15	-1	-1	1	-1	1	1	-1	-1	1	1	1	1	1	-1	-1	1	1	-1	1	1	1	-1	1	-1	1	-1	1	-1	1	-1	-1	-1	-1	-1	-1	-1	1
15	-1	1	-1	-1	1	-1	1	1	-1	-1	1	1	1	1	1	-1	-1	-1	1	1	-1	1	1	1	-1	1	-1	1	-1	1	-1	1	-1	-1	-1	-1	-1
	1	2	3	4	5	6	7	8	9	10	11	12	13	14	15	16	17	18	19	20	21	22	23	24	25	26	27	28	29	30	31	32					



# PSSS –BPSK/ASK option (15/32 bit/s/Hz) – Precoding

1. Align PSSS symbol maxima symmetrical to 0
2. Scale PSSS symbol to amplitude limit

Minimal Resolution after precoding: 5 bit

Note:

Higher resolution further improves performance, but does not limit interoperability

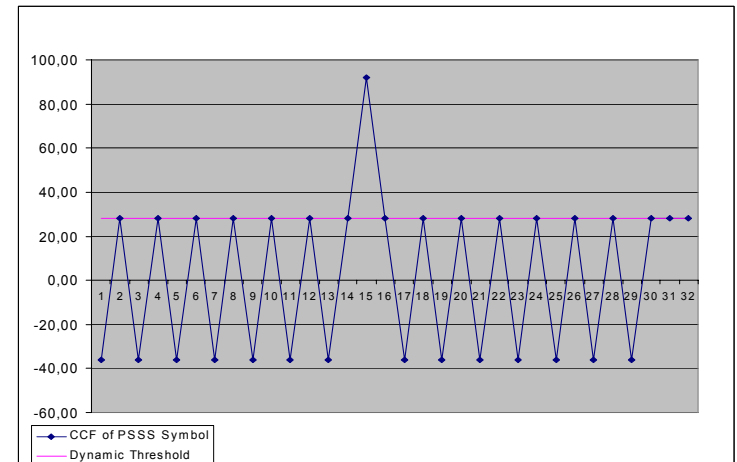
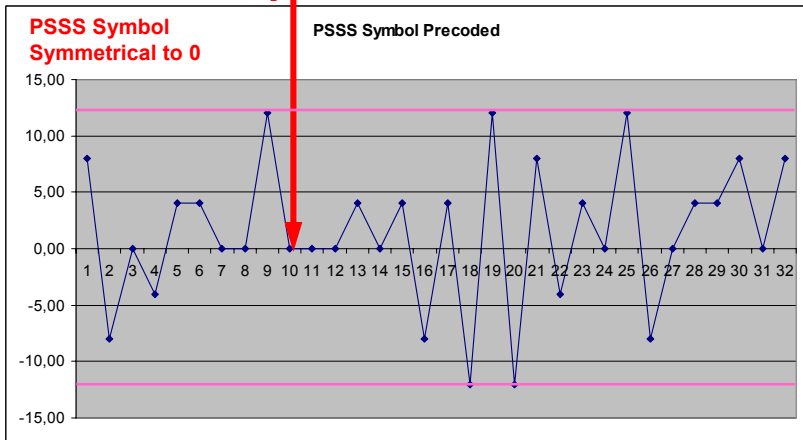
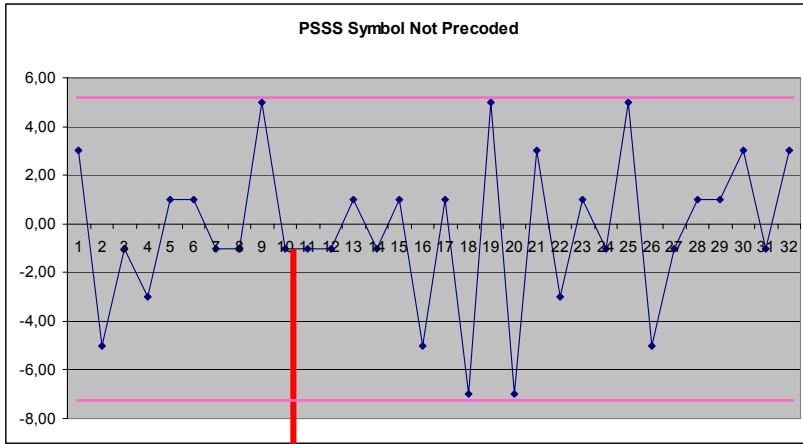

Tx

Rx

# PSSS Amplitude Histogram With Precoding

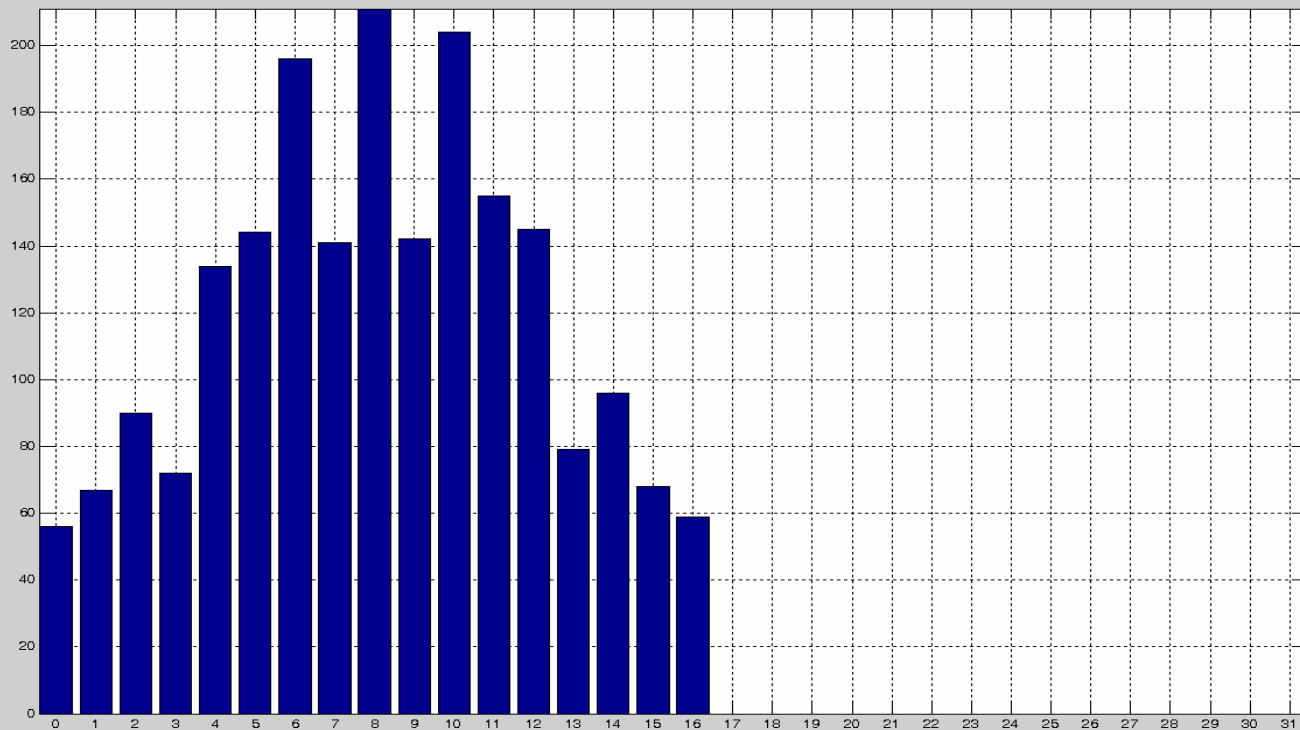

**17 levels -> 5 bit resolution**

# IEEE802.15.4-2003 2.4 GHz PHY – Rx architecture example (1/16 Bit/s/Hz)

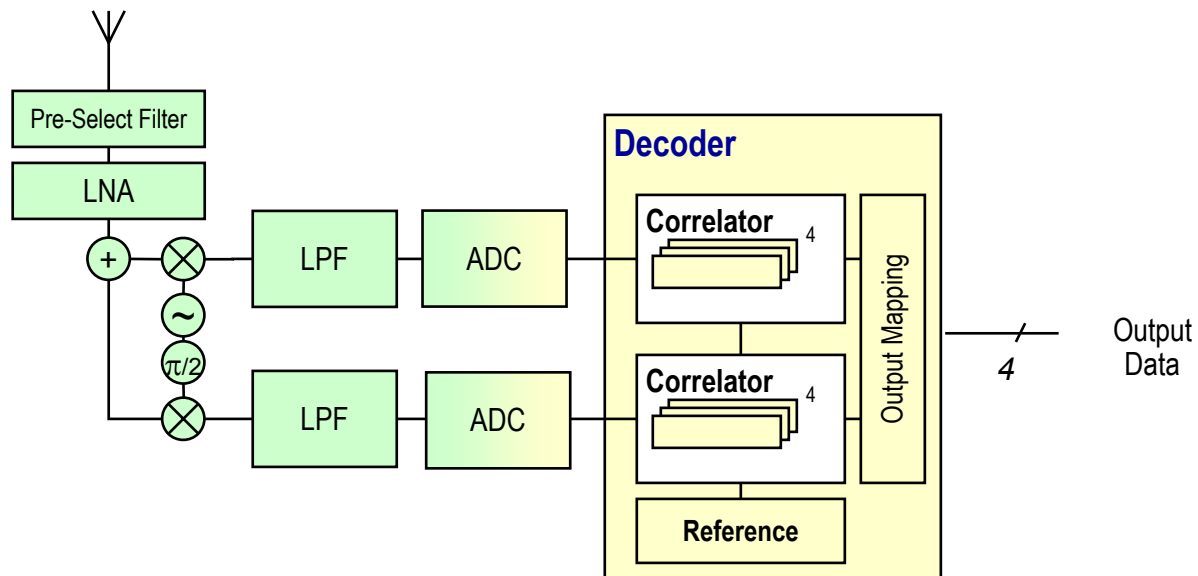

Digital
  Analog

**Note:**

Most existing IEEE802.15.4 2.4 GHz chips are built with  $\geq 4$ -bit ADCs

PSSS - 8 Times parallel 2.4 GHz PHY derivate –  
 Rx: Original O-QPSK / I/Q proposal (1/2 bit/s/Hz) –  
 Digital correlation example

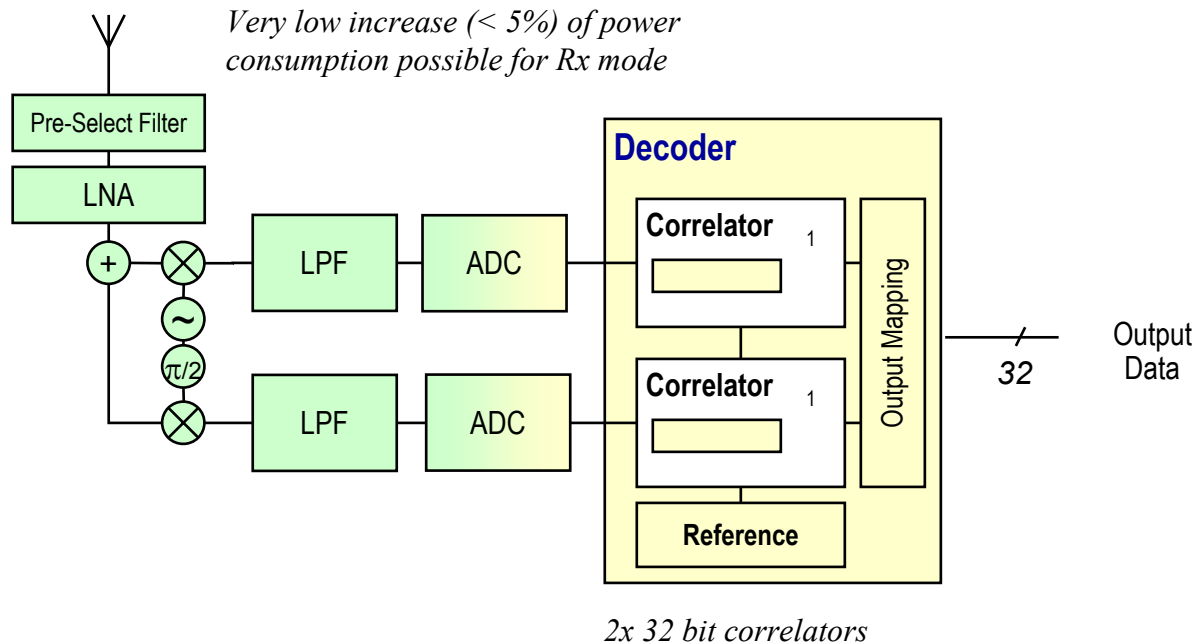

Digital     Analog

**Note:**

Most existing IEEE802.15.4 2.4 GHz chips are built with  $\geq 4$ -bit ADCs

# PSSS - 8 Times parallel 2.4 GHz PHY derivate – Rx: Original O-QPSK / I/Q proposal (1/2 bit/s/Hz) – Analog correlation example

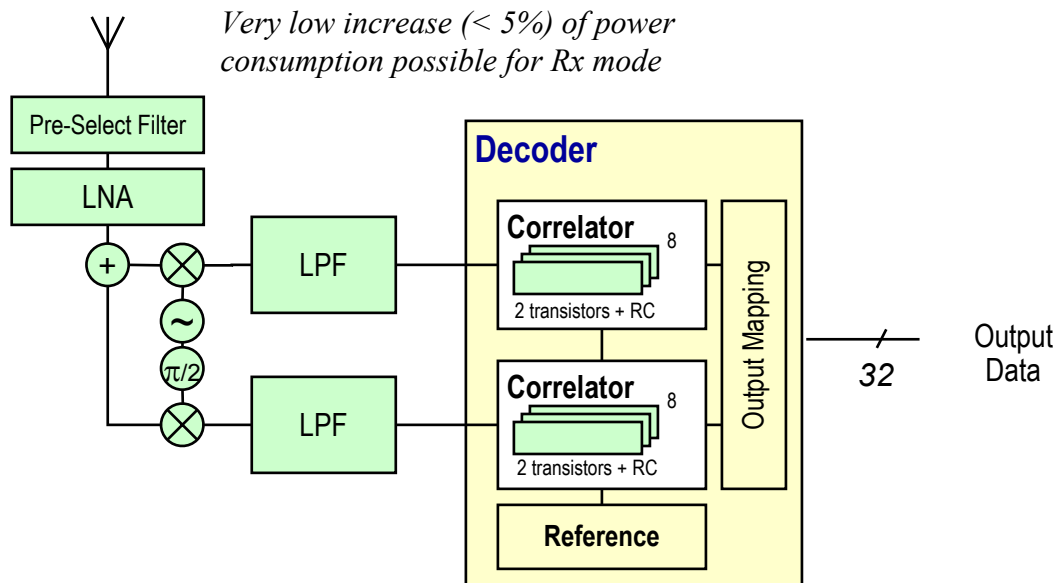

*No ADCs vs. Halfrate*

*16 analogue integrate & dump, approx. 5-10k gates reduction (no 2x 4x32 bit correlators)*

**Note:**  
The Rx example architectures shown (digital, analog, FIR correlator) and the modulation variant can be freely combined

Digital
  Analog



PSSS - 8 Times parallel 2.4 GHz PHY derivate –  
 Rx - BPSK/ASK option (15/32 bit/s/Hz) –  
 FIR filter correlation example

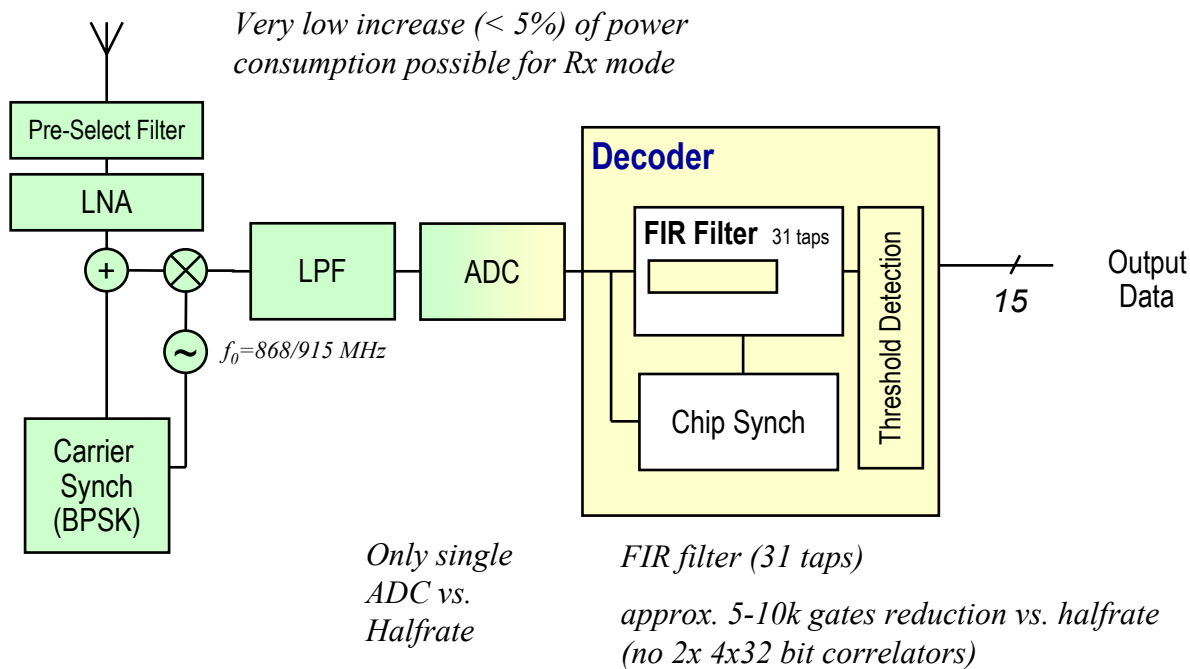

Digital
  Analog

# Linearity – Transfer function for non-linear system simulated

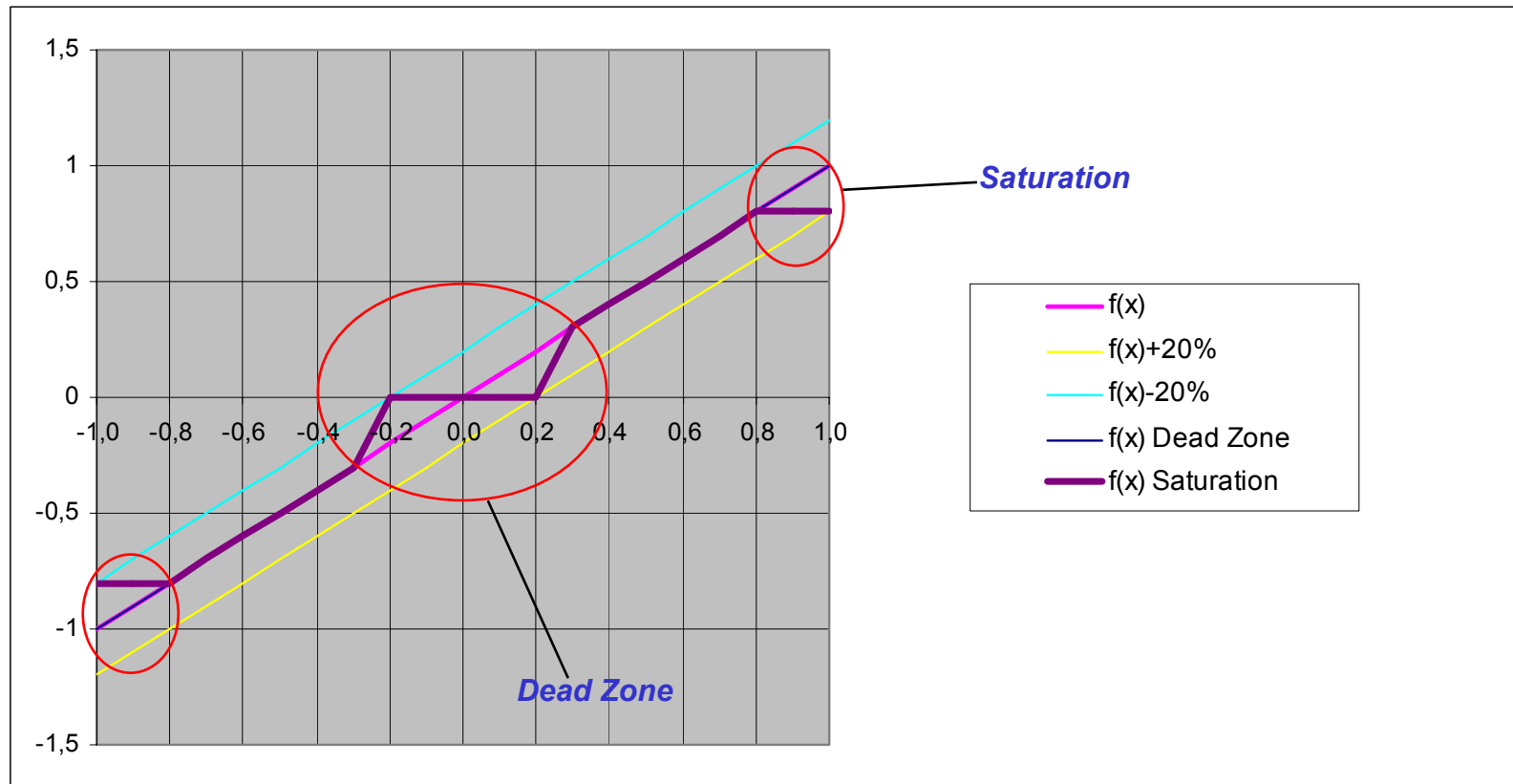

# Linearity – Simulation results

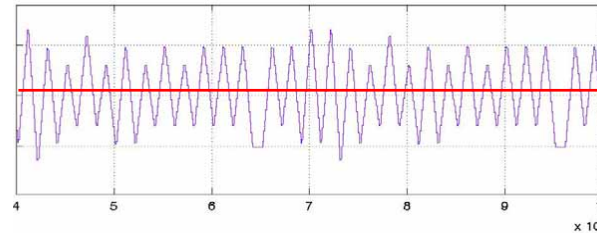
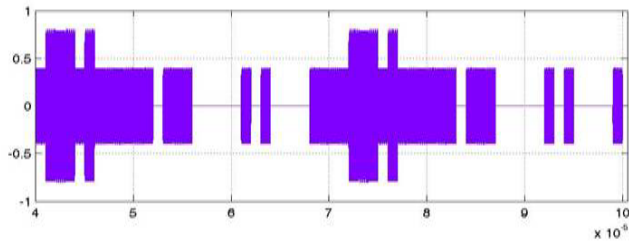

20% non-linearity

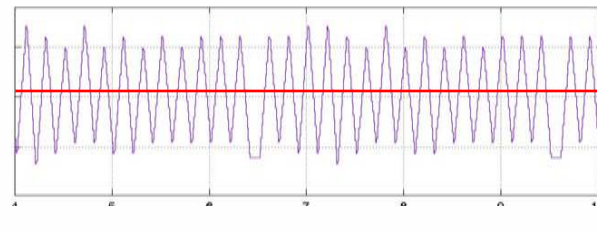
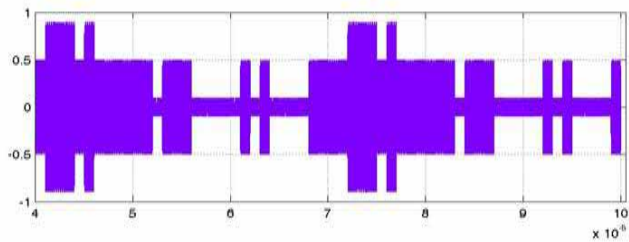

10% non-linearity

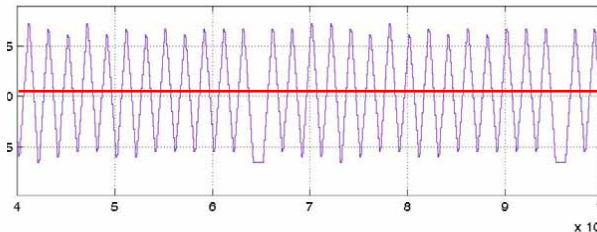
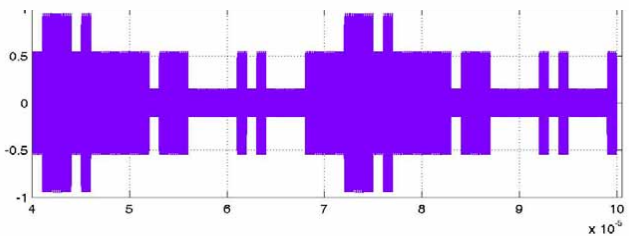

5% non-linearity

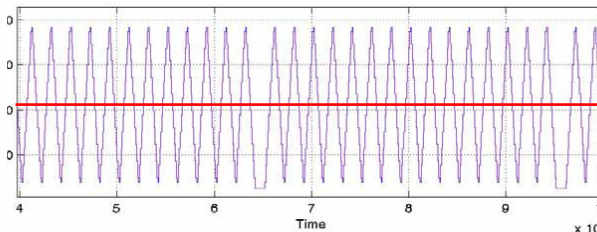
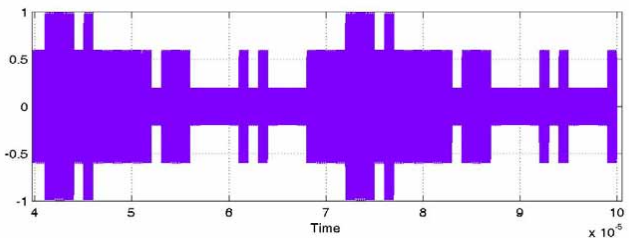

0% non-linearity

— Detection threshold (for '0' or '1' data bits)