

Project	<b>IEEE 802.16 Broadband Wireless Access Working Group</b> < <a href="http://ieee802.org/16">http://ieee802.org/16</a> >		
Title	<b>Zones and more details on the 802.16m frame structure for improved intra-system coexistence</b>		
Date Submitted	<b>2008-01-16</b>		
Source(s)	Mariana Goldhamer Alvarion Ltd. 21A, Ha Barzel Street Tel Aviv	E-mail:	<a href="mailto:mariana.goldhamer@alvarion.com">mariana.goldhamer@alvarion.com</a>
Re:	Call for Contributions IEEE 802.16m-07/047 - Proposed 802.16m Frame Structure with special attention to legacy support		
Abstract	This contribution adds more options to the basic frame for intra-system coexistence and enhances the concept of Zones		
Purpose	Actions: 1. Modification of ToC 2. Capture of the text in the SDD		
Notice	<i>This document does not represent the agreed views of the IEEE 802.16 Working Group or any of its subgroups. It represents only the views of the participants listed in the "Source(s)" field above. It is offered as a basis for discussion. It is not binding on the contributor(s), who reserve(s) the right to add, amend or withdraw material contained herein.</i>		
Release	The contributor grants a free, irrevocable license to the IEEE to incorporate material contained in this contribution, and any modifications thereof, in the creation of an IEEE Standards publication; to copyright in the IEEE's name any IEEE Standards publication even though it may include portions of this contribution; and at the IEEE's sole discretion to permit others to reproduce in whole or in part the resulting IEEE Standards publication. The contributor also acknowledges and accepts that this contribution may be made public by IEEE 802.16.		
Patent Policy	The contributor is familiar with the IEEE-SA Patent Policy and Procedures: < <a href="http://standards.ieee.org/guides/bylaws/sect6-7.html#6">http://standards.ieee.org/guides/bylaws/sect6-7.html#6</a> > and < <a href="http://standards.ieee.org/guides/opman/sect6.html#6.3">http://standards.ieee.org/guides/opman/sect6.html#6.3</a> >. Further information is located at < <a href="http://standards.ieee.org/board/pat/pat-material.html">http://standards.ieee.org/board/pat/pat-material.html</a> > and < <a href="http://standards.ieee.org/board/pat">http://standards.ieee.org/board/pat</a> >.		

# Zones and more details on the 802.16m frame structure for improved intra-system coexistence

Mariana Goldhamer  
Alvarion Ltd.

## Introduction

This contribution provides more details in relations with the Frame Structure proposed in the contribution IEEE C802.16m-08/039 [1].

We start with remanding the proposed Frame structure. In continuation we present variants of this approach, with reduced implementation complexity.

The Zone scheduling concept should be changed, in order to allow a more flexible approach of the radio resource and interference management. We introduce concepts which allow this target.

## Frame type 1 – OFDMA domain

The reason for introducing this type of frame structure was explained at large in the contribution IEEE C802.16m/08-aaa. The proposed 802.16m frame combines the Reuse 1 and Reuse 3 operations, inside a single frequency channel. The “Reuse 1” implies that all the sectors in a Base Station will use the same frequency partition, while the “Reuse 3” implies that each frequency partition is used by a single sector. Such partitions, each including a number of sub-channels are call DLSET and ULSET, for respectively DL and UL.

The next figures summarize the proposals in C802.16m/08-aaa for the 16m frame with 3 sectors and 4 sectors base stations.

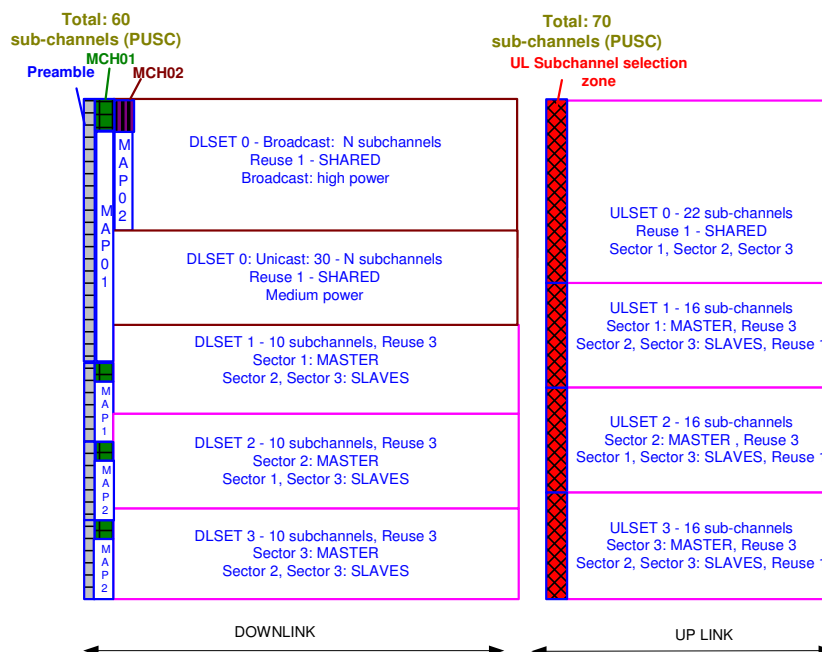
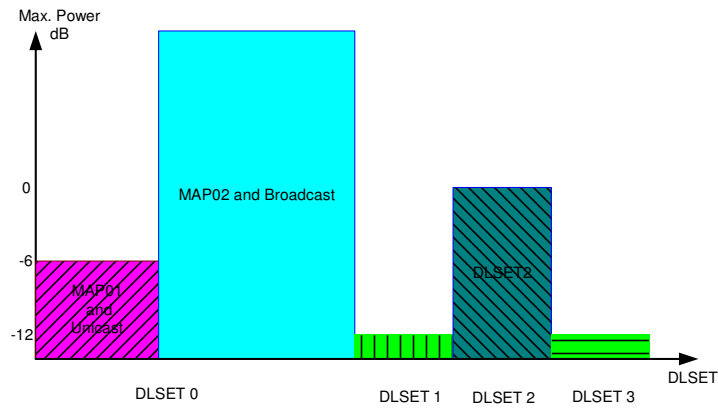
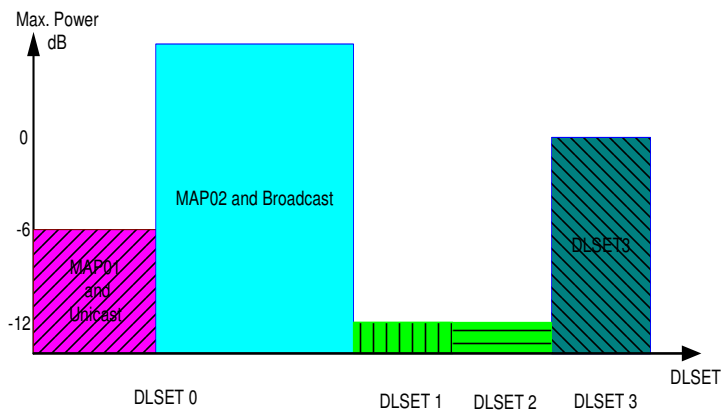

Fig. 1 Frame structure suitable to flexible SET allocations

We remind the power rules for reduced inter-cell interference:



**Fig. 2 Example of power limitations for different SETs in Sector 2**



**Fig. 3 Example of power limitations for different SETs in Sector 3**

We also remind the frame structure for a combined frequency Reuse for deployments using 4 sectors.

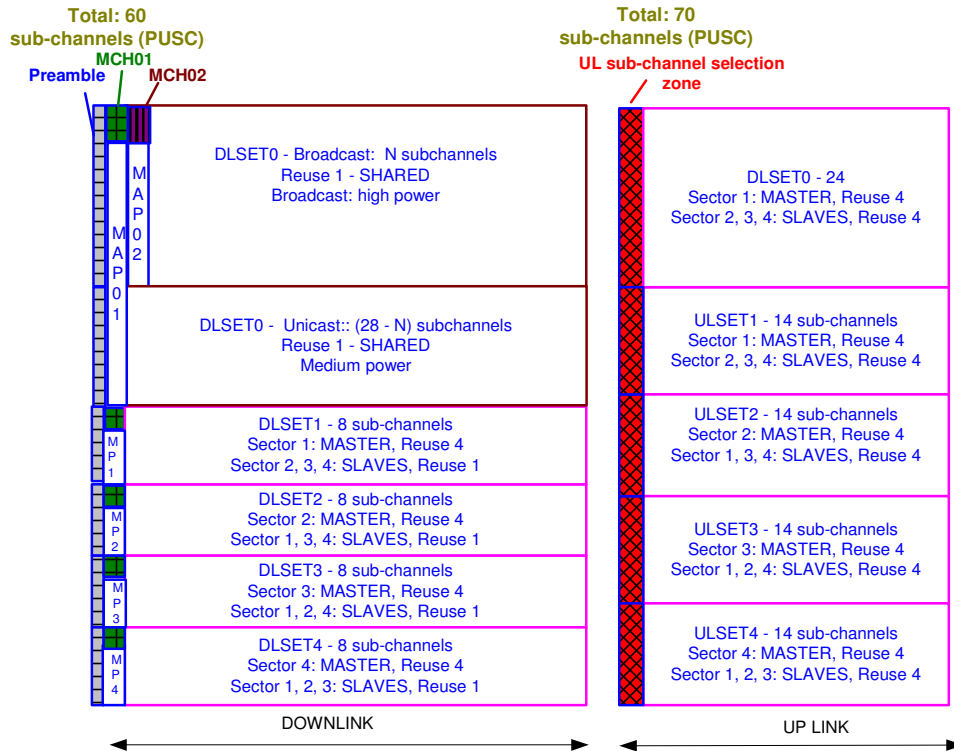

Fig. 4 Frame structure suitable to 4 sector deployments

Start text for SDD

**Frame type 2 – alternate frames**

Another possible approach consists in the separation of the Reuse 1 activity and Reuse 3 activity in alternate Frames. With this approach the Reuse 1 activity can be concentrated in the first Frame, while the Reuse 3 activity can be concentrated in a second Frame. Fig. 5 shows such a combined approach, which implies that the SSs will receive the relevant DL traffic every two Frames.

The general time/frequency DL allocation is presented in Fig. 5, while the UL allocation is presented in Fig. 6.

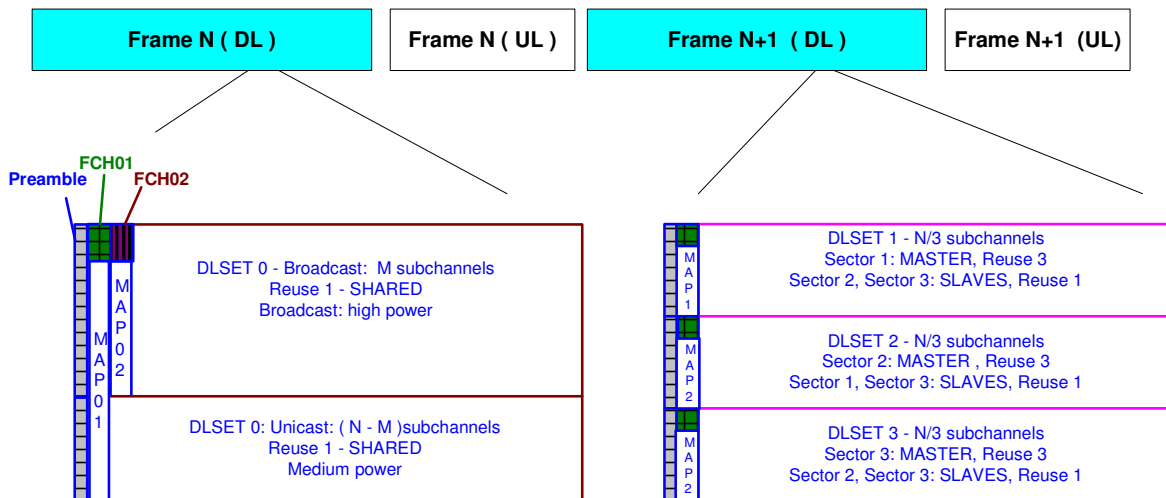

Fig. 5 DL frame structure suitable to 3 sector deployments, alternate frames

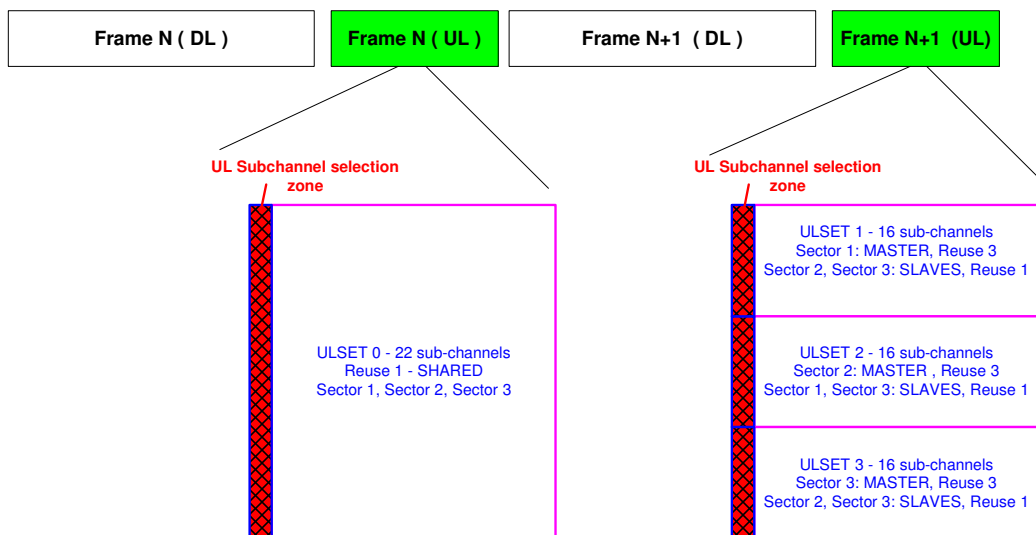

Fig. 6 UL frame structure suitable to 3 sector deployments, alternate frames

The drawback of this approach is the higher delay and the reduced granularity, limited by the Frame duration. Another variant, suitable to large broadcast activity will be to allocate two Frames for Reuse 1 and one Frame for Reuse 3.

### Frame type 3 – OFDMA frame split approach

Another possible variant enjoying low delay is the split of the Frame between Reuse 1 and Reuse 3. However the overhead due to MAC headers and MAPS will be higher as compared with the Type 1.

Fig. 7 and fig. 8 show respectively the DL and UL Frame structure. Each of DL and UL sub-frame is split between the Reuse 1 and Reuse 3 operation.

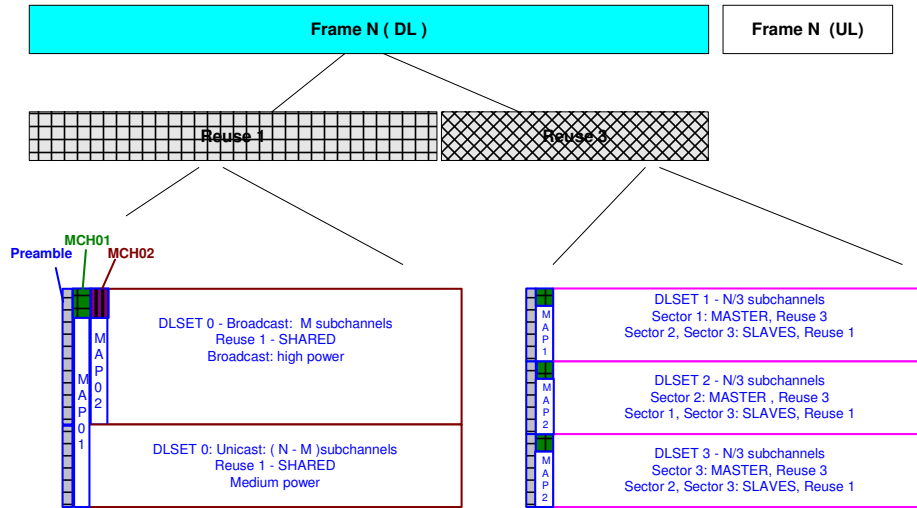

Fig. 7 DL frame structure suitable to 3 sector deployments, time split of the Frame

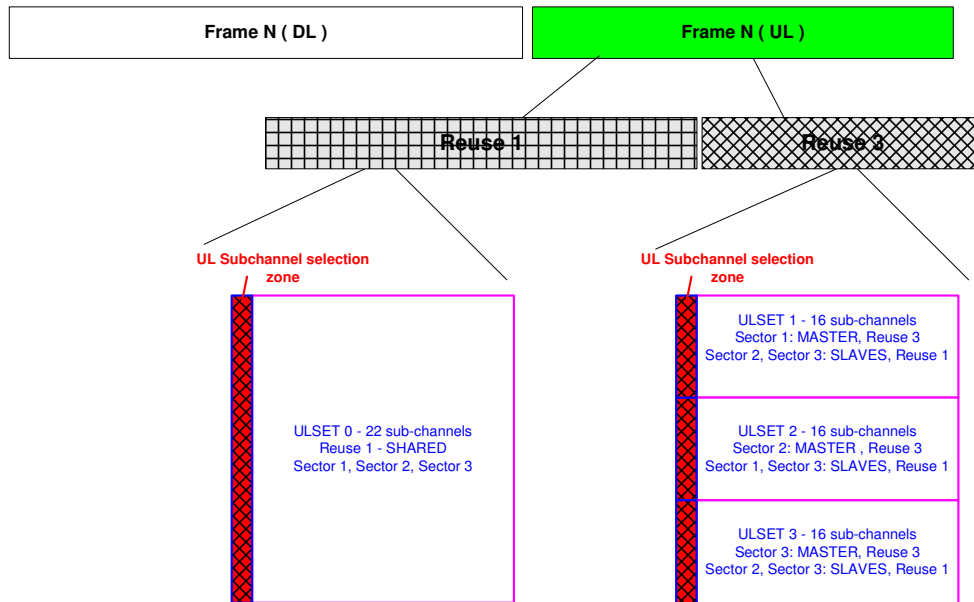
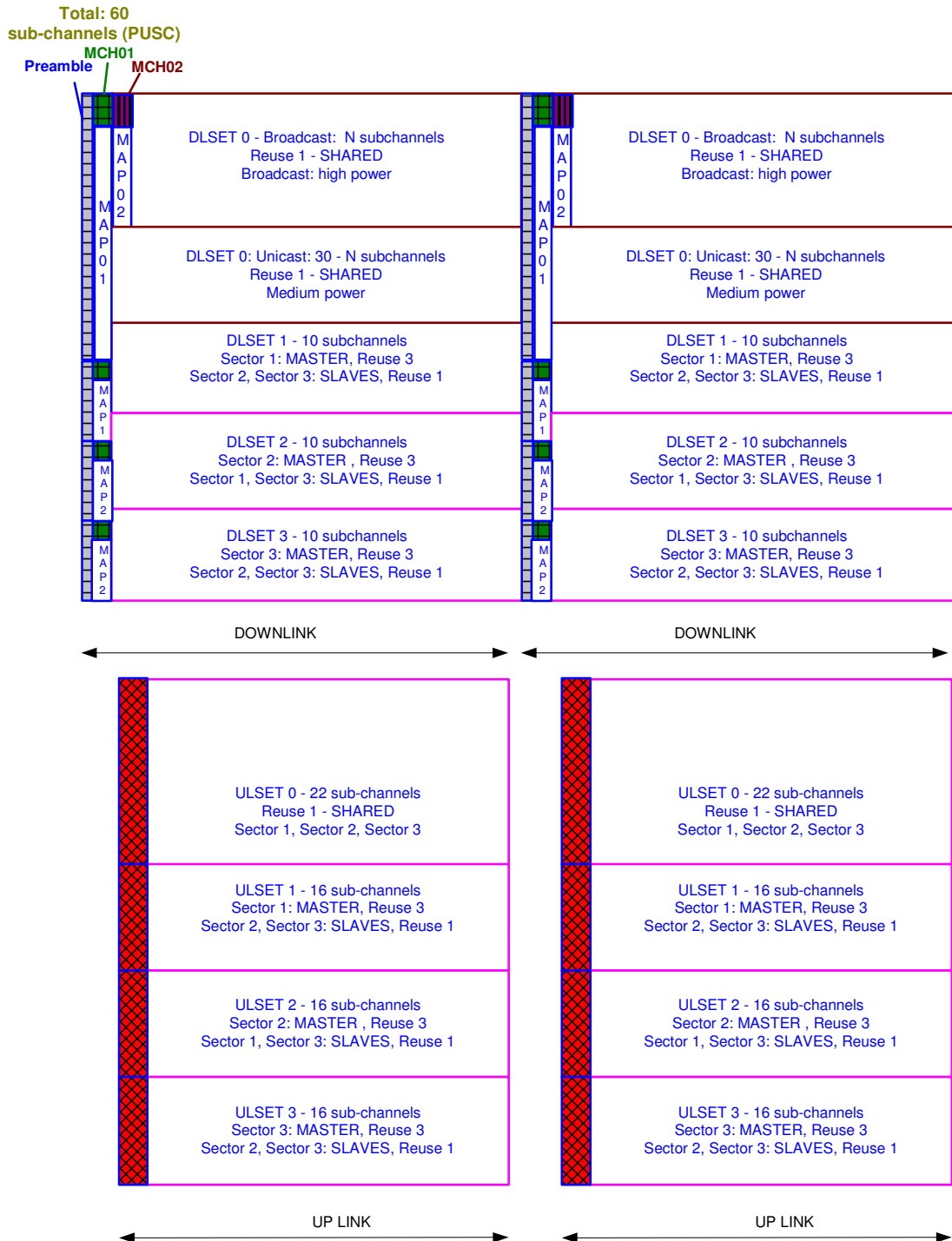

Fig. 8 UL frame structure suitable to 3 sector deployments, time split of the frame

## FDD (Frequency Division Duplex) Operation

The FDD operation should be suitable to H-FDD (Half-duplex FDD) SS (Subscriber Station) operation. In order to achieve this, the SSs operation shall not be scheduled during the Preambles, MCH and MAP transmission. Fig. 9 shows an example of Frame arrangement for FDD operation.



**Fig. 9 Frame for FDD operation**

## ZONES inside SETs

The existing 802.16e ZONES inside a Frame are basically differentiated according to the used approach for increasing the range and capacity. However, a SS has to find the ZONE location based on the decoding of the MAP at the start of FRAME and this limits the range of operation and also increases the requested time for MAP transmission, due to the low modulations used.

The most efficient allocation of ZONES within every set is done if the allocation is as long as possible in frequency domain, in order to reduce the overhead generated by eventual preambles, MAPs and MAC headers.

The solutions to these problems should be able to place at well known sub-channel and time locations (preferably the Start of Frame) the preambles specific to every zone, the MCH (MAP Control Header) and the MAP of the Zone. Further, a zone can be organized with different bursts according to the modulation and coding used. The spectral efficiency is increased if we can directly use the high performance zones, instead of starting the operation in the frame with lower performance zones.

## SET organization in ZONES

In fig. 10 is shown the split of a SET in further ZONES. In this example we use three zones at the ZONE start and another two zones afterwards.

On pre-defined sub-channels are transmitted the preambles specific to the ZONES used inside the SET. If potentially there are more ZONES than those used at the beginning of the FRAME, those ZONES might be scheduled in the next Frame or after ending the starting ZONES. For example, we start the DL SET with three zones, each using one of the Matrixes A,B,C. We start with the preambles, followed by MCH. The MAPs are transmitted using the suitable Matrix. Only the MCH might use a pre-known robust modulation, however due to its shortness the impact of the general overhead will be much lower.

The MCH location (sub-channel number) may be “a priori” known or may be indicated by the preamble coding. The MCH<sub>i</sub> will indicate not only those parameters essential for the decoding the MAP of ZONE I, but also the coordinates for the start of this zone and another two zones, ZONE m and ZONE n. The MCH will include:

- type of the ZONE<sub>i</sub> (containing the MAP)
- permutation used
- starting coordinates (sub-channel, nr. of consecutive sub-channels)
- modulation and coding of the Zone's MAP
- eventually the duration of the ZONE
- starting coordinates of ZCH<sub>m</sub> (the start may be in the same frame or over multiple frames);
- preamble indicator in zone m
- starting coordinates of ZCH<sub>n</sub> (the start may be in the same frame or over multiple frames);
- preamble indicator in zone n

In Fig. 17, SET 0 starts with one broadcast ZONE and two unicast Zones. The unicast Zones may indicate the start of the following zones, by the starting coordinates of the ZCH<sub>m</sub>. ZONE04 takes advantage of the fact that the Broadcast traffic is reduced when transmitting inter-frames. The MCH at the start of the frame points to another MCH within the Frame. We call this approach, exemplified inside SET0, the “linked-MCH approach”.

Alternatively, the MCH can have fixed locations inside the SET. Such an example is indicated in fig. 17 for



SET 1, SET and SET3. There are 3 MCH fixed location at the start of the DL SET1 and another 3 fixed locations around the middle of the DL SET1. This approach is called “fixed MCH approach”.

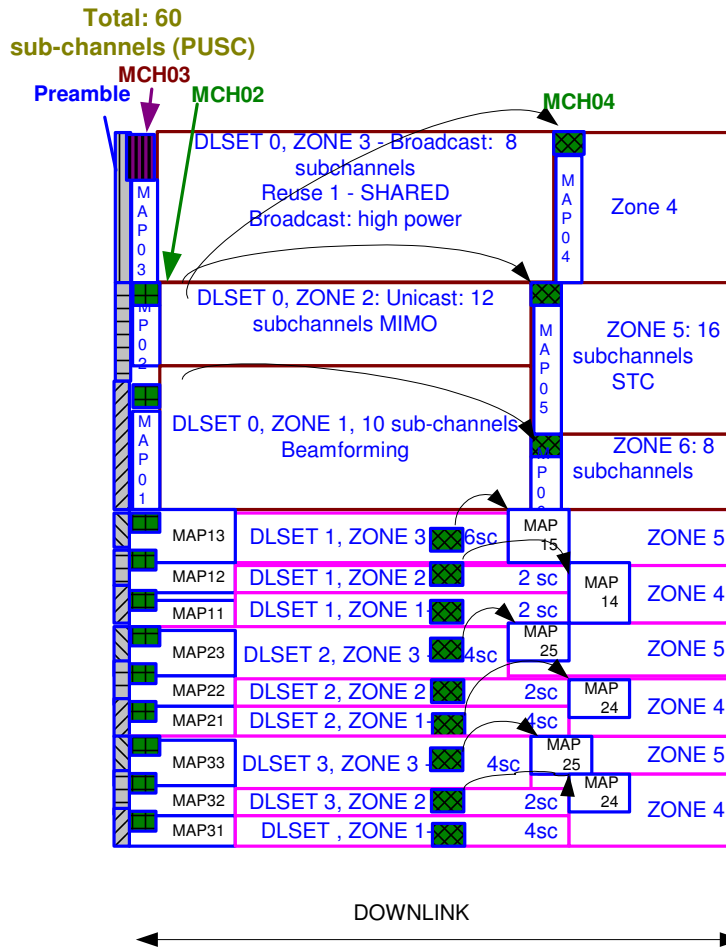

**Fig. 10 Zones within DLSET**

End text for SDD

## Legacy support

The approach most suitable is the legacy frame split in time domain, such that the legacy systems and the 16m systems will occupy different sub-frames.

A number of contributions presented in the November 802.16 session already addressed the support of legacy systems. One of the contributions presenting the split in time domain is the contribution IEEE C802.16m-07/263, by Roger Marks, Lei Wang, Yair Bourlas, Srikanth Gummadi, Kenneth Stanwood, “802.16m Frame Structure to Enable Legacy Support, Technology Evolution, and Reduced Latency”. We consider that the approach in this contribution is suitable for the implementation of the new frame structure proposed in this contribution.

## Required Actions

## **TOC**

In order to address the new frame structure in SDD, it is needed a clause related to this issue.

**We propose to add a sub-clause to the Physical Layer Chapter, named “High-level frame structure”.** This will permit to address the changes at lower level in a different clause.

## **Text in the SSD**

There are two possibilities:

1. If there are other contributions presenting the Frame Structure, **we suggest forming an Ad-Hoc for the harmonization of this proposal with other proposals related to the frame structure** in order to include in SDD a consolidated text.
2. If this contribution is accepted as it is, the Text for SDD contained between the Title “Frame type 2 – alternate frames” on page 4 and ends on page 11 before the Title “Legacy Support” on page 9.

## **Reference**

[1] Mariana Goldhamer, 802.16m basic frame structure for improved intra-system coexistence, IEEE C80216m-08\_039, Jan. 2008