

Codebook-based Opportunistic (Multiple) Beamforming for DL MIMO schemes

IEEE 802.16 Presentation Submission Template (Rev. 9)

Document Number:

IEEE C802.16m-08/451r3

Date Submitted:

2008-05-05

Source:

Wooram Shin, Choong Il Yeh, In-Kyeong Choi,
Young Seog Song, Seung Joon Lee, Byung-Jae Kwak,
Jihyung Kim, Dong Seung Kwon
ETRI
161, Gajeong-dong, Yuseong-gu, Daejeon, 305-700, Korea

E-mail: w.shin@etri.re.kr (Wooram Shin)
dskwon@etri.re.kr (Dong Seung Kwon)

Jiwon Kang, Chungyong Lee

Yonsei University

134, Sinchon-dong, Seodaemun-gu, Seoul, 120-749, Korea

E-mail: kangjw@csp.yonsei.ac.kr (Jiwon Kang)
cylee@yonsei.ac.kr (Chungyong Lee)

Venue:

IEEE 802.16m-08/016r1: Call for Contributions on Project 802.16m System Description Document (SDD) (2008-03-20),
downlink MIMO schemes.

Base Contribution:

N/A

Purpose:

For discussion and approval by TGm

Notice:

This document does not represent the agreed views of the IEEE 802.16 Working Group or any of its subgroups. It represents only the views of the participants listed in the "Source(s)" field above. It is offered as a basis for discussion. It is not binding on the contributor(s), who reserve(s) the right to add, amend or withdraw material contained herein.

Release:

The contributor grants a free, irrevocable license to the IEEE to incorporate material contained in this contribution, and any modifications thereof, in the creation of an IEEE Standards publication; to copyright in the IEEE's name any IEEE Standards publication even though it may include portions of this contribution; and at the IEEE's sole discretion to permit others to reproduce in whole or in part the resulting IEEE Standards publication. The contributor also acknowledges and accepts that this contribution may be made public by IEEE 802.16.

Patent Policy:

The contributor is familiar with the IEEE-SA Patent Policy and Procedures:

<<http://standards.ieee.org/guides/bylaws/sect6-7.html#6>> and <<http://standards.ieee.org/guides/opman/sect6.html#6.3>>.

Further information is located at <<http://standards.ieee.org/board/pat/pat-material.html>> and <<http://standards.ieee.org/board/pat>>.

Introduction

- One of the most attractive DL MIMO for supporting multiple users
 - MU-MIMO exploiting *multiuser diversity*
- Channel knowledge for DL MU-MIMO at the BS
 - *Partial feedback vs. full feedback*
- More practically favorable type of feedback
 - Partial feedback (CQI, codebook index) for low-overhead and simplicity
- Proposal: Consider use of *Codebook-based Opportunistic (Multiple) BeamForming* (COBF/COMBF) with partial feedback for DL MIMO schemes

COBF

- Estimate the DL channel with N_T pilots
- Find the best codeword for each user for given a random unitary matrix and a quantized codebook
 - Random unitary matrix for OBF effect
 - Quantized codebook for selection diversity
- For each user, feed back the selected codeword and the corresponding CQI (e.g., channel gain or SINR)

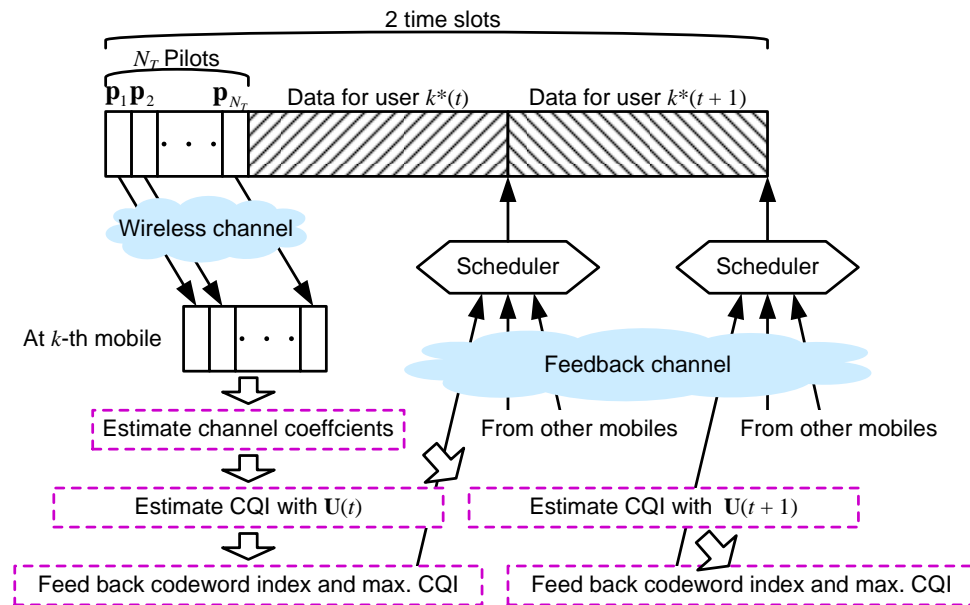

COBF

- At the BS, select the best user and its codeword based on the CQI feedback and the scheduling algorithm

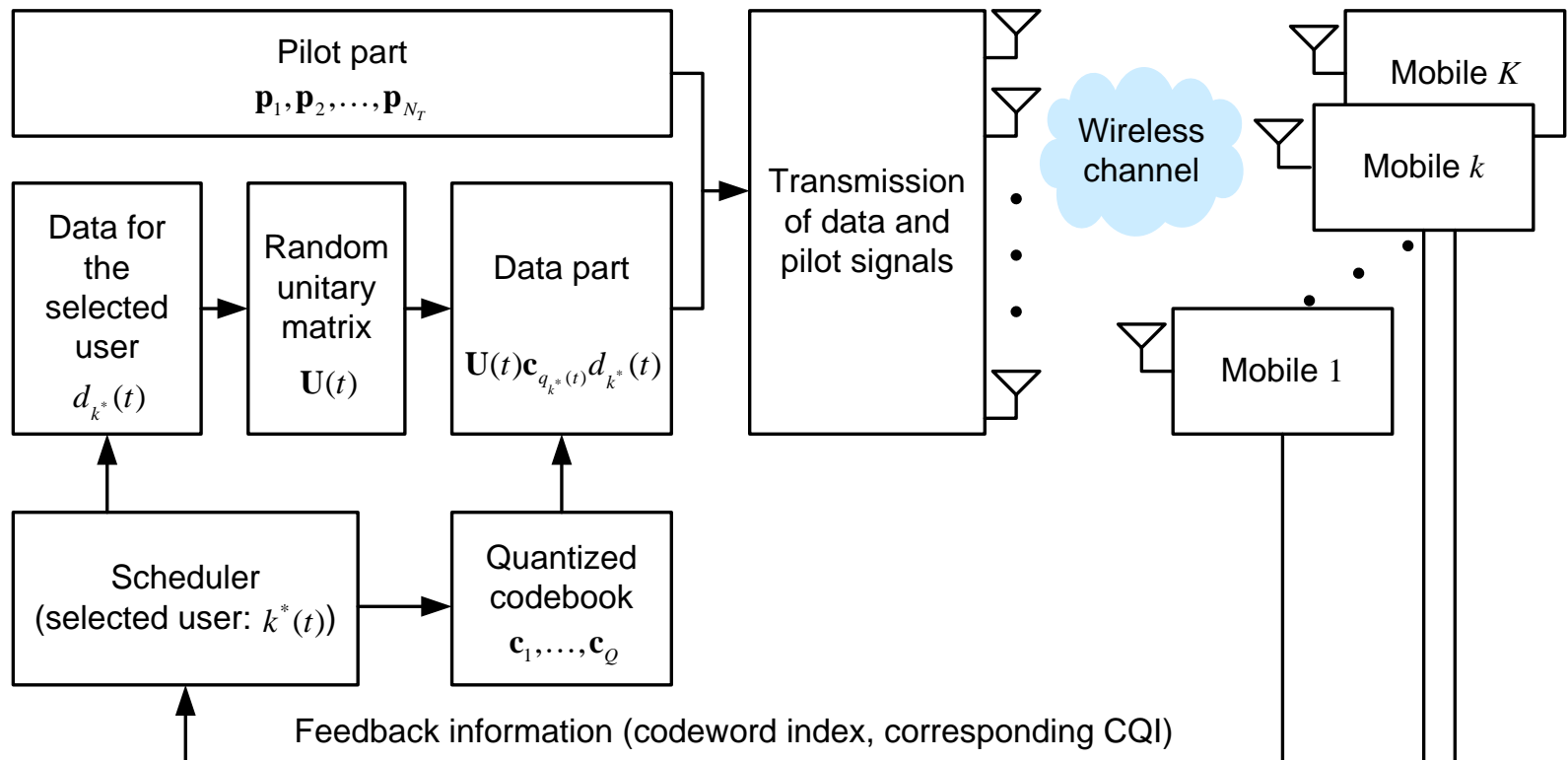

Performance Comparison

- Simulation Assumptions
 - Number of transmit antennas: 4
 - Number of receive antennas for each mobile: 1
 - Codebook: 3-bit DFT-like codebook
 - Mobility: 1km/h
 - Scheduling: PF
 - Comparison with fixed BF, OBF, Multiple-pilot-based OBF (MOBF), quantized codebook

Performance Comparison (Cont'd)

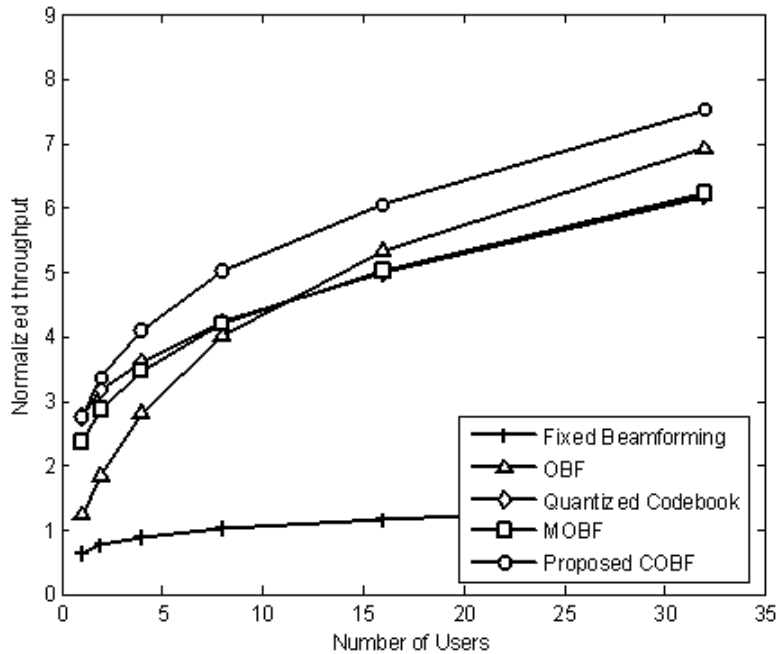

(a) High spatial correlation

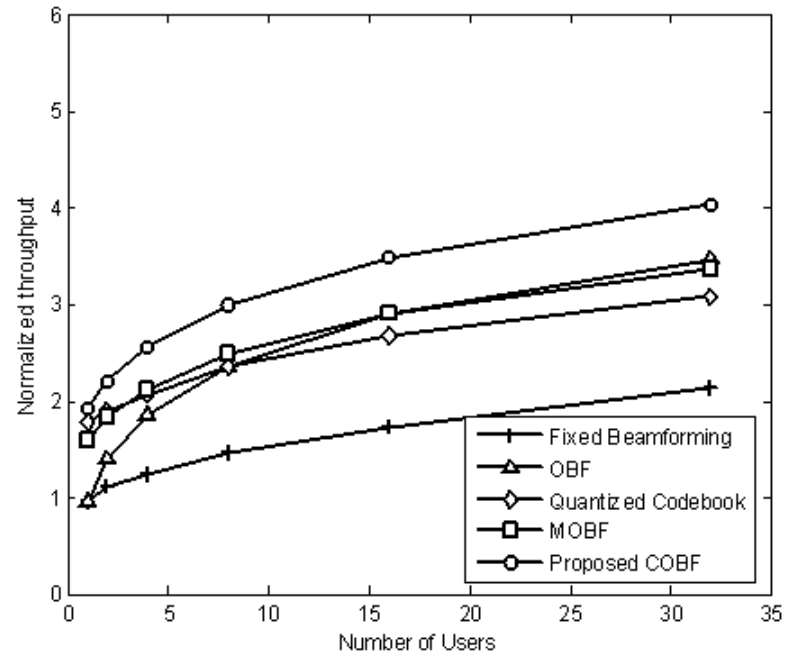

(b) Low spatial correlation

- COBF superior to the others in all corr. scenarios
- Performance gain larger at high corr.

COMBF

- Extension of COBF to multiple beamforming
- Group users based on the codeword feedback
 - Users in the same group have the same codeword
- Select the best user with the largest CQI for each stream in each group
- Calculate sum-capacity for each group and select the best group with the largest capacity and its codeword

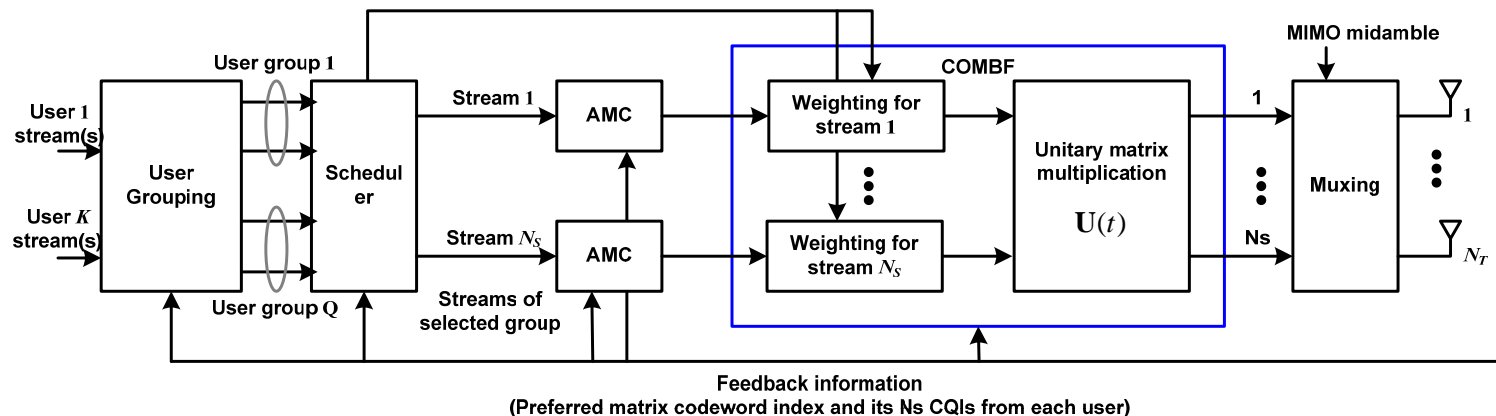

Performance Comparison

- Simulation Assumptions

- Number of transmit antennas: 4
- Number of receive antennas for each mobile: 2
- Sampling frequency: 10 MHz (FFT size: 1024)
- Effective number of subcarriers: 864
- Frame length: 5 ms, number of DL symbols: 24
- Number of subcarriers per subchannel: 48
- Subchannelization: AMC 2 bin x 3 symbol
- Mobility: 1km/h, Scheduling: PF per band
- Codebook: 3-bit codebook in IEEE 802.16e
- Goodput comparison with *Codebook-based Multiple BeamForming (CMBF)* (R1-0603353, 3GPP TSG RAN WG1 Meeting #44, Denver, USA, 13 – 17 February, 2006, “Downlink MIMO for EUTRA”)

Performance Comparison (Cont'd)

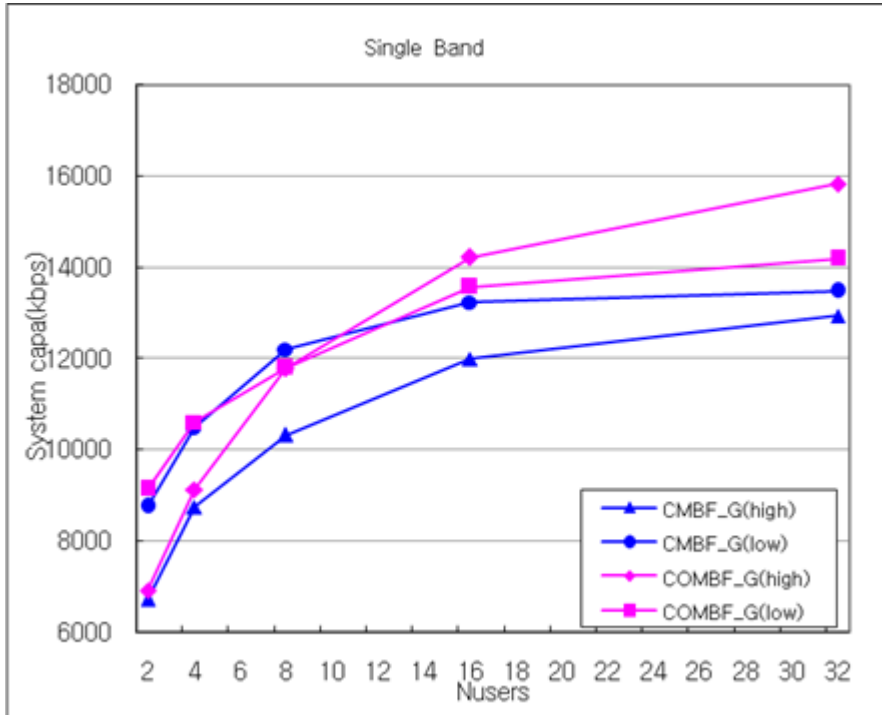

(a) Single-band

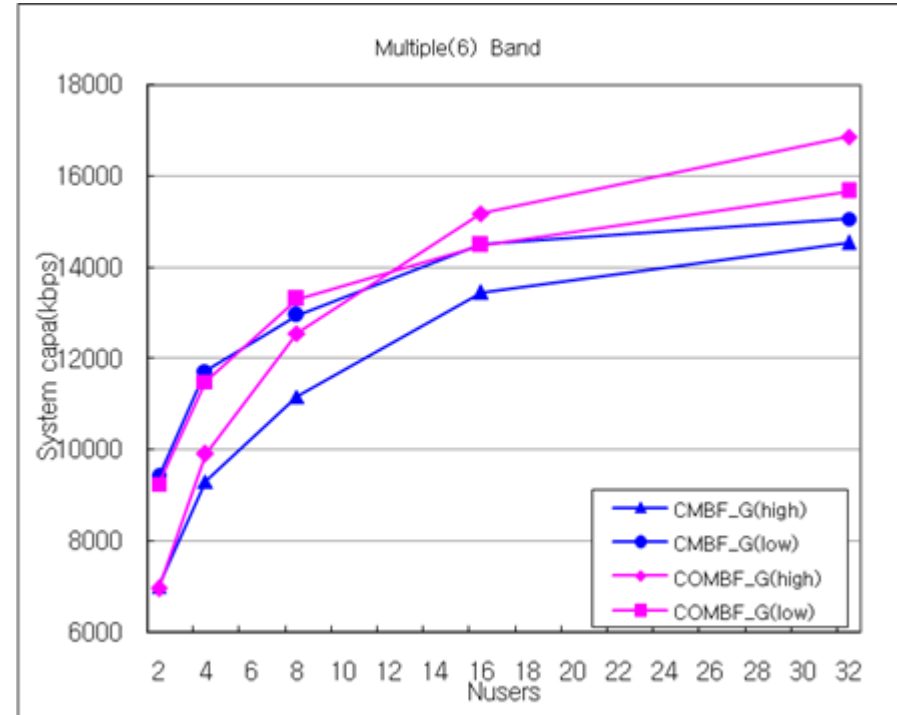

(b) Multi-band

- COMBF better than CMBF at high spatial corr.
- For small # users, better performance at low corr. (COMBF)
- Better performance with multi-band

Proposed Text for SDD

11.x. DL MIMO Schemes

11.x.y. Multiuser MIMO

Use of codebook-based opportunistic (multiple) beamforming with partial feedback shall be considered in order to exploit multiuser diversity.