

End user perspective on 400Gb/s Ethernet

Ariën Vijn
arien.vijn@ams-ix.net

Agenda

- Introduction
- AMS-IX network
 - 100GE take up
 - Future projections

Agenda

- Requirements for 400Gb/s Ethernet
- Fibre type and view on parallel fibre
 - Lengths
 - Link aggregation
 - Costs compared to existing technologies

Agenda

- Introduction
- AMS-IX network
 - 100GE take up
 - Future projections

Introduction

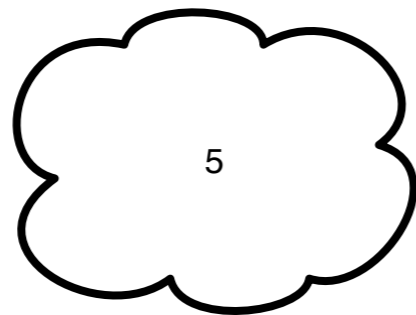
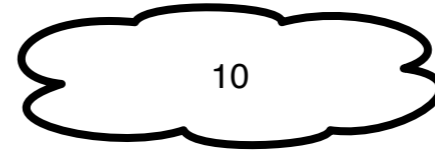
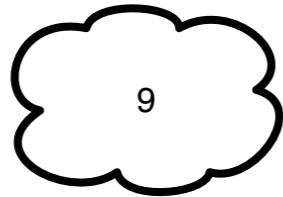

Introduction

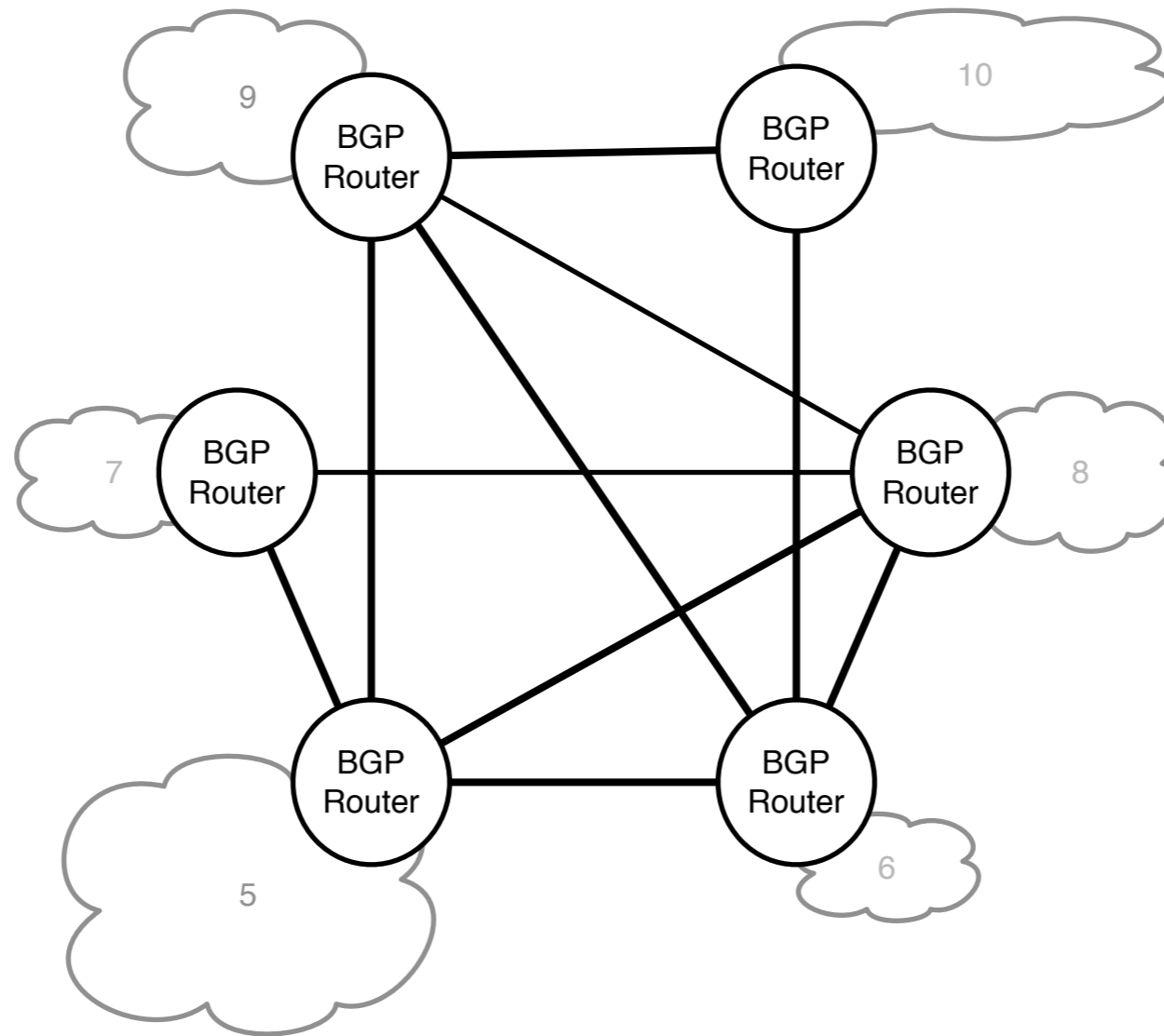

Introduction

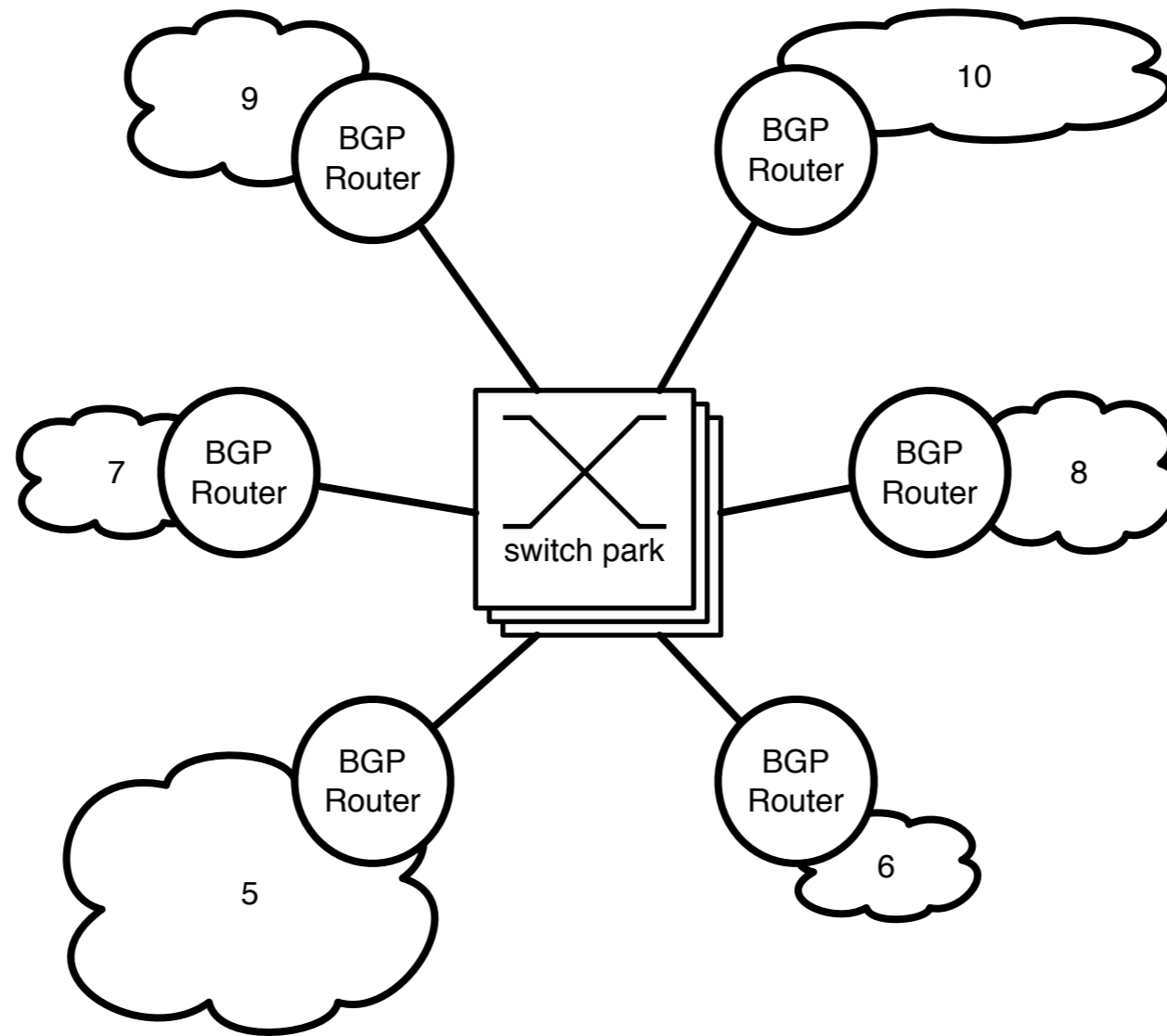

Introduction

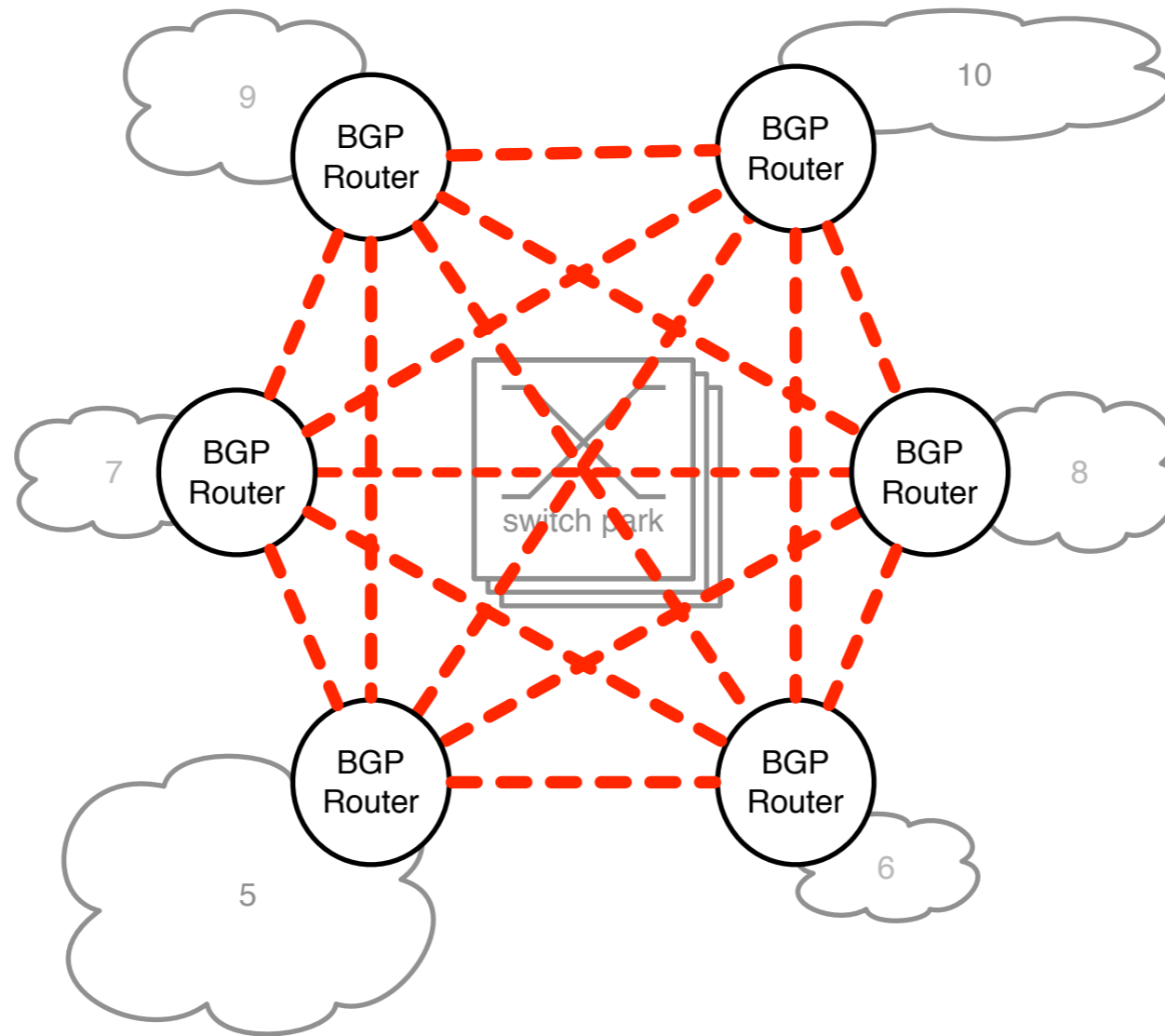

Introduction

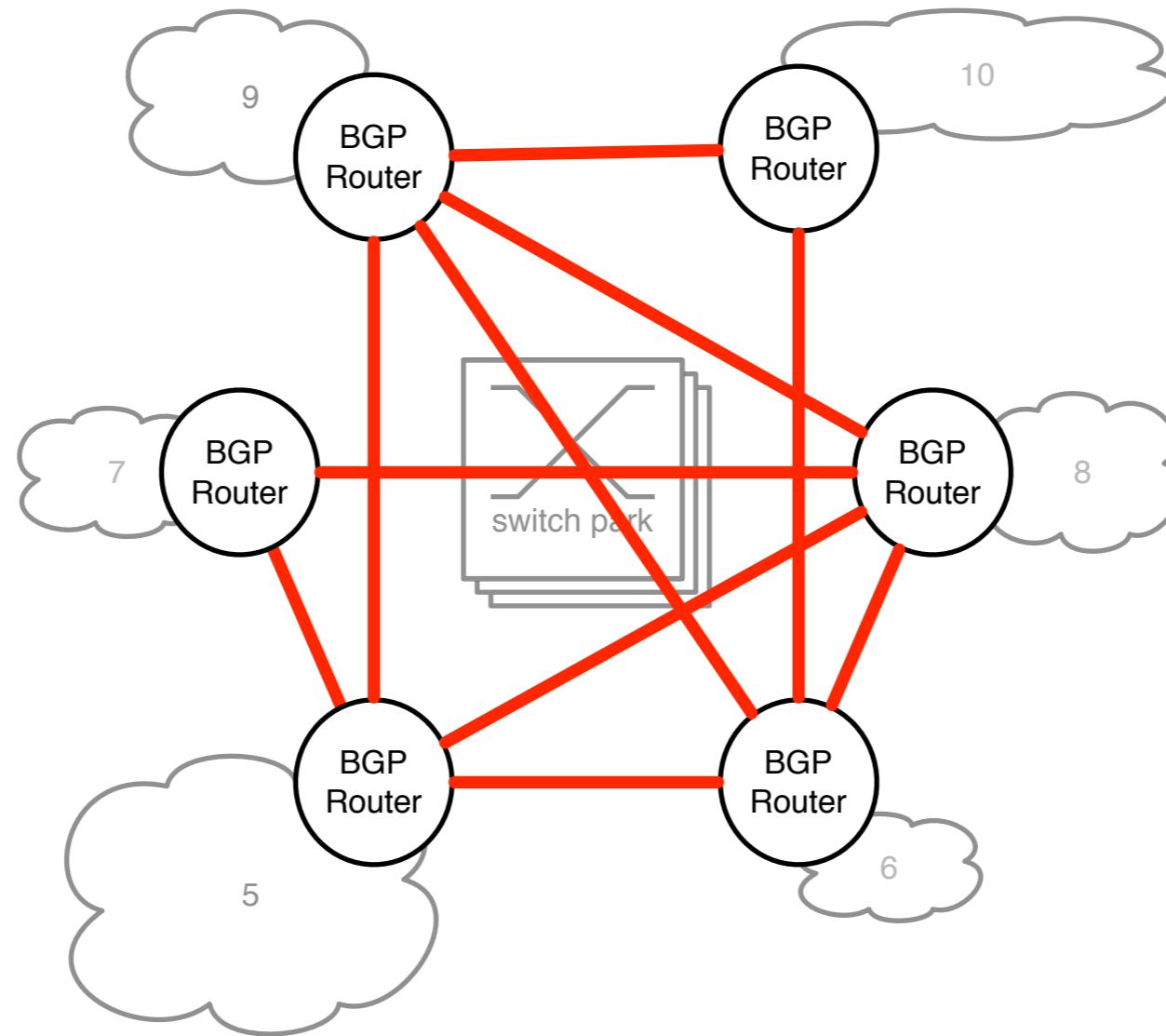

Introduction

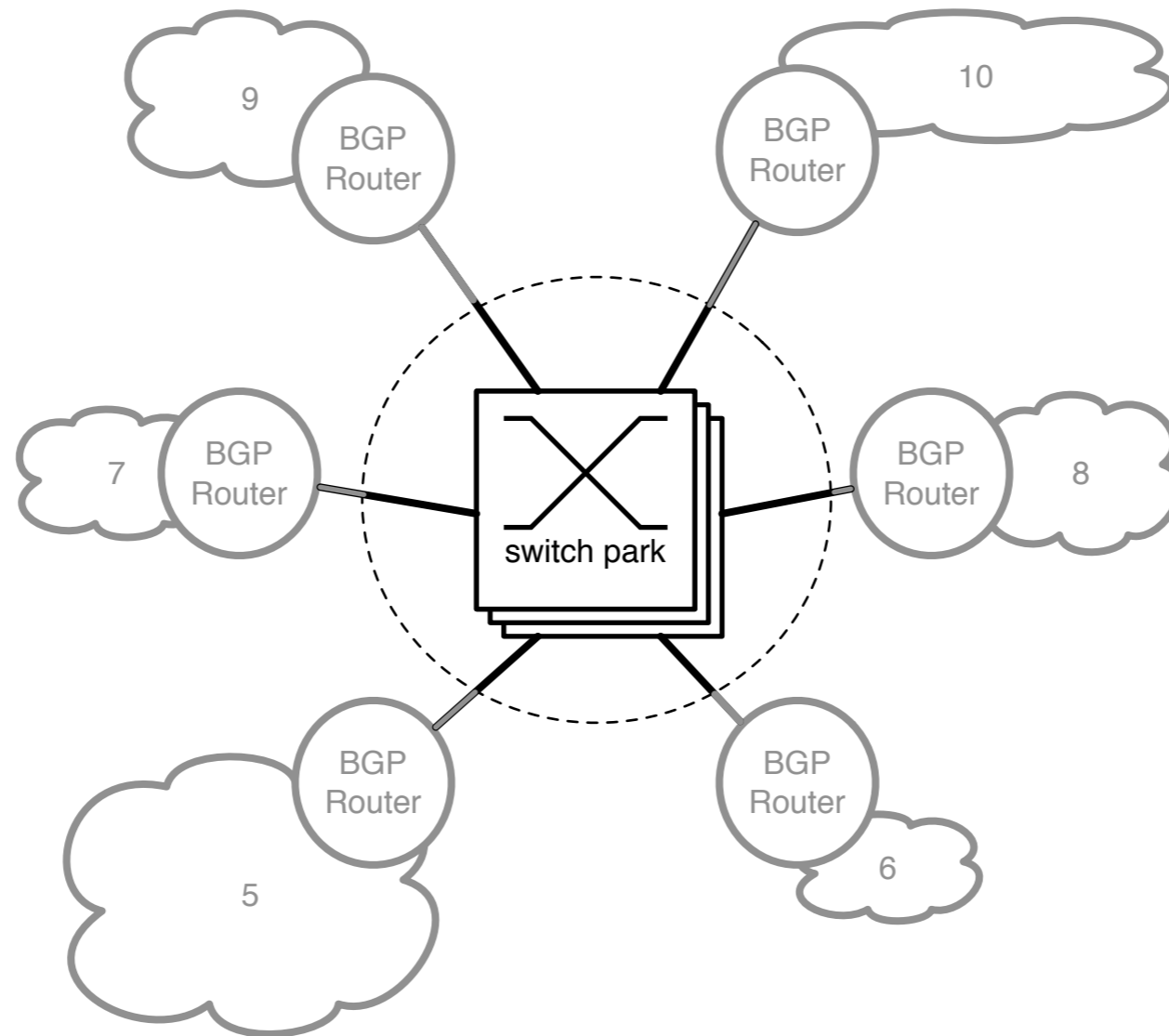

Agenda

- Introduction
- **AMS-IX network**
 - 100GE take up
 - Future projections

```

Stockholm      CERN
!              !
!512           !512
!              !
!      !-----!-----!
!      !   IDNX   !
!      !-!-----!-!
!              !
!      !448  !32
!      !IP   !CLNP
!              !
!-----!-----!-----!-----! 64
!      (ibr-router)  ----- RedIRIS
!              !
!      Amsterdam.  ----- Leuven
!      ebone.net   ! 64           !-----! (UCD)
!              ----- PTT Telecom ----- IXI (ULB)
!-----!-----!           !-----! (YUNAC)
!
=====!=====!=====!===== ibr-lan
!              !
!-----!-----!      !-----!-----!
!Amsterdam1.!      !Amsterdam. !
!router.      !      !nl.eu.net !
!surfnnet.nl !      !           !
!-----!-----!      !-----!-----!
!              !
SURFnet      EUnet

```

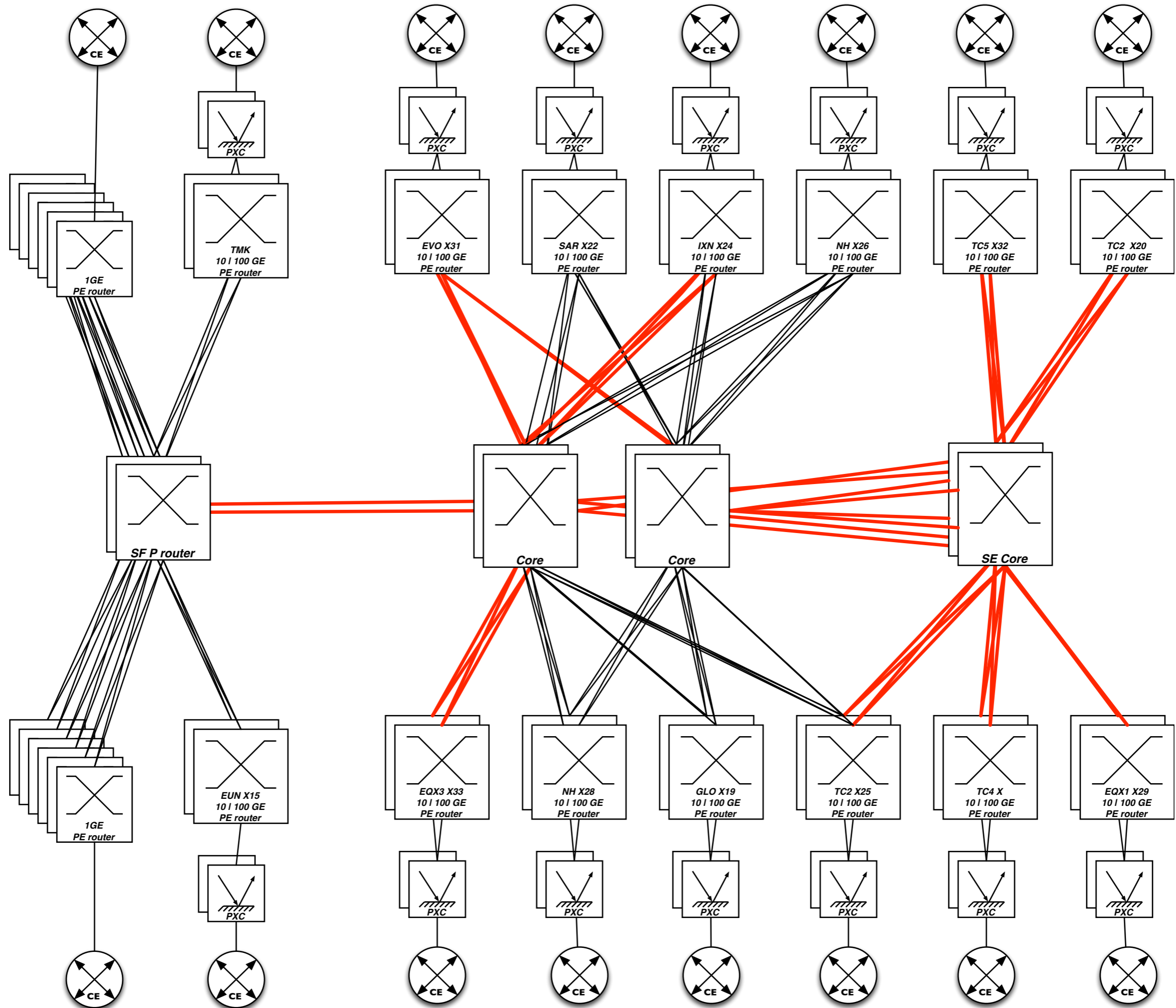

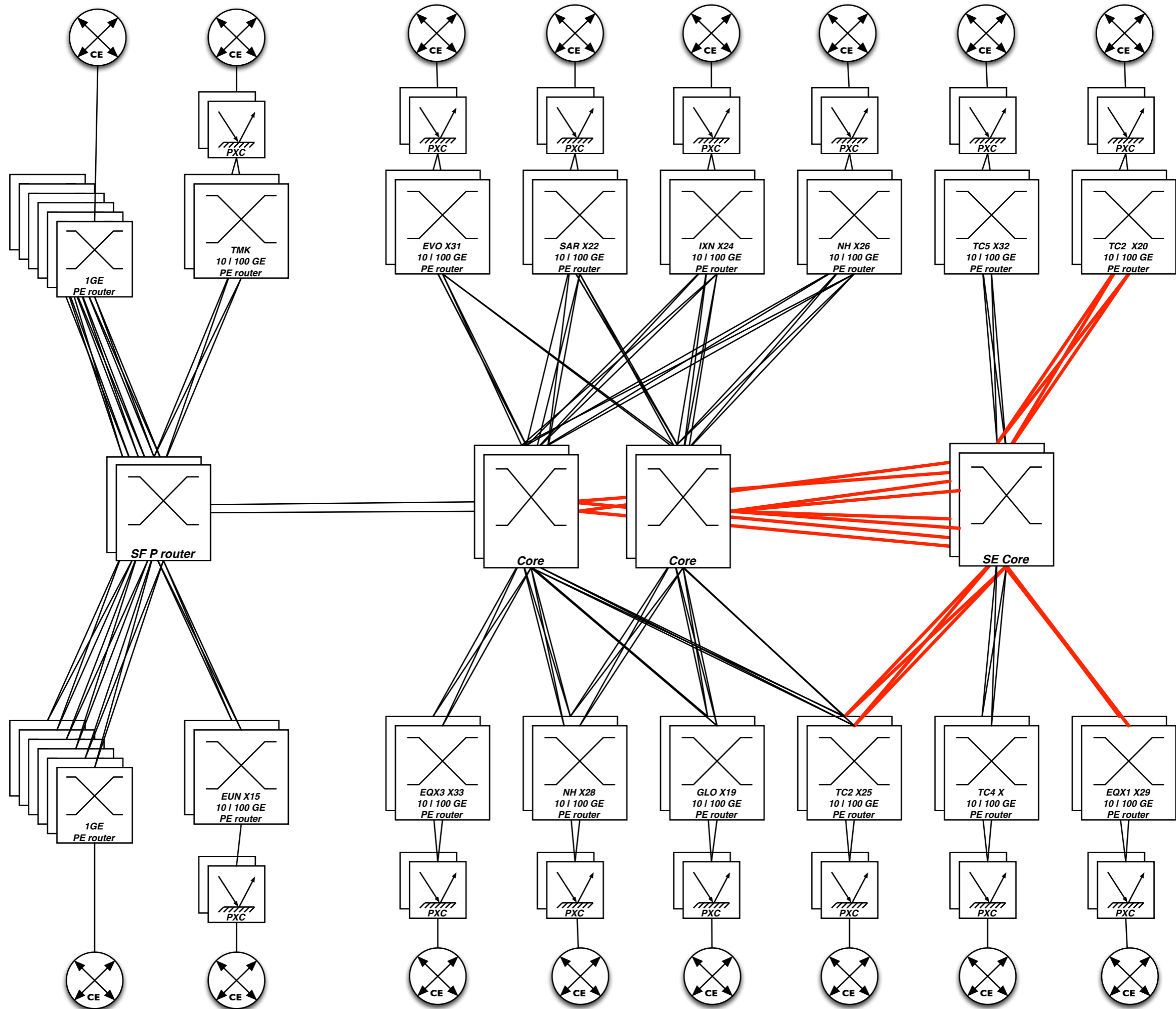

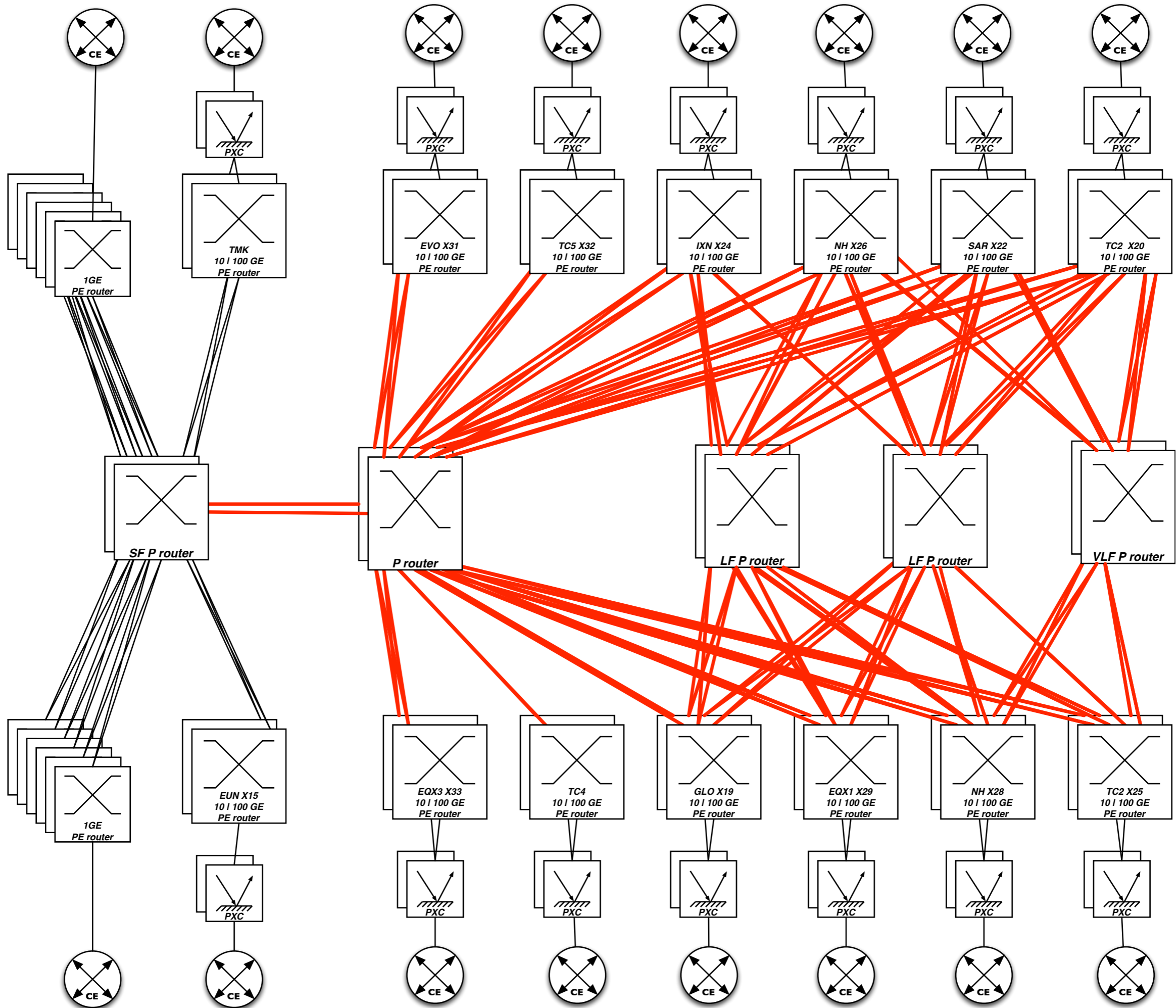

Traffic Volume Tbyte/day

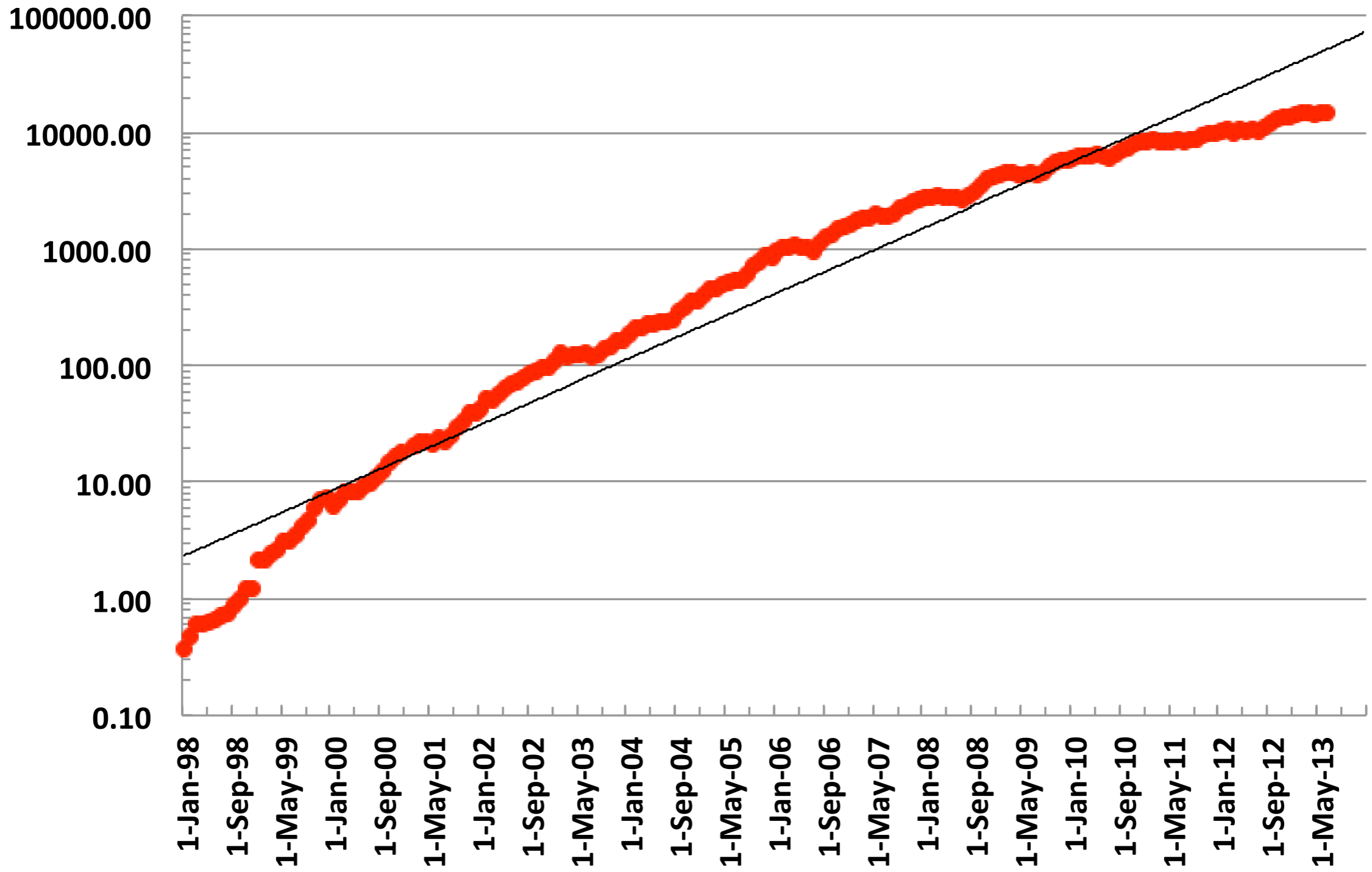

Traffic Volume Tbyte/day

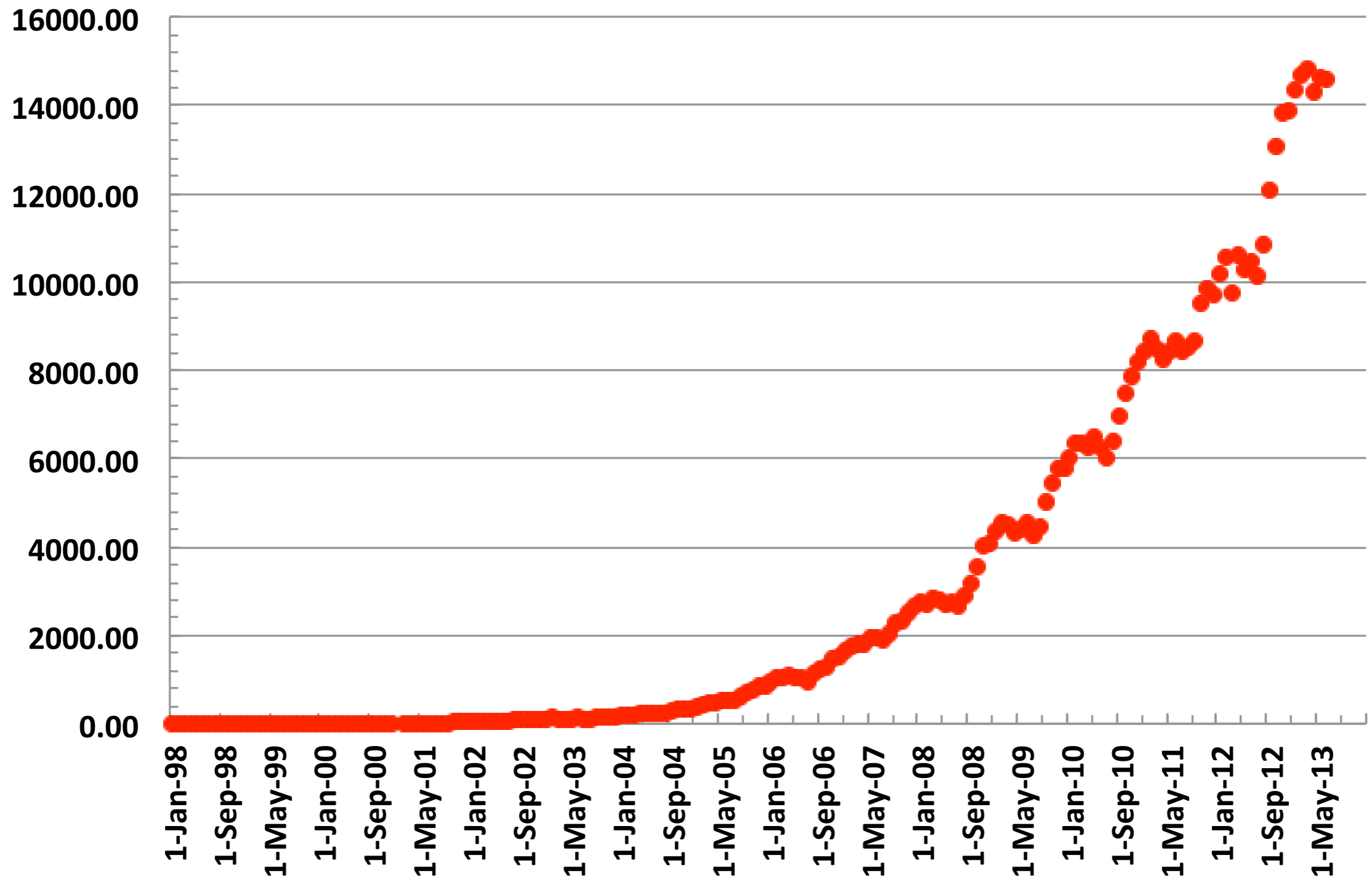

Yearly Volume Growth and YoY percentual growth

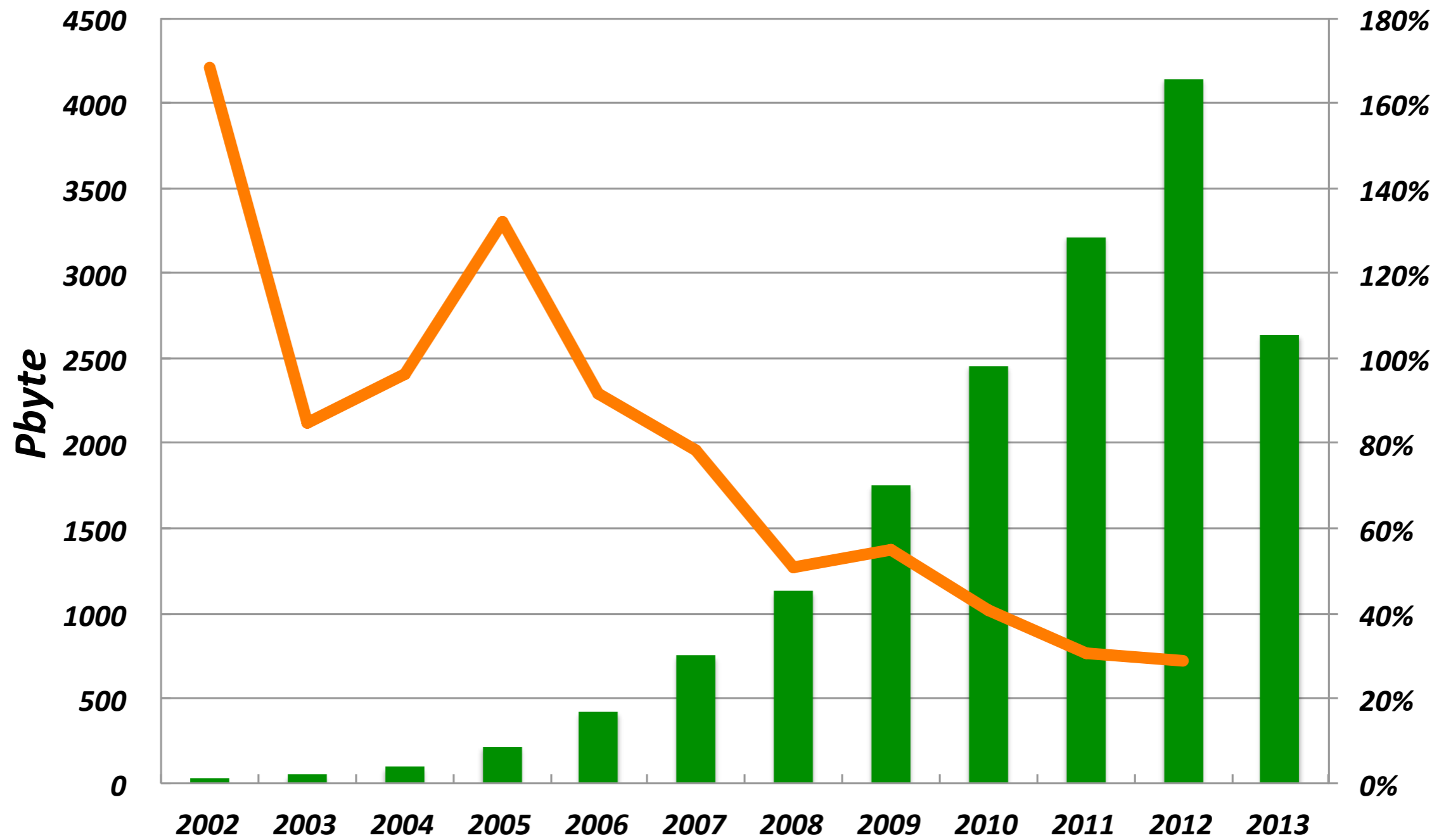

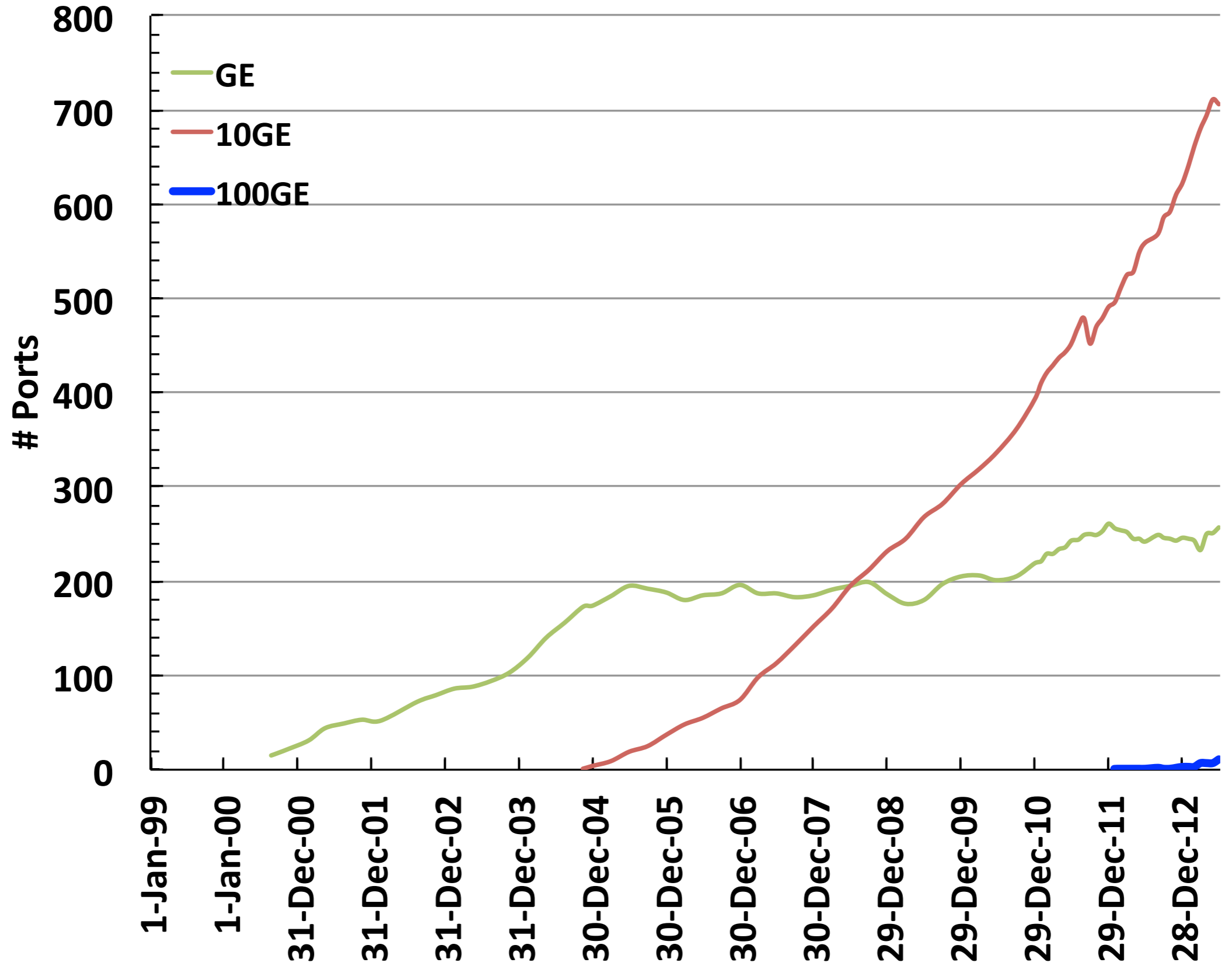

Historic and predicted Customer ports

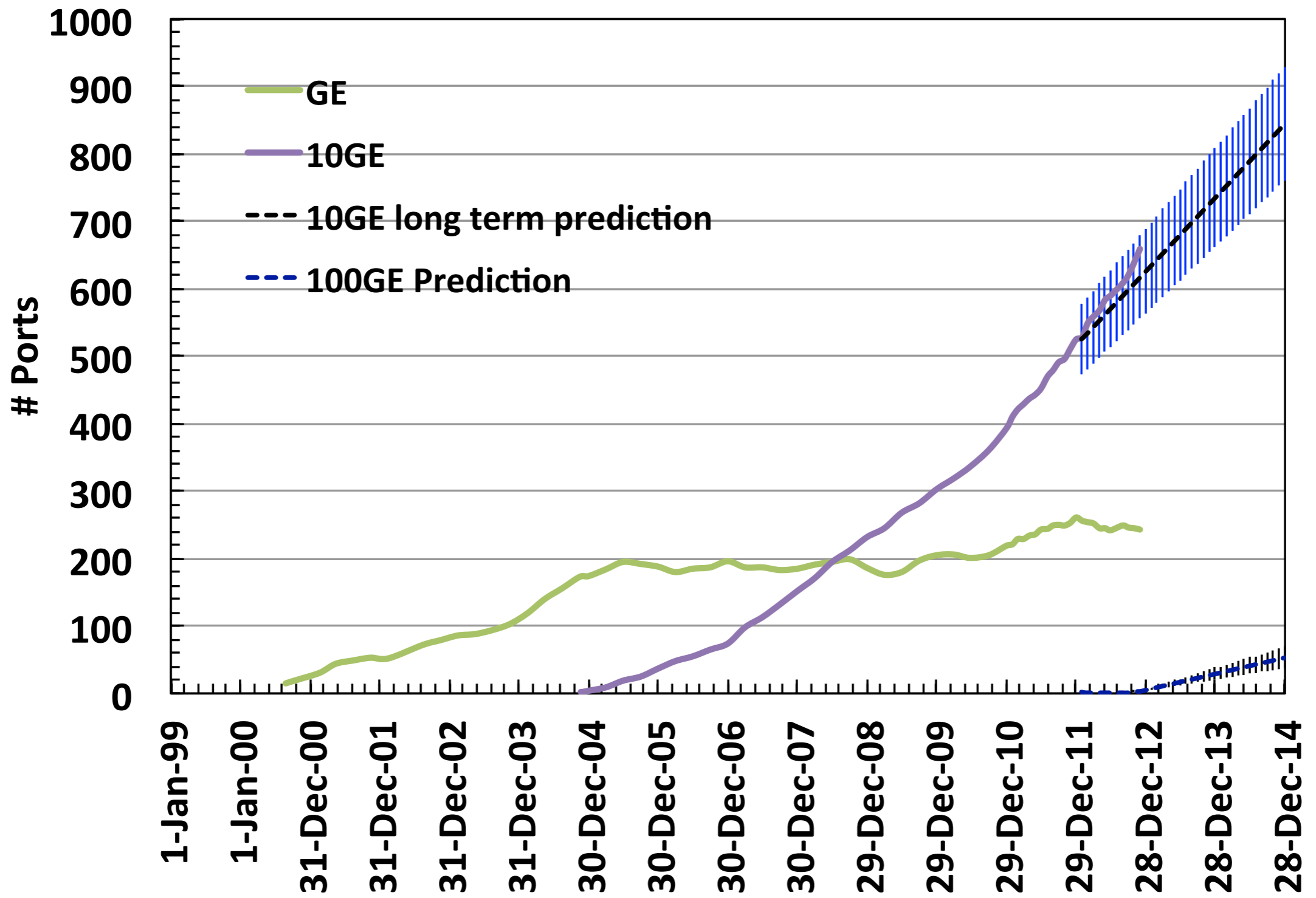

Agenda

- Requirements for 400Gb/s Ethernet
 - Fibre type and view on parallel fibre
 - Link aggregation
 - Costs compared to existing technology

Cabling

- Duplex single mode fibre
 - Don't bother about multi mode
- Fibre lengths
 - Up to 40km, direct or with low costs amplifiers or transmission equipment

Cabling

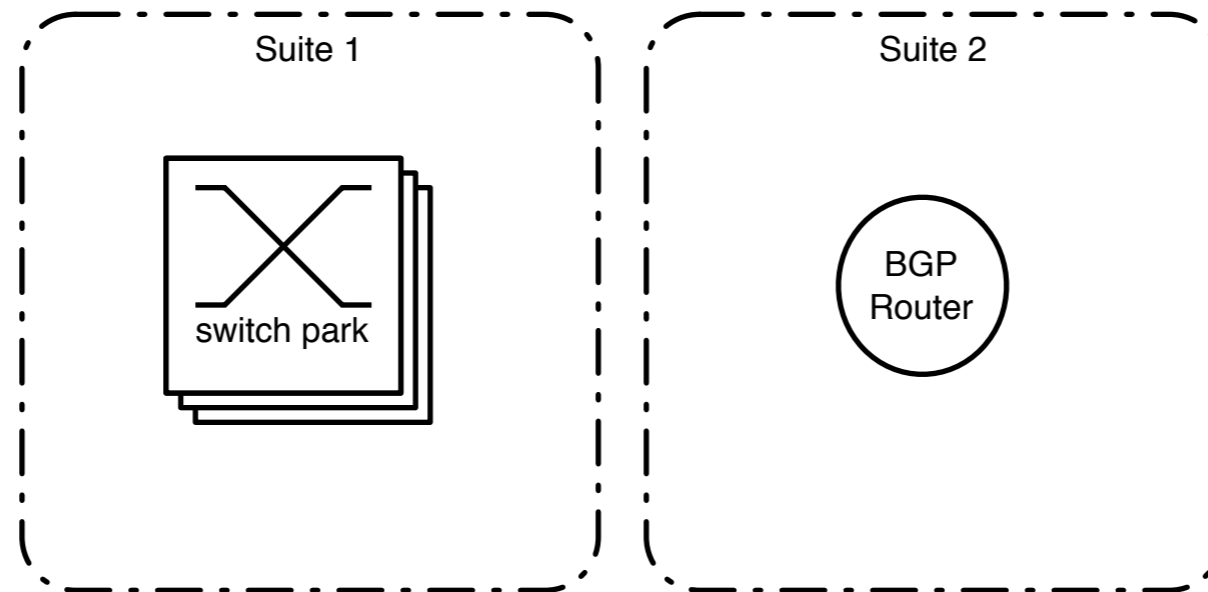

Cabling

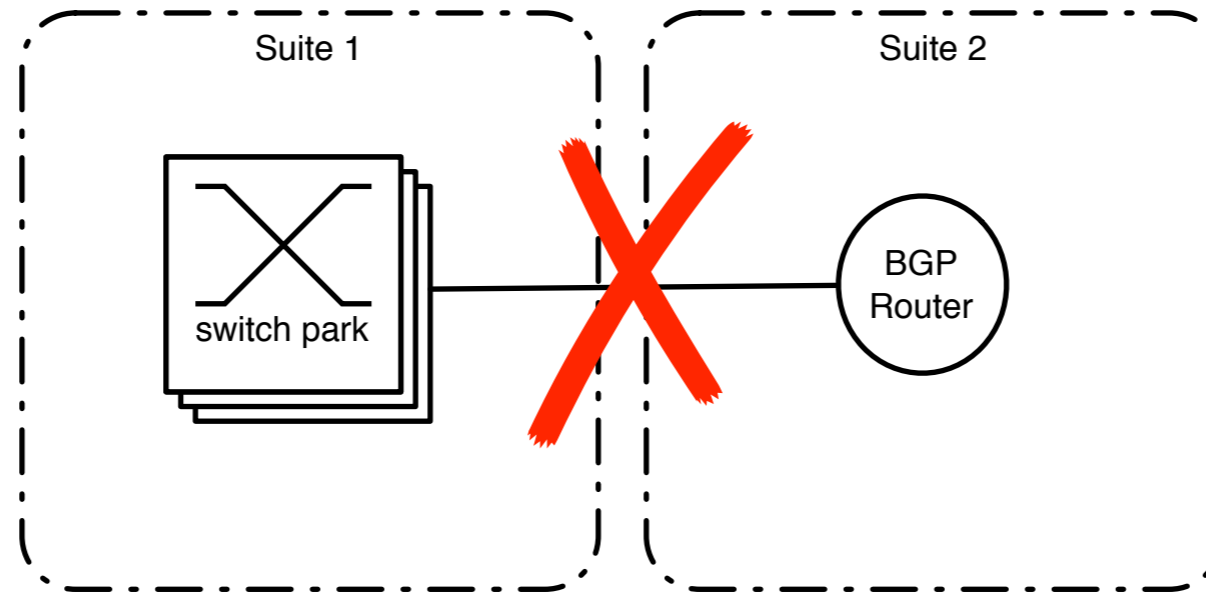

Cabling

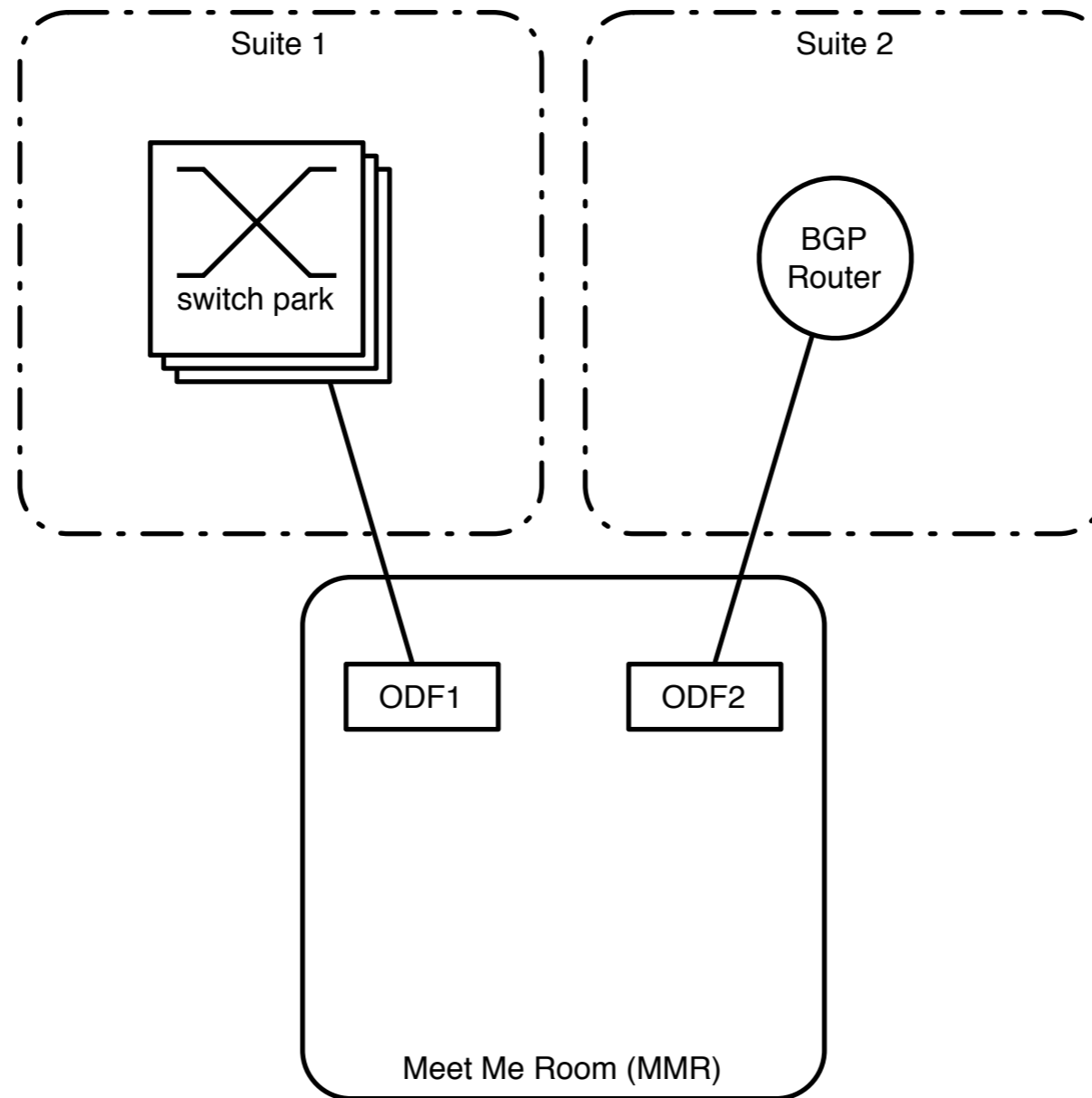

Cabling

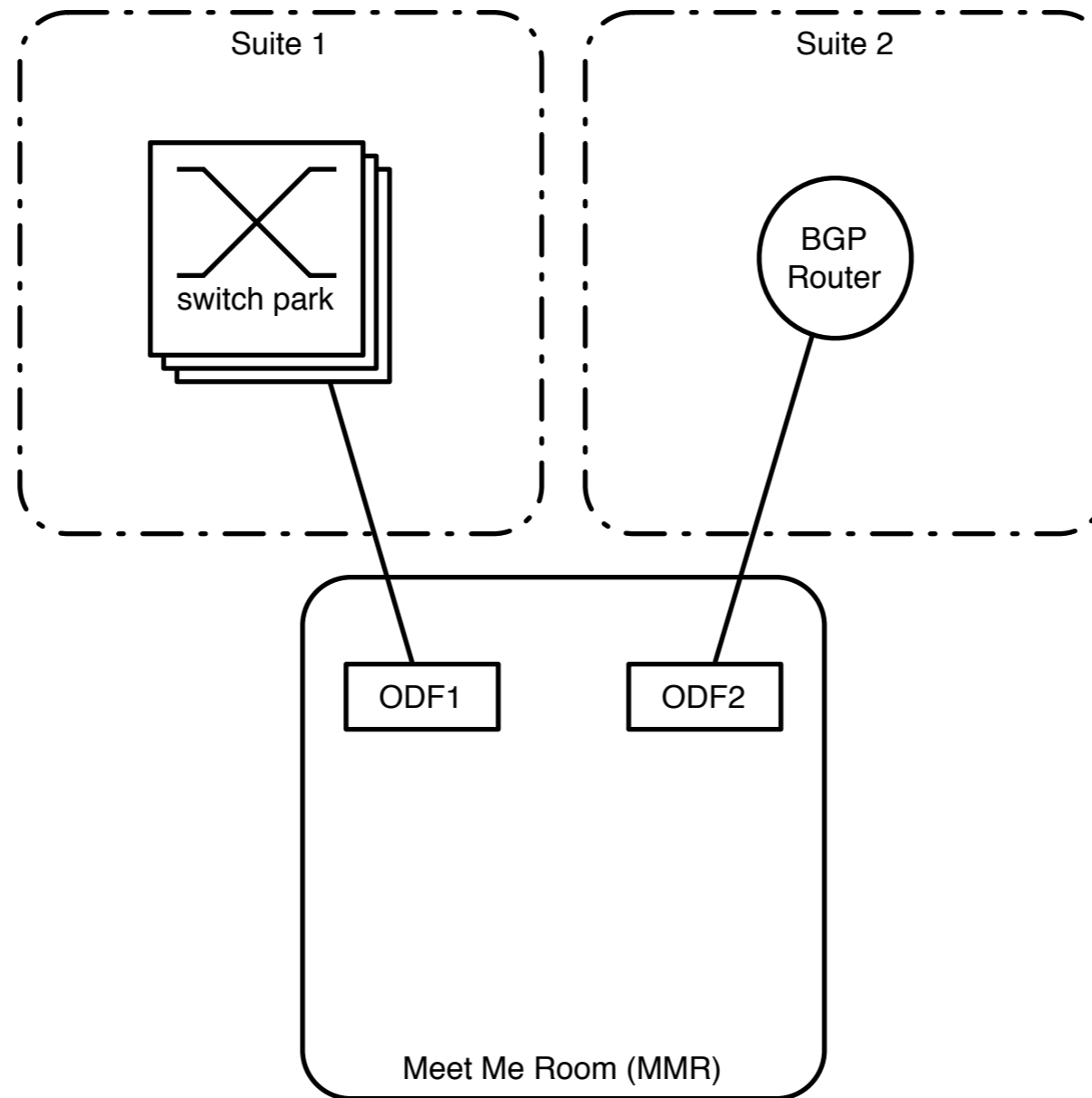

Cabling

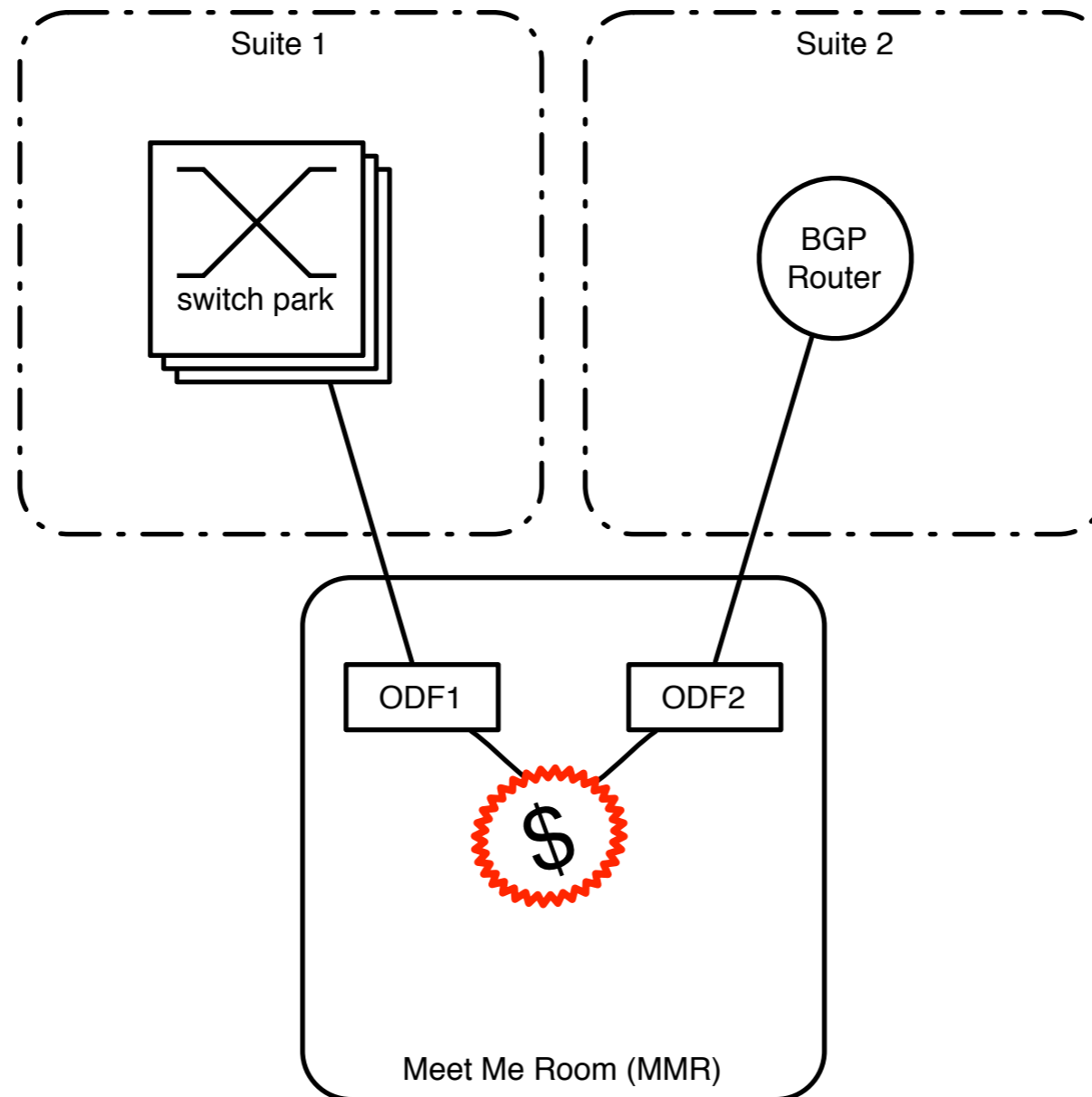

Cabling

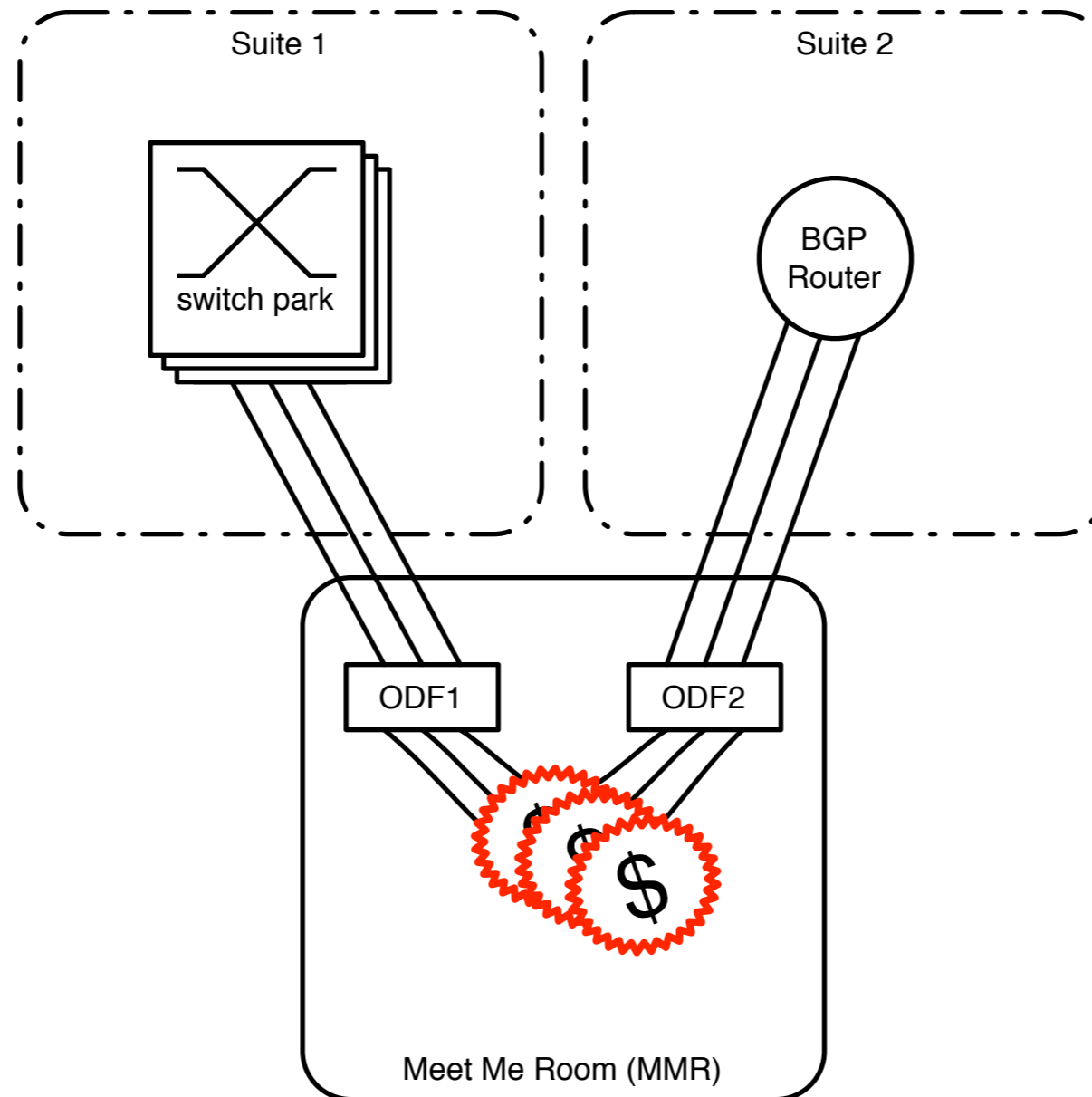

Meet Me Room

- Very high density ODFs
 - > 2000 simplex fibers in 47U
- Fusion spliced to infrastructure cabling
 - One MTP/MPO connector will take one standard splice box of 12 splices

Layer 1 switching

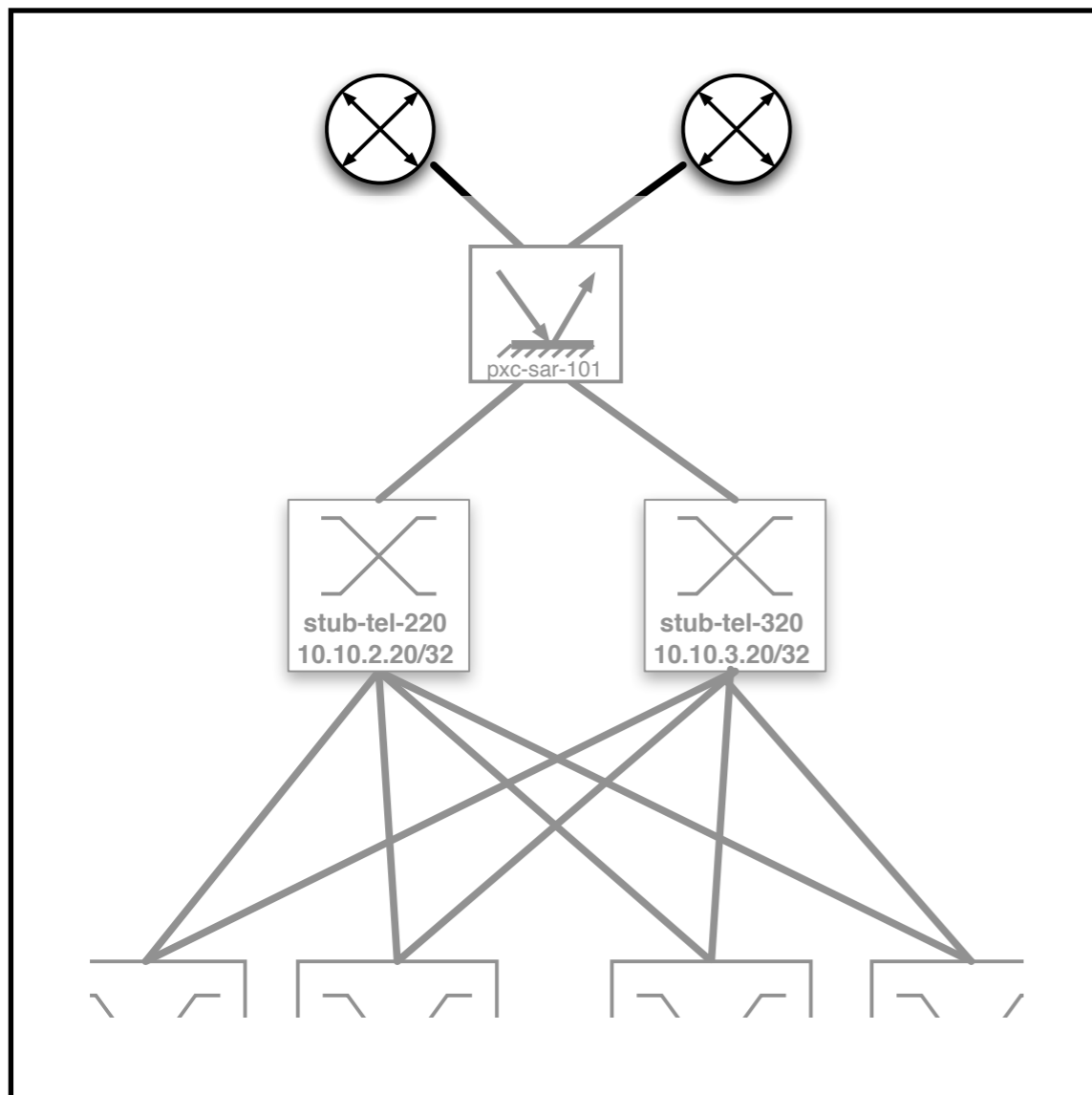

- Border routers of members



Layer 1 switching

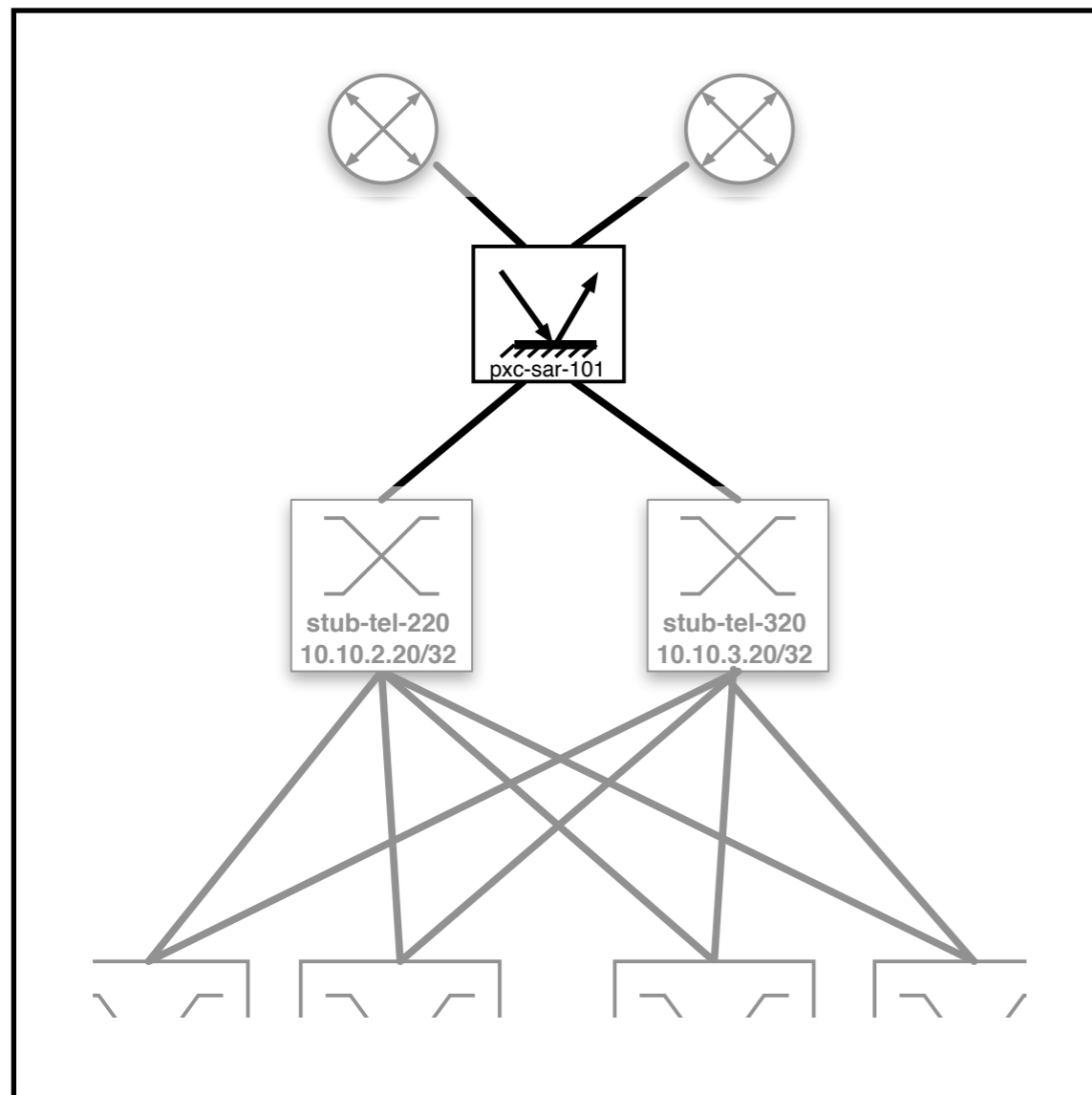

- Border routers of members
- Photonic Cross Connect (PXC)
 - Layer 1
 - Low energy consumption
 - Reliable

Layer 1 switching

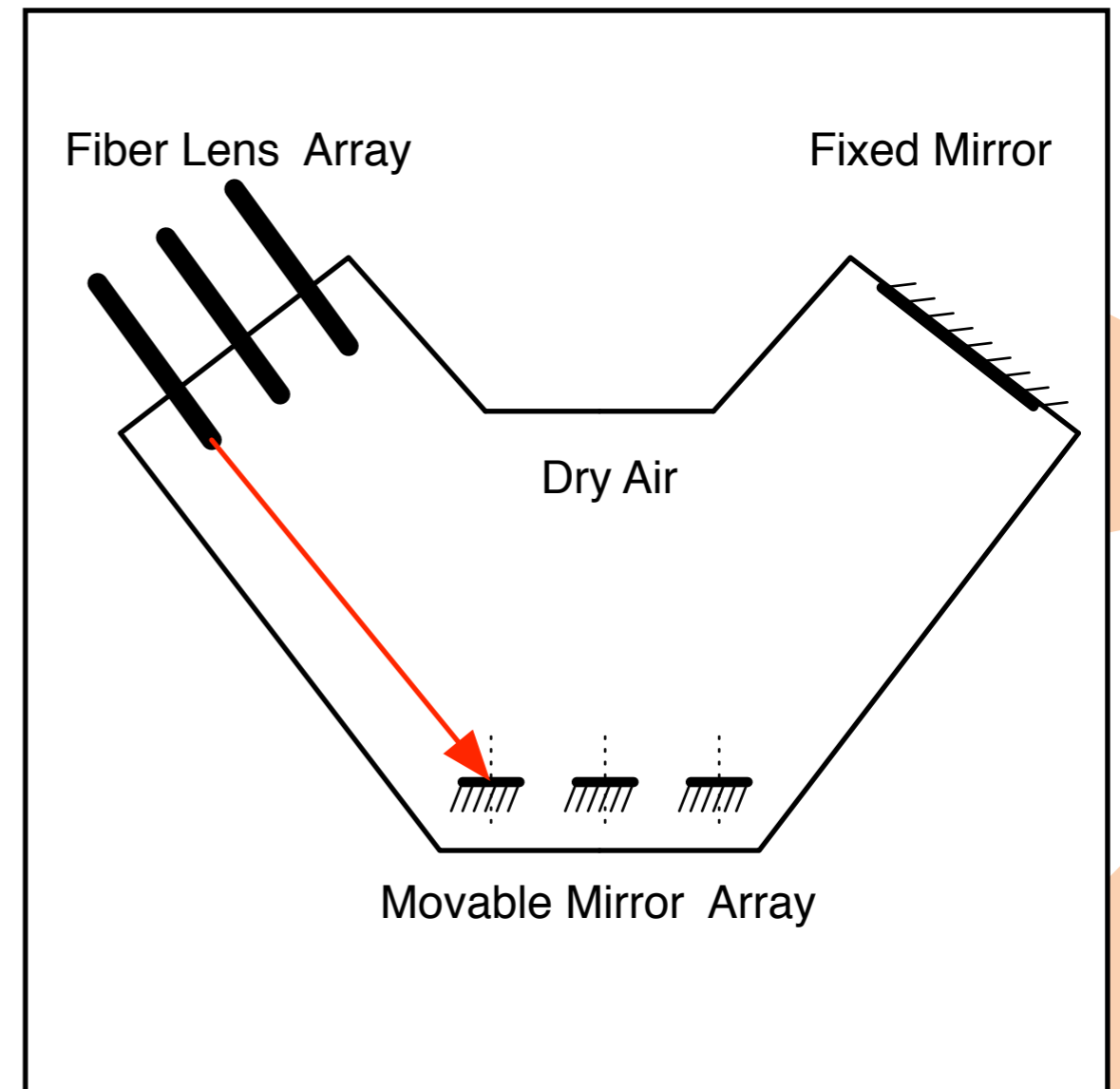
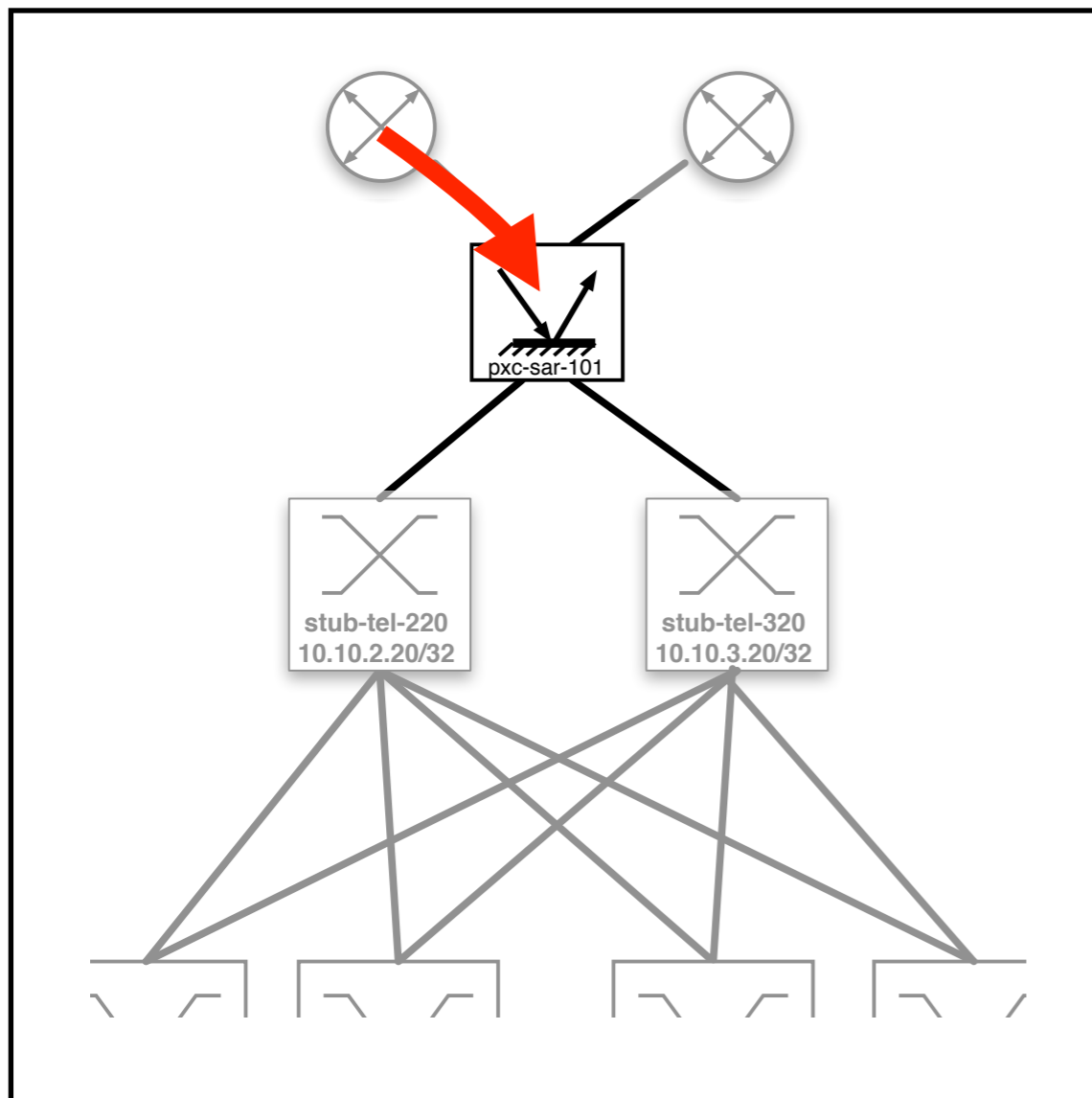

Layer 1 switching

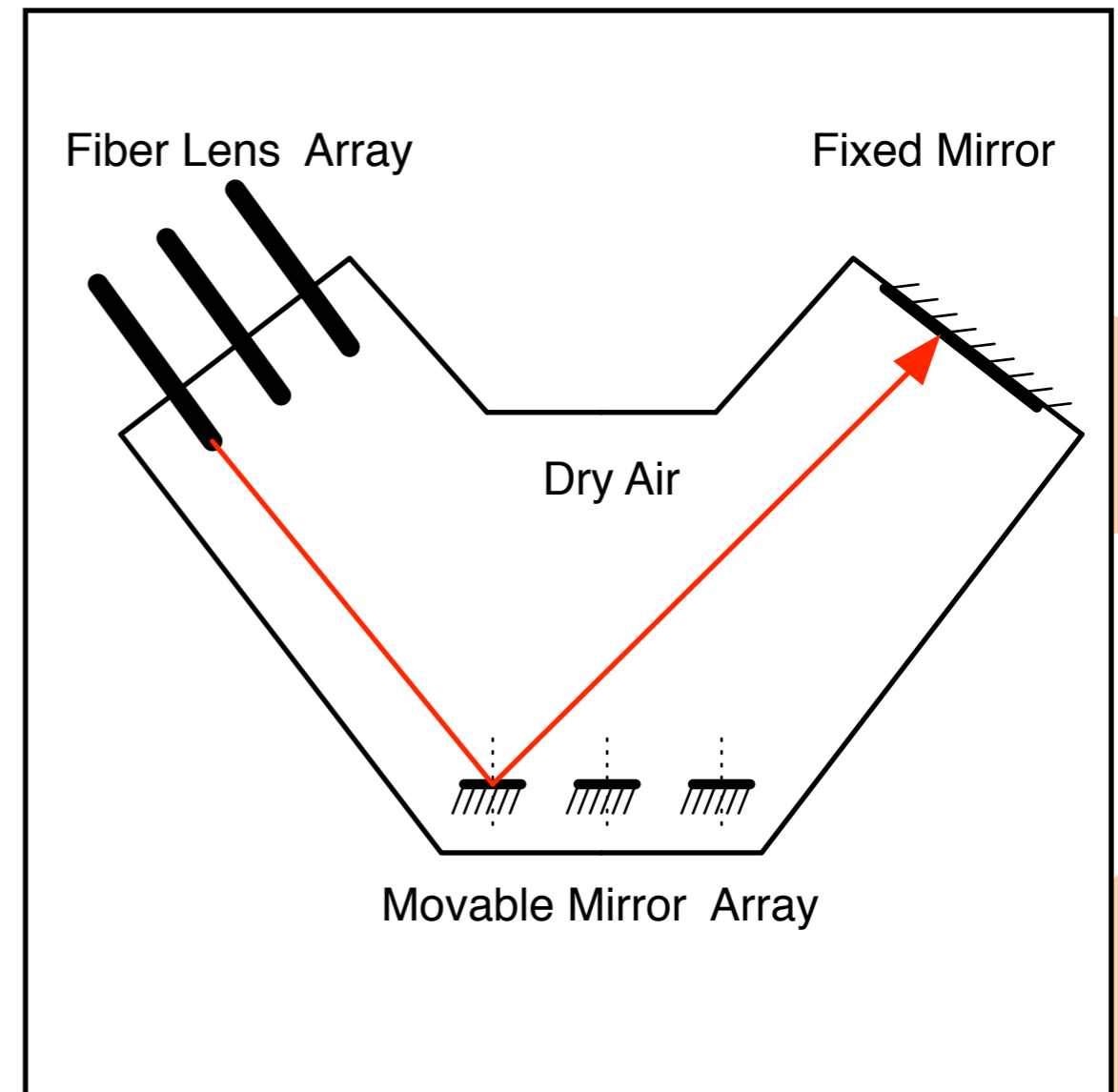
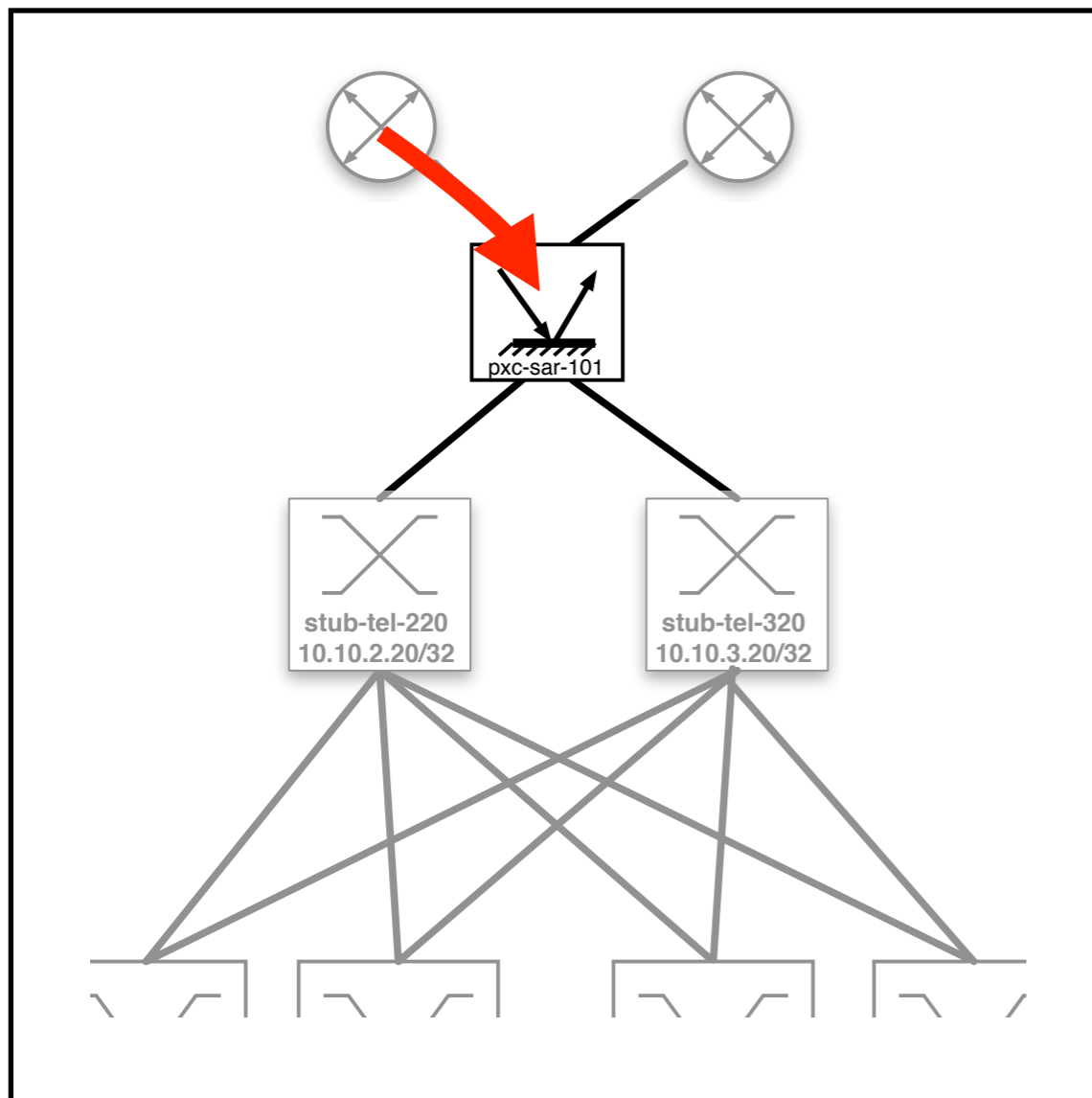

Layer 1 switching

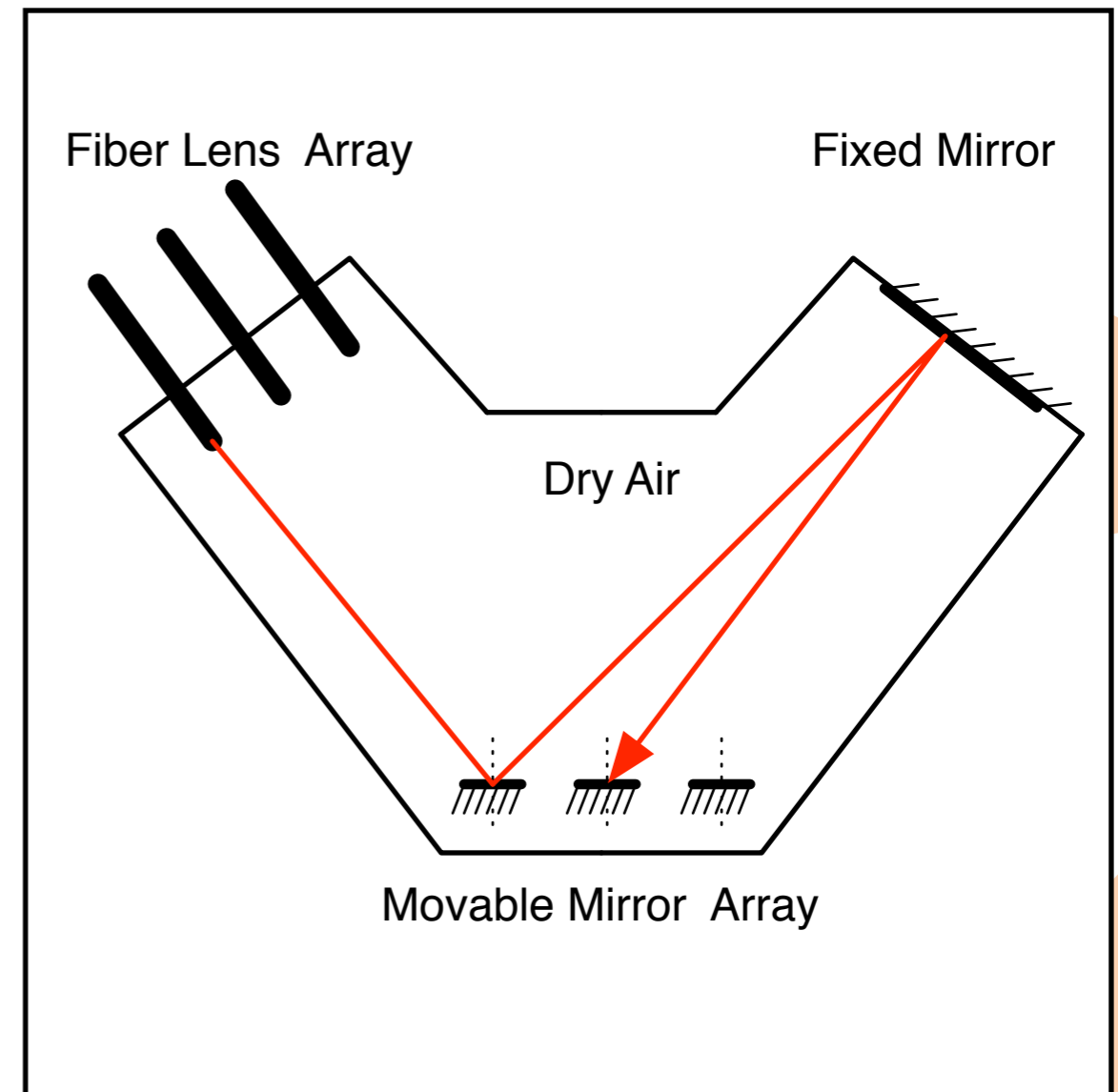
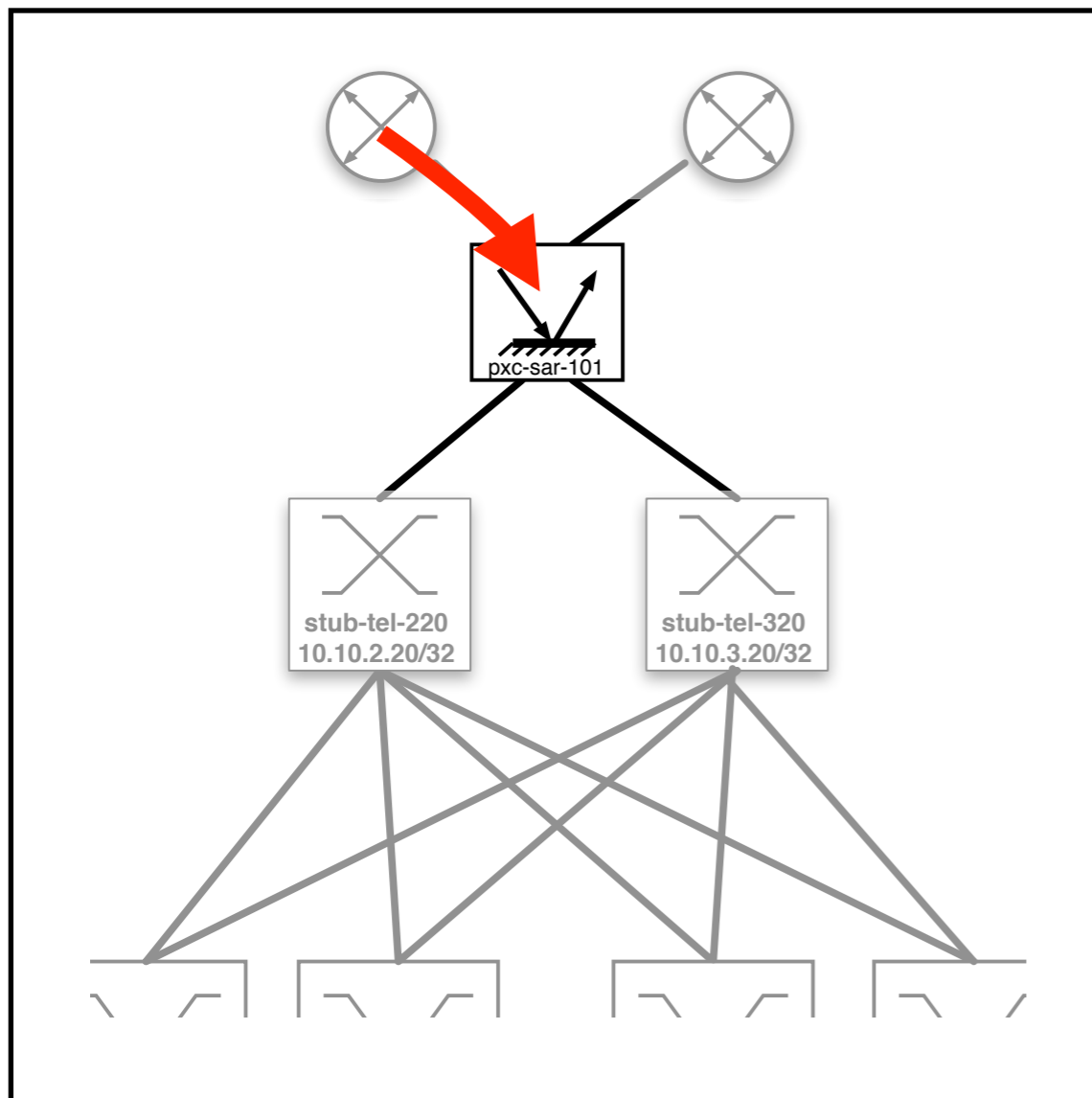

Layer 1 switching

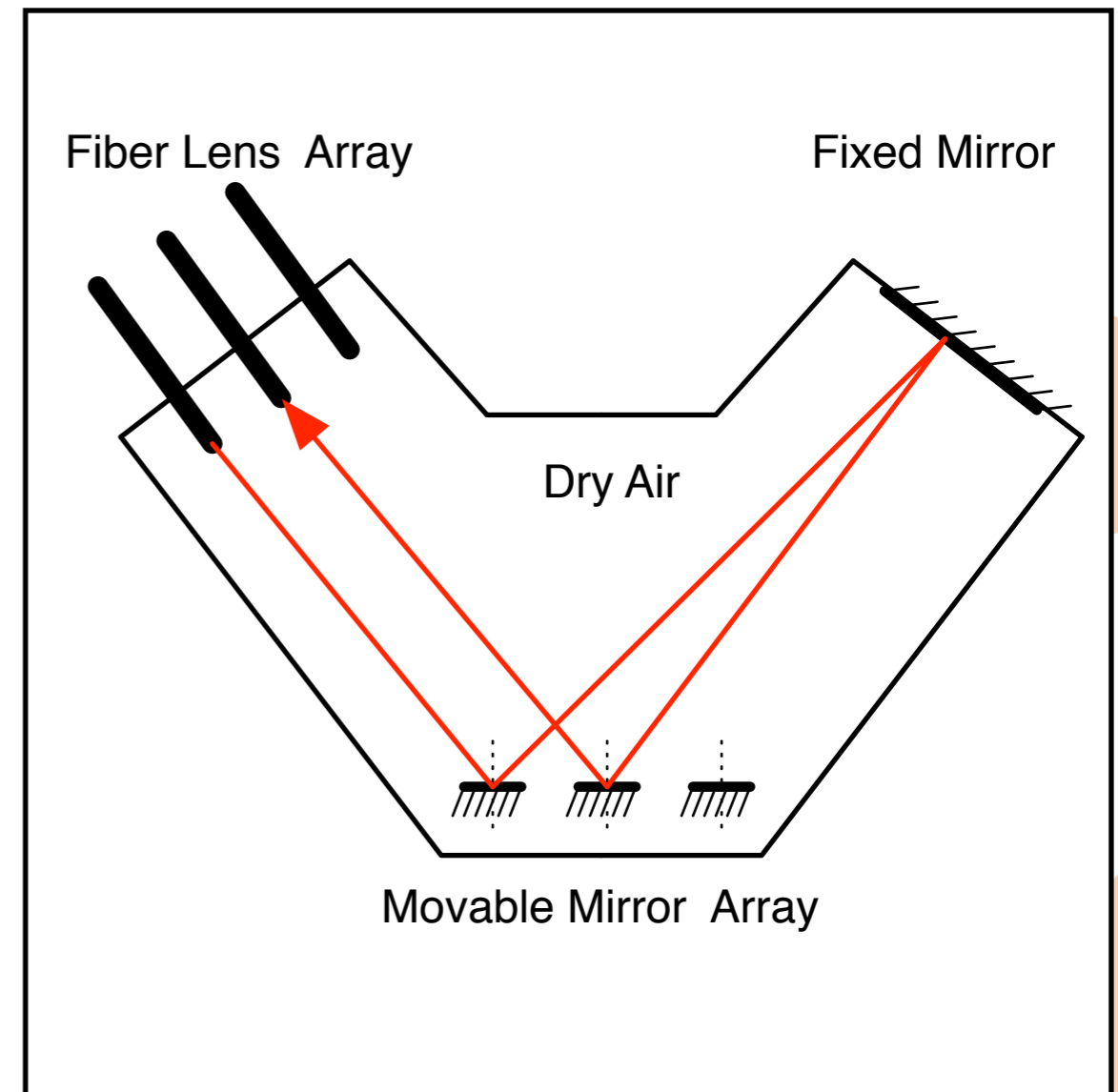
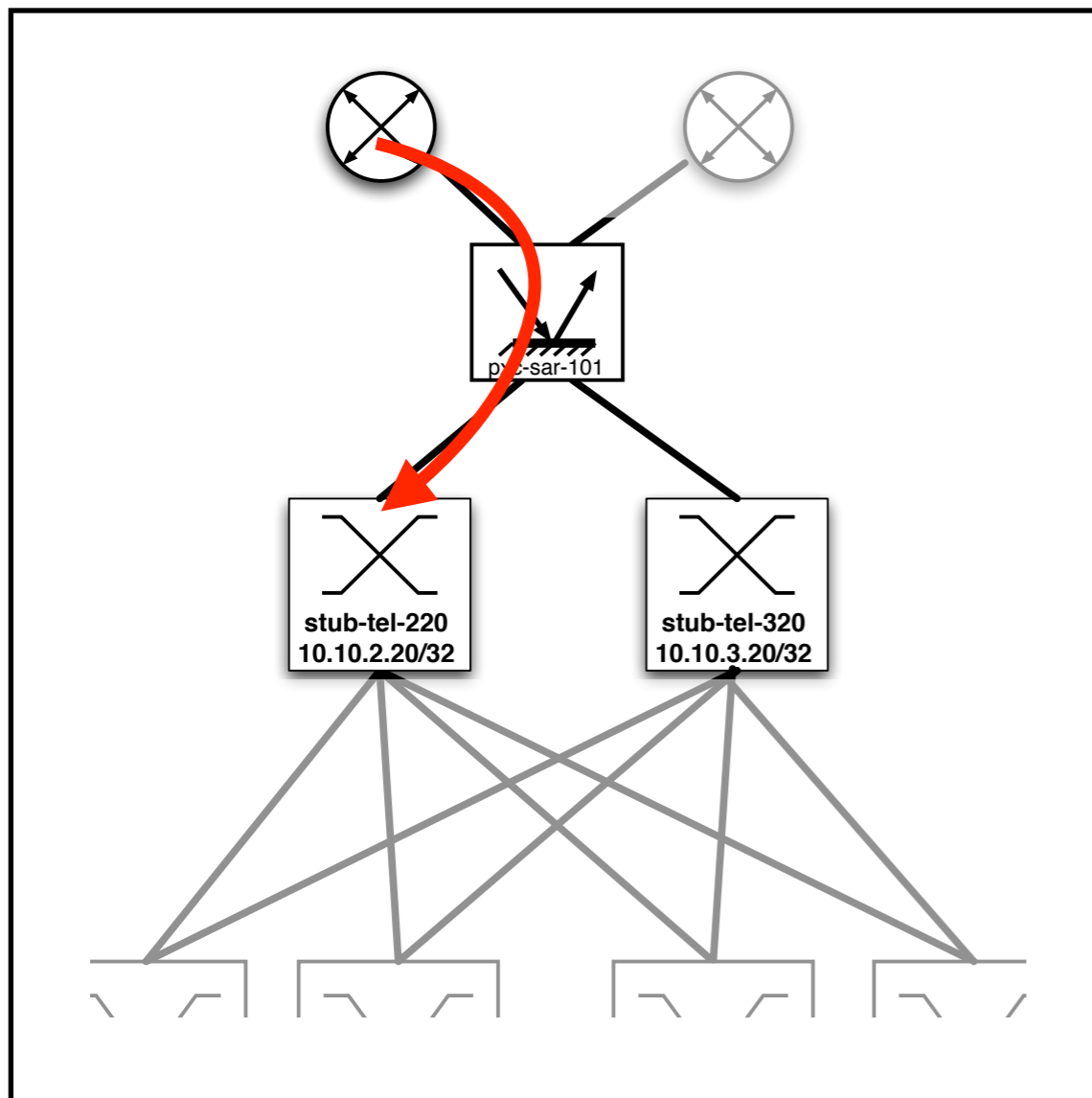

Layer I switching

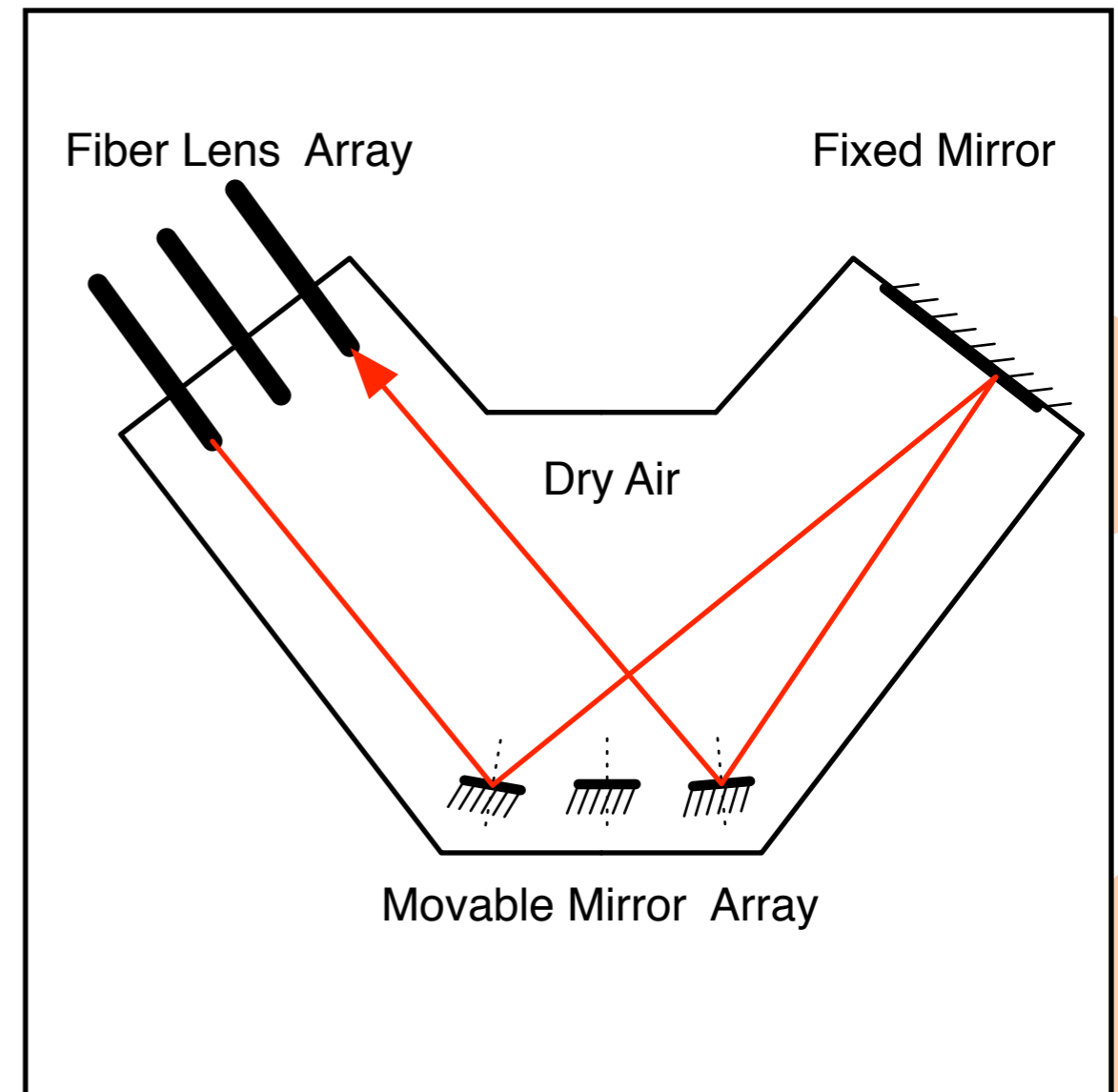
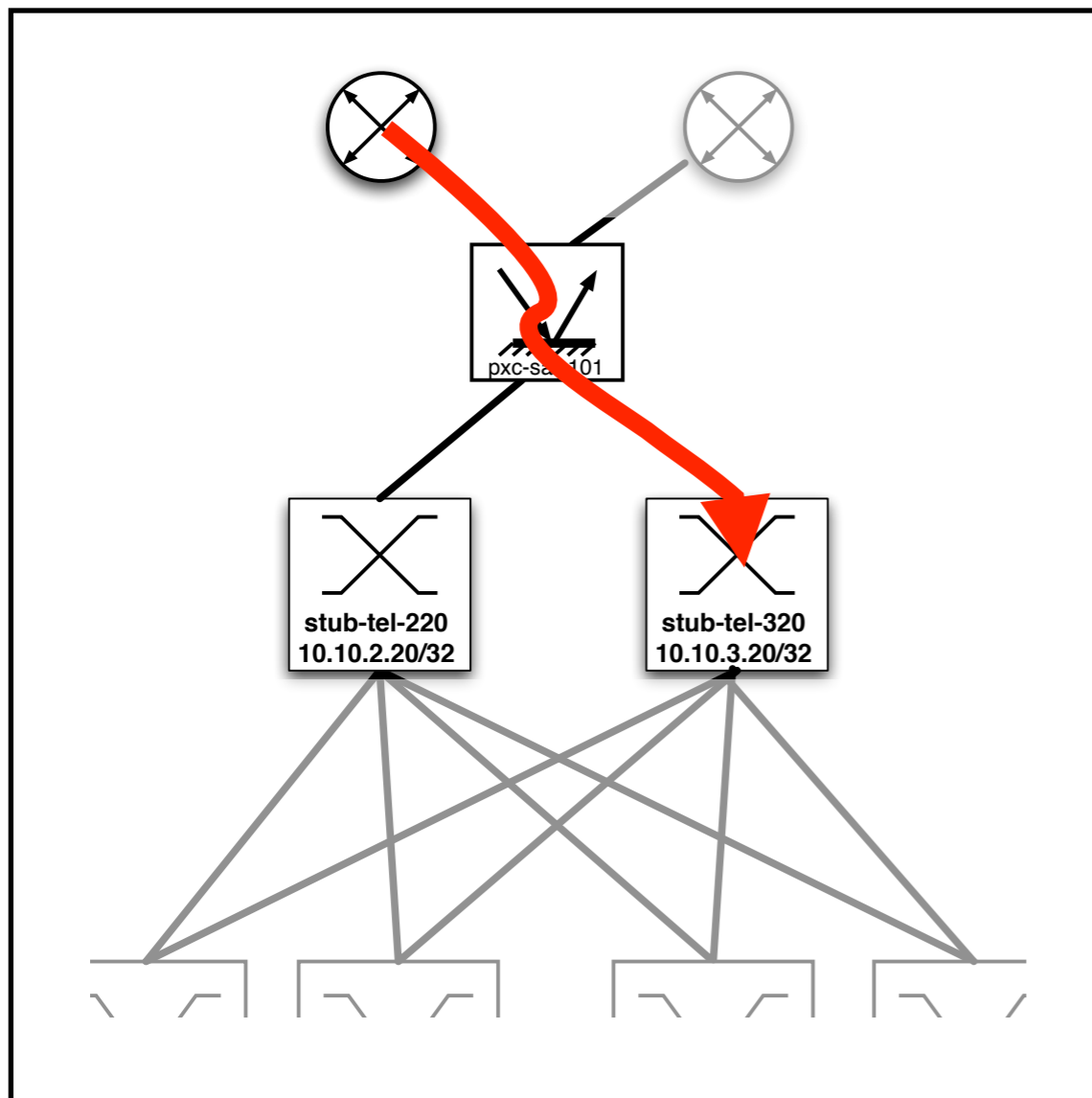

Cabling

- Parallel fibre
 - Increased interconnection costs
 - Recurring costs!
 - Possibly port density issues in the MMR
 - Large number of “layer one” ports
 - Equipment density problems

Cabling

- Please design for duplex, single mode fibre
- This fits the existing infrastructure and business practices
- Parallel fibre has a lot of practical problems
- Operational costs of parallel fibre will definitely be higher than duplex fibre

Agenda

- **Requirements for 400Gb/s Ethernet**
 - Fibre type and view on parallel fibre
- **Link aggregation**
- Costs compared to existing technology

Link aggregation

- Link aggregation is a hard requirement
- We already have aggregated 100Gb/s links
 - Two 2x100Gbit/s customer links
 - Two more on the way
 - Ten 2x100Gbit/s backbone links
- We expect 4x100Gb/s links in 2015

Agenda

- **Requirements for 400Gb/s Ethernet**
 - Fibre type and view on parallel fibre
 - Link aggregation
 - **Costs compared to existing technology**

Costs

- Financial costs
 - $\leq 2.5 \times 100\text{Gb/s}$
- Port density
 - One 400Gb/s port should not replace more than two 100Gb/s ports

End