



IEEE802.3 4P Task Force
Channel Pair To Pair Resistance Unbalance (CP2PRUNB)
(only cables and connectors)
Analysis of ad-hoc proposed use cases
Rev 004c

July 2014

Yair Darshan
Microsemi
ydarshan@microsemi.com

Supporters

- Chris Diminico
- Larsen, Wayne / Commscope
- Leonard Stencel / Bourns
- David Tremblay / HP
- Fred Schindler / Seen Simply
- Lennart Yseboodt / Philips
- Christian Beia / ST
- Matthias Wendt / Philips
- George Zimmerman/ CME Consulting, Affiliations: Commscope & Aquantia
- Jean Picard / TI
- Kousalya Balasubramanian / Cisco
- Pavlick Rimboim / MSCC
- Brian Buckmeier / BEL
- Sesa Panguluri / Broadcom

Objectives

- To close the TBDs (P2PRUNB and Resistance Difference) from base line text motion from May 2014 meeting.
- To verify that during Channel P2PRUNB compliance tests we can pass the above requirements with realistic use cases while what is considered not typical or realistic use cases are covered too by the above requirements in a clear way and not subject to confusion or false interpretation.

The Channel Only. See Annex F for the entire system (UPDATE)

DRAWING

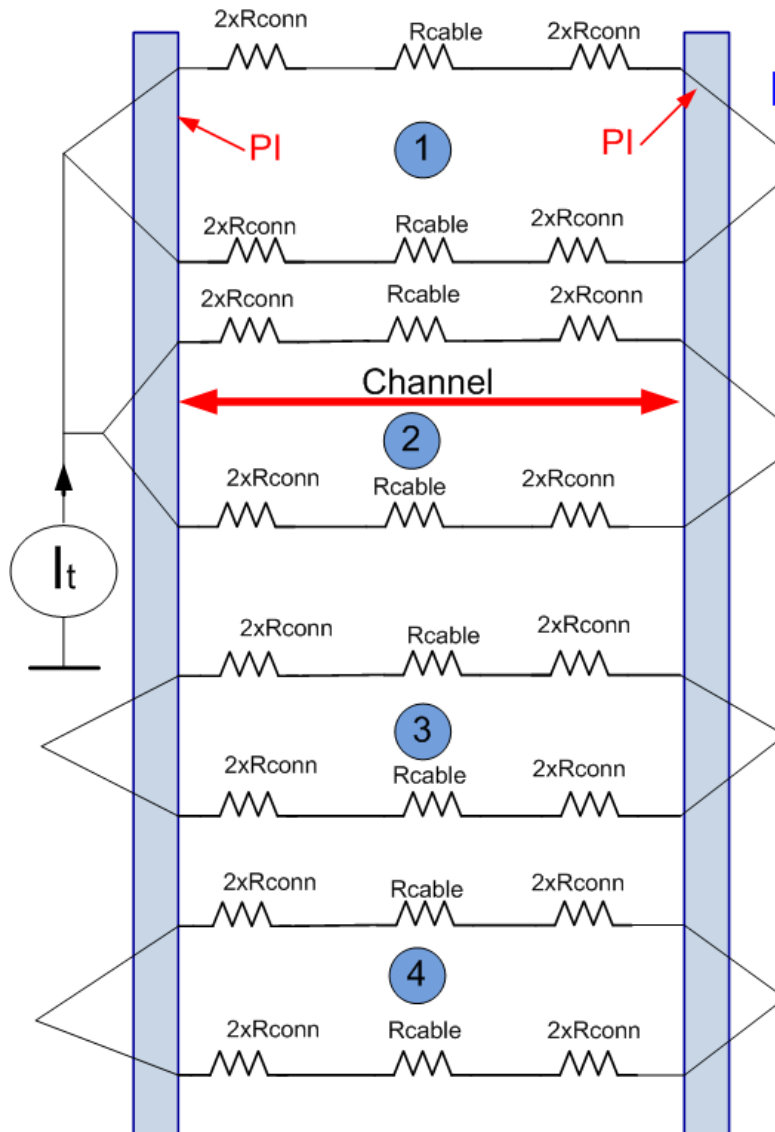

$$R_{max} = (R_{cables_max} + N * R_{c_max}) / 2$$

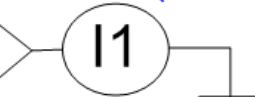

N= number of connectors, 0 to 4

$$R_{min} = (R_{cables_min} + N * R_{c_min}) / 2$$



C_P2PRUNB is defined between any two pairs
Each pair has two wires in parallel from power delivering point of view

$$\frac{I_2 - I_1}{I} = \frac{\sum R_{max} - \sum R_{min}}{\sum R_{max} + \sum R_{min}} =$$

$$C_P2P_R_UNB = C_P2P_Current_UNB$$

$$R_{cables_max} = (L1 * L1_r_m_max + L2 * L2_r_m_max) / 2;$$









$$R_{cables_min} = R_{cables_max} * (1 - P2P_Cable_RUNB) / (1 + P2P_Cable_RUNB);$$

$$R_{min} = n * r_{c_min} / 2 + R_{cables_min};$$

$$R_{max} = n * r_{c_max} / 2 + R_{cables_max};$$

$$Ch_P2P_Runb = 100 * (R_{max} - R_{min}) / (R_{max} + R_{min});$$

Adhoc proposed channel use cases

Use Case #	Description					
A	Cordage=0.15m					
B	Cordage=1m	Cable=3m	Connectors			
						
C	Cordage=8m	Cable=15m				
D	Cordage=10m	Cable=90m				
						

- Due to the fact that we cannot force the typical use case, other use cases, that exhibit high number of connectors per channel length, that are considered not typical or unrealistic ones, were analyzed to verify our sensitivity to such use cases.
- The results will help us to verify if our channel spec is complete and robust.

Channel P2P RUNB-Addressing TBDs

- **In May 2014 we vote for the following base line text highlighting the TBD areas.**

33.1.4.3 Pair Operation Channel Requirement for Pair to Pair Resistance Unbalance

4P pair operation requires the specification of resistance unbalance between each two pairs of the channel, not greater than **200 milliohms** or **6%(TBD)** whichever is greater. Resistance unbalance between the channel pairs is a measure of the difference of resistance of the common mode pairs of conductors used for power delivery. Channel pair to pair resistance unbalance is defined by

- **We need to address two numbers:**

$C_{P2PRUNB}=6\%(TBD)$ and Resistance Difference=200milliOhm.

The value of channel maximum Rdiff

- The **200milliohm** in the channel base line text from May 2014 above should be 0.1Ω . Why?
- Connector max Rdiff= 0.05Ω . 4 connectors is $4*0.05\Omega=0.2\Omega$ on each Wire. As a result, a pair is two connectors in parallel $\rightarrow 0.1\Omega$
 - Connector maximum resistance is 0.2Ω and is not related to the discussion here which is pair to pair resistance difference.

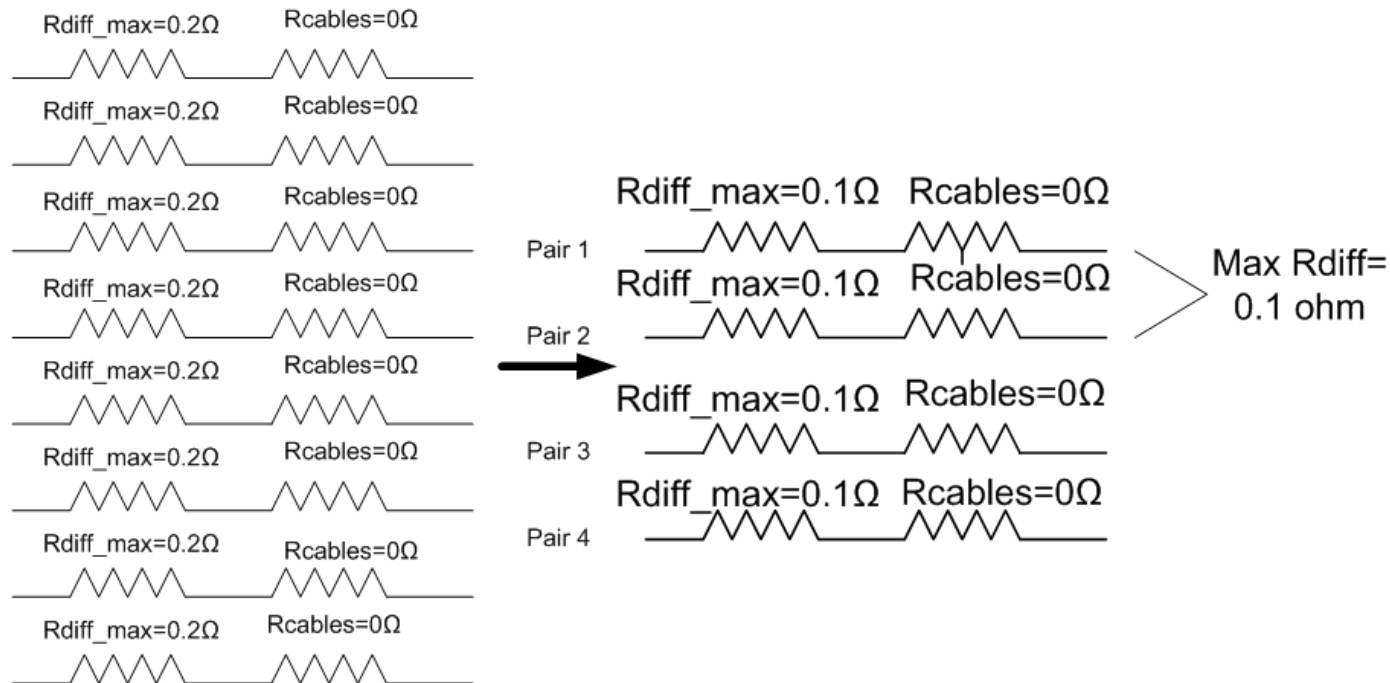

Source: Yair Darshan.
Confirmed by Wayne Larsen

Presentation Flow

Step	Analyzing the proposed use cases
1	a) Compare analysis results of proposed use case A,B,C and D to 6% b) Checking other use cases near the proposed use cases to check the Channel P2PRUNB sensitivity from deviation from the proposed use cases.
2	Understanding the reasons and rationale behind the results from different angle and as function of channel parameters
3	Checking if P2PRUNB and Rdiff is sufficient to specify the channel for any use case.
4	Checking if Rdiff alone is sufficient to define the channel
5	Conclusions and information obtained from this work regarding: -Channel -Future work on PSE and PD PI.

Channel Component Data used in this work

#	Component	Value	Reference
1	Patch Cord	0.0926Ω/m	Adhoc for worst case analysis (Cable with AWG#24 wire)
		0.14Ω/m	Adhoc, Standard.
2	Horizontal Cable	CAT6A AWG23	1. Adhoc 2. See Annex G1, G2, G3, E1 3. See Slide “Annex K20”
3	Connector	Rmin=0.03Ω Rdiff_max=0.02Ω Rmax=0.06Ω	1. Rdiff (TBD) : Adhoc 2. Rmin, Rmax: Adhoc 3. See Annex G1, G2, G3, E1-E6 4. See Slide “Annex K20”

Table 1

Questions such:

1. Why not to use 0.098 Ω/m as per standard etc. are answered in annexes above. If more data is needed, please address this question to the reflector.
2. Why not use Rmax=0.2Ω and Rdiff_max=0.05Ω for connector? Answer: It is maximum values and for worst case analysis we need minimum values for Rmax and Rmin and a maximum practical values for Rdiff.
3. The conclusions that was derived from the analyzed topics in this work topics, will not change dramatically for other practical data number sets.

Use cases to be checked during analysis

- **From previous ad-hoc meetings decisions:** To check use cases A, B, C and D per the table below for Channel P2PRUNB specification derivation.
- Additional use cases were added (total 16 at a time) after running the simulations in order to find Channel P2PRUN hidden peaks for specification sensitivity analysis.
- Table below provides a summary. **See details next slides.**

Use case	Connectors	Cordage[m]	Cable[m]	Max. Channel P2PRUN
A	0	≥ 0.15	0	5% (equal to Cable P2PRUNB)
	0	0	≥ 0.15	
B	2	1	3	9.2% (Covered by the Rdiff requirement)
C	4	8	15	6.47%
D	4	10	90	5.45%
2-4, 6-8 10	1 2 4	See curve next slide. Considered as unrealistic use cases		10% - 20% (Covered by the Rdiff requirement)

See curve next slide for more data

Use case analysis results and proposed objective

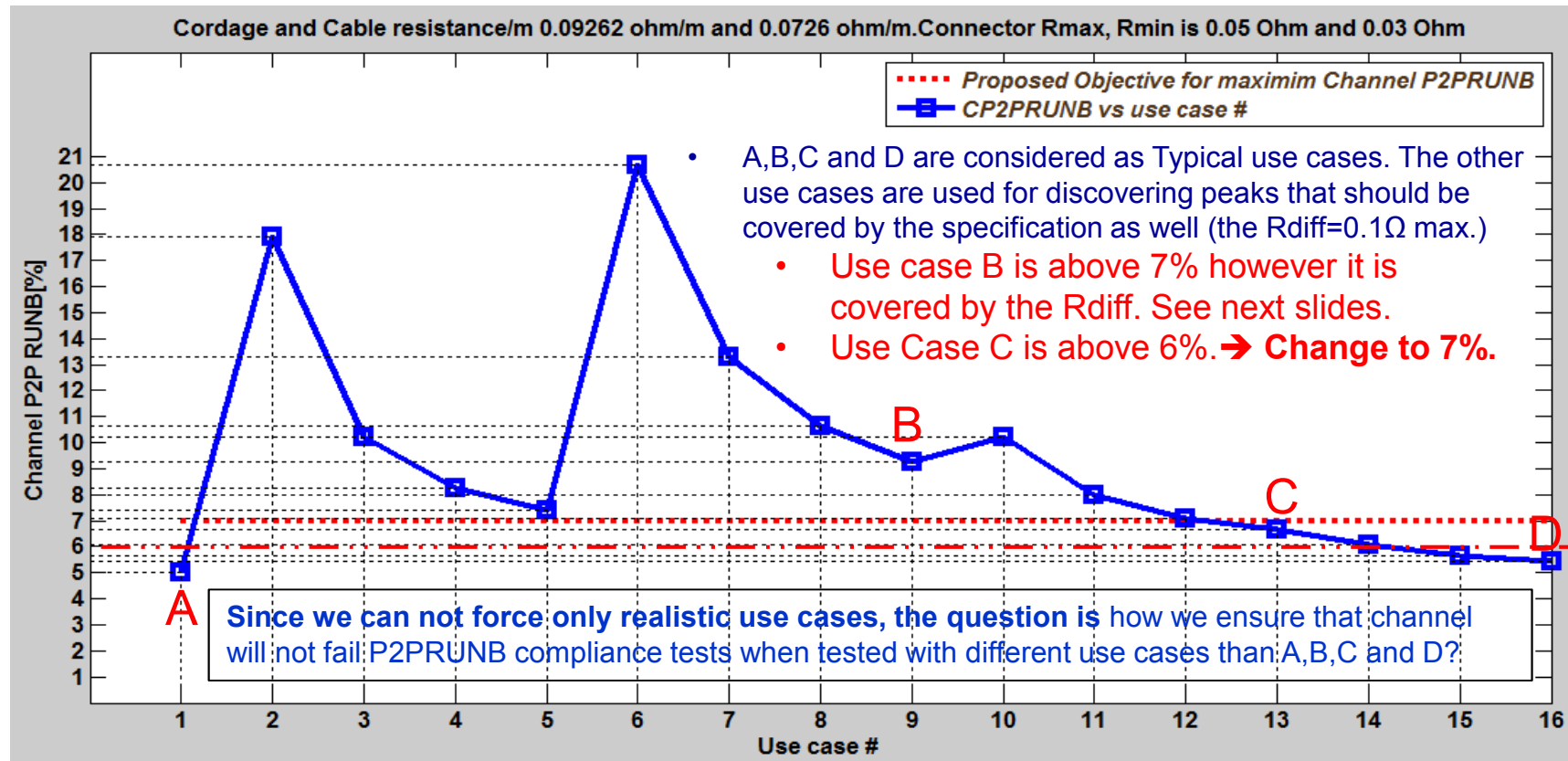

	A							B					C			D	
n =	[1,	2,	3,	4,	5,	6,	7,	8,	9,	10,	11,	12,	13,	14,	15,	16];	Use Case Number
L1=	[0,	1,	1,	1,	1,	2,	2,	2,	2,	4,	4,	4,	4,	4,	4,	4];	number of connectors
L2=	[0,	0,	1,	2,	3,	0,	1,	2,	3,	4,	8,	12,	15,	30,	60,	90];	Cable[m]



Channel P2PRUNB vs. Use case parameters

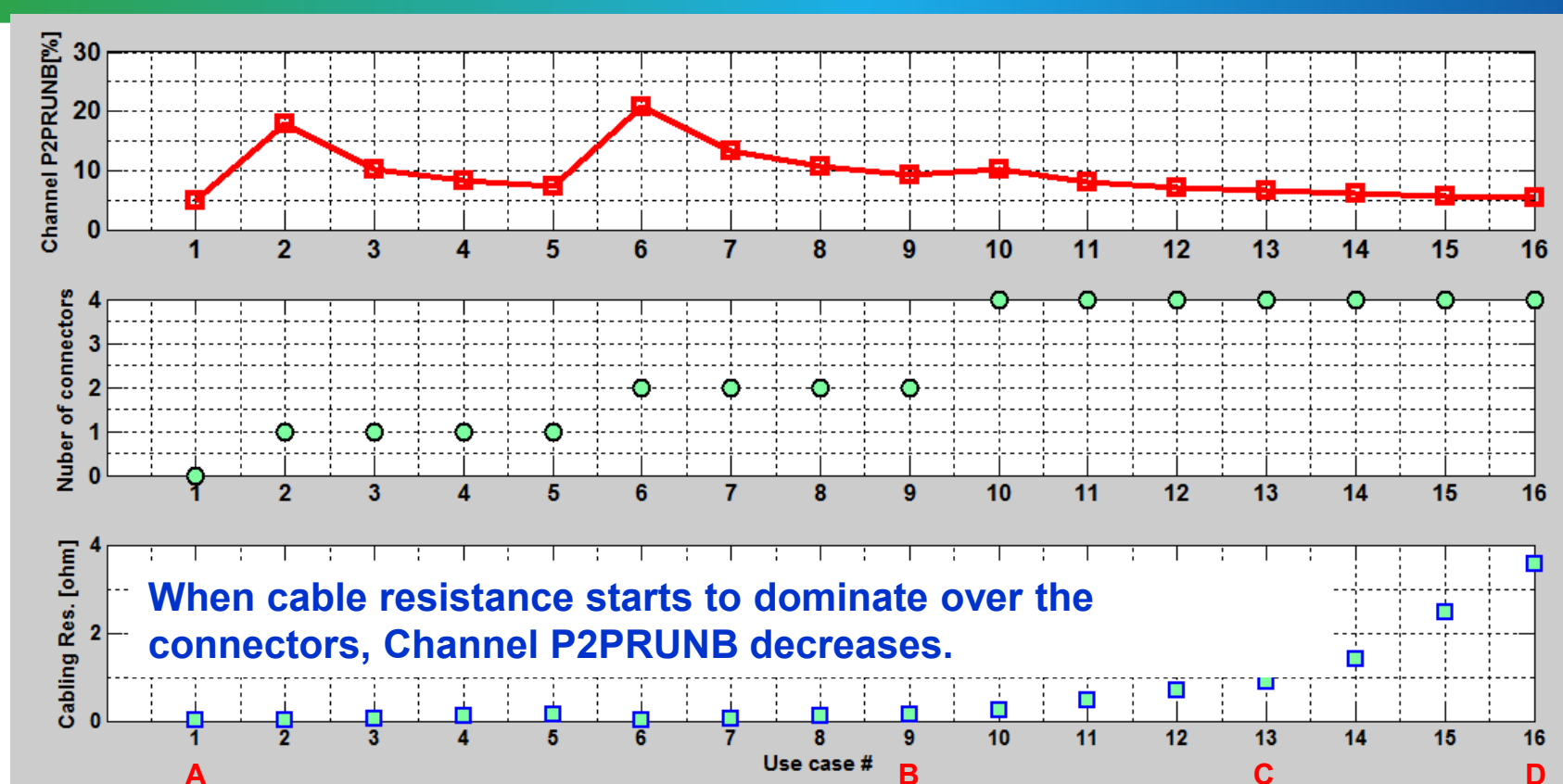

	A								B			C			D		
n =	1,	2,	3,	4,	5,	6,	7,	8,	9,	10,	11,	12,	13,	14,	15,	16,	Use Case Number
L1=	0,	0.25,	0.5,	0.75,	1,	0.25,	0.5,	0.75,	1,	2,	4,	6,	8,	8,	9,	10,	number of connectors
L2=	0,	0,	1,	2,	3,	0,	1,	2,	3,	4,	8,	12,	15,	30,	60,	90,	Cordage[m]
																	Cable[m]



Channel P2PRUNB vs. Cable resistance and connectors

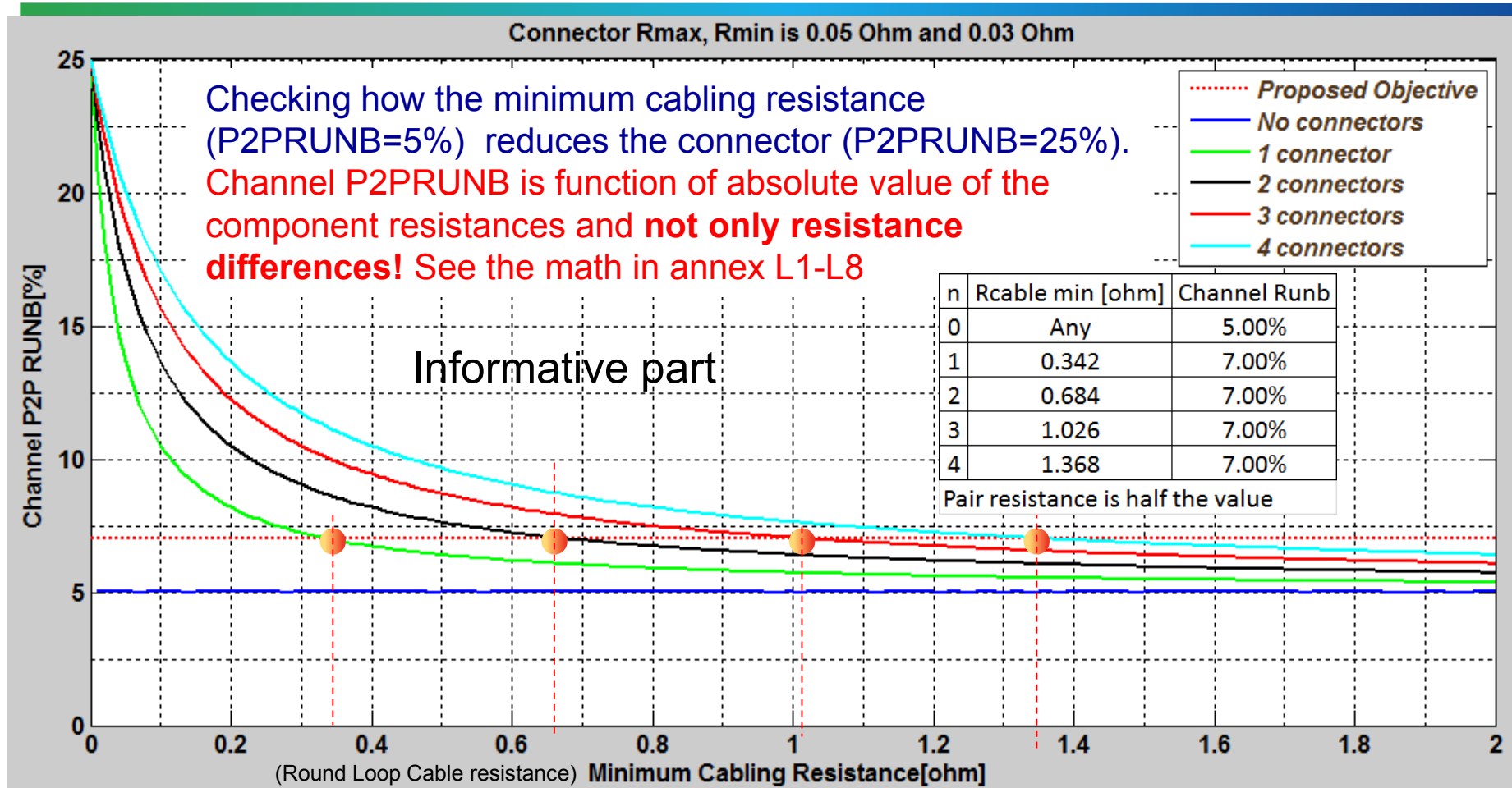

- Connector P2PRUNB = $100\% * (50 - 30) / (50 + 30) = 25\%$
- Cable P2PRUNB = 5%.
- Channel P2PRUNB: See 5 curves with different connector numbers

Use case analysis results – Sanity Check -1

Zooming on the peaks by *Changing X axis for Cabling Minimum resistance*

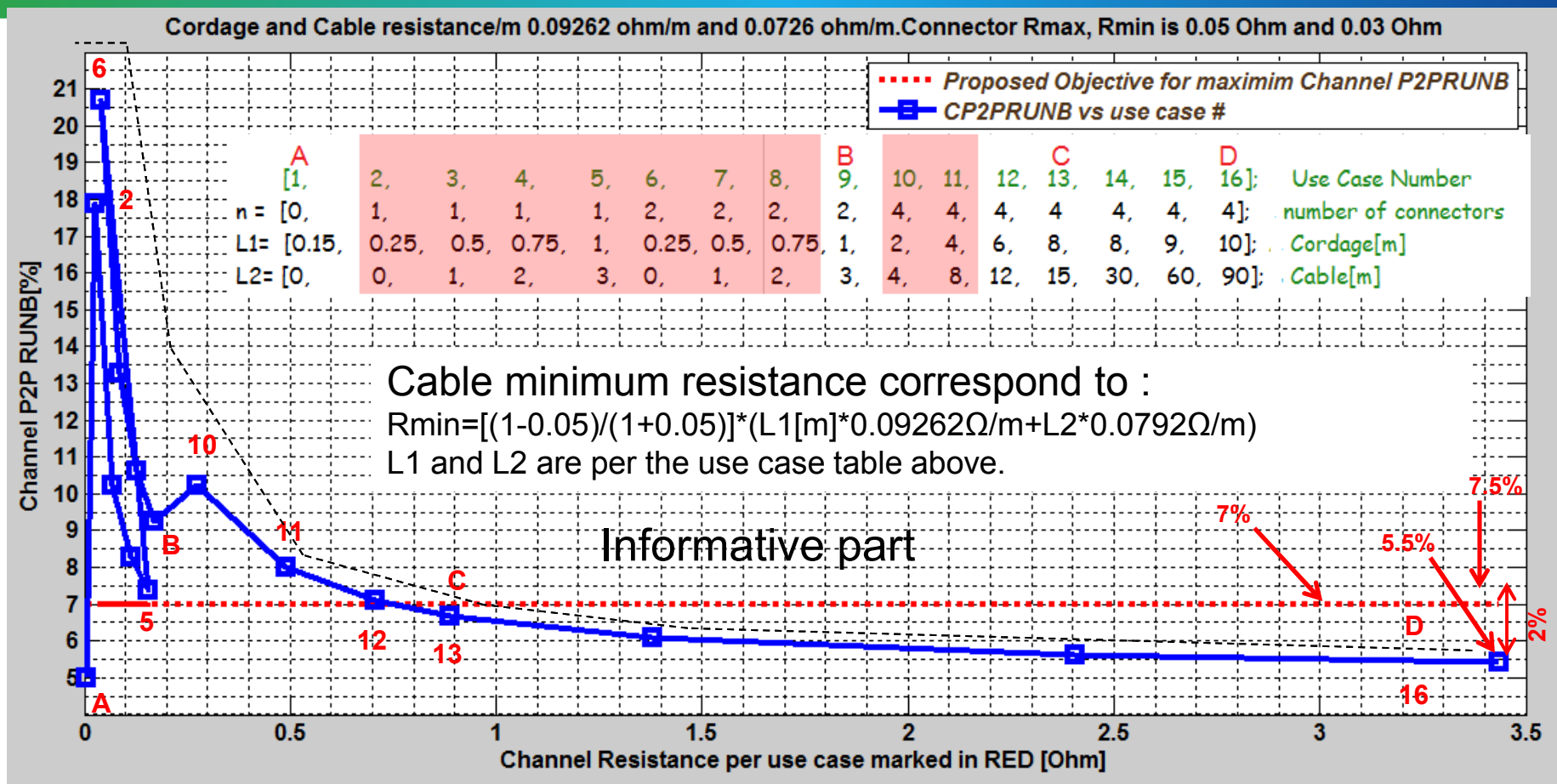

- Unrealistic use cases are now concentrated in minimum cabling resistance region.
- 0.7Ω minimum cabling resistance for a channel with 4 connectors, is required to reduce all CP2PRUNB peaks to below 7% (L1+L2~12m total per use case # 12 in the table above).
- We may not need to require minimum channel length of 12m however it is nice to know that above 12m the channel is acting as ballast resistor to the PSE and PD PI.*

Use case analysis results – Sanity Check -2

Zooming on the peaks by *Changing X axis for Channel Resistance Difference*

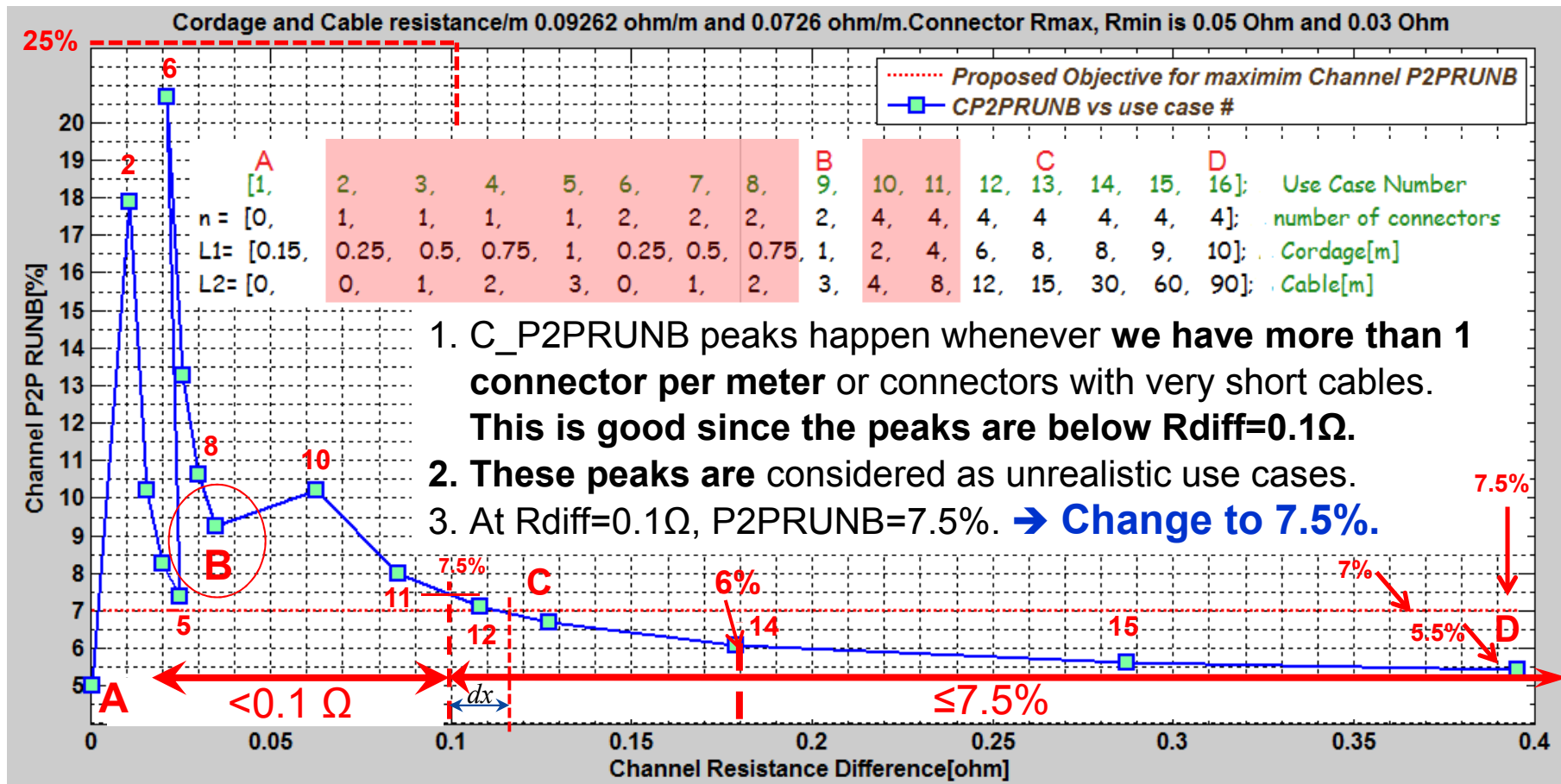

- The realistic use cases A,B,C, and D looks good. B is below Resistance Difference=0.1Ω
- Rdiff is increased as cable total resistance is increased. As a result Rdiff alone cannot be used for specifying the channel we must have the C_P2PRUNB[%] too as expected.

See Annex L7-L8 for details.

Conclusions regarding Channel Unbalance Requirements -1

- We can see that the high C_P2PRUNB peaks happen when:
 - There are more than 1 connector per 1m of cabling (ratio of 0.22 to 0.25) and/or:
 - The cables and patch cords are short and exhibit low resistance compared to total connector resistance
 - The above use cases are considered "unrealistic" ones, covered by $R_{diff}=0.1\Omega$ (was 0.2Ω).
- Use Case B is considered to be realistic, and exceeds the initial proposed 7% but it is covered by $R_{diff}=0.1\Omega$ (was 0.2Ω) requirement.
 - It has 2 connectors over 4m channel which is $2/4=0.5$ ratio which is way different that the general behavior above of 0.25 ratio. So all is good
- We saw that:
 - Per the R_{diff} curve: we can select the specification numbers between:
 - (a) $R_{diff}=0.1\Omega$, P2PRUNB=7.5%. (b) $R_{diff}=0.117\Omega$, P2PRUNB=7%. (c) $R_{diff}=0.1\Omega$, P2PRUNB=7%.
 - **Option (a) is the correct one from worst case analysis point of view.**
 - Option (b) is not matching the maximum P2P R_{diff} per connector standards $=0.1\Omega$
 - **Option (c) is possible if counting on the fact that it is worst case analysis and we have design margins for small deviation of 0.5%/0.025 Ω . which may be the best optimized cost effective set of parameters.**
- We may need informative section that says that for 4P operation, it is recommended to use a channel that has ≤ 1 connector per meter (maximum 4 connectors per standard). Anyway, unrealistic use cases are covered by R_{diff} part in the spec.

Conclusions regarding Channel Unbalance Requirements -2

- 4P operation with minimum cable resistance help us:
 - (a) It will reduce some of the burden on PD PI and PSE PI
 - (b) It helps to reduce overall End to End Channel P2P RUNB and as a result will reduce the maximum current over the pair with lowest end to end resistance.
- The implication of the above is equivalent to minimum cable length.

- This work shows clearly (by analytical proof and simulations) the following facts:
- **Only Resistance Difference Requirement** for Channel specifications ($R_{diff}=|R_{max}-R_{min}|$) is mathematically and practically insufficient. See L1 –L8 for analytical derivation. This requirement leads to clear interoperability issues. See L7 and L8. In channel, in particular, it will contradict cable 5% P2PRUNB maximum limit. So we need at least both R_{diff} and P2PRUNB parameters for the channel as we have already in the base line text. Moreover inexplicitly, for channel $R_{dif} \leq 0.1\Omega$, P2PRUNB is bounded by the connector P2PRUNB (25% per the data used in this work).

Summary

- The proposed unbalanced parameter values for the base line text are:
 - Channel P2PRUNB max.: 7.5% (option a) or 7% (option c)
 - Resistance Difference max: 0.1Ω
 - (P2PRUNB for $R_{diff} \leq 0.1\Omega$ is bounded by Connectors actual R_{min} , R_{max} values i.e. 25% in our analysis. Theoretically it can be higher and it will be bounded by system unbalanced parameters)
- Adhoc use cases proposals covers:
 - Realistic use cases with short cables and long cables
 - "unrealistic" use cases with short and long cables as well that we actually cannot control or limit their use.
 - It is worst case analysis, therefore contain inherent margins
 - It is complete.

Proposed update to Channel base line text

Specify Channel Unbalance parameters to:

C_P2PRUNB=7.5% max.

Channel Resistance Difference=0.1Ω max.

Which ever is greater.

Notes:

1. 7% is the cost effective choice per the conclusions slides.
2. 7.5% is the accurate solution.

Group to discuss.

Q&A

Backup slides

The following is the subject for future work:

In TIA/EIA/ISO/IEEE specifications, for pair Runb (wire to wire within a pair), only Runb and Rdiff was specified. For P2P definition especially for short channels, it will be advantageously specifying:

- $P2PRUNB \leq 25\%$ (TBD) for $R_{diff} \leq 0.1\Omega$ **or** alternatively:
- specifying R_{min} for the channel with $R_{diff} \leq 0.1\Omega$.

See Annex L1-L8, P, P1.

This will put upper bound for P2PRUNB at $R_{diff} \leq 0.1\Omega$ region.

Proposed Next steps for the PSE and PD PI models - 2

- PSE PI unbalance parameters
- PSE PI unbalance parameters shall include:
 - P2PRUNB[%]
 - Voltage Difference.
- For complete spec, check if adding Rmin is needed or we can satisfied with only the above 2. See Annex L1 –L6 for our options.

- PD PI unbalance parameters
- P2PRUNB[%]
- Voltage Difference.
- For complete spec, check if adding Rmin is needed or we can satisfied with only the above 2. See Annex L1 –L6 for our options.

Use case analysis results – Sanity Check

Zooming on the peaks by *Changing X axis for Channel Resistance Difference*

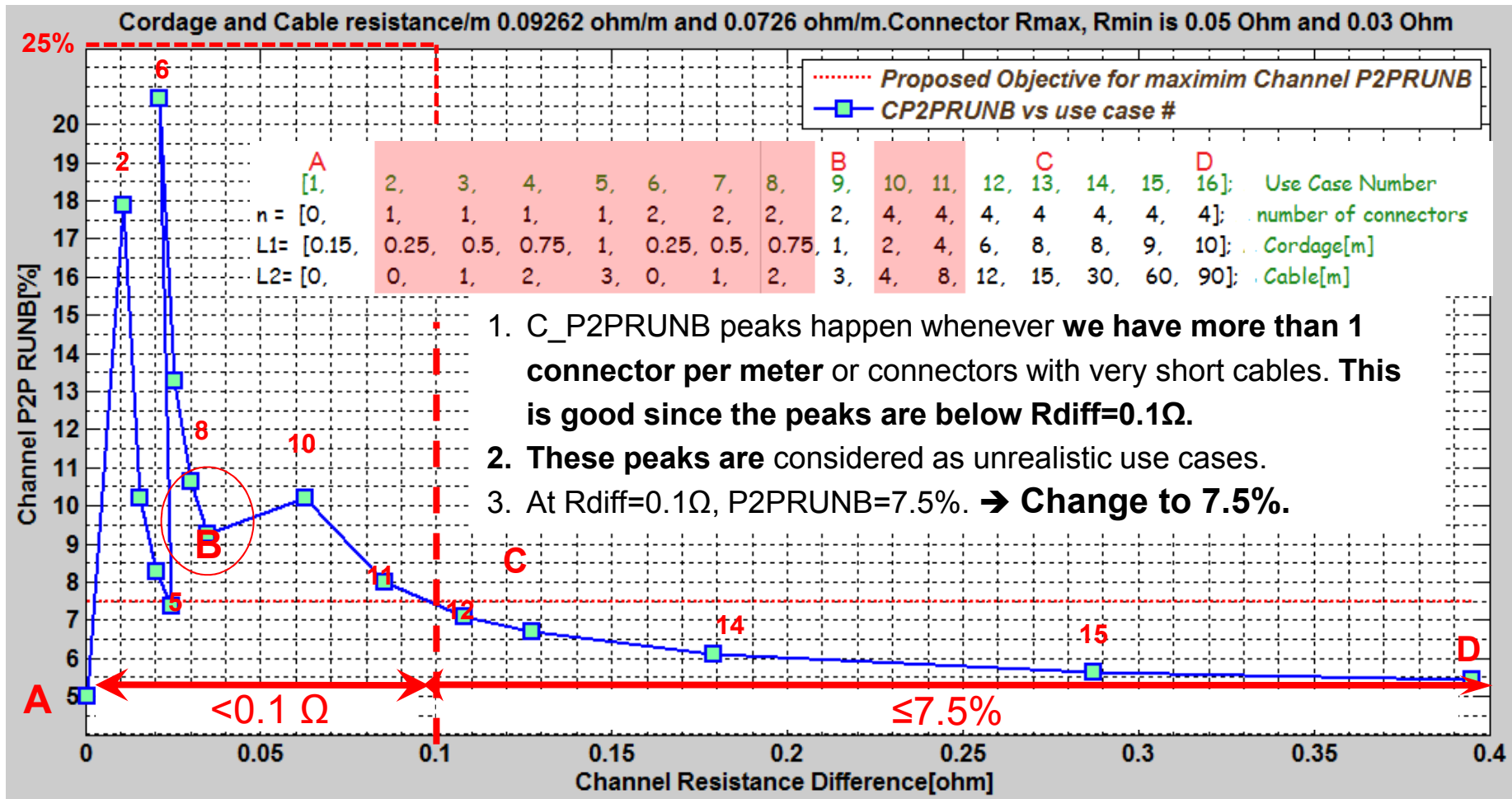

- With 7.5% C_P2PRUNB limits.

Channel P2PRUNB use cases vs. Cable resistance per meter.

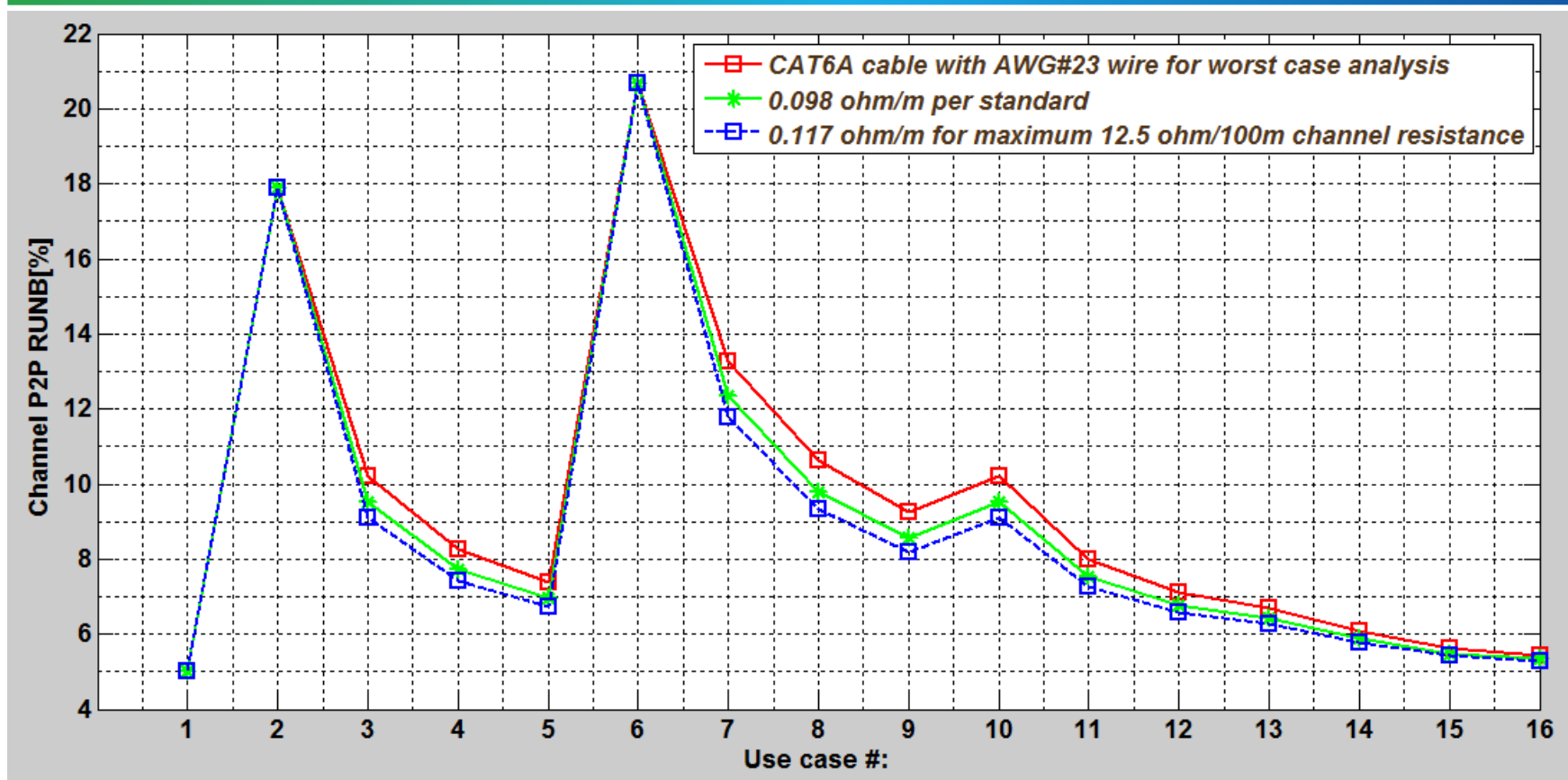

- As can be seen, CAT 6A cable with AWG#23 need to be selected for worst case analysis.
 - When we analyze the end to end Channel P2PRUNB, the 0.117Ω/m will be used too for generating maximum channel current.
- Standard value 9.8Ω/100m is maximum value which is between the two other cables. As a result, it will not be used for the purpose of this work.



Use case analysis results with connector $R_{diff}=0.015\Omega$ instead 0.02Ω .

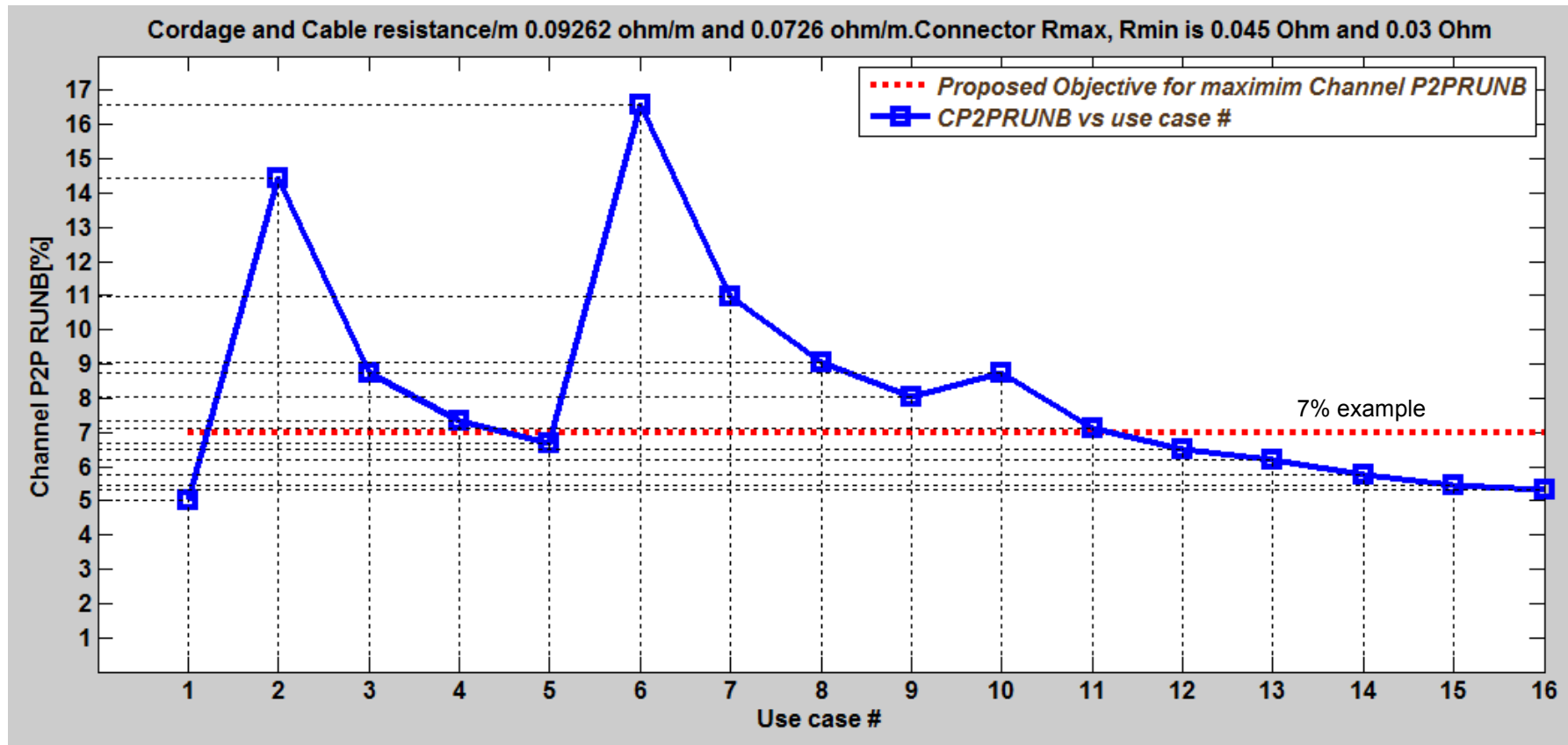

- Lower peaks received with using connector $R_{diff}=0.015\Omega$ instead of 0.02Ω compared to previous run.

	A	B	C	D	
n =	[0,	1, 1, 1,	1, 2, 2, 2,	2, 4, 4, 4,	4, 4, 4, 4];
L1=	[0.15,	0.25, 0.5, 0.75,	1, 0.25, 0.5, 0.75,	1, 2, 4, 6,	8, 8, 9, 10];
L2=	[0,	0, 1, 2,	3, 0, 1, 2, 3,	4, 8, 12,	15, 30, 60, 90];

Use case analysis results with connector $R_{max}=0.2\Omega$ $R_{diff}=0.05\Omega$ -1

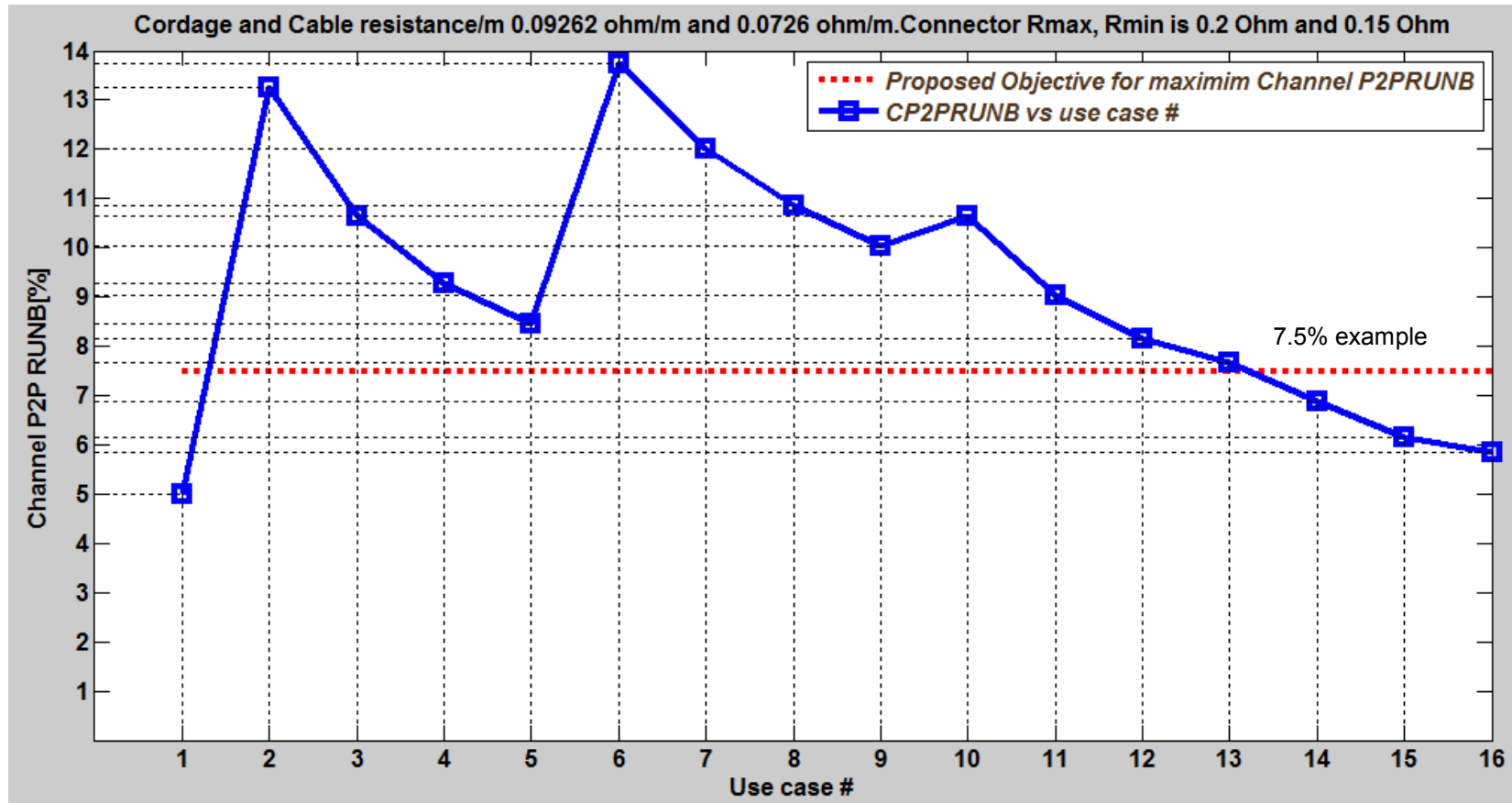

- This use case is unlikely to happen although it represent connector R_{max} and R_{diff} maximum values per standard while we are looking for minimum values for worst case analysis.
- Peaks are lower than $R_{max}=0.05\Omega$ and $R_{diff}=0.02\Omega$.
- See more effective view when It will require higher R_{diff} e.g. 0.2 instead of 0.1 to cover all use cases including use case B which is considered to be realistic one.

Use case analysis results with connector $R_{max}=0.2\Omega$ $R_{diff}=0.05\Omega$ -2 $C_{P2PRUNB}$ vs R_{diff}

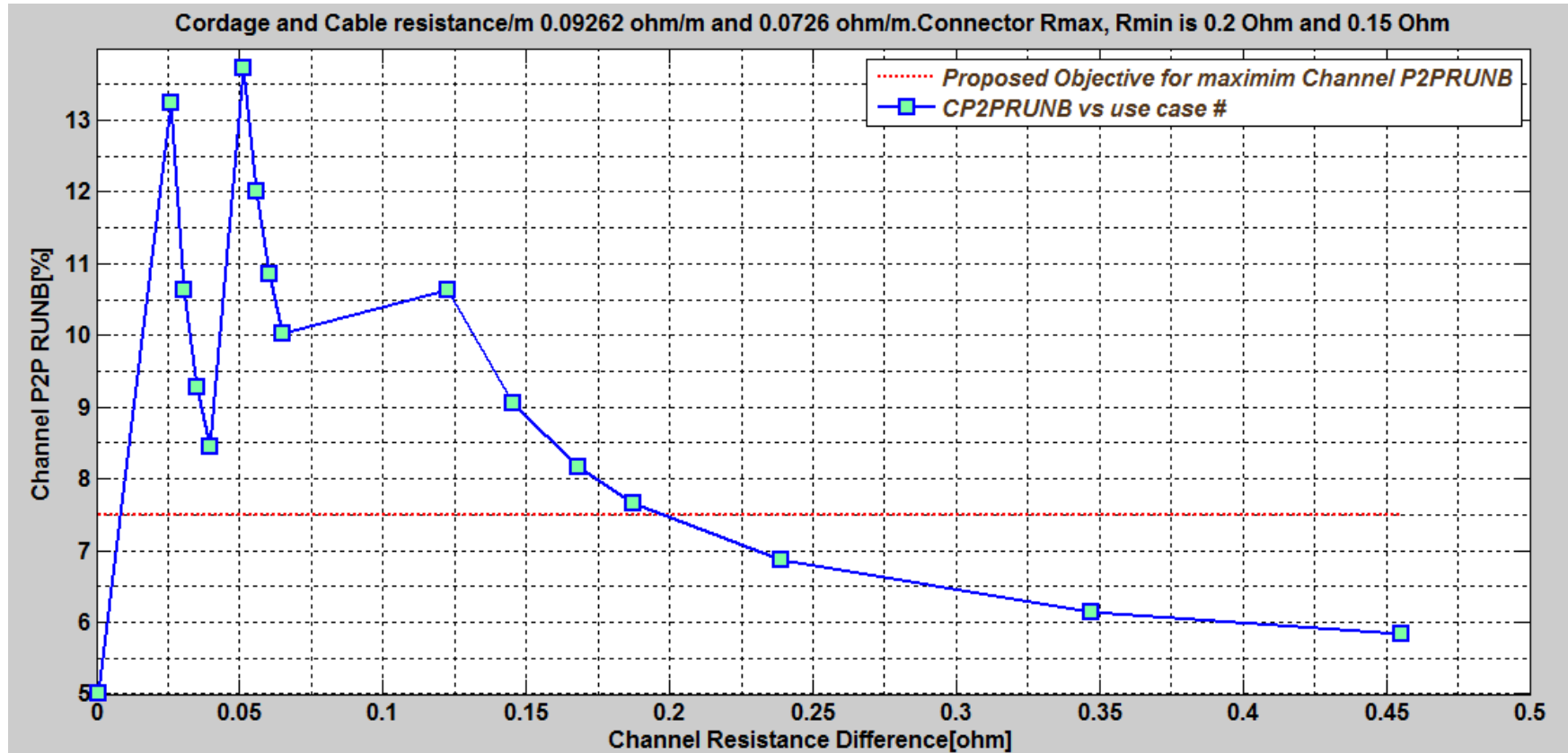

- Confirming that using connector maximum standard numbers contradicts P2P $R_{diff}=0.1\Omega$. It generates higher peaks above $R_{diff}=0.1\Omega$ and requires $\sim 10.5\%$ $C_{P2PRUNB}$ definition instead of 7.5% at $R_{diff}=0.1\Omega$ which is highly unlikely to happen per connector data and process evaluation when converting process parameters (mean, sigma etc.) of $R_{max}=0.2\Omega$ $R_{diff}=0.05\Omega$ to actual worst case minimum/maximum/ R_{diff} of connectors used in this work $0.05/0.2 \rightarrow 0.02/0.06$. See worst case data base)

Channel P2PRUNB vs. Cable resistance and connectors

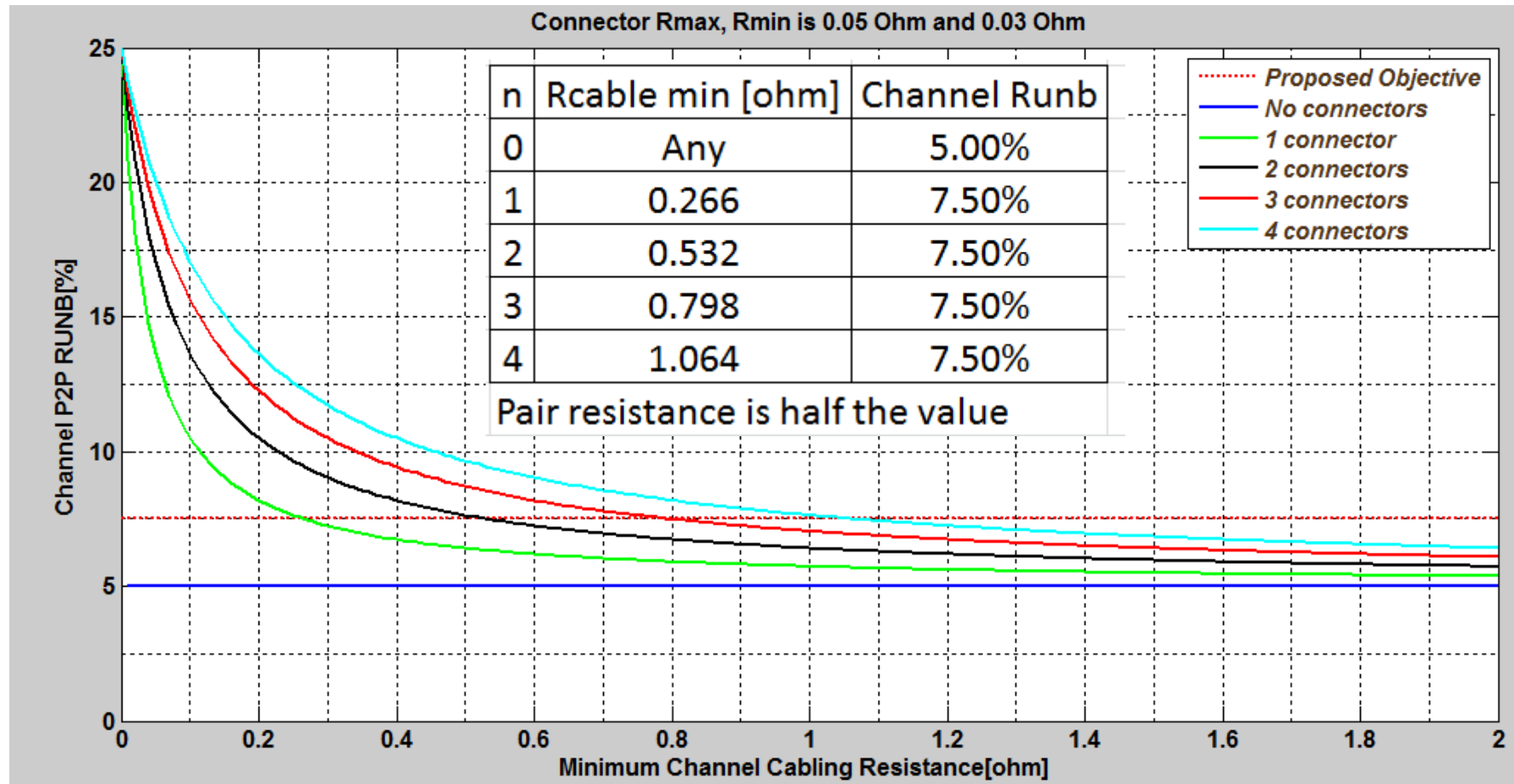

- With 7.5% C_P2PRUNB limits.

Previous work: Using setup that filters unrealistic use cases -1

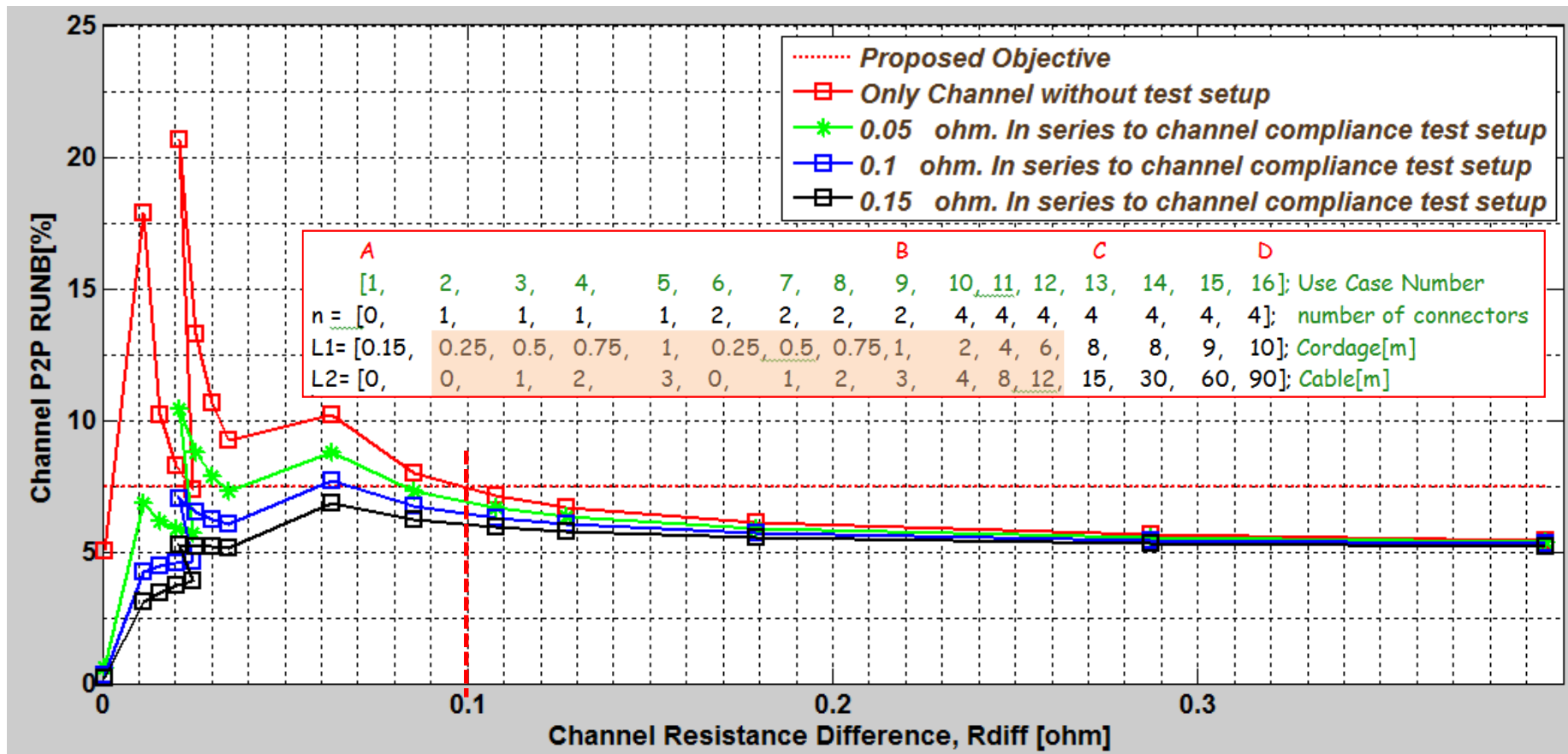

- All peaks of unrealistic use cases of the channel is located below $R_{diff}=0.1\Omega$.
- This is inline with the rational of 7.5% or 0.1Ω which ever is greater.
- The peaks are filtered when channel is tested with some minimum resistance.

Previous Work: Using setup that filters unrealistic use cases -2

Annex K22

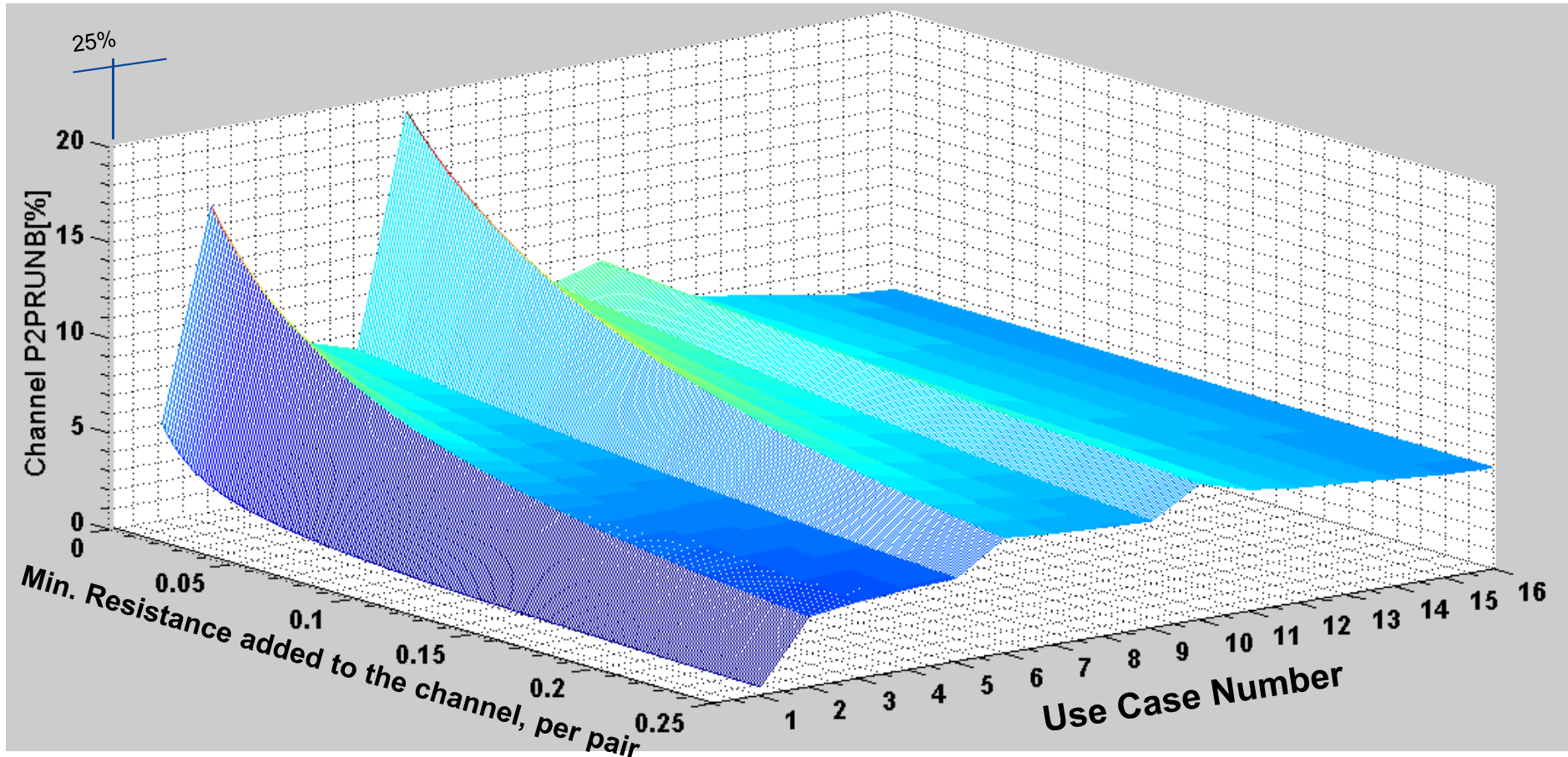

- Originally, the additional resistance added, was for channel compliance test to "filter" use cases that are considered as "not typical". Further work showed that the set up may not be required since realistic use case such B is falling into $R_{diff}=0.1\Omega$ max while the other realistic use case falls within the 7% proposed limit. More over below $R_{diff}=0.1\Omega$ max, the $C_P2PRUNB$ is bounded by connectors $R_{unb}=25\%$ per the worst case data used in this work

Previous Work: Using setup that filters unrealistic use cases -3

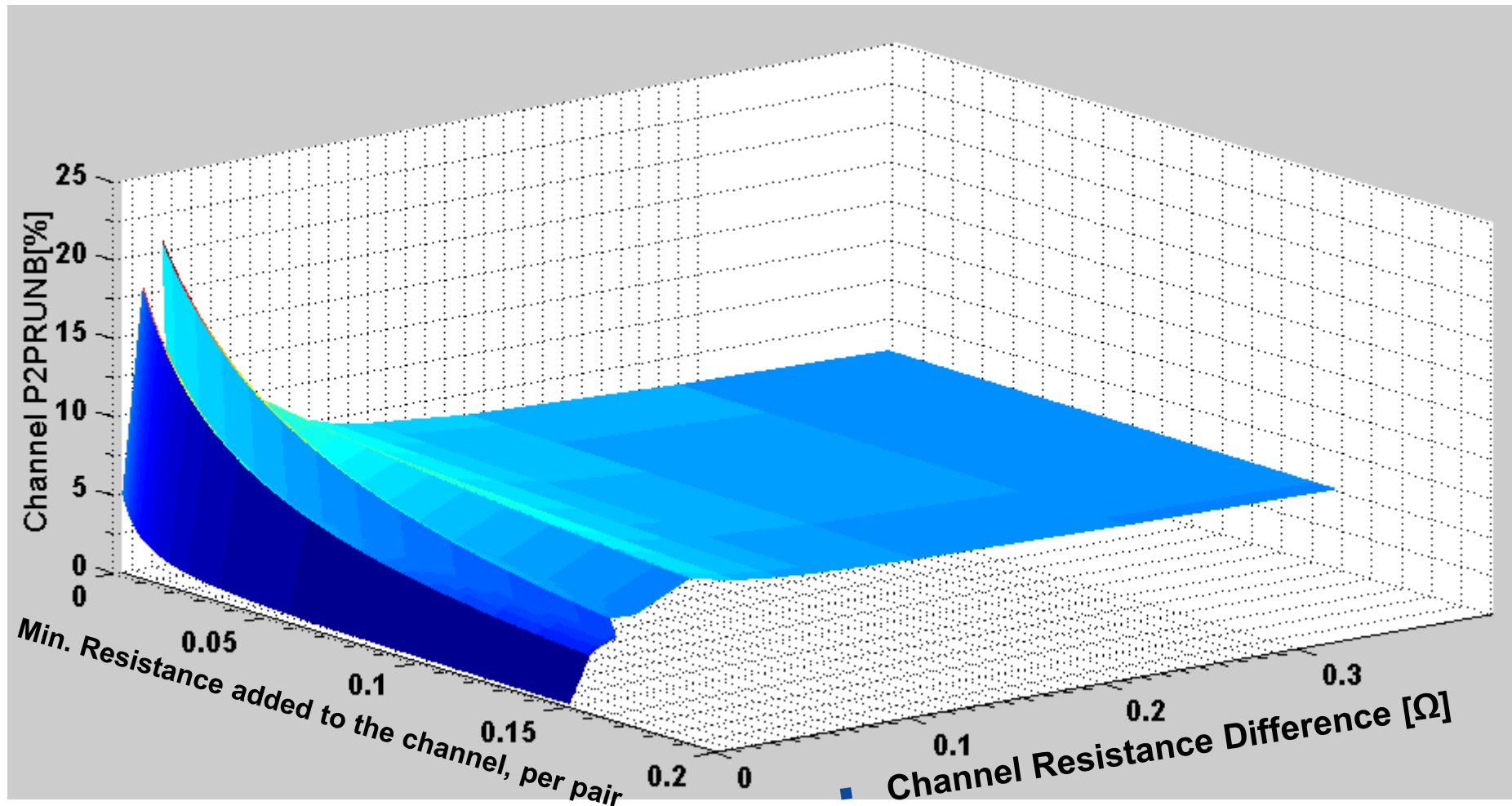

We can see that all peaks are located below 0.1 ohm requirement. As a result, setup may not be required. P2PRUNB and Rdiff cover all use cases.

Annex A

33.1.4.2 Type 1 and Type 2 channel requirement

Type 1 and Type 2 operation requires that the resistance unbalance shall be 3 % or less. Resistance unbalance is a measure of the difference between the two conductors of a twisted pair in the 100 Ω balanced cabling system. Resistance unbalance is defined as in Equation (33–1):

$$\left\{ \frac{(R_{\max} - R_{\min})}{(R_{\max} + R_{\min})} \times 100 \right\} \% \quad (33-1)$$

where

R_{\max} is the resistance of the channel conductor with the highest resistance
 R_{\min} is the resistance of the channel conductor with the lowest resistance

- The way channel pair (the differences between two wires in a pair) resistance unbalance was defined.

Source: Yair Darshan per
IEEE802.3-2012

Annex A2 - ANSI/TIA-568-C.2

■ Resistance unbalance of a channel

6.2.1 DC loop resistance

DC loop resistance for category 3, 5e, 6, and 6A channels shall not exceed 25 Ω . Refer to TIA TSB-184 for additional information on channel resistance related to guidance on delivering power.

6.2.2 DC resistance unbalance

DC resistance shall be measured for all channel conductors. DC resistance unbalance shall be calculated for each pair of the channel in accordance with equation (14) and shall not exceed the greater of 3% or 200 milliohms. DC resistance unbalance is not specified for category 3 channels.

$$Resistance_Unbalance_{pair} = \left(\frac{|R_1 - R_2|}{R_1 + R_2} \right) \cdot 100\% \quad (14)$$

where:

R_1 is the DC resistance of conductor 1.

R_2 is the DC resistance of conductor 2.

Source: Yair Darshan per
ANSI/TIA-568-C.2

Annex A3 - ANSI/TIA-568-C.2

■ Connecting Hardware requirements

6.8.1 DC resistance

DC resistance shall be measured in accordance with ASTM D4566 at $20\text{ }^{\circ}\text{C} \pm 3\text{ }^{\circ}\text{C}$ for all connecting hardware cable pairs.

NOTE – DC resistance is a separate measurement from contact resistance as specified in Annex A. Whereas DC resistance is measured to determine the connector's ability of transmit direct current and low frequency signals, contact resistance is measured to determine the reliability and stability of individual electrical connections.

Category 3 connecting hardware DC resistance between the input and the output connections of the connecting hardware (not including the cable stub, if any) used to terminate $100\ \Omega$ twisted-pair cabling shall not exceed $0.3\ \Omega$.

Category 5e, 6, and 6A connecting hardware DC resistance between the input and the output connections of the connecting hardware (not including the cable stub, if any) used to terminate $100\ \Omega$ twisted-pair cabling shall not exceed $0.2\ \Omega$.

6.8.2 DC resistance unbalance

DC resistance unbalance shall be calculated as the maximum difference in DC resistance between any two conductors of a connector pair measured in accordance with IEC 60512, Test 2a.

Category 3 connecting hardware DC resistance unbalance should not exceed $50\ \text{m}\Omega$. Category 5e, 6 and 6A connecting hardware DC resistance unbalance shall not exceed $50\ \text{m}\Omega$.

Source: Yair Darshan per
ANSI/TIA-568-C.2

Annex A4: What is the minimum channel length per TIA/ISO standards

- The fact is that the cabling channel models assumes some distance between the near end and the far end connecting hardware. As an example in 4 connector channel, the NEXT limits are based on two near end connectors and the far end connectors are not included.
- Look at the equation of the NEXT for the channel.
- For Return Loss worst case channels are developed based on models with assumed distances between connecting hardware.
- More inputs will be updated per Chris DiMinico contribution.

Annex A4 – Channel P2P Resistance Unbalance

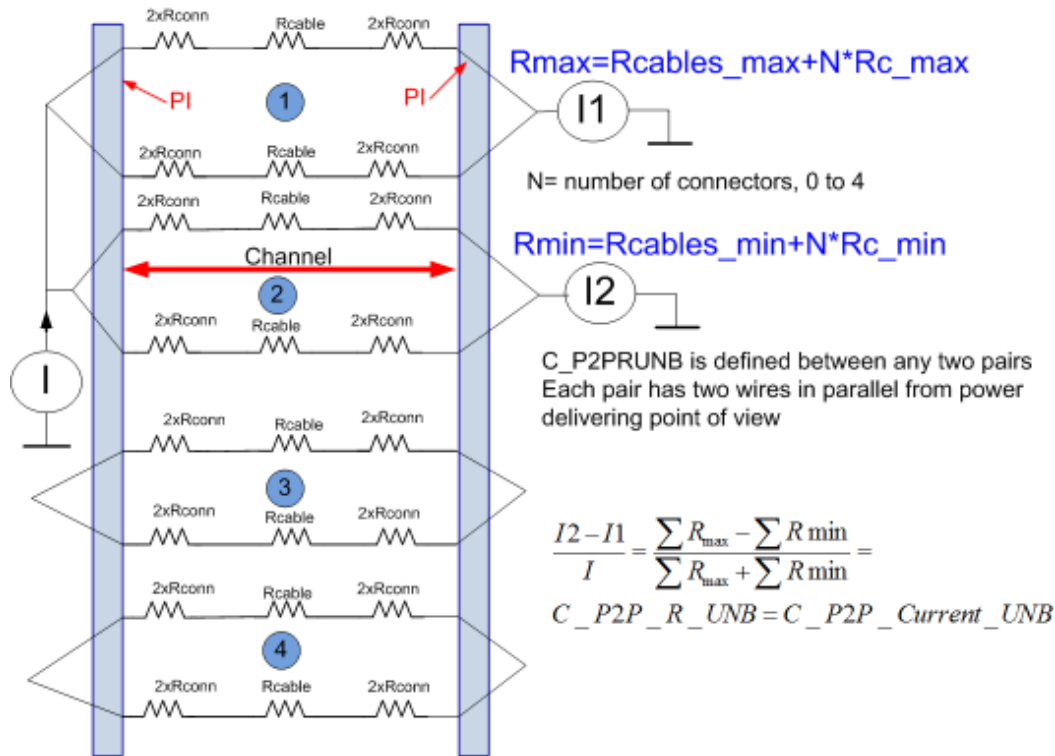

Channel_P2P_Current_DIFFERENCE =

$$= I_1 - I_2 = I \cdot \frac{\sum R_{max}}{\sum R_{max} + \sum R_{min}} - I \cdot \frac{\sum R_{min}}{\sum R_{max} + \sum R_{min}} = I \cdot \frac{\sum R_{max} - \sum R_{min}}{\sum R_{max} + \sum R_{min}}$$

As a result, Channel P2P Resistance or Current Unbalance ratio is::

$$\frac{I_2 - I_1}{I} = \frac{\sum R_{max} - \sum R_{min}}{\sum R_{max} + \sum R_{min}} = C_P2P_R_UNB = C_P2P_Current_UNB$$

Annex B: What is more important P2PRUNB or Current increase/pair due to at worst case conditions?

- To discuss the advantages that PD constant Power Sink allows us. Source: Yair Darshan
- Background material for considering (P2PRUNB in this slide refer to the end to end channel P2PRUNB):
 - Worst case End to End Channel Pair to Pair Channel Resistance Unbalance is at short cable (<100m).
 - At short cables PD voltage is higher that at 100m channel length and pair/port current is lower
 - Not only that the port current is lower, it is <600mA for Type 3 systems below TBD channel length.
 - **As a result, P2PCRUNB max may not an issue (pending the P2PCRUNB value).**
 - At 100m the P2PCRUNB is much smaller than at short channel
 - Resulting with less significant contribution to I_{bias} due to P2PCRUNB and as a result to OCL.
 - **This approach was validated in:**
http://grouper.ieee.org/groups/802/3/4PPOE/public/jul13/darshan_2_0713.pdf and requires further investigation for completing this work.

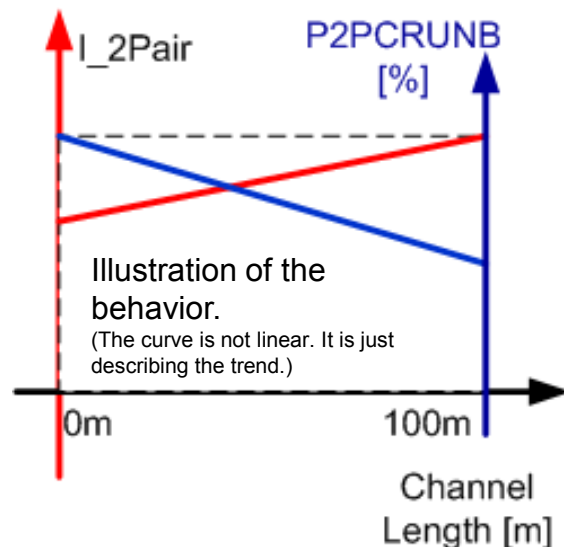

The answer is: In order to answer the question we need to check both data sets 1 and 2 in the worst case data base. We need to check the following equation:

$$0.5 \cdot (1 + \alpha_{(L=100m)}) \cdot I_{total_100m} < or > 0.5 \cdot (1 + \alpha_{(L=0.15m)}) \cdot I_{total_0.15m}$$

$$\alpha_{(L=100m)} = End2End_C_P2PRUN_at_100m$$

$$\alpha_{(L=0.15m)} = End2End_C_P2PRUN_at_0.15m$$

Source:

1. See link above, from July 2013.
2. Adhoc meeting #2, February 24, 2014.

Annex C1: Why we care for P2P resistance unbalance parameters

Source: Yair Darshan

- In 4P system:
- If $P2PRUNB > 0$ the PD current over each 2P will not be the same.
 - 51W PD with maximum total current of 1.2A, the current will split to $0.6A + 0.18A = 0.78A$ over the 2pairs with minimum resistance and 0.42A with the pair with maximum resistance.
- In general: The pair with the highest current will be:
 $I_t * (1 + P2PRUNB) / 2$
 - This will require to overdesign the magnetics for high P2PRUNB values.
 - Watching limits of connector pins, PCB traces and power components on the DC current path at PSE and PD and overdesign accordingly.
 - So there is interest to have components with lower P2PRUNB along the channel as possible by cost and manufacturability limitations to result with lower End to End Pair to Pair RUNB.

Annex C2: Why we care for P2P resistance unbalance parameters

- Other concerns was how it will affect on PD minimum available power for a 60W system (two times the 802.3at power). The decision was that for our current data base we can supply 49W for the PD (instead of 51W). See 802.3bt objective.
 - This was done by calculating what will be the power at the PD if we keep maximum 600mA at the pair in order not to cause issues to Type 2 component/ devices that can work with 4P
- Other concern was if P2PRUNB will increase power loss on the cable. We show that now it will not. Moreover we show that if P2PRUNB increased, the power loss is decreased.

$$Trise = 0.5 \cdot N \cdot It^2 \cdot R_{loop_max} \theta_N \cdot [1 - P2PCRUNB]$$

- See: http://www.ieee802.org/3/4PPOE/public/nov13/darshan_02_1113.pdf for more details.

Source: Yair Darshan

Annex D1: Calculations of CP2PRUNB with constant power sink model and the effect on transformer bias current.

Equation	Symbol	Units	Channel Length	
			1m	100m
End to End Pair to Pair Channel Resistance Unbalance: $CP2PRUNB = \frac{\sum R_{max} - \sum R_{min}}{\sum R_{max} + \sum R_{min}}$	CP2PRUB	-	0.26	0.112
	I	A	1.02	1.2
	I/2	A	0.51	0.6
I*CP2PRUNB	DI	A	0.2652	0.1344
I*CP2PRUNB/2	DI/2	A	0.1326	0.0672
I*(1+CP2PRUNB)/2	I _{max} =(I+di)/2	A	0.643	0.667
I*(1-CP2PRUNB)/2	I _{min} =(I-di)/2	A	0.377	0.533
I _{bias} =3%*I _{max} /2		A	0.0193	0.02
Sanity Check	I	A	1.02	1.2
Effect on I _{bias} of transformer: 3%*(I _{max} -0.6)/2	d(I _{bias})	mA	0.639	1.008

Source: Yair Darshan

Annex D2: Affecting parameters on Transformer Ibias

- PSE Rsense and Rdson are out of the loop for pair unbalance
 - They affect only on P2P unbalance
 - Which affect Iport (increase or decrease) which affect Ibias by $3\% * (I_{port_max} - I_{port_nominal})$
- How to reduce Ibias?
 - Adding Rballast on transformers reduces Ibias directly
 - Defining minimum cable length reduces P2PRUNB_max. The effect on Ibias is $3\% * (I_{port_max} - I_{port_nominal})$.
 - Adding in PD ballast resistors (cost effective in PD and not in PSE)
 - May not be needed for PD power below TBD.
 - Using matched diode bridges (in terms of Vf differences and dynamic behavior), Reduces P2PRUNB and as a result, the current unbalance. Is reduced. Due to the complex nature of diodes, more research is needed.

Source: Yair Darshan

Annex E1 – Connector and Cabling standard data

- Summary of resistivity and resistance unbalance (Source Wayne Larsen)
- specifications in TIA cabling standards
- Resistivity of cable and “cordage” from cabling standards
- – Cable DC resistance is 9.38 Ohms / 100 meters, ANSI/TIA-568-C.2, 6.4.1, page 58. Cat 5e, 6, and 6A are all the same.
- – Cordage DC resistance is 14 Ohms / 100 meters, ‘568-C.2, 6.6.1,page 74. Cat 5e, 6, and 6A are all the same.
- – Cable and cordage resistance unbalance with a pair is 2.5 % per IEC 61156-1, ‘568-C.2-1 6.4.2 page 58. All categories are the same.
- – Cable and cordage resistance unbalance between pairs is not specified, but has been studied and found to be less than 5 %.
- – Connectors are allowed 200 milliohms resistance and 50 milliohms resistance unbalance between any conductor. They actually have much less resistance.
- Yair Darshan notes:
- These values are maximum values, pre PoE standard.
- There are no specifications for minimum values as needed for P2P unbalance analysis. As a result, to cover both angles of P2PRUNB at short and long channel, maximum 12.5Ω channel was used for generating maximum pair current and channel with horizontal cable resistivity of 0.066 Ω/m was used to generate worst case P2PRUNB. **Later this number was updated to 0.079 Ω/m to include twist rate effect.**
- As for connectors: less than 0.06 Ω connector resistance was used. See worst case data base for

Annex E2 – Connectors terms.

- **Source Yakov Belopolsky / BEL**
- The term used in the connector industry is LLCR (Low Level Contact Resistance)- Bulk R_{LLCR-B}
- Low Level Contact Resistance (LLCR-Bulk) consists of four components
 - Plug Conductor Resistance R_{CR}
 - Plug Blade/Conductor Contact Resistance R_{PBCR}
 - Plug Blade/Jack Wire Contact Resistance or TRUE LLCR R_{CRTRUE}
 - Jack Wire Resistance R_{JWR}
- $R_{LLCR-B} = R_{CR} + R_{PBCR} + R_{CRTRUE} + R_{JWR}$
- However, it is easy to measure and subtract $(R_{CR} + R_{PBCR})$ from the Bulk so many connector vendors use the Contact resistance $(R_{CRTRUE} + R_{JWR})$
- **A typical differential between two types measurements is less than 20 milliohm**
- The reason is that the $(R_{CRTRUE} + R_{JWR})$ is affected by environmental exposure and defines the quality of the connector design separately from the plug blade termination quality

Annex E3: Connector data from vendors datasheet

Source: Yair Darshan

	Vendor	Resistance per datasheet
CAT6	A	30 milliohm max ,Jack only ¹
CAT6	B	35 milliohm max ,Jack only ¹
CAT6	C	30 milliohm max ,Jack only ¹

1. It is per datasheet so actual values are lower.

Source: Yair Darshan

Annex E4 - Connector data – Source BEL

http://www.ieee802.org/3/at/public/2006/07/belopolsky_1_0706.pdf slide 22.

30milliohm connector resistance shown by BEL

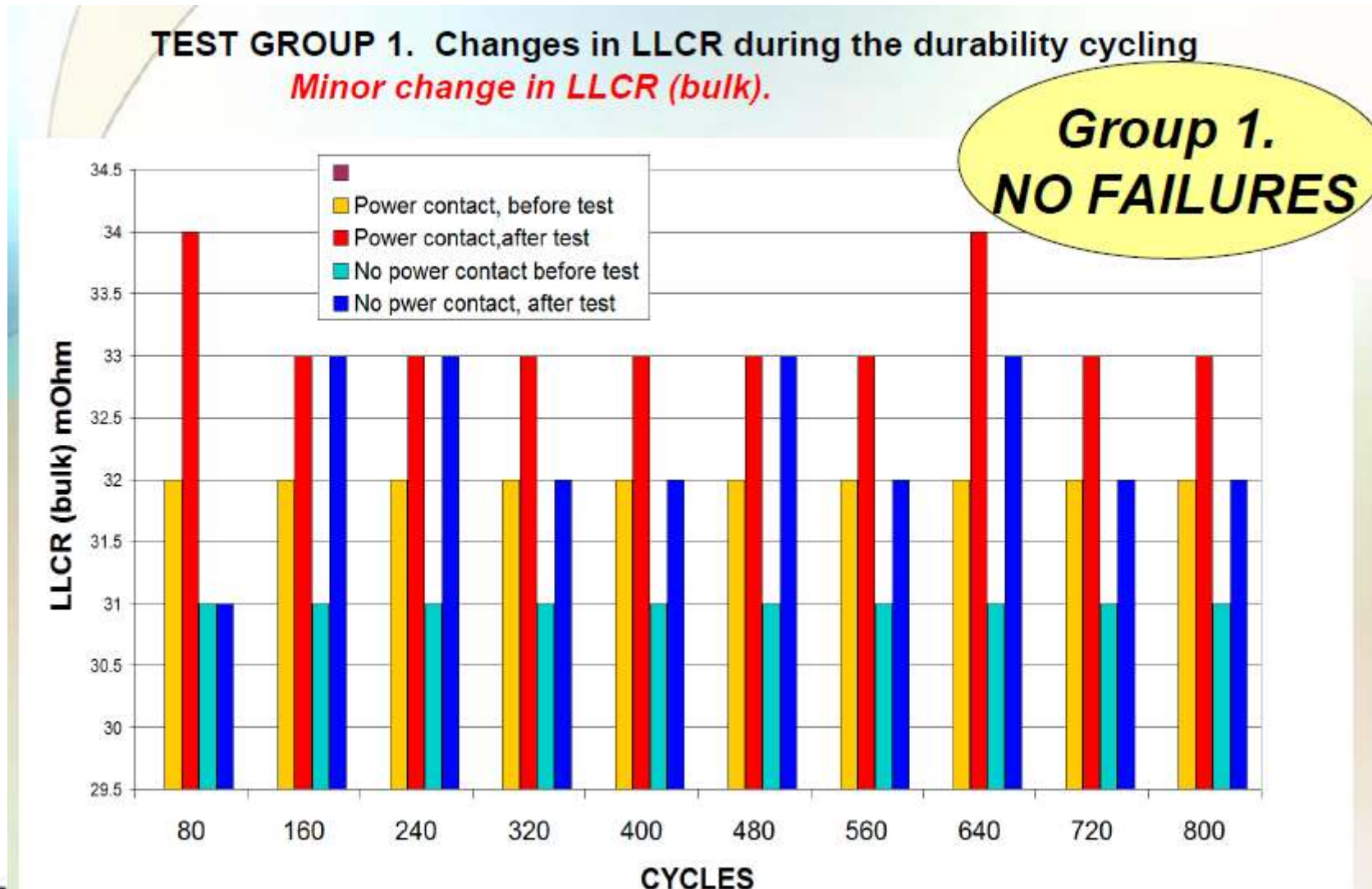

Annex E5: Connectors test data

- Source: Microsemi
- Each number in the table is the average resistance of all pins from end to end (Plug and Jack) for each connector.

Connector #	Vendor A	Vendor B	Vendor C	Vendor D	
	CAT6	CAT6	CAT6A	CAT6A	
1	45	43	39	42	45
2	43	43	40	49	46
3	48	42	40	40	39
4	48	46	42	39	44
5	43	45	39	38	47
6	46	39	43	50	44
7	45	42	39	38	43
8	49	46	42	41	44
9	46	45	39	44	45
10	42	45		51	44
11	43	46		44	43
12	43	43		50	39
13		46		54	40
14		42		39	47
15		46		55	42
16		46		51	48

	Vendor A	Vendor B	Vendor C	Vendor D
Average	45.08	44.06	40.33	44.53
Max	49	46	43	55
min	42	39	39	38
Rdiff	7	7	4	17

Average connector resistance	43.50
Max	55
Min	38
Rdiff	17

- All connector resistance: 55milliΩ max.**
 - Vendors approve 60milliΩ max.
 - There are high quality connector that get to 30milliΩ.
 - The average resistance of these samples: 43.5milliΩ
- Additional Information (not shown from the tables attached):**
 - Within a connector, **pair to pair resistance difference** ≤ 20milliΩ was confirmed.
 - Most results were below 15milliΩ, therefore this number chosen to be at the worst case data base table.
 - Simulations will be done for 15 and 20 milliohms as well.

Source: Yair Darshan

Annex E6: Connectors test data

http://www.vtiinstruments.com/Catalog/Technotes/RJ-45_Excels_For_Stria_Gage_Connection.pdf

- See above link page 12.
- 45milliohm connector resistance of 40 connector samples.
- See page 13 at the above link for connector resistance over temperature

Source: Yair Darshan.
Based on the above link.

Annex F – End to End P2P Resistance Unbalance Model

General Channel Model and its components that we have used.

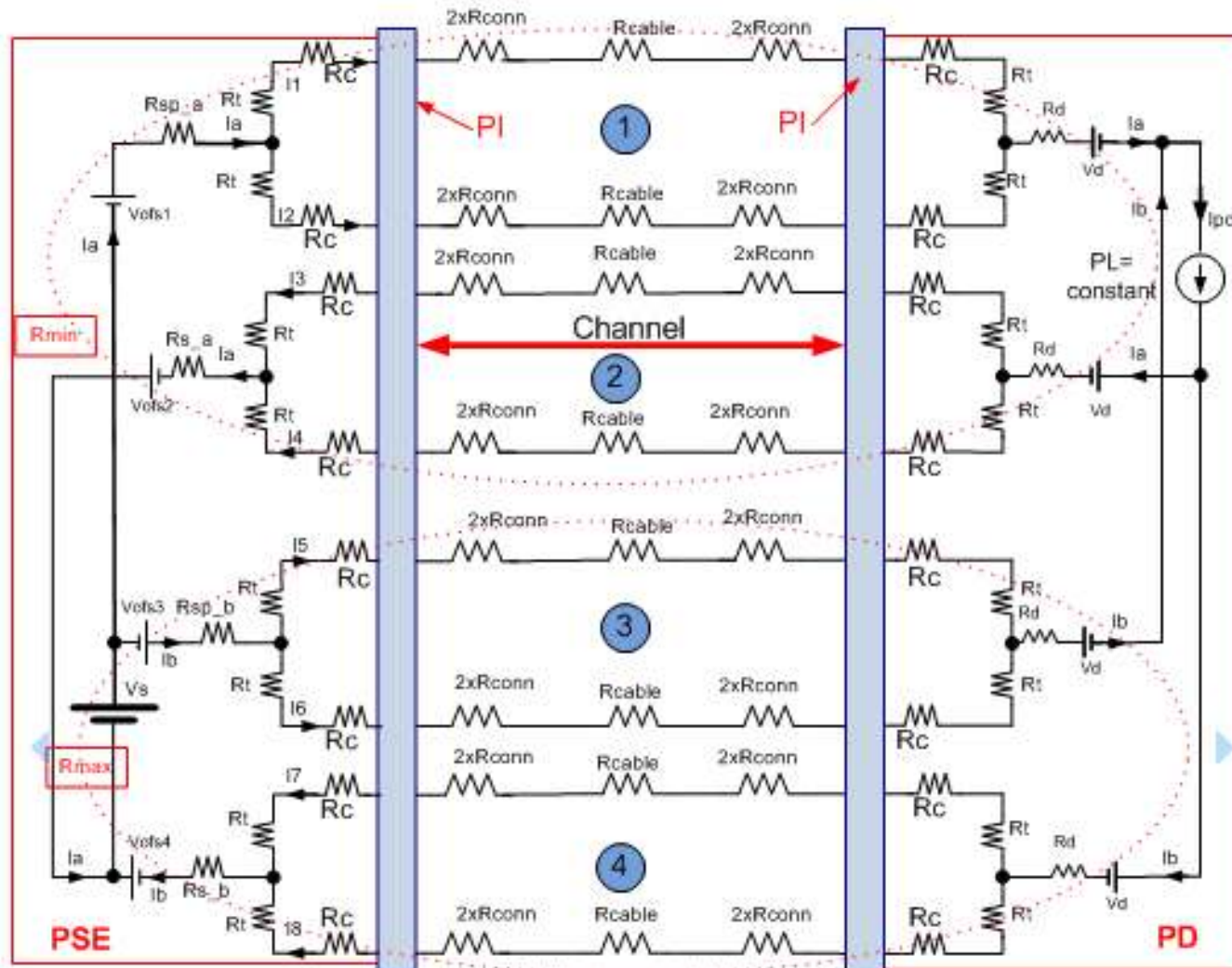

Notes for the general Model:

1. Total end to end channel connectors is 6 max.
2. The formal channel definition is marked in red arrow and is with up to 4 connectors.
3. Our work addresses also the internal application resistance of known components that are used
4. In simulations, pairs 1 and 2 components were set to minimum and pairs 3 and 4 were set to maximum values. See simulation results on previous meetings
5. **Vofs1/2/3 and 4 was added. To update the group. July 3, 2014.**

Source: Yair Darshan and Christian Beia

Annex G1:Worst Case Data Base (updates) -1

See notes to the table in next slide

#	Parameter	Data set 1	Data set 2
1	Cordage resistivity ¹	0.14Ω/m	
		0.09262Ω/m for AWG#24 for worst case analysis	
2	Horizontal cable resistivity option 1 ²	11.7Ω/100m=(12.5Ω - 4*0.2Ω) / 100m which is the maximum resistance resulting with maximum lport.	7.92Ω/100m (CAT6A, AWG23) This is to give us maximum P2P Runb
3	option 2 ³	0.098Ω/m.	
4	Unbalance parameters	<ul style="list-style-type: none"> • Cable Pair resistance unbalance: 2%. Channel pair resistance unbalance: 3% • Cable P2P Resistance Unbalance: 5%. Channel P2P Resistance Unbalance: 0.2Ω/6% max TBD. 	
5	Channel use cases to check. See figure 1 for what is a channel.	A. 6 inch (0.15 m) of cordage, no connectors. B. 4 m channel with 1 m of cordage, 3 m of cable, 2 connectors C. 23 m channel with 8 m of cordage, 15 m of cable, 4 connectors D. 100m channel with 10 m of cordage, 90 m of cable, 4 connectors	
6	End to End Channel ⁶	The Channel per figure 1 + the PSE and PD Pls.	
7	Transformer winding resistance	120mOhm min, 130mOhm max	
8	Connector resistance ⁸	40mOhm min, 60mOhm max	30mOhm min, 50mOhm max
9	Diode bridge ⁹	Discreet Diodes: 0.39V+0.25Ω*Id min; 0.53V+0.25Ω*id max. (TBD)	
10	PSE output resistance ¹⁰	0.25+0.1 Ohm min, 0.25+0.2 Ohm max	0.1+0.05 Ohm min, 0.1+0.1 Ohm max

Ad-hoc response, June 24, 2014. Adhoc accept this table

Source: Yair Darshan, Christian Beia, Wayne Larsen



Annex G2: Worst case data base- Notes. -2

1	Per standard. It is maximum value for solid and stranded wire. The maximum value is close to AWG#26 wire resistance/meter including twist rate effects. See annex E1 . Due to the fact that patch cords may use AWG#24 cables with stranded (for mechanical flexibility) or solid wire (for improved performance), we will use the AWG#24A for worst case analysis as well. Cordage with AWG#24 wire has 0.0842Ω/m for solid wire and with 10% twist rate it will be 0.09262 Ω/m.
2	We need both data sets (data set 1 and data set 2) to find where is the worst condition for maximum current unbalance. See Annex B curve and data showing that at short channel we get maximum P2PRUNB but it may has less concern to us since the current is lower. We need to do all use cases calculation to see where is the maximum current over the pair; at short channel or long channel. The CAT6A cable with AWG#23 has 0.066 Ω/m. Including 12% increase on cable length due to twist rate, the effective cable resistance per meter will be 1.12*6.6 Ω/100m= 0.0792 Ω/m.
3	Standard definition per Annex E1. We will check how results will be differ when AWG#23 is used for worst case results (lower resistance than standard definition for horizontal cable which is a maximum value.
4	
5	
6	PSE PI and PD PI includes: connector, transformer, resistors. PD PI includes diode bridge.
7	
8	Connector resistance was changed since the difference (60-30) milliohm is not representing Rdiff, it is representing maximum and minimum results of connector resistance of different connectors. To correct it, we change the numbers according to inputs from connector vendors and measured data. See Annex E1-E6 for confirmation .
9	Vf and Rd are worst case numbers of discrete diode which there is no control on Vf and Rd. It needs more investigation to verify that we are not over specify. (Christian is checking it). Normally match components (e.g. matched two diode bridges) are used for 4P operation. Any how ,PD PI spec. will eventually set the requirement.
10	PSE output resistance e.g. $R_{s_a/b} = R_{sense} + R_{dson}$ in addition to winding resistance. See model I Annex F for reference.

Adhoc response, June 24, 2014. Adhoc accept this table

Source: Yair Darshan and Christian Beia



Annex G3: Deciding on Channel components data

Connector data combinations that don't make sense.

#	Rmax milliΩ	Rdif milliΩ	Rmin milliΩ	Notes
1	201	-	-	200milliΩ max, standard
2	-	51	-	50milliΩ max, standard
3	60	50	10	Meets the standard however doesn't make sense to have 71.4% P2PRUNB.
4	61	-	-	Field results, 60milliΩ max
5	-	30	-	Field results, 20milliΩ max

Connector data combinations that make sense.

6	60	20	40	OK
7	50	20	30	OK for worst case.

- Connector vendors: connector resistance range of different connectors for worst case lowest numbers: 0.03Ω to 0.06 Ω. (Standard is 200milliohm max and Rdiff=50milliohm max which is not helping us).
- With in a connector (pin to pin or pair to pair), the difference between Rmax and Rmin (=Rdiff) is 0.02Ωmax, Typically it is not more than 0.015Ω. (instead 0.03Ω).
- As a result, for worst case calculation we will use for connectors:
 - Connector Rmax=0.05Ω, Connector Rdiff=0.02Ω max.
- Cordage: 0.14 Ω/m per standard. Cable: 0.0792Ω/m for CAT6A AWG#23 cable for worst case analysis.

Adhoc response, June 24, 2014. Adhoc accept this table

Source: Yair Darshan

Annex G4: Minimum resistance existing in PSE and PD Pis, Example based on Annex G1 database.

- Calculating existing minimum resistance in PSE and PD PI.

All numbers calculated for a pair = two wires in parallel.			
PSE PI minimum resistance range			
	Max	Min	
Connectors	0.015	0.015	0.03 ohm per connector divided by 2
Diodes	0.25	0	If AC disconnect then higher e.g. 0.25 ohm
Transformers	0.06	0	For 1000BT and up, otherwise 0. transformer winding from center tap to outer leg=0.12ohm/2
EMI Filters	0.1	0.1	
PCB traces	0.01	0.01	
Total	0.435	0.125	
PD PI minimum resistance range			
	Max	Min	
Connectors	0.015	0.015	0.03 ohm per connector divided by 2
Diodes	0.25	0.05	If active diodes are used (Mosfets) the resistance is lower (*)
Transformers	0.06	0	For 1000BT and up, otherwise 0. transformer winding from center tap to outer leg=0.12ohm/2
EMI Filters	0.1	0.1	
PCB traces	0.01	0.01	
Total	0.435	0.175	
Total minimum PSE and PD resistance per pair		0.125 + 0.175 = 0.3	

Source: Yair Darshan



Annex J1-Acronyms used in the ad-hoc activity

- **(1) Pair resistance unbalance** : Is the resistance unbalance between two wires in the same pair as specified by IEEE802.3 and other standards. This is 2% for cable and 3% maximum for the channel. Channel is a 4 connector model (cables and connector only).
- **(2) Pair to Pair resistance unbalance**: is the resistance unbalance between two wires of the same pair connected in parallel to another two wires of other pair connected in parallel. It is 5% for a cable.

(The resistance of the two wires of the pair is know also as the common mode resistance of the pair)

- **(3) End to End channel pair to pair resistance unbalance** it is the 26.2% (TBD) worst case calculation on a worst case data base that we have generated. The 26.2% (TBD) was calculated at 20degC. The channel is including components at PSE PI and PD PI that affects the whole end to end channel.
- **(4) PSE PI Pair to Pair resistance unbalance** is the P2P DC Common Mode PSE Output Resistance Unbalance measured at the PSE PI and include PI interface circuitry such RDSON, Current sense resistor, equipment connector, magnetic winding resistance. This is included in the " end to end channel resistance unbalance" and need to be extracted from it to be separate definition for PSE PI P2PRUNB.
- (4.1) PSI PI Pair to Pair voltage difference is the P2P DC Common Mode PSE Output Voltage Difference measured at the PSE PI under TBD conditions.

Source: Yair Darshan



Annex J2-Acronyms used in the ad-hoc activity

- **(5) PD PI Pair to Pair resistance unbalance** is the P2P DC Common Mode PD input Resistance Unbalance measured at the PD PI and include PI interface circuitry such Diode bridge voltage offset and dynamic resistance, equipment connector, magnetic winding resistance. This is included in the "end to end channel resistance unbalance" and need to be extracted from it to be separate definition for PD PI P2PRUNB.
- **(5.1) PD PI Pair to Pair voltage difference** is the P2P DC Common Mode PD input Voltage Difference measured at the PD PI under TBD conditions.
- **(6) Channel Pair to Pair resistance unbalance** is the P2P resistance unbalance of the cables and 4 connector model. This need to be excreted from the " end to end channel resistance unbalance" and specified separately.
- So (PSE PI +Channel + PD PI)p2prunb all together is 26.2% (TBD).
- Items 4,5 and 6 will be specified in the standard, (item 2 is covered by item 6).
- Meeting #4: Adhoc response: ok. Meeting #5: To discuss changes in RED. Done.

Source: Yair Darshan

Annex K: Same-Pair Current Unbalance vs. DC bias on Transformers

- Source: Dinh, Thuyen, Pulse.
- Current unbalance on cable pair: $\Delta I = I_1 - I_2$
- This ΔI is the net current difference between the 2 half windings of the cable side of the transformer, it only flows in one of the 2 half windings
- Since transformers are tested with bias current injected through both windings, as specified in clause 25 (sub-clause 9.1.7 of ANSI X3:263:199X), a DC bias of $(\Delta I/2)$ injected into both windings will produce the same DC flux as that produced by ΔI flowing through one half winding.
- Transformers are, therefore, tested with $(\Delta I/2)$ DC bias current to simulate current unbalance of ΔI .

Annex L1: What are the options for complete specification for unbalance PSE PI and PD PI models parameters



Source: Yair Darshan. June 25, 2014

- Current unbalance is a function of Voltage unbalance and resistance unbalance between pairs.
 - These are the only parameters that affect the current unbalance and as a result the maximum pair current due to the unbalance situation.
- For simplicity let's assume Voltage unbalance is zero. We will address the effect of Voltage difference later.
- By definition, the current unbalance between any two pairs is:

$$I_{unb} = |I_1 - I_2| = I_t \cdot \frac{\sum R_{max}}{\sum R_{max} + \sum R_{min}} - I_t \cdot \frac{\sum R_{min}}{\sum R_{max} + \sum R_{min}} = I_t \cdot \left(\frac{\sum R_{max} - \sum R_{min}}{\sum R_{max} + \sum R_{min}} \right)$$
$$\frac{I_{unb}}{I_t} = \left(\frac{\sum R_{max} - \sum R_{min}}{\sum R_{max} + \sum R_{min}} \right) = Runb = Iunb$$

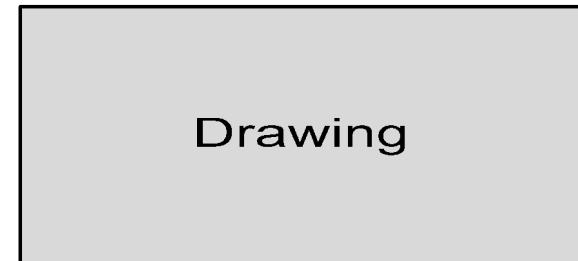

- Since we are discussing P2P unbalance the Runb and Iunb is between Pair to Pair and the sum of R1 and the sum of R2 represents two wires in parallel including all components connected to each wire.
- The above equations are the same for PSE PI, Channel and PD PI unbalance. The difference is the content of R1 and R2 e.g. for channel it is just cables and connectors. For PSE and PD PIs it contains additional other components such MOSFETs, Diodes, Transformers etc.

Annex L2: What are the options for complete specification for unbalance PSE PI and PD PI models parameters

- The maximum pair current is function of the total End to End Channel Resistance and Voltage Unbalance.
- The PSE PI and PD PI are affecting I_{max} at short and long channels.
- By definition for maximum pair current I_{max} as function of P2PRUNB and P2P Voltage Difference of the system from end to end:

$$I_{max} = \frac{It}{2} + \frac{It \cdot E2E_P2PRUNB}{2} = \frac{It \cdot (1 + E2E_P2PRUNB)}{2}$$

$$I_{max} = \frac{It \cdot (1 + E2E_P2PRUNB)}{2} = \frac{It \cdot \left[1 + \left(\frac{\left(\sum \frac{PSE}{R_{max}} - \sum \frac{PSE}{R_{min}} \right) + \left(\sum \frac{PD}{R_{max}} - \sum \frac{PD}{R_{min}} \right) + \left(\sum \frac{CH}{R_{max}} - \sum \frac{CH}{R_{min}} \right)}{\sum \frac{PSE}{R_{max}} + \sum \frac{PD}{R_{max}} + \sum \frac{CH}{R_{max}} + \sum \frac{PSE}{R_{min}} + \sum \frac{PD}{R_{min}} + \sum \frac{CH}{R_{min}}} \right)}{2} \right]}{2}$$

$$I_{max} = \frac{It \cdot (1 + E2E_P2PRUNB)}{2} = \frac{It \cdot \left[1 + \left(\frac{\sum \frac{PSE}{R_{diff}} + \sum \frac{PD}{R_{diff}} + \sum \frac{CH}{R_{diff}}}{\sum \frac{PSE}{R_{max}} + \sum \frac{PD}{R_{max}} + \sum \frac{CH}{R_{max}} + \sum \frac{PSE}{R_{min}} + \sum \frac{PD}{R_{min}} + \sum \frac{CH}{R_{min}}} \right)}{2} \right]}{2}$$

- **The PSE PI P2PRUNB can be defined in similar way by similarity.**
- **Note: PSE PI P2PRUNB is not equal to E2E_CPWPRUNB nor to PD PI P2PRUN. It requires additional mathematical procedure to find this parameters so it will be equal to the E2E_CP2PRUNB target.**

Source: Yair Darshan



Annex L3: What are the options for complete specification for unbalance PSE PI and PD PI models parameters

- We can see that I_{max} is function of R_{max} and R_{min} and $R_{diff}=R_{max}-R_{min}$

$$I_{max} = \frac{I_t \cdot (1 + E2E_P2PRUNB)}{2} = \frac{I_t \cdot \left[1 + \left(\frac{\sum R_{diff}^{PSE} + \sum R_{diff}^{PD} + \sum R_{diff}^{CH}}{\sum R_{max}^{PSE} + \sum R_{max}^{PD} + \sum R_{max}^{CH} + \sum R_{min}^{PSE} + \sum R_{min}^{PD} + \sum R_{min}^{CH}} \right) \right]}{2}$$

- From the above, PSE PI P2PRUNB **upper limit** can be extracted and it will have the same effect on I_{max} with the same exact concept.

$$PSE_PI_P2PRUNB = \frac{\sum R_{diff}^{PSE}}{\sum R_{max}^{PSE} + \sum R_{max}^{PD} + \sum R_{max}^{CH} + \sum R_{min}^{PSE} + \sum R_{min}^{PD} + \sum R_{min}^{CH}}$$

$$PSE_PI_P2PRUNB = \frac{(k + \alpha) \cdot \sum R_{diff}^{PSE}}{\sum R_{max}^{PSE} + \sum R_{min}^{PSE} + \beta} = \frac{\sum R_{diff_new}^{PSE}}{\sum R_{max_new}^{PSE} + \sum R_{min_new}^{PSE}}$$

- The terms k , a and b are used to transform the true PSE PI P2PRUNB to PSE PI P2PRUNB as stand alone function.
- Now we can see what are the necessary unbalanced properties that are needed to uniquely specify the PSE PI?

Source: Yair Darshan

Annex L4: What are the options for complete specification for unbalance PSE PI and PD PI models parameters

$$PSE_PI_P2PRUNB = \frac{\sum R_{diff_new}^{PSE}}{\sum R_{max_new}^{PSE} + \sum R_{min_new}^{PSE}} = \frac{\sum R_{max_new}^{PSE} - \sum R_{min_new}^{PSE}}{\sum R_{max_new}^{PSE} + \sum R_{min_new}^{PSE}}$$

$$I_{max} = 0.5 \cdot I_t \cdot \left(1 + \frac{\sum R_{diff_new}^{PSE}}{\sum R_{max_new}^{PSE} + \sum R_{min_new}^{PSE}} \right)$$

- Conclusions: In order to limit I_{max}_pair you must have in addition to voltage difference and maximum load current I_t, two additional parameters.
- First and foremost observation: I_{max} is equation with 3 parameters. Total current, I_t is given. We need two variables to solve equation with two parameters
- So specifying only R_{diff} and V_{diff} for PSE PI or PD PI will not work. It leads to interoperability issues. (one parameter is loose..)

Source: Yair Darshan

Annex L5: What are the options for complete specification for unbalance PSE PI and PD PI models parameters

- I_{max} is direct function of PSE PI RUNB and Channel and PD parts.
- The transformed PSE_PI_P2PRUNB_new control I_{max} .

$$I_{max} = 0.5 \cdot I_t \cdot (1 + PSE_PI_P2PRUNB_new) = 0.5 \cdot I_t \cdot \left(1 + \frac{\sum R_{diff_new}^{PSE}}{\sum R_{max_new}^{PSE} + \sum R_{min_new}^{PSE}} \right)$$

- If we specify PSE PI by only R_{diff} and V_{diff} we will have the following interoperability issues:

- Examples:

- $R_{diff} = R_{max} - R_{min} = 0.2 = X$:
 - $P2PRUNB = (0.2 - 0) / (0.2 + 0) = 100\%$
 - $P2PRUNB = (0.23 - 0.03) / (0.23 + 0.03) = 77\%$
 - $P2PRUNB = (0.3 - 0.1) / (0.3 + 0.1) = 50\%$
 - $P2PRUNB = (1 - 0.8) / (1 + 0.8) = 11\%$

Interoperability Issue:
Different UNBALANCE
For the same R_{diff} resulting
With different I_{max} for the
Same channel and PD

Source: Yair Darshan

Annex L6: What are the options for complete specification for unbalance PSE PI and PD PI models parameters

Source: Yair Darshan

Option	PSE PI P2PRUNB	Rmax	Rmin	Rdiff	Notes
1	Yes	-	-	-	1. Ratio. Fully implementation independent . 2. Need two parameter to solve equation with two variables. Need more research to verify completeness.
2	-	Yes	Yes	-	1. Complete solution. 2. Not flexible, Implementation dependent.
3	Yes	Yes			1. Complete solution. 2. Not flexible, Implementation dependent. Problem to limit Rmax
4	Yes	No	Yes	-	1. Complete solution. 2. Rmin is exists any way. 3. Not fully Implementation in dependent but tolerable.
5	Yes	NO	NO	YES	1. Complete solution. 2. Implementation dependent.
6	NO	NO	NO	YES	1. Not complete 2. Implementation dependent 3. Interoperability issues

Annex L7: Why Channel Rdiff=Delta R is not sufficient to define channel unbalance.

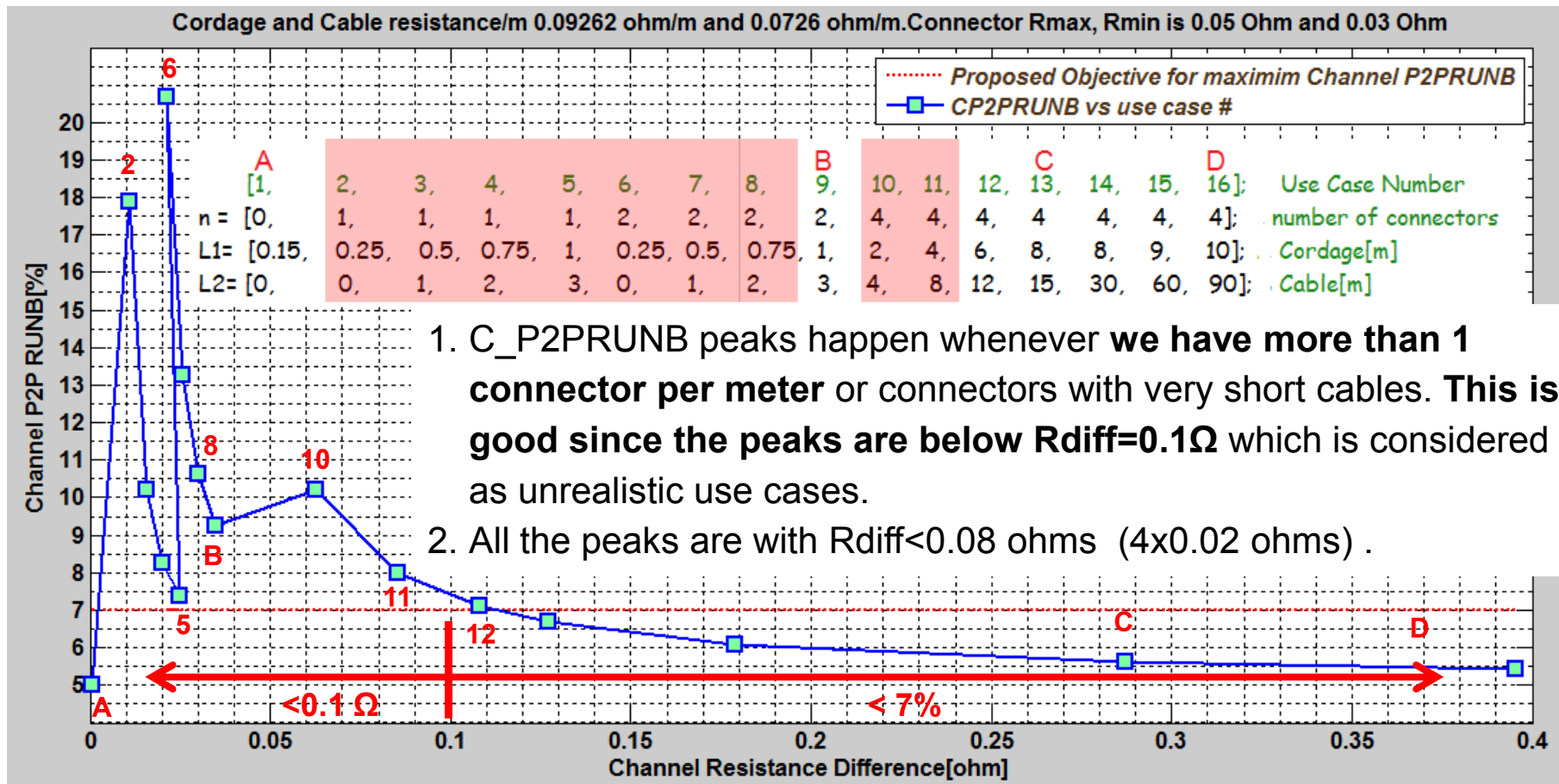

- The mathematical basics are the same as explained for PSE and PD PIs. See Annex L1-L6 for details. In the channel it is further more obvious per next slide.

Source: Yair Darshan

Annex L8: Why Channel Rdiff=Delta R is not sufficient to define channel unbalance.

- If we will specify Channel P2P RUNB by its $R_{max}-R_{min}=R_{diff}=0.1\Omega$ (or any number) property only we will end with the following undesired results:
 - (a) At long channel (high resistance) the unbalance is converging to lowest possible value. It is bounded by the P2PRUNB[%] property which is much lower than the connectors unbalance property.
 - (b) At short channel when resistance is low, the P2PRUNB property is bounded by the connectors R_{max} , R_{min} which results with 25% unbalance for $R_{max}=0.05\Omega$, $R_{min}=0.03\Omega \rightarrow R_{diff}=0.02\Omega \rightarrow (50-30)/(50+30)=25\%$
- So it is obvious that best and optimized performance will be achieved with two properties needed for the channel: P2PRUNB and Rdiff.

Source: Yair Darshan

Annex M: How we address P2PRUNB vs Temperature

- Adhoc has recommended the following approach (meetings 5,6,7)
 - How to handle PSE PI, PD PI Pair to Pair unbalance parameters and Channel P2RUNB as function of temperature?
 - Adhoc response:
 - Use PSE PI, PD PI pair to pair Unbalance parameters and Channel P2PRUNB that was calculated at 20°.
 - Set it as the number to meet without saying at what temperature it is.
 - Vendors will have to assure that they meet it at their operating temperature range spec.
 - How they will do it, we don't care. The rest is per 33.7.7.

Ad-hoc response, June 10, 2014. Ad hoc agrees to set temperature of P2PUNB numbers at 20degC.

Annex P: The value of channel maximum Rdiff

- On May 2014 we vote for the following base line text highlighting the TBD areas.
 33.1.4.3 Channel Requirement for Pair to Pair Resistance unbalance
 4P pair operation requires the specification of resistance unbalance between each two pairs of the channel, not greater than **200 milliohms** or **6%(TBD)** which ever is greater. Resistance unbalance between the channel pairs is a measure of the difference of resistance of the common mode pairs of conductors used for power delivery. Channel pair to pair resistance unbalance is defined by
- The **200milliohm** above should be **0.1Ω**. Why?. Connector max Rdiff= 0.05Ω. 4 connectors is 4*0.05Ω=0.2Ω on each Wire. As a result, a pair is two connectors in parallel → 0.1Ω
 - Connector maximum resistance is 0.2Ω and is not related to the discussion here which is pair to pair resistance difference.

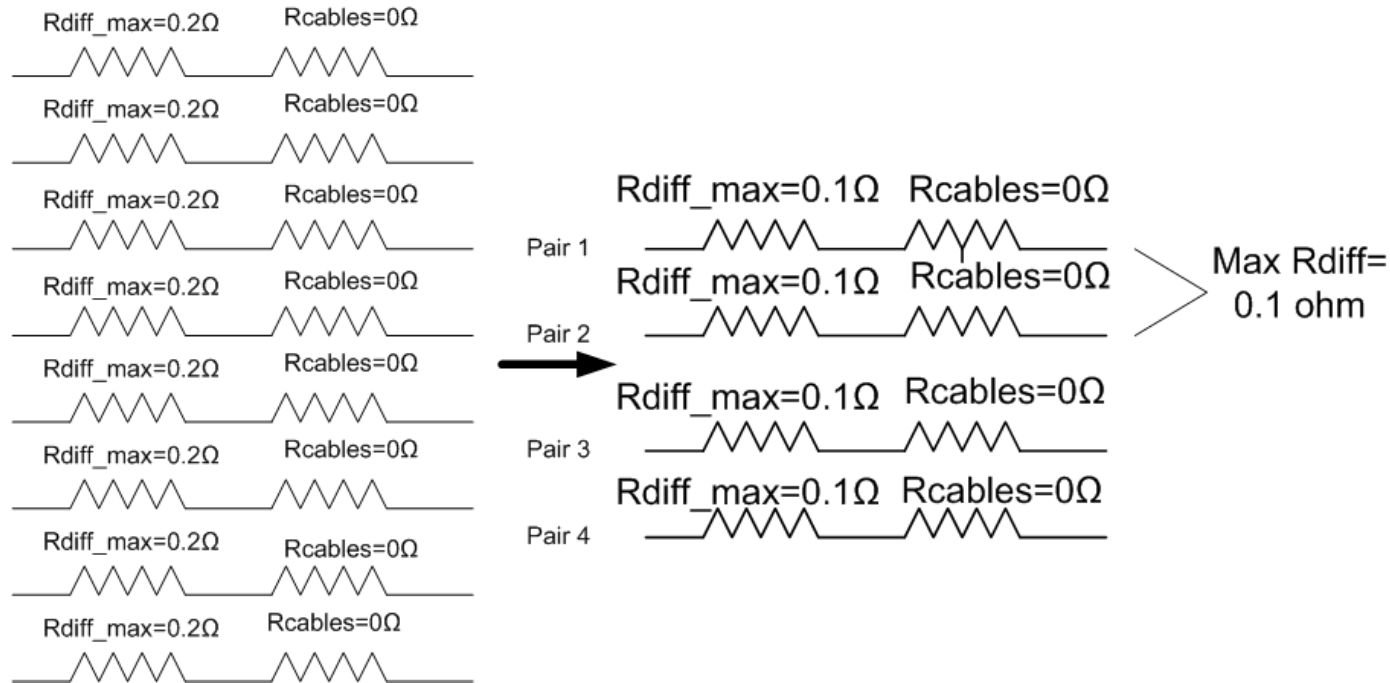

Source: Yair Darshan.
 Confirmed by Wayne Larsen

Annex P1: Channel P2PRUNB at Rdiff point

- Channel only Equation:

$$C_{_P2PRUNB} = \left(\frac{\sum R_{\max} - \sum R_{\min}}{\sum R_{\max} + \sum R_{\min}} \right) =$$

$$= \left(\frac{0.5 \cdot (L1 \cdot \rho_1 + L2 \cdot \rho_2 + N \cdot Rc)_{\max} - 0.5 \cdot (L1 \cdot \rho_1 + L2 \cdot \rho_2 + N \cdot Rc)_{\min}}{0.5 \cdot (L1 \cdot \rho_1 + L2 \cdot \rho_2 + N \cdot Rc)_{\max} + 0.5 \cdot (L1 \cdot \rho_1 + L2 \cdot \rho_2 + N \cdot Rc)_{\min}} \right)$$

- The factor 0.5 was left intentionally.
- When L1+L2 approaching to zero:

$$C_{_P2PRUNB} = \left(\frac{0.5 \cdot (N \cdot Rc_{\max} - N \cdot Rc_{\min})}{0.5 \cdot (N \cdot Rc_{\max} + N \cdot Rc_{\min})} \right) =$$

$$= \left(\frac{0.5 \cdot N \cdot Rdiff}{0.5 \cdot (N \cdot Rc_{\max} + N \cdot Rc_{\min})} \right) = 25\% \max \quad \text{For } Rc_{\min}=0.03\Omega \text{ and } Rc_{\text{diff}}=0.02 \Omega$$

Rdiff_max for channel: 0.1Ω

Source : Yair Darshan

Annex P2: Channel P2PRUNB at Rdiff point

$$C_P2PRUNB = \left(\frac{0.5 \cdot N \cdot Rc_{\max} - 0.5 \cdot N \cdot Rc_{\min}}{0.5 \cdot (N \cdot Rc_{\max} + N \cdot Rc_{\min})} \right) = \left(\frac{0.5 \cdot C_Rdiff_max}{0.5 \cdot (N \cdot Rc_{\max} + N \cdot Rc_{\min})} \right)$$

- Looking at the above equation:
- For C_P2PRUNB, as a parameter that specify the channel behavior, the number of connectors became irrelevant:

$$C_P2PRUNB = \frac{(Rc_{\max} - Rc_{\min})}{(Rc_{\max} + Rc_{\min})} \quad \text{Ratio} \rightarrow \text{Implementation independent}$$

- However for Rdiff it is relevant:

$$C_P2PRUNB = \left(\frac{0.5 \cdot C_Rdiff_max}{0.5 \cdot (N \cdot Rc_{\max} + N \cdot Rc_{\min})} \right)$$

$$C_Rdiff = 0.5 \cdot N \cdot (Rc_{\max} - Rc_{\min}) =$$

$$= 0.5 \cdot N \cdot Conn_Rdiff_max \quad \text{ABS number} \rightarrow \text{Implementation dependent}$$

Source : Yair Darshan

Annex P3: Channel P2PRUNB at Rdiff point

Complete Channel specification:

- (Complete specification is like defining the behavior of equation for its entire operating range and as close as possible to implementation independent)

- For $C_Rdiff > 0.5 \cdot N \cdot Conn_Rdiff_max = 0.1\Omega$

$$C_P2PRUNB = \left(\frac{(L1 \cdot \rho_1 + L2 \cdot \rho_2 + N \cdot Rc)_{max} - (L1 \cdot \rho_1 + L2 \cdot \rho_2 + N \cdot Rc)_{min}}{(L1 \cdot \rho_1 + L2 \cdot \rho_2 + N \cdot Rc)_{max} + (L1 \cdot \rho_1 + L2 \cdot \rho_2 + N \cdot Rc)_{min}} \right) = 7.5\% \text{ max}$$

- For $C_Rdiff \leq 0.5 \cdot N \cdot Conn_Rdiff_max = 0.1\Omega$

$$C_Rdiff_max = 0.5 \cdot N \cdot Conn_Rdiff_max = 0.1\Omega$$

$$C_P2PRUNB_max = \frac{(Rc_{max} - Rc_{min})}{(Rc_{max} + Rc_{min})} = 25\%$$

Which ever is greater

Numbers are based on worst case data base numbers

Source : Yair Darshan

Annex Q: Channel Rmin vs. Channel P2PRUNB and number of connectors

$$\text{Channel_P2PRUNB} = \alpha$$

$$\text{Cable_P2PRUNB} = \beta$$

$$R_{\text{cable_min}} = R_{\text{min}}$$

$$R_{\text{cable_max}} = R_{\text{max}} = R_{\text{min}} \cdot \frac{(1 + \beta)}{(1 - \beta)} = R_{\text{min}} \cdot \delta$$

$$\alpha = \frac{(R_{\text{max}} + N \cdot R_{\text{c_max}}) - (R_{\text{min}} + N \cdot R_{\text{c_min}})}{R_{\text{max}} + N \cdot R_{\text{c_max}} + R_{\text{min}} + N \cdot R_{\text{c_min}}} =$$

$$\alpha = \frac{N \cdot (R_{\text{c_max}} - R_{\text{c_min}}) + R_{\text{min}} \cdot (\delta - 1)}{N \cdot (R_{\text{c_max}} + R_{\text{c_min}}) + R_{\text{min}} \cdot (\delta + 1)} =$$

$$\alpha \cdot (N \cdot (R_{\text{c_max}} + R_{\text{c_min}}) + R_{\text{min}} \cdot (\delta + 1)) = N \cdot (R_{\text{c_max}} - R_{\text{c_min}}) + R_{\text{min}} \cdot (\delta - 1)$$

$$\alpha \cdot N \cdot (R_{\text{c_max}} + R_{\text{c_min}}) + \alpha \cdot R_{\text{min}} \cdot (\delta + 1) = N \cdot (R_{\text{c_max}} - R_{\text{c_min}}) + R_{\text{min}} \cdot (\delta - 1)$$

$$\alpha \cdot R_{\text{min}} \cdot (\delta + 1) - R_{\text{min}} \cdot (\delta - 1) = N \cdot (R_{\text{c_max}} - R_{\text{c_min}}) - \alpha \cdot N \cdot (R_{\text{c_max}} + R_{\text{c_min}})$$

$$R_{\text{min}} \cdot (\alpha \cdot (\delta + 1) - (\delta - 1)) = N \cdot (R_{\text{c_max}} - R_{\text{c_min}}) - \alpha \cdot N \cdot (R_{\text{c_max}} + R_{\text{c_min}})$$

$$R_{\text{min}} = \frac{N \cdot (R_{\text{c_max}} - R_{\text{c_min}}) - \alpha \cdot N \cdot (R_{\text{c_max}} + R_{\text{c_min}})}{\alpha \cdot (\delta + 1) - (\delta - 1)}$$

- Rmin is given as round loop value.
- Rc_max=0.05 ,Rc_min=0.03, β=Cable_P2PRUNB=5%
- Channel_P2PRUNB=α=7% as an example.

$$R_{\text{min}} = \frac{N \cdot (R_{\text{c_max}} - R_{\text{c_min}}) - \alpha \cdot N \cdot (R_{\text{c_max}} + R_{\text{c_min}})}{\alpha \cdot (\delta + 1) - (\delta - 1)}$$

Source : Yair Darshan.

Verified by analytical solution and simulations

n	Rcable min [ohm]	Channel Runb
0	Any	5.00%
1	0.342	7.00%
2	0.684	7.00%
3	1.026	7.00%
4	1.368	7.00%

Pair resistance is half the value