

IEEE802.3 4P Task Force
Channel Pair To Pair Resistance Imbalance
(End to End System Imbalance)
Ad Hoc

Meeting #1: Rev_001 Monday February 17, 2014

Meeting #2: Rev_001b Monday February 24, 2014

Meeting #3: Rev 004, Thursday April 24, 2014

Meeting #4: Rev 005, Thursday May 1, 2014

Norfolk VA

May 2014

Yair Darshan

Microsemi

ydarshan@microsemi.com

Meeting # 4 Attendees (Thursday May 1, 2014)

- Please email to me after the meeting to confirm your attendance

Meeting # 3 Attendees (Thursday April 24, 2014)

- Yan Zhuang / Huawei
- Ronald Tellas / Panduit
- Larsen, Wayne / Commscope
- Jeff Heath / LT
- Brian Buckmeier / BEL
- Rick Frosch / Phihong
- Christian BEIA / ST
- Leonard Stencil / Bourns
- Fred Schindler / Seen Simply
- Koussalya Balasubramanian / Cisco
- David Tremblay / HP
- David Abramson / TI
- Rimboim Pavlik / Microsemi
- Yair Darshan / Microsemi
- Ken Bennett / Sifos
- Victor Renteria / BEL
- George Zimmerman/ CME Consulting, Affiliations: Commscope & Aquantia

Next steps for 4th meeting May 1, 2014

- These are the items we agree last meeting to discuss at this meeting.
- See next slide for updated agenda and planes for last adhoc meeting on May 8, 2014 until our IEEE meeting at Norfolk VA.
- Generate proposal for Motion for cable P2PRUNB (5%)
- Generate proposal for Motion Motion for defining Channel P2PRUNB
- Generate proposal for Motion Motion for defining PSE PI P2PRUNB
- Generate proposal for Motion Motion for defining PD PI P2PRUNB
- Presenting proposals for baseline draft for Channel, PSE PI and PD PI P2PRUNB
- To present simulation results for the above parameters (may be ready for May 8, 2014)

Proposed Agenda, Meeting #4, May 1, 2014.

- Introduction
- Planes for this meeting May 1, 2014.
 - Discussing open items from last meeting and some proposed response to close some of it.
 - Discuss proposed baseline text and motions to define 4 new parameters as agreed on the 3rd meeting last week.
- Planes for next meeting on May 8, 2014
 - Discussing open items from last meeting and some proposed response to close some of it.
 - Discuss proposed baseline text
 - Proposing Motions drafts for closing items and moving forward.
- Adhoc response:

Introduction

- The purpose of this ad-hoc is to recommend the Task-Force for what is needed to specify the channel pair to pair resistance unbalance while considering not only the formal channel components (Cable and Connector) but also the Power Interface (PI) components at both ends of the 4P PoE system.
- Patent Policy
 - Please read the Patent Policy slides at <http://www.ieee802.org/3/patent.html> prior the meeting.
- All attendees please send mail approving your attendance at the add-hoc today

Acronyms used in the ad-hoc activity

- **(1) Pair resistance unbalance** : Is the resistance unbalance between two wires in the same pair as specified by IEEE802.3 and other standards. This is 2% for cable and 3% maximum for the channel. Channel is a 4 connector model (cables and connector only).
- **(2) Pair to Pair resistance unbalance**: is the resistance unbalance between two wires of the same pair connected in parallel to another two wires of other pair connected in parallel. It is 5% for a cable.
(The resistance of the two wires of the pair is know also as the common mode resistance of the pair)
- **(3) End to End channel pair to pair resistance unbalance"** it is the 26.2% worst case calculation on a worst case data base that we have generated. The 26.2% was calculated at 25degC. The channel is including components at PSE PI and PD PI that affects the whole end to end channel.
- **(4) PSE PI Pair to Pair resistance unbalance** is the P2P unbalance measured at the PSE PI and include PI interface circuitry such RDSON, Current sense resistor, equipment connector, magnetic winding resistance. This is included in the " end to end channel resistance unbalance" and need to be extracted from it to be separate definition for PSE PI P2PRUNB.
- **(5) PD PI Pair to Pair resistance unbalance** is the P2P unbalance measured at the PD PI and include PI interface circuitry such DIODE BRIDGE Voltage drop difference and dynamic resistance, equipment connector, magnetic winding resistance. This is included in the " end to end channel resistance unbalance" and need to be extracted from it to be separate definition for PD PI P2PRUNB.
- **(6) Channel Pair to Pair resistance unbalance** is the P2P resistance unbalance of the cables and 4 connector model. This need to be excreted from the " end to end channel resistance unbalance" and specified separately.
- So (PSE PI +Channel + PD PI)p2prunb all together is 26.2%.
- **Items 2, 4,5 and 6 will be specified in the standard.**
- **Adhoc response:**

Proposal text for Motion (1)

- Motion to require that the 802.3bt Task force will specify the requirements for the following parameters for operating 4P systems:
 - a) PSE PI Pair to Pair resistance unbalance
 - b) PD PI Pair to Pair resistance unbalance
 - c) Channel Pair to Pair resistance unbalance (formal 4 connector channel model)

The above parameters will be analyzed and specified based on the End to End Channel Pair to Pair Resistance Unbalance model as proposed by the ad-hoc. [See slide N, link..](#)

Proposal text for Motion (2)

Motion to add the following text to clause 33 after 33.1.4.2.

33.1.4.3 Type 3 and Type 4 Cable Requirement for Pair to Pair Resistance unbalance

4 pair operation, requires the additional specification of resistance unbalance between each two pairs of the cable. The cable pair to pair resistance unbalance shall be 5% (TBD) or less. Resistance unbalance between the pairs is a measure of the difference of resistance of the common mode pairs of conductors used for power delivery. Cable pair to pair resistance unbalance is defined by equation 33-1.1:

$$\left\{ \frac{\left(R_{cm_max} - R_{cm_min} \right)}{\left(R_{cm_max} + R_{cm_min} \right)} \times 100 \right\} \% \quad 33-1.1$$

where

R_{cm_max} is the pair with highest common mode resistance.

R_{cm_min} is the pair with lowest common mode resistance. Common mode resistance is the resistance of the two wires in a pair, connected in parallel.

Issues to be discussed in #3/4 meeting 24/April/ May 1, 2014 (1)

- How to address temperature effect on P2PCRUNB?
 - We agree that we don't care of high temperature since it works for us (high temperature higher resistance lower P2PCRUNB)
 - So the question is narrowed to below room temperature (20-24°C)?.

Yair response:

1. All parameters in the standard are tested for compliance at room temperature.

System and component vendors are responsible to design the parts/system to meet their spec over their spec of operating temperature range.

1. We can study and supply the guidelines/equations in informative annex to help decide what to do in temperatures below room temperature but it can't be part of the standard. (not high priority)

Please see what IEEE802.3-2012 says about this topic:

33.7.7 Temperature and humidity

The PD and PSE powered cabling link segment is expected to operate over a reasonable range of environmental conditions related to temperature, humidity, and physical handling. Specific requirements and values for these parameters are beyond the scope of this standard.

Recommendation: To focus on results at room temperature for the baseline.

Anything else could be:

- a) left for the informative section of the standard
- b) per 33.7.7

Please see what IEEE802.3-2012 says about this topic:

33.7.7 Temperature and humidity

The PD and PSE powered cabling link segment is expected to operate over a reasonable range of environmental conditions related to temperature, humidity, and physical handling. Specific requirements and values for these parameters are beyond the scope of this standard.

Yair's Recommendation: To focus on results at room temperature for the baseline.

Anything else could be:

- a) left for the informative section of the standard
- b) per 33.7.7

--- DISCUSSION -----

- (1) Yair: Define at 25degC and the rest put in the informative section
- (2) Jeff/Wayne: Mandatory section we need to define at 25degC and (-TBD)
- (3) Jeff: To define one number which is the worst case and will include low temperature (similar to a worst case of insertion loss at high temp.)

Yair: (May 1, 2014) During reflector discussion we saw that insertion loss is define at 20degC and at higher temperature derating is allowed by using shorter cable which means it is not specified for worst case operating temperature (ANSI/TIA 568-C.2 Annex G Clause 6.4.7.

-Christian: Testing cost issues in (2)

-Ad hoc agree to vote by mail and result will be our recommendation to task force to move forward.

Straw poll material was sent. See details next slides. Link to straw poll material.

Options for CP2PRUNB vs Operating temperature

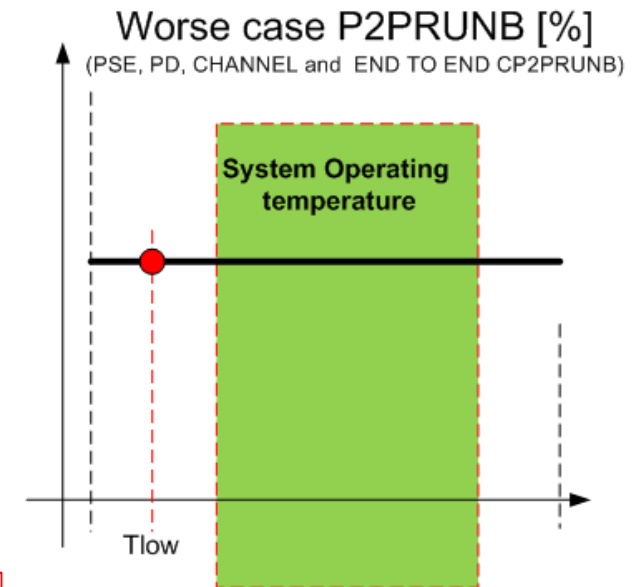
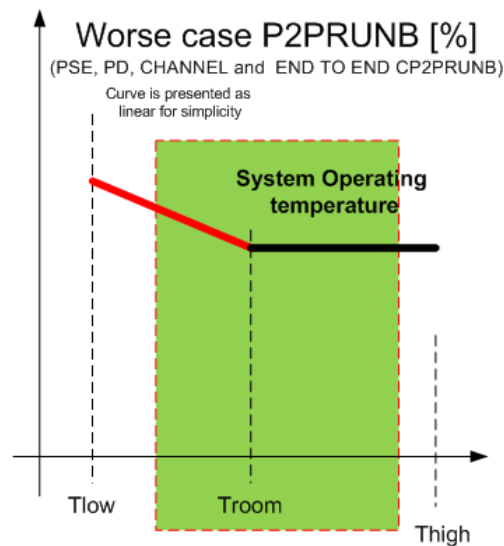
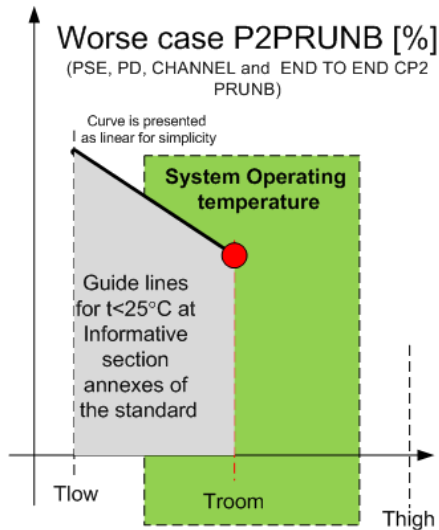

- Option 1
- Defining single point at e.g. Troom=20°C and:
- (a) add information for $T < T_{room}$ at the informative section **and/or**
- (b) follow Clause 33.7.7
- No Over Design since system vendor responsible to design their system to meet requirements.
- It may increase interoperability concerns???. This concern is valid in all options whenever there is no single worst case number that covers Tlow of 100% of use cases.
 - The remedy for it is specify the requirement and it is up to box designer to meet it over its operating temperature range.

- Option 2
- Defining curve from Tlow to Troom
- Tlow need to cover most of applications known to us.
- Prevents over design. (Allow system vendor to design for its operating temperature range)
- Tlow need to be investigated
- See interoperability concerns discussion in option 1

- Option 3
- Defining single point at Tlow which will be single worst case point.
- Tlow need to cover most of the applications min. temperature.
- This option may be overdesign for equipment with $T > T_{low}$. (To investigate)
- Equipment that need to work at $T < T_{low}$ shall follow Clause 33.7.7
- See interoperability concerns discussion in option 1

Straw Poll Results

- Select one option only.
- If possible, add rational for your selection, any concerns etc., new suggestions in the notes column.

Name	Options			Notes
	1	2	3	
Yair Darshan / Microsemi	x			Without having the informative part and using clause 33.7.7 instead (Option 1b or name it option 4)
Fred Schindler / Seen Simply			x	
Ken Bennett / Sifos	x			
Yseboodt, Lennart / Philips	x			
Jeff Heat / LT				Accept suggested proposal for option 4 (see mail) which is option 1b (to ask for email confirmation).
Wendt, Matthias / Philips	x			
Dave Dwelley / LT	x			
Rimboim Pavlik / MSCC	x			
Christian Beia / ST			x	
??				
??				

Note: **Option 4** language from reflector email exchange (short summary): "use the P2PRUNB for PSE, PD and Channel number that was calculating (total sum=26.2%) at room temperature (or pick number at other temperature), set it as THE number to meet without saying at what temperature it is, and vendors will have to assure that they meet it at their operating temperature range spec. How they will do it, we don't care." The rest is per 33.7.7. This option is covered by 1b.

- Results of the straw poll
- 6 for option 1 (5 for 1a or 1b, 1 for 1b)
- 2 for option 3
- 1 for 1b ?? (waiting for confirmation)

- Additional information:
- Base on reflector discussion it is summarized to:
- Use the P2PRUNB for PSE, PD and Channel number that was calculating (total sum=26.2%) at room temperature (or pick number at other temperature), set it as THE number to meet without saying at what temperature it is, and vendors will have to assure that they meet it at their operating temperature range spec. How they will do it, we don't care." The rest is per 33.7.7.

- This summary is covered by options 1b and 3.
(Option 1 says room temperature or other temperature
- Option 3 says lower temperature than room temperature)

Adhoc proposal for the Task force

- To follow the following proposed concept:
- Use the P2PRUNB for PSE PI, PD PD and Formal Channel numbers (e.g. that was calculating for a total sum of=26.2%) at 20degC (or pick a number at other temperature), set it as the number to meet without saying at what temperature it is, and vendors will have to assure that they meet it at their operating temperature range spec. How they will do it, we don't care. The rest is per 33.7.7.
- Adhoc response:
- Next question will be, OK, what is that temperature point?

Next question will be, OK, what is that temperature point?

■ Questions

- Is it correct to assume that for Environment A all system parts (Switch, PSE , PD cablings etc.) are at near room temperature?
- If bad ventilation it will be going up?
- Is there situations that for Environment A temperature will be near zero degC?

■ Proposals

- A) $T=20\text{degC}$
 - B) $T=0\text{degC}$
 - C) The Typical minimum temperature at enterprise environment, Environment A or equivalent
-
- Adhoc response:

Issues to be discussed in #3 meeting April 24, 2014

- We need to define the PD load current on Mode A and Mode B in which below that current, P2P requirements can be ignored.
 - Example: if Mode A requires 350mA and Mode B require 113mA than P2P discussion is not relevant to this case.
- We agree that we need to investigate it and address it.
 - Dave Dwelley made a comment about this issue which I didn't record.
 - Dave please send us your comment about this topic to be recorded and addressed.
 - **No response. Removing this item from the agenda.**
- **Proposals:**
 - (1) For PD total power below 25.5 Watts (that ensures pair current <600mA/pair), for any pair, meeting Channel Pair to Pair Resistance Unbalance is not required.

Yair: I agree with it. It helps for low cost PDs.

Adhoc response:
 - (2) For PD total power below TBD Watts that ensures pair current <600mA/pair, for any pair, meeting Channel Pair to Pair Resistance Unbalance is not required.
 - **(To discuss this face to face at May meeting.)**
 - **What is the TBD number ? Next question.**

What is the PD power/current where P2P requirements for a given P2P limit numbers are not changing system/components performance as it was not important for Type 2 systems?

- To be discuss during face to face meeting at Norfolk VA.
- Analytical results showing:
 - $I_{t_max} = 1.2A - P2PCRUNB * I_t$. (The decision break point of Type 3 systems)
 - If $I_t > I_{tmax}$, CP2PRUNB requirements shall be met for Type 3 and up systems.
 - If $I_t < I_{tmax}$ for Type 3 system, CP2PRUNB requirements are not required to be met.
- I_{t_max} s total PD current over all 4 pairs that is the P2PRUNB requirements are not affecting 4P operation similar to that it is not affecting 2P operation.
- Example: $I_{t_max} = 1.2A - 0.262 * 1.2A = 0.885A$.
- 4P PD with a power level that requires maximum 0.885A total on all 4 pairs, doesn't need to be concern by P2P requirements. **To work with adhoc if this is true statement.**

Issues to be discussed in #3 meeting April 24, 2014

- (1) What is the minimum resistance in the channel that above it, we don't care? In other words, what is the minimum resistance in the PD that makes the diodes, connectors, transformers less important in the total channel P2PRUNB?
- (2) Do we need to specify minimum length?.

Yair Response: we will know the answer based on (1) and running simulations/calculations per Wayne proposal for 4 channel length options.

- What will be minimum Ω/m for patch cords?
- Yair: I suggest to use the $9.38\Omega/100m$ ($93.8m\Omega/m$ as max value and 5% less as the minimum value since patch cords normally need to be flexible than the horizontal cable so their wire diameter is smaller than horizontal cables such as CAT6A.
- Yair: I remember that Wayne said that the 0.15m channel length option is with $14\Omega/100m$.
 - Wayne to confirm.
 - Wayne: What is your opinion to the above proposal?
- **Wayne response: See next slide.**

Issues to be discussed in #3 meeting April 24, 2014

- **Wayne response:** Thinking about possible use cases, it seems to me it is possible, someone may provide PSE equipment in a rack and PD equipment in the rack unit below it in the same rack. If we agree this is a possible use case, it could be connected by a patch cord 0.15 m long. Patch cords have a de-rated DC resistance requirement of $14\Omega/100\text{m}$, as Yair states. In finding the absolute minimum, someone could also use un-de-rated patch cord material.
- In any case, for this use case, I think the DC resistance, and the DC resistance unbalance, of the cabling system, is low enough that the equipment MDI, and other elements of the equipment circuit, will dominate.
- Yair response: Yes, in very short channel the equipment MDI, and other elements of the equipment circuit, will dominate i.e. it will be almost similar to the PSE PI and PD PI P2PRUNB that we agree that we need to define anyway. I will simulate results with 0.15m cable with $0.14\ \Omega/\text{m}$ when simulation only PSE and PD PIs.
- Group OK. 0.15m minimum. Follow Wayne proposal for 4 different channel length for calculation/analysis.

Issues to be discussed in #3 meeting April 24, 2014

- See inputs from Pete Johnson and Yair Darshan response regarding the method of calculating Runb at Annex A1. (If you disagree send email and we will discuss in next meeting. Other wise we agree to this response)
- **Adhoc agrees (no responses, removed from the agenda).**
- ----
- In IEEE802.3 March 2014 meeting , Jeff Heat had a comment for the PD model. Jeff to send the details of it to the ad-hoc if you want us to discuss it. (Jeff to send data and Dave response to next meeting).
- **No response. Removing this item from the agenda.**

-
- **See new data for P2PCRUN with out limiting the current to 600mA /pair with 6 connectors (On going).**
 - **See previous data presented again on slides 55 and 56 on issues reminding us why we are working on P2P issues and what was the concerns that we had to addressed. Do we have other concerns?**

Comparison between 4 connectors and 6 connectors Model. -6 Simulation Results

- Results for Table 1 right column data number set (minimum resistivity cable Type).
- Pairs were not limited to 0.6A
- Numbers were taken from the pairs with highest and lowest values.
- The model used is per Drawing #1

Simulation Results of worst-case analysis with 4 connectors				
Length[m]	Pair with minimum current [mA]	Pair with maximum current [mA]	Idiff=Max-Min [mA]	P2PCRunb [%]
0.15m				
1	385	659	275	26.30
10	415	636	221	21.04
100	500	626	126	11.19

Table 2

Simulation Results of worst-case analysis with 6 connectors TBD				
Length[m]	Pair with minimum current [mA]	Pair with maximum current [mA]	Idiff=Max-Min [mA]	P2PCRunb [%]
0.15m				
1				
10				
100				

Table 3

Quick Calculations of CP2PRUNB with constant power sink model

Equation	Channel Length	Units	1m	100m
	CP2PRU	-	0.26	0.112
	I	A	1.02	1.2
	I/2	A	0.51	0.6
$I \cdot \text{CP2PRUNB}$	DI	A	0.2652	0.1344
$I \cdot \text{CP2PRUNB} / 2$	DI/2	A	0.1326	0.0672
$I \cdot (1 + \text{CP2PRUNB}) / 2$	$I_{\max} = (I + d_i) / 2$	A	0.643	0.667
$I \cdot (1 - \text{CP2PRUNB}) / 2$	$I_{\min} = (I - d_i) / 2$	A	0.377	0.533
Sanity Check	I	A	1.02	1.2
Effect on I _{bias} of transformer: $3\% \cdot (I_{\max} - 0.6) / 2$	d(I _{bias})	mA	0.639	1.008

Recommendations

- To check also with 2 connectors as minimum. At 0.15m.
- To check 4c and 6C as planed.

Summary of open/closed issues -1

P=priority. P=1:Required for generating baseline draft numbers. P=2: May be part of informative section.
P=3: Nice to know.

#	Subject	Reference/Conclusions	Status	P
1	Model for simulations/calculations	Figure 1	Ad-hoc OK.	1
2	Worst case data base	Table 1	Ad-hoc OK.	1
3	Cable Channel P2PRUNB 5% max	Meeting #1	Ad-hoc OK.	1
4	Worst case End to End Channel P2P resistance/current unbalance results with 4 connectors	Table 2	Ad-hoc OK.	1
5	What is the equation to calculate Resistance unbalance and Current unbalance?	Physic's, Meeting #1 and 2. Annex a, A1 $I_{unb} = R_{unb} * \text{Total load current.}$	Ad-hoc OK	1
6	sensitivity Analysis to identify the main contributors of lesser power delivery.	Table 4 and 5	Ad-hoc OK	3
7	Do we need to specify minimum length?	Meeting #2. See Wayne proposal for 4 channel length options	Ad-hoc OK	1
8	To define PSE PI P2PRUNB	Meeting #1 and 2	Ad-hoc OK	1
9	To define PD PI P2PRUNB	Meeting #1 and 2	Ad-hoc OK	1
10	To set equation for evaluation maximum current unbalance through transformers	$I_{bias} = I_{unbalance} / 2 = C_{P2PRU} * I_{cable_max}$	Ad-hoc OK	2
11	To considering 100BaseT Ethernet devices or switches that do not implement transformers on the spare pairs so the range should be 0 Ohm to 130mOhm. •In the switch and PD, vendors will have to add equivalent resistor to compensate the PSE PI unbalance	Group response: This is implementation issue of PSE PD which needs to meet P2P channel resistance unbalance anyway.	Ad-hoc OK.	2

Summary of open/closed issues -2

P=priority. P=1:Required for generating baseline draft numbers. P=2: May be part of informative section.
P=3: Nice to know.

#	Subject	Reference/Conclusions	Status	P
12	How the constant power model at the PD helps us in regard to Channel P2PRUNB and specifically its effect on transformers?	Drawing 2. See the whole slide for details.	Ad-hoc OK.	1
13	sensitivity Analysis to identify the main contributors of resistance unbalance	Need to be done.	On going	1
14	Worst case End to End Channel P2P resistance/current unbalance results with 6 connectors	Table 3	On going	1
15	Statistical analysis results based on worst case data base in Table 1. Do we need to do it or we can live with worst case analysis?		On going	1
16	Channel P2PRUNB vs. operating temperature	Meeting #2 and #3. >room temperature: We don't care. Room temperature important for the standard. <Room temperature: Informative but not part of the standard	????	1
17	How connector contact aging will affect the results i.e. if min/max contact resistance difference will be increased	Meeting #1	???	1
18	Consider analyzing P2P current imbalance higher category cables than CAT6A.	Meeting #1 Response was: what will be the end of it? When to stop?	???	1

Summary of open/closed issues -3

P=priority. P=1:Required for generating baseline draft numbers. P=2: May be part of informative section. P=3: Nice to know.

#	Subject	Reference/Conclusions	Status	P
19	What is the load current that below it we don't care about Channel, PD PI and PSE PI P2PRUNB	Meeting #2 and 3	???	1
20	What is the minimum resistance in the channel that above it, we don't care about END TO END CHANNEL P2PRUNB?	Meeting #2		2
21	What is the wire resistance per meter for patch cords?	Meeting #2 and 3. Proposed 0.14Ω/m	????	1
22	To generate worst case analysis curve of maximum pair current vs cable length for Type 3 PD (51W max.)	Drawing 2. See the whole slide for details.	On going.	1
23	To investigate worst case results the 4 options proposed by Wayne	Summary of 2 nd meeting.	On going.	2



- Previous Meeting Material

Meeting # 1 Attendees (Monday Feb 17,2014)

- Yan Zhuang / Huawei
- Abramson David / TI
- Kousalya Balasubramanian/ Cisco
- Leonard Stencel / Bourns
- Larsen Wayne / Commscope
- Woudenberg Rob / Philips
- Picard Jean / TI
- Steinke Stephan / Molex
- George Zimmerman / CME Consulting / Commscope
- Sessa Panguluri/Broadcom
- Ken Bennett/ Sifos

- Gaoling Zou / Maxim
- Dave Dwelley / LT
- Lennart Yseboodt / Philips
- Wendt, Matthias / Philips
- Christian Beia / ST
- David Law / Hp

Meeting # 2 Attendees (Monday Feb 24,2014)

- Yan Zhuang / Huawei
- Kousalya Balasubramanian/ Cisco
- Leonard Stencel / Bourns
- Larsen Wayne / Commscope
- Ken Bennett/ Sifos
- Dave Dwelley / LT
- Jeff Heath / LT
- Christian Beia / ST
- Steinke Stephan / Molex
- George Zimmerman / CME
- Victor Renteria/BEL
- Abramson David / TI
- Gaoling Zou / Maxim
- Tremblay David/ HP
- Lennart Yseboodt / Philips
- Rob Woudenberg / Philips

Summary of previous work and conclusions -1

Cable pair to pair resistance unbalance (P2PRU)



- In order to specify the ***pair to pair channel resistance imbalance*** we had to know the channel ***components pair to pair*** resistance unbalance such as:
 - Cable (not defined by cabling vendors),
 - Connectors, (Specified but not represents worst case numbers)
 - Transformers, (Vendors data is available. Not part of the formal channel)
 - PSE output resistance (Vendors data is available. Not part of the formal channel)
 - PD input resistance (Vendor data is available, Not part of the formal channel)
- We have good and sufficient data for all the components **except the cable**.
- We developed a method that predicted the cable Pair to Pair resistance imbalance from the other cable parameters such Propagation delay, Skew, wire diameter, wire insulation material and other.
- The predictions showed that P2P Cable Resistance Unbalance <5%
- Lab Tests confirmed that it was <5%
- Long list of experts (including cable experts) agree with the conclusions.
- All details can be found in:
http://www.ieee802.org/3/4PPOE/public/nov13/darshan_01_1113.pdf

Summary of previous work and conclusions -2

Channel pair to pair resistance unbalance (C_P2PRU)

- Initial Work to determine channel pair to pair resistance unbalance:
 - http://grouper.ieee.org/groups/802/3/4PPOE/public/jul13/beia_1_0713.pdf
 - http://grouper.ieee.org/groups/802/3/4PPOE/public/jul13/darshan_2_0713.pdf
- After getting comments from the group and using same worst-case data base and model:
 - http://www.ieee802.org/3/4PPOE/public/nov13/darshan_03_1113.pdf
 - http://www.ieee802.org/3/4PPOE/public/nov13/beia_01_1113.pdf
- General Channel Model and its components that we have used: See next slide.

Summary of previous work and conclusions

-3

General Channel Model and its components that we have used.

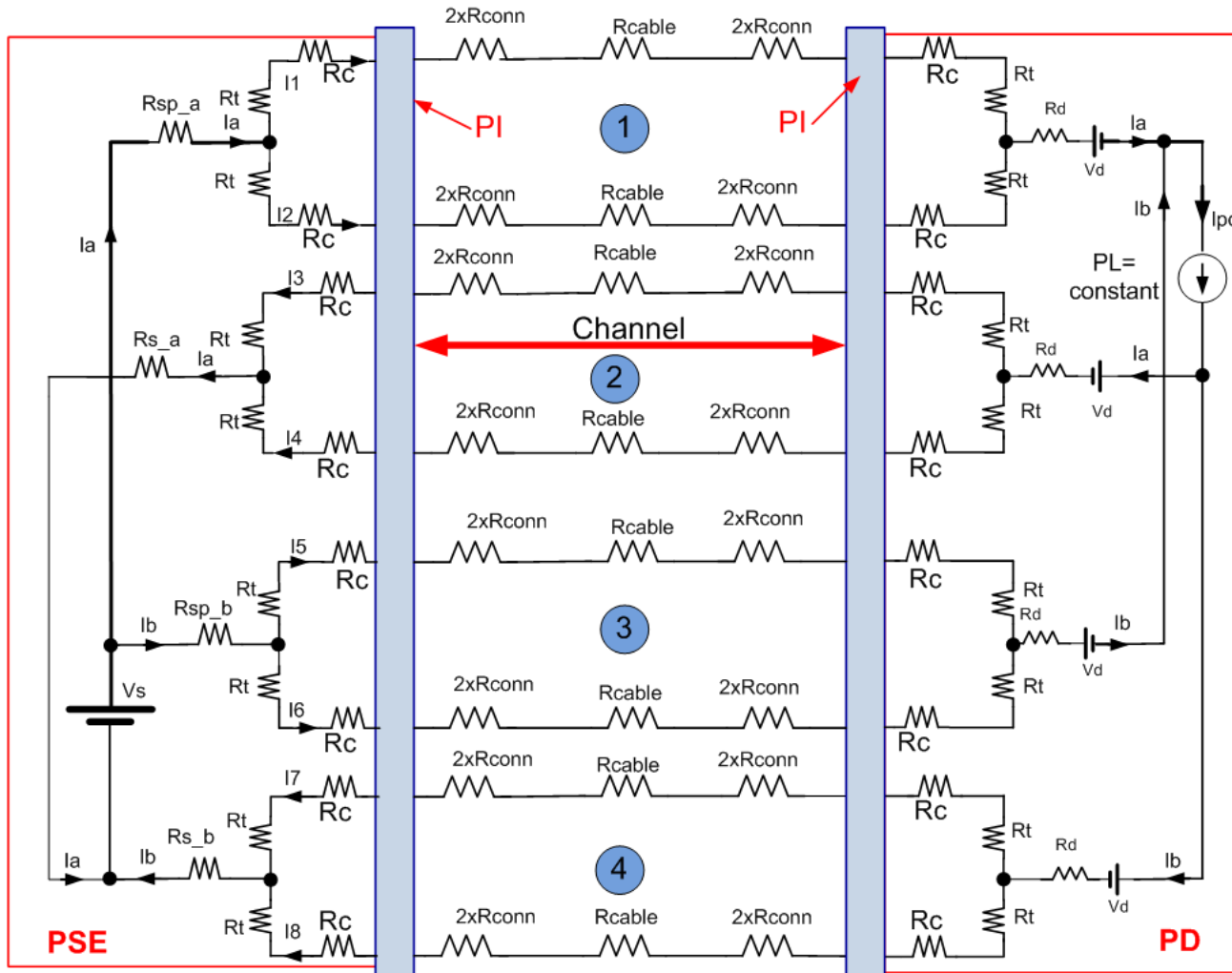

Notes for the general Model:

1. Adding resistors on positive path for general model (R_{sp_a} and R_{sp_b}). It can be set to zero or $>zero$ pending the case being investigated.
2. Adding equipment connectors per Wayne's comment. So total end to end channel connectors is 6 max.
3. The formal channel definition is marked in red arrow.
4. Our work addresses also the internal application resistance of known components that are used

Drawing 1

Summary of previous work and conclusions

-4

Data set that we use as worst case numbers

From: http://www.ieee802.org/3/4PPOE/public/nov13/beia_01_1113.pdf

Table 1	Data set 1 (Max Cable resistivity)	Data set 2 (Min Cable resistivity)
Cable resistivity	117mOhm/m* (maximum value) (CAT5e) Pair resistance unbalance: 2% → Minimum wire resistance=0.98*117mΩ/m Pair to pair resistance unbalance: 5% → Pair resistance max=~(117mΩ/m)/2 → Pair resistance min=~(0.95*117mΩ/m)2	66mOhm/m* (CAT6A) Pair resistance unbalance: 2% → Minimum wire resistance=0.98*66mΩ/m Pair to pair resistance unbalance: 5% → Pair resistance max=~(66mΩ/m)/2 → Pair resistance min=~(0.95*66mΩ/m)2
Transformer winding resistance	120mOhm min, 130mOhm max	120mOhm min, 130mOhm max
Contact resistance	30mOhm min, ** 60mOhm max	30mOhm min, ** 60mOhm max
Diode bridge	0.3V+0.4Ohm*Id min; 0.4V+0.5Ohm*id max	0.3V+0.4Ohm*Id min; 0.4V+0.5Ohm*id max
PSE output resistance (e.g. $R_{s_a/b} = R_{sense} + R_{dson}$)	0.25+0.1 Ohm min 0.25+0.2 Ohm max	0.1+0.05 Ohm min 0.1+0.1 Ohm max

- Two scenarios have been identified: max wire resistivity Data set 1 (CAT5E cables) and min wire resistivity Data set 2 (CAT6/A cables)
- *Cable pair to pair resistance max unbalance is set to 5%. See darshan_1_1113.pdf. Cable resistance within pair unbalance is max 2%.
- **Connector contact aging will be addressed in other work.
- All parameters are at room temperature and further study is required to address temperature variations

Summary of previous work and conclusions

-5

Simulation Results

- Results for Table 1 right column data number set (minimum resistivity cable Type).
- Pairs were not limited to 0.6A
- Numbers were taken from the pairs with highest and lowest values.
- The model that was simulated is with 4 connectors only as in the link below.
 - http://www.ieee802.org/3/4PPOE/public/nov13/darshan_03_1113.pdf

Simulation Results of worst-case analysis				
Length[m]	Pair with minimum current [mA]	Pair with maximum current [mA]	Idiff=Max-Min [mA]	P2PCRUnb [%]
1	385	659	275	26.30
10	415	636	221	21.04
100	500	626	126	11.19

Table 2

$$P2PCRUNB = \frac{I_{max} - I_{min}}{I_{max} + I_{min}}$$

Summary of previous work and conclusions -6

- See details:
http://www.ieee802.org/3/4PPOE/public/nov13/beia_01_1113.pdf
- What we did was a We need to do the work for sensitivity analysis for channel pair to pair resistance unbalance regardless of power delivery constrains.

Max res scenario	Component UNB[±]	Effect on power delivery [-]		
		1m	10m	100m
Cable lenght				
Rt	4%	0.17%	0.10%	0.01%
Rconn	33.30%	1.02%	0.58%	0.08%
r_cable	5%	0.20%	1.13%	1.68%
Rdiode	11.10%	3.43%	1.96%	0.32%
Vdiode	14.30%	5.72%	3.27%	0.53%

Table 4

Min res scenario	Component UNB[±]	Effect on power delivery [-]		
		1m	10m	100m
Cable lenght				
Rt	4%	0.18%	0.12%	0.03%
Rconn	33.30%	1.06%	0.73%	0.16%
r_cable	5%	0.12%	0.81%	1.79%
Rdiode	11.10%	3.56%	2.48%	0.57%
Vdiode	14.30%	5.94%	4.14%	0.96%

Table 5

Summary of previous work and conclusions

-7

Conclusions

- See details:
http://www.ieee802.org/3/4PPOE/public/nov13/beia_01_1113.pdf
- Main conclusions relevant for channel pair to pair resistance unbalance (short summary)
- P2P current imbalance increases when cable length decreases.
- P2P current imbalance increases when cable resistivity decreases i.e. CAT6A will have higher current imbalance compared to CAT5e.
- Unbalance within a pair (the famous 2% pair and 3% channel) has negligible effect on P2P unbalance.
- We need to define the requirements for P2P Runb for the PD, Channel and PSE in order to meet our objectives.

Summary of previous work and conclusions

-8

Conclusions

- To analyzed the following scenarios:
 - How connector contact aging will affect the results i.e. if min/max contact resistance difference will be increased.
 - The current unbalance results as function of operating temperature range
 - To analyze the results when there is no hard limit of 600mA on the negative pair. **Done:**
See Table 2 and see:
http://www.ieee802.org/3/4PPOE/public/nov13/darshan_03_1113.pdf
 - Consider analyzing P2P current imbalance higher category cables than CAT6A
 - **Response at the meeting was: what will be the end of it? When to stop?**
 - To perform sensitivity analysis for P2P resistance (current) imbalance.
 - To set a worst case conditions for evaluating maximum current imbalance through transformers.

Done: $I_{bias} = I_{unbalance} / 2 = CP2PRU * I_{cable_max}$.

What are the parameters that must be define?

- As done in IEEE802.3-2012 (*See Annex A*) when we define the pair (wire to wire in the same pair) in the cable pair(s) and in the channel, we need to do it for the Pair to Pair Resistance Unbalance in the cable and in the channel.
- Cable Pair to Pair Resistance Unbalance (P2PRU)
 - Based on the work done at http://www.ieee802.org/3/4PPOE/public/nov13/darshan_01_1113.pdf , it is proposed to specify it to 5% until formal number will be received from TIA/EIA. (group OK with recommendation)
- Channel Pair to Pair Resistance Unbalance (C_P2PRU)
 - We need to decide if we can work with the worst case numbers?
Or we need to add the probability factors to lower them.
 - To add probability factors and move on (request from magnetic vendors for lowest number).

Analysis Methods and Data-Base

- Analysis Method
 - Worst-Case Analysis
 - We did a worst-case analysis for the channel pair to pair resistance unbalance on a proposed worst-case data
 - Any comments on the worst-case data base?
 - To considering 100BaseT Ethernet devices or switches that do not implement transformers on the spare pairs so the range should be 0 Ohm to 130mOhm.
 - In the switch and PD vendor will have to add equivalent resistor to compensate the PSE PI unbalance. To discuss this approach.
 - Group response: This is implementation issue of PSE PD which needs to meet P2P channel resistance unbalance anyway.
 - Any comments on the model used (Group response: No.)
- Next Steps

Do we need to specify PSE and PD PI P2P Resistance Unbalance or leave it to be implementation specific as long as C_P2PRU is met?

- Do we need to specify the following additional parameters or leave it to be implementation specific as long as C_P2PRU is met?
 - PSE PI Pair to Pair Resistance Unbalance (PSE_P2PRU)
 - PD PI Pair to Pair Resistance Unbalance (PSE_P2PRU)
 - In the current standard the pair resistance unbalance was defined to 2% and the channel (cable and connector only) to 3% (See Annex A).
 - It was the responsibility of the equipment vendor to make sure that his design will meet all system requirement based on the above specification.
 - In 802.3at extensive work was done and shows that the actual pair channel resistance unbalance is higher than 3% (due to other components in the system) and yet system vendors and components ensure operation under this conditions.
 - Now we are addressing the P2P channel Resistance Unbalance and we have the same question: Do we need to specify the following additional parameters or leave it to be implementation specific as long as C_P2PRU is met?
 - If we do want to define PSE_P2PRU and PD_P2PRU.
 - Should we define only PD_P2PRU since it is not always required for the PD (it is PD power dependent and if defined at PSE it will be required for every port

Discussions and conclusions

- To ask magnetic component vendors if they can handle the worst-case analysis numbers or we should do statistical analysis as well.
 - If they can, we use the results to define the end to end channel P2P resistance unbalance.
- To define 3 new parameters
 - (1) To define the channel (PI to PI) Resistance unbalance (cables and connectors) with the contributions of PSE and PD PI P2P Resistance Unbalance.
- From (1) to separately define
 - PSE PI P2PRUNB and PD P2PRUNB
 - To define the channel (PI to PI) Resistance unbalance (cables and connectors).
 - As a result component and system vendors could use it for designing their components.
- We accept that P2P Cable Resistance Unbalance is 5% until formal number will be received by TIA/EIA etc.
- Yair to work with transformer vendors to get the data we need.
- To look for the best cable (lower resistance per meter) expected in the next 10+years and use it in our worst case data base numbers.
- To verify that LDO is covered by PD constant power sink. Done. It is covered.
- To consider 100BaseT Ethernet devices or switches that do not implement transformers on the spare pairs so the range should be 0 Ohm to 130mOhm.
 - In the switch and PD vendor will have to add equivalent resistor to compensate the PSE PI unbalance. To discuss this approach.
- No other comments on previous work done nor on model or database used.
- Group to send comments on model and data base and we will update it if found.

For next meeting

-1

- To discuss the advantages that PD constant Power Sink allows us.
- Background material for considering:
 - Worst case Channel Pair to Pair Channel Resistance Unbalance is at short cable (<100m).
 - At short cables PD voltage is higher than at 100m channel length and pair/port current is lower
 - Not only that the port current is lower, it is <600mA for Type 3 systems below TBD channel length.
 - As a result, P2PCRUNB is not an issue.
 - At 100m the P2PCRUNB is much smaller than at short channel
 - Resulting with less significant contribution to I_{bias} due to P2PCRUNB and as a result to OCL. This approach was validated in:
http://grouper.ieee.org/groups/802/3/4PPOE/public/jul13/darshan_2_0713.pdf and requires further investigation for completing this work.

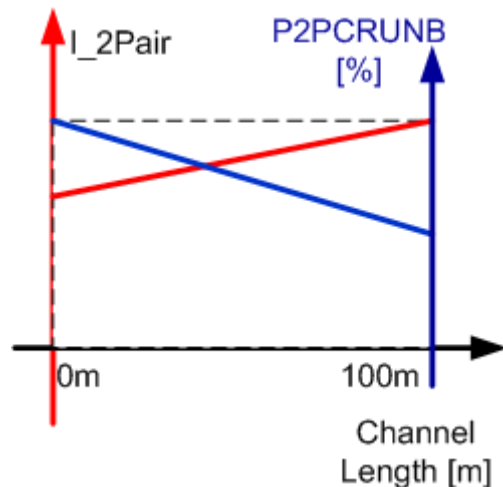

Illustration of the behavior.
(The curve is not linear. It is just describing the trend.)

Drawing 2

For next meeting

-2

- We need to define the PD load current on Mode A and Mode B in which below that current, P2P requirements can be ignored.
 - Example: if Mode A requires 350mA and Mode B require 113mA than P2P discussion is not relevant to this case.

PSE_PI Pair to Pair Resistance Unbalance

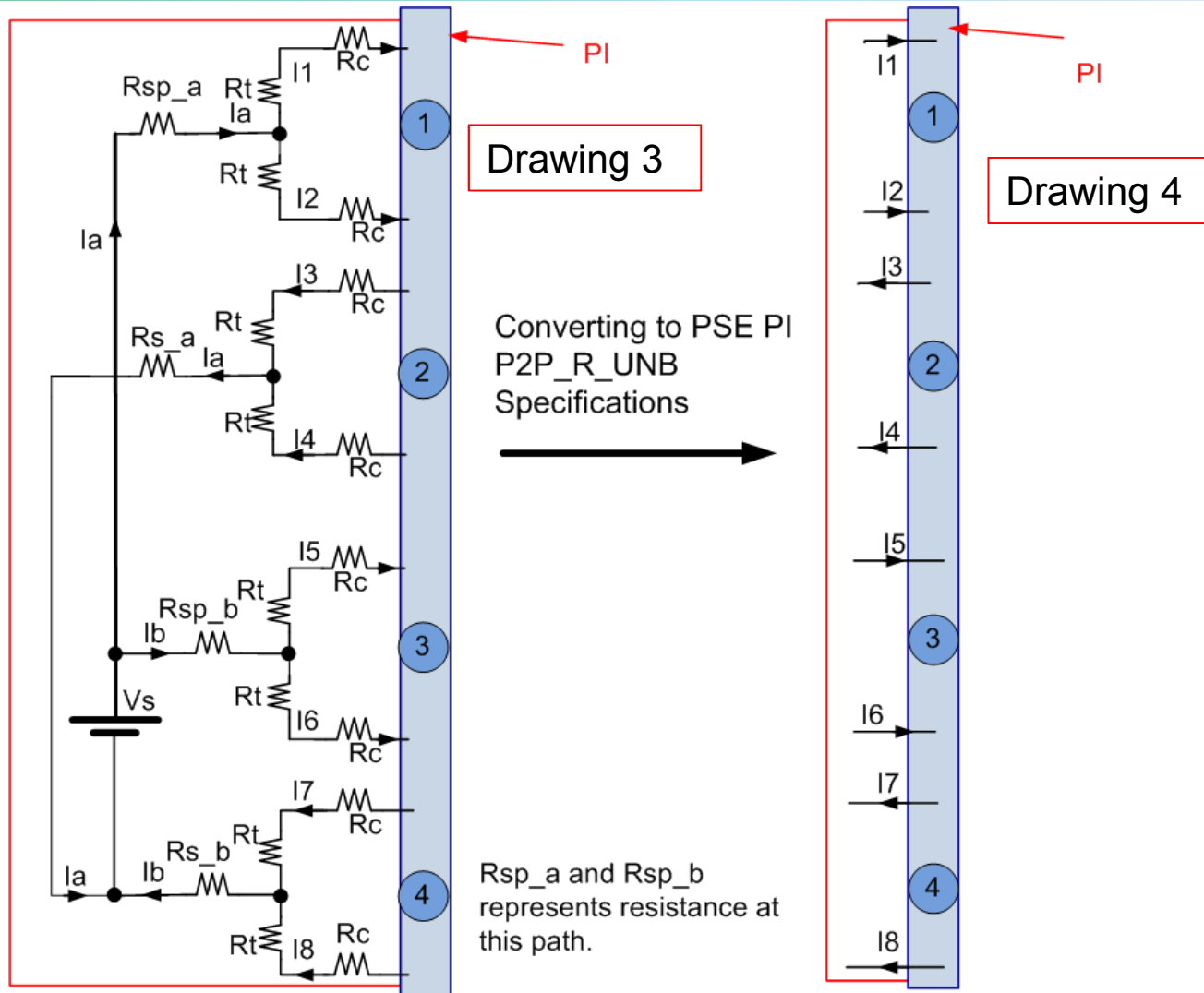

- To specify test setup as well

PD_P1 Pair to Pair Resistance Unbalance

- Same concept for PD P1 P2P_R_UNB definitions
- To specify test setup
- We may need to define P2P voltage offset difference in addition to P2P resistance unbalance

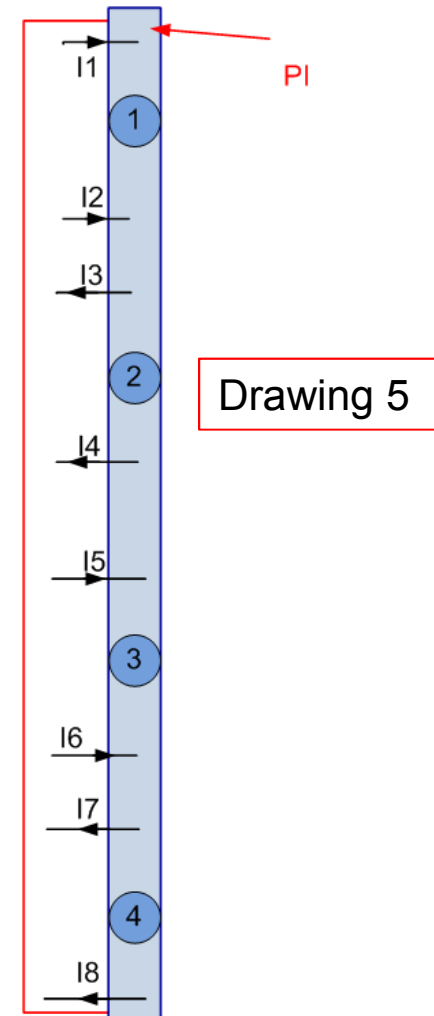

Summary of 2nd meeting

- 1

- (Text marked blue was added after the meeting and is not part of the meeting summary. It will be discussed on our 3rd meeting to be approved.)
- Wayne Larsen present data regarding:
 - Summary of resistivity and resistance unbalance specifications in TIA cabling standards
 - **Suggested topologies to study**
 - A. 6 inch (0.15 m) of cordage, no connectors.
 - B. 4 m channel with 1 m of cordage, 3 m of cable, 2 connectors
 - C. 23 m channel with 8 m of cordage, 15 m cable, 4 connectors
 - D. 100 m channel with 10 m of cordage, 90 m of cable, 4 connectors
 - Calculated channel resistance and unbalance (not including PSE and PD components) for the above topologies and the calculation details in separate Excel file done for maximum TIA numbers.
- Yair notes for the calculation results
 - The results reflects maximum cable (9.38Ω/100m) and connectors (300mΩ) resistance specified by TIA. *We are looking for lower cable resistance and connectors to reflect real life and also worst case in terms of P2PCRUB.*
 - *Christian and Yair proposed to use cable with 66mOhm/m and connectors with 30mOhm min, 60mOhm max per the data in slide 9.*
 - Proposed channel length options to investigate looks reasonable.

Summary of 2nd meeting

- 2

- We review the updated model and we agree to use it as our base line for simulating different operation scenarios.
- Until other worst case numbers regarding cables and other components in the channel from end to end, we will use the numbers in the table slide 9, minimum resistivity cable model column.
- We adopt the 5% cable P2PRUNB until formal number will be received from TIA/EIA etc.
- We add two additional connectors to the model to investigate the effect of it on the end to end P2PCRUNB.

(formal channel is 4 connectors maximum)

- To consider 100BaseT Ethernet devices or switches that do not implement transformers on the spare pairs so the range should be 0 Ohm to 130mOhm.
 - Yair note: In the Switch/Midspan and PD vendors will have to add equivalent resistor to compensate the PSE PI unbalance.
 - Group: This is implementation issue of PSE PD which needs to meet P2P channel resistance unbalance anyway. We will craft the optimum wording when the time comes.

- The following questions and issues were raised
- (1) What is the minimum resistance in the channel that above it, we don't care? In other words, what is the minimum resistance in the PD that makes the diodes, connectors, transformers less important in the total channel P2PRUNB?
- (2) Do we need to specify minimum length?
 - Yair: we will know the answer based on (1) and running simulations/calculations per Wayne proposal for 4 channel length options.
- What will be minimum Ω/m for patch cords?
- Yair: I suggest to use the $9.38\Omega/100m$ ($93.8m\Omega/m$ as max value and 5% less as the minimum value since patch cords normally need to be flexible than the horizontal cable so their wire diameter is smaller than horizontal cables such as CAT6A).
- Yair: I remember that Wayne said that the 0.15m channel length option is with $14 \Omega/100m$.
 - Wayne to confirm.
 - Wayne: What is your opinion to the above proposal?

Summary of 2nd meeting

- 4

- We need to define the PD load current on Mode A and Mode B in which below that current, P2P requirements can be ignored.
 - Example: if Mode A requires 350mA and Mode B require 113mA than P2P discussion is not relevant to this case.
- We agree that we need to investigate it and address it.
- **Dave Dwelley made a comment about this issue which I didn't record.**
- **Dave please send us your comment about this topic to be recorded and addressed.**

- We need to conduct sensitivity analysis for P2PCRUNB with constant power sink and without limitations on current per pair. What we had is for determining the PD minimum available power.

- How to address temperature effect on P2PCRUNB?
 - We agree that we don't care of high temperature since it works for us (high temperature higher resistance lower P2PCRUNB)
 - So the question is narrowed to below room temperature (20-24°C)?.

Yair:

1. All parameters in the standard are tested for compliance at room temperature. (to confirm)
2. System and component vendors are responsible to design the parts/system to meet their spec over their spec operating temperature range.
3. We can study and supply the guidelines/equations in informative annex to help decide what to do in temperatures below room temperature but it can't be part of the standard.
4. Please see what IEEE802.3-2012 says about this topic:

33.7.7 Temperature and humidity

The PD and PSE powered cabling link segment is expected to operate over a reasonable range of environmental conditions related to temperature, humidity, and physical handling. Specific requirements and values for these parameters are beyond the scope of this standard.

Annex A

33.1.4.2 Type 1 and Type 2 channel requirement

Type 1 and Type 2 operation requires that the resistance unbalance shall be 3 % or less. Resistance unbalance is a measure of the difference between the two conductors of a twisted pair in the 100 Ω balanced cabling system. Resistance unbalance is defined as in Equation (33–1):

$$\left\{ \frac{(R_{\max} - R_{\min})}{(R_{\max} + R_{\min})} \times 100 \right\} \% \quad (33-1)$$

where

R_{\max} is the resistance of the channel conductor with the highest resistance
 R_{\min} is the resistance of the channel conductor with the lowest resistance

- The way channel pair (the differences between two wires in a pair) resistance unbalance was defined.

Annex A1

- Inputs from Pete Johnson:
- 3% DC Unbalance comes from ISO / IEC.
- **TIA 568** has DC Unbalance specified as 5% using **ASTM D 4566** definition of DC Unbalance that is different from that used by ISO.
- The ASTM method is $\% \text{ Runbal} = 100 * (\text{Max R} - \text{Min R}) / \text{Min R}$
-
- Yair Response (to be discussed by the group) next (3rd meeting):
 - Since cables vendor wants to meet "all standards" they meets the 2% cable. System and component vendors count on the 3% channel.
 - Our IEEE POE standard is counting on the 3% max.
 - The ASTM method that calculates $\% \text{ Runbal} = 100 * (\text{Max R} - \text{Min R}) / \text{Min R}$ is familiar but has no practical physical meaning related to current unbalance that we can use e.g. for transformers. The equation that we are using is a derivation of the current unbalance definition and rationale.
 - As a result, I believe we should stay with current 3% pair resistance unbalance and our IEEE equation for Unbalance.
- Pete agrees to this response.

Annex B – Connectors terms.

- **Source Yakov Belopolsky / Stwconn.**
- The term used in the connector industry is LLCR (Low Level Contact Resistance)- Bulk R_{LLCR-B}
- Low Level Contact Resistance (LLCR-Bulk) consists of four components
 - Plug Conductor Resistance R_{CR}
 - Plug Blade/Conductor Contact Resistance R_{PBCR}
 - Plug Blade/Jack Wire Contact Resistance or TRUE LLCR R_{CRTRUE}
 - Jack Wire Resistance R_{JWR}
- $R_{LLCR-B} = R_{CR} + R_{PBCR} + R_{CRTRUE} + R_{JWR}$
- However, it is easy to measure and subtract $(R_{CR} + R_{PBCR})$ from the Bulk so many connector vendors use the Contact resistance $(R_{CRTRUE} + R_{JWR})$
- A typical differential between two types measurements is less than 20 milliohm
- The reason is that the $(R_{CRTRUE} + R_{JWR})$ is affected by environmental exposure and defines the quality of the connector design separately from the plug blade termination quality

Why we care for P2P resistance unbalance parameters (1)

- In 4P system:
- If $P2PRUNB > 0$ the PD total current over each 2P will not be the same.
 - 51W PD with maximum total current of 1.2A, the current will split to $0.6A + 0.18A = 0.78A$ over the 2pairs with minimum resistance and 0.42A with the pair with maximum resistance.
- In general: The pair with the highest current will be:
 $I_t \cdot (1 + P2PRUNB) / 2$
 - This will require to overdesign the magnetics for high P2PRUNB values.
 - Watching limits of connector pins, PCB traces and power components on the DC current path at PSE and PD and overdesign accordingly.
 - So there is interest to have components with lower P2PRUNB along the channel as possible by cost and manufacturability limitations to result with lower End to End Pair to Pair RUNB.

Why we care for P2P resistance unbalance parameters (2)

- Other concerns were how it will affect on PD minimum available power for a 60W system (two times the 802.3at power). The decision was that for our current data base we can supply 49W for the PD (instead of 51W). See 802.3bt objective.
 - This was done by calculating what will be the power at the PD if we keep maximum 600mA at the pair in order not to cause issues to Type 2 component/ devices that can work with 4P
- Other concern was if P2PRUNB will increase power loss on the cable. We show that now it will not. Moreover we show that if P2PRUNB increased, the power loss is decreased.

$$Trise = 0.5 \cdot N \cdot It^2 \cdot R_{loop_max} \theta_N \cdot [1 - P2PCRUNB]$$

- See: http://www.ieee802.org/3/4PPOE/public/nov13/darshan_02_1113.pdf for more details.