

---

# Performance Data For Serial I/O

IEEE 802.3 Albuquerque meeting  
March 6-10, 2000

Joel Goergen, Kamran Azadet,  
Tom Truman, Leilei Song,  
Giorgio Giaretta

Bell Laboratories  
Lucent Technologies

# OUTLINE

---

- Current Trends in Design Driving I/O Performance
- Performance Measurement Setup - Differential
- Differential Data Eye Patterns
- Differential Data Summary
- Performance Measurement Setup - Optical
- Optical Data Eye Patterns
- Optical Data Summary
- IDLE Pattern Spectral Measurements
- Wrap-up

# Current Trends in Design Driving I/O Performance

---

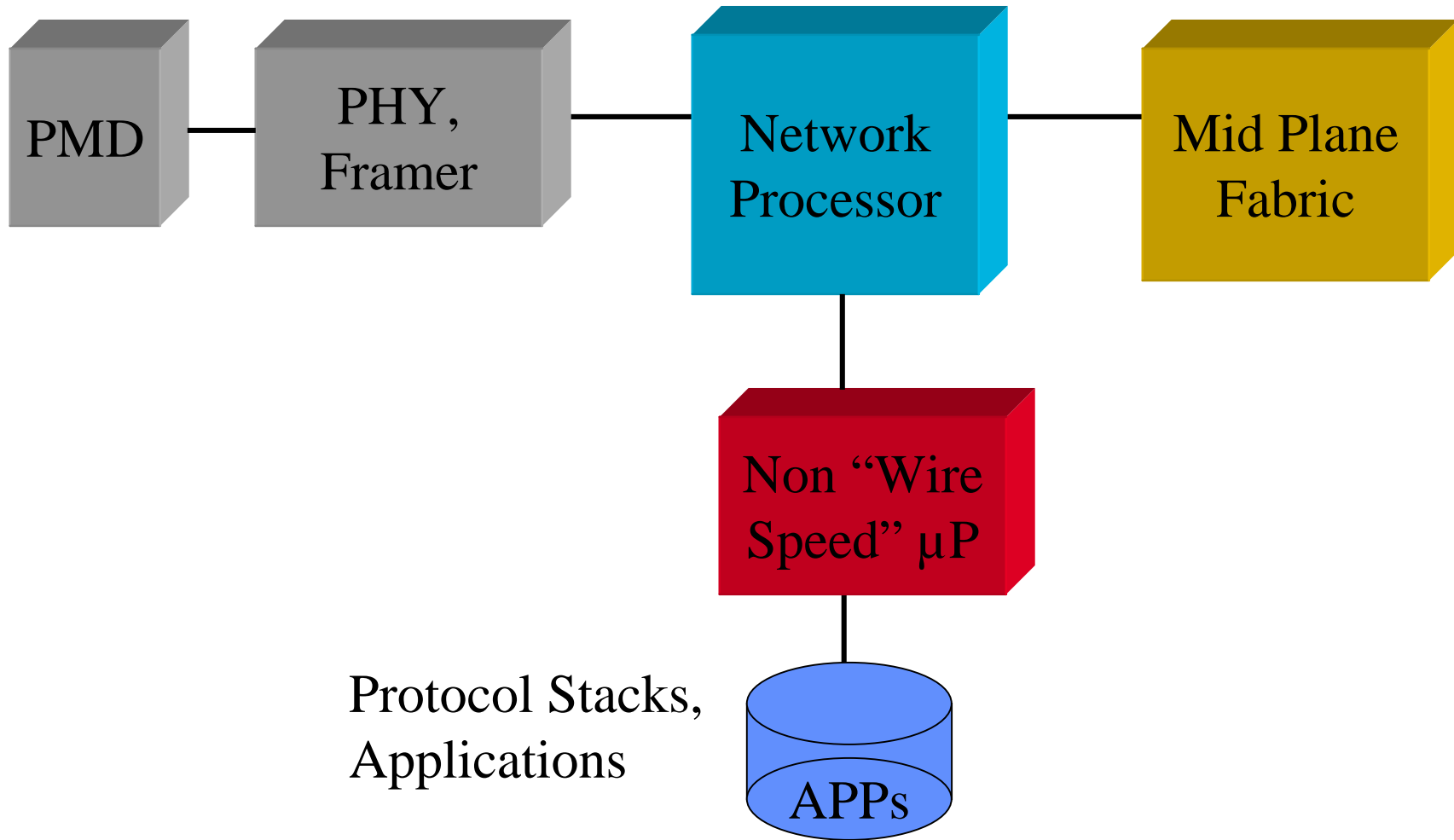

# Current Trends in Design Driving I/O Performance

## Mid Plane Application

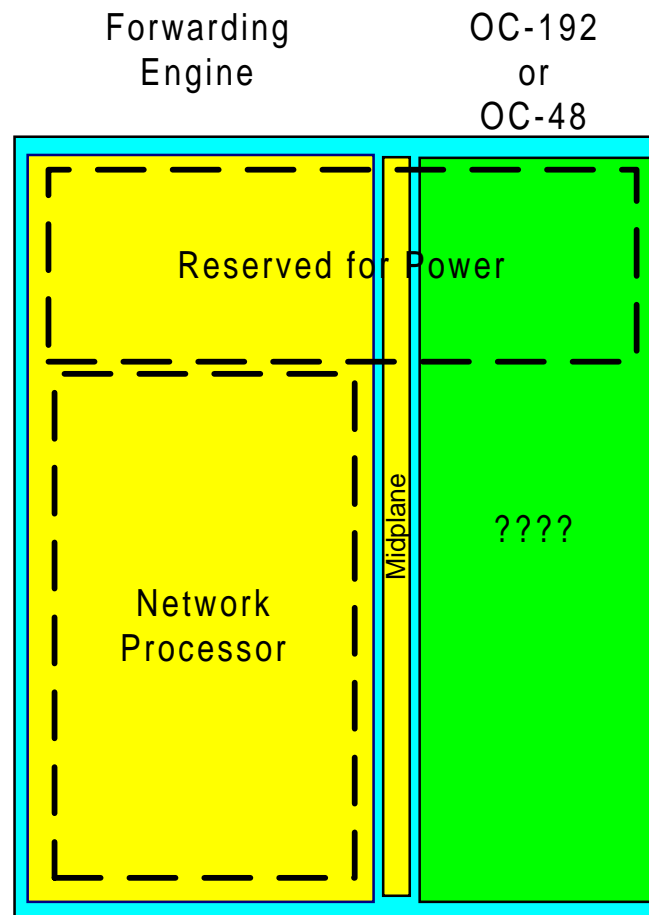

# Current Trends in Design Driving I/O Performance

## Back Plane Application

OC-192  
or  
OC-48

Forwarding  
Engine

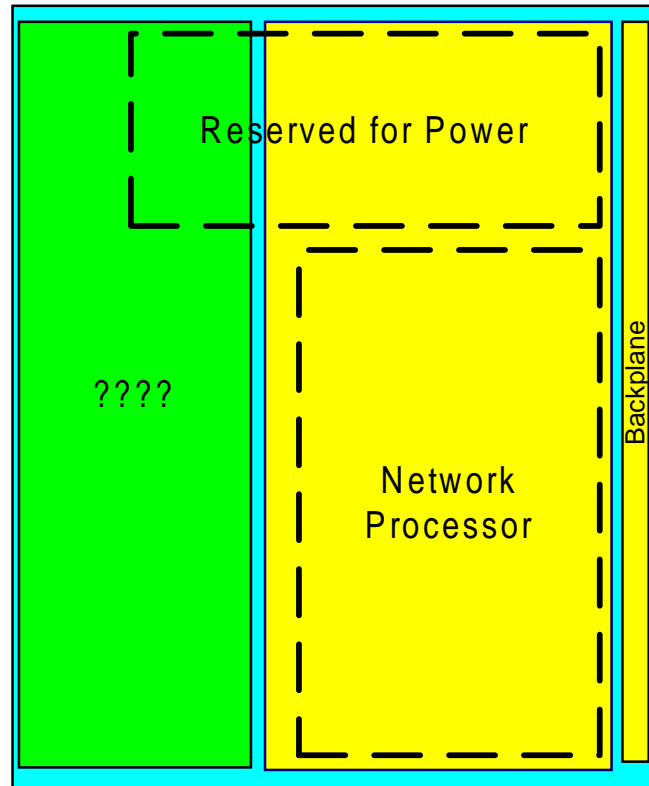

## Performance Measurement Setup - Differential

---

- Data Pattern
  - 1megabit in length using PRBS
- 8B10B Pattern
  - 8B10B Encode Data Pattern
- Scrambled Pattern
  - Scrambled Data Pattern based on proposed  $X^{58}+X^{19}+1$  Sequence

# Performance Measurement Setup - Differential

- ❑ Simulated Worst Case Differential Net in a dense Forwarding Engine design.

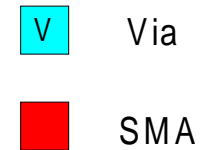
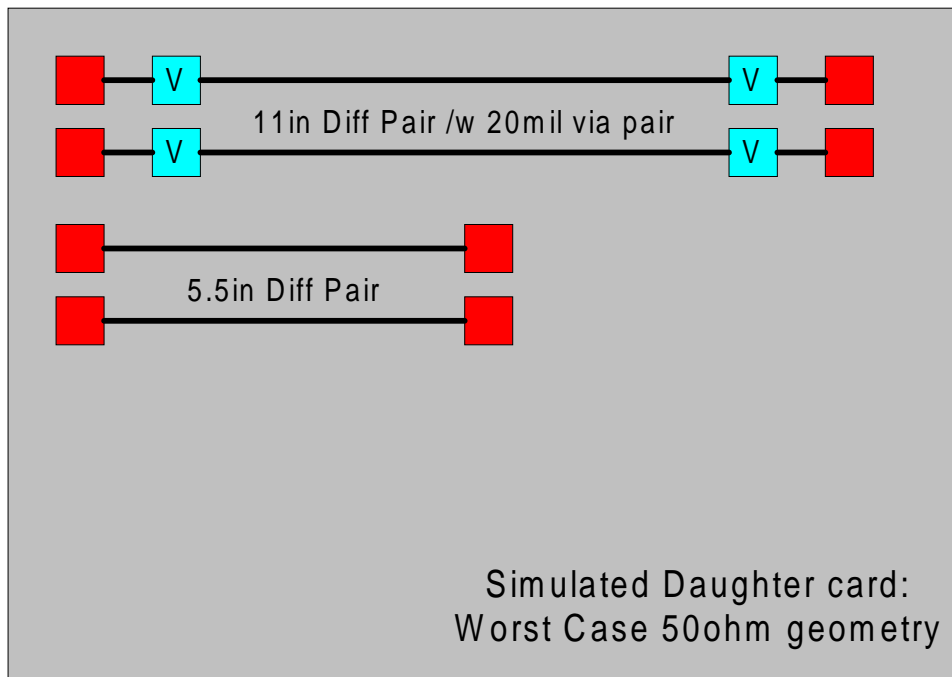

# Performance Measurement Setup - Differential

- ❑ Test setup used in performance measurements

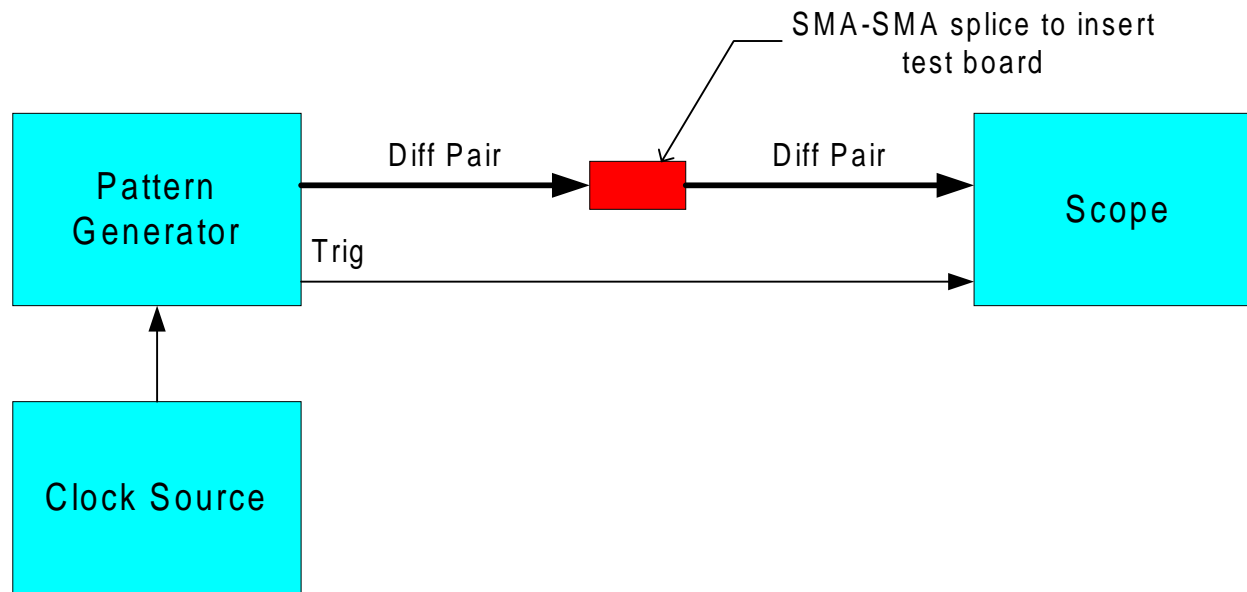



# Differential Data Eye Patterns

- ❑ Scrambled 2.5gigabit AC-coupled data with just the test setup.

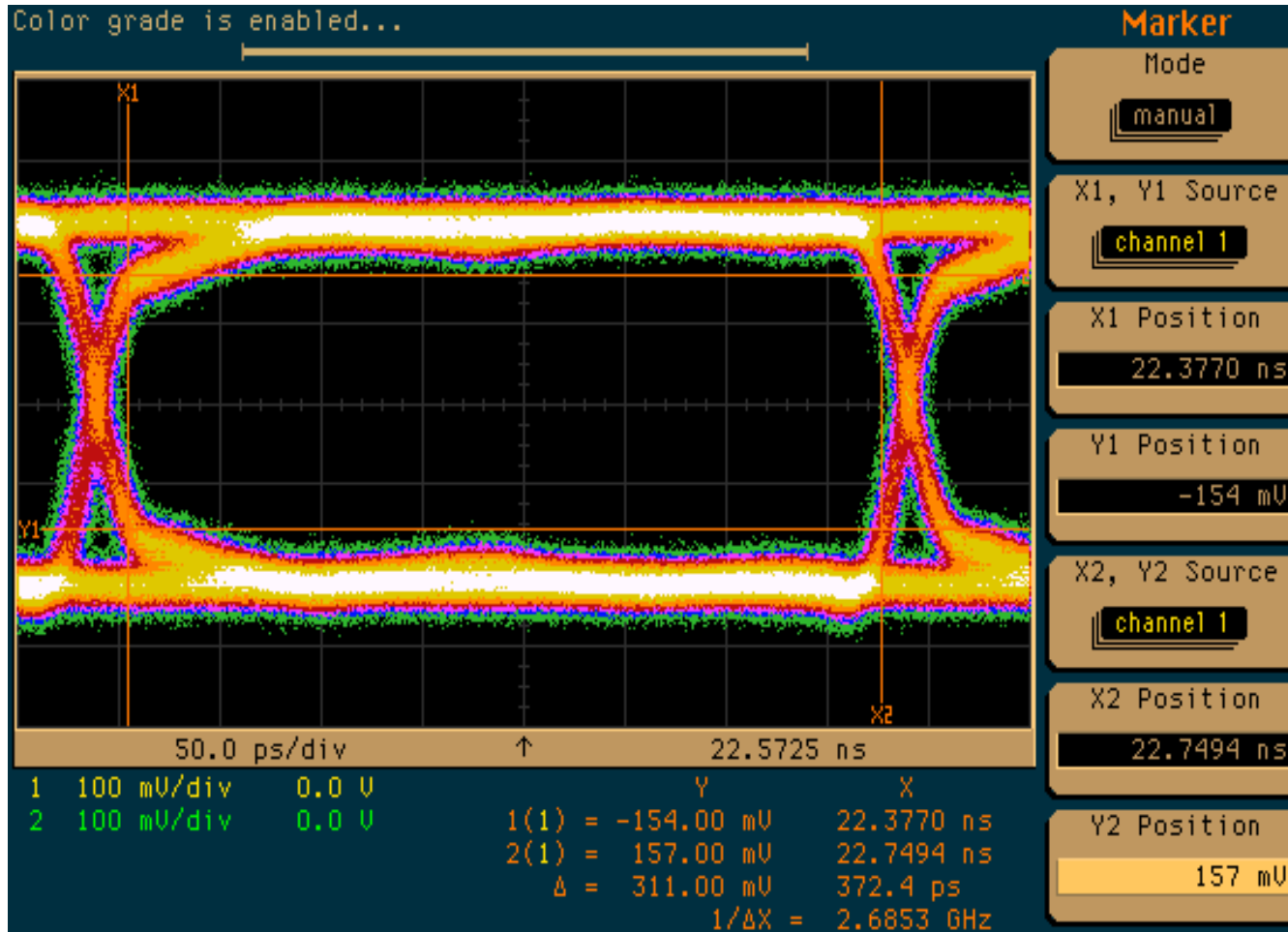

# Differential Data Eye Patterns

- ❑ 8B10B 3.125gigabit AC-coupled data with just the test setup.

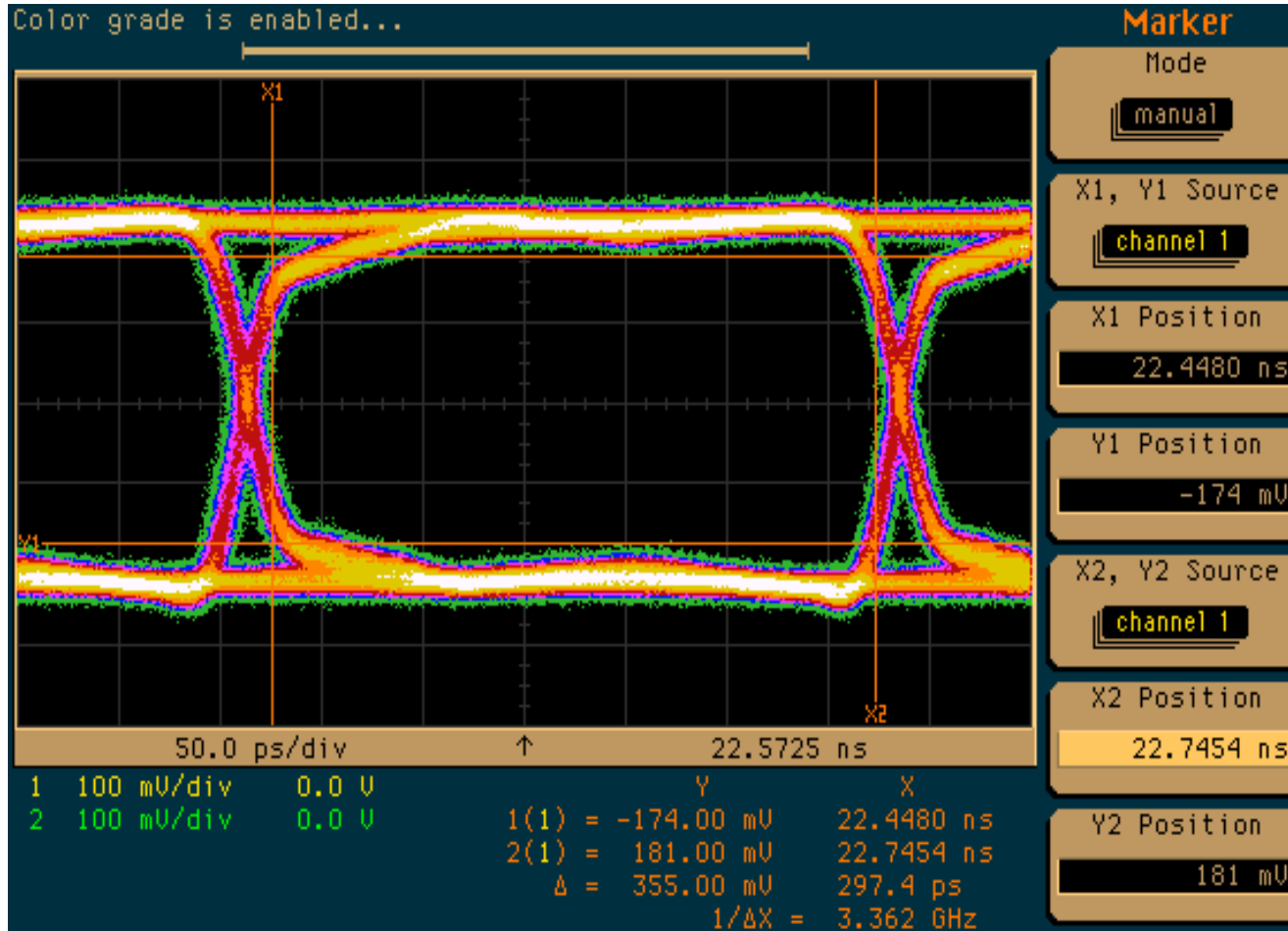

# Differential Data Eye Patterns

- ❑ Scrambled 10.0gigabit AC-coupled data with just the test setup.

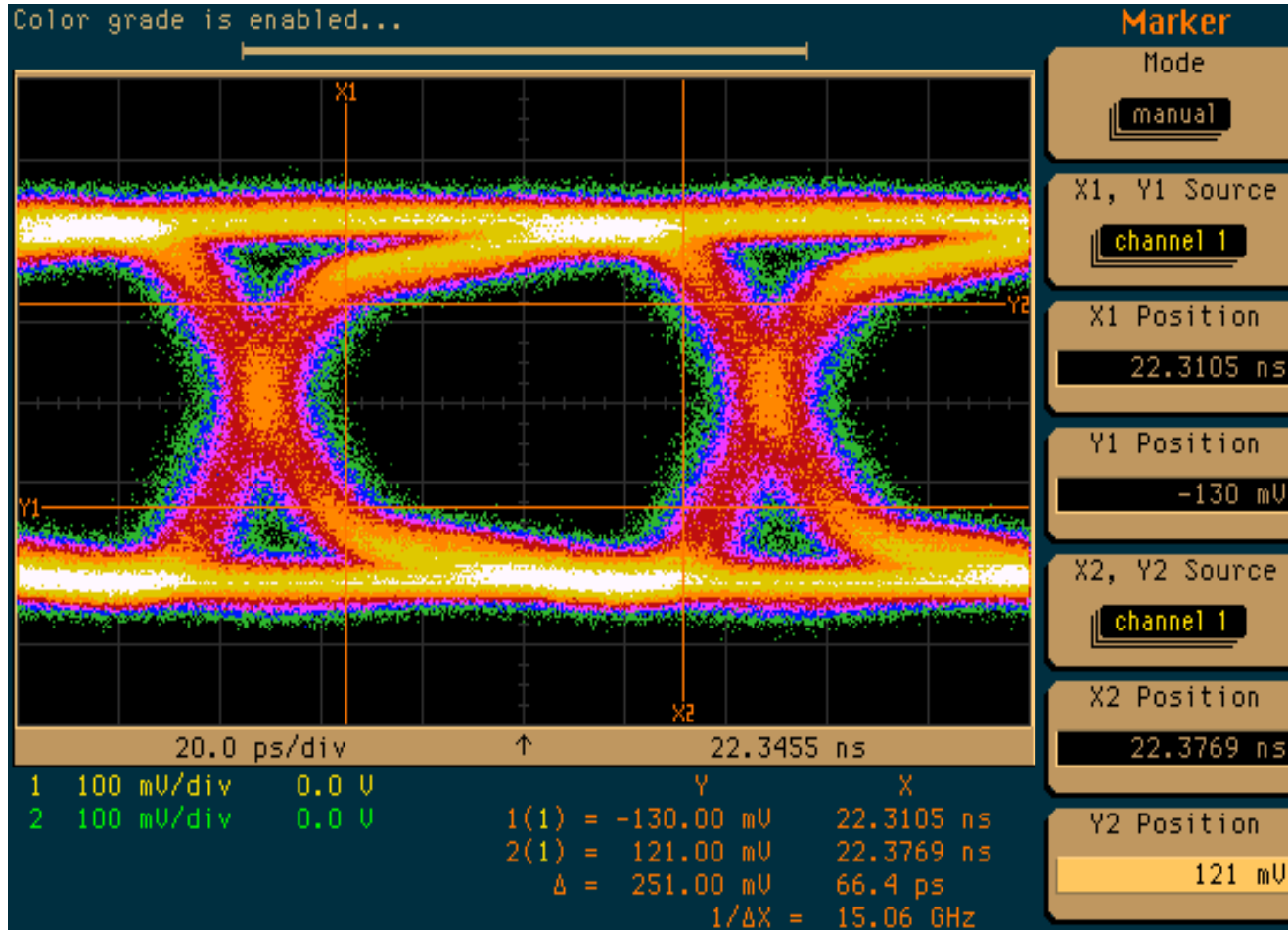

# Differential Data Eye Patterns

- ❑ Scrambled 10.3gigabit AC-coupled data with just the test setup.

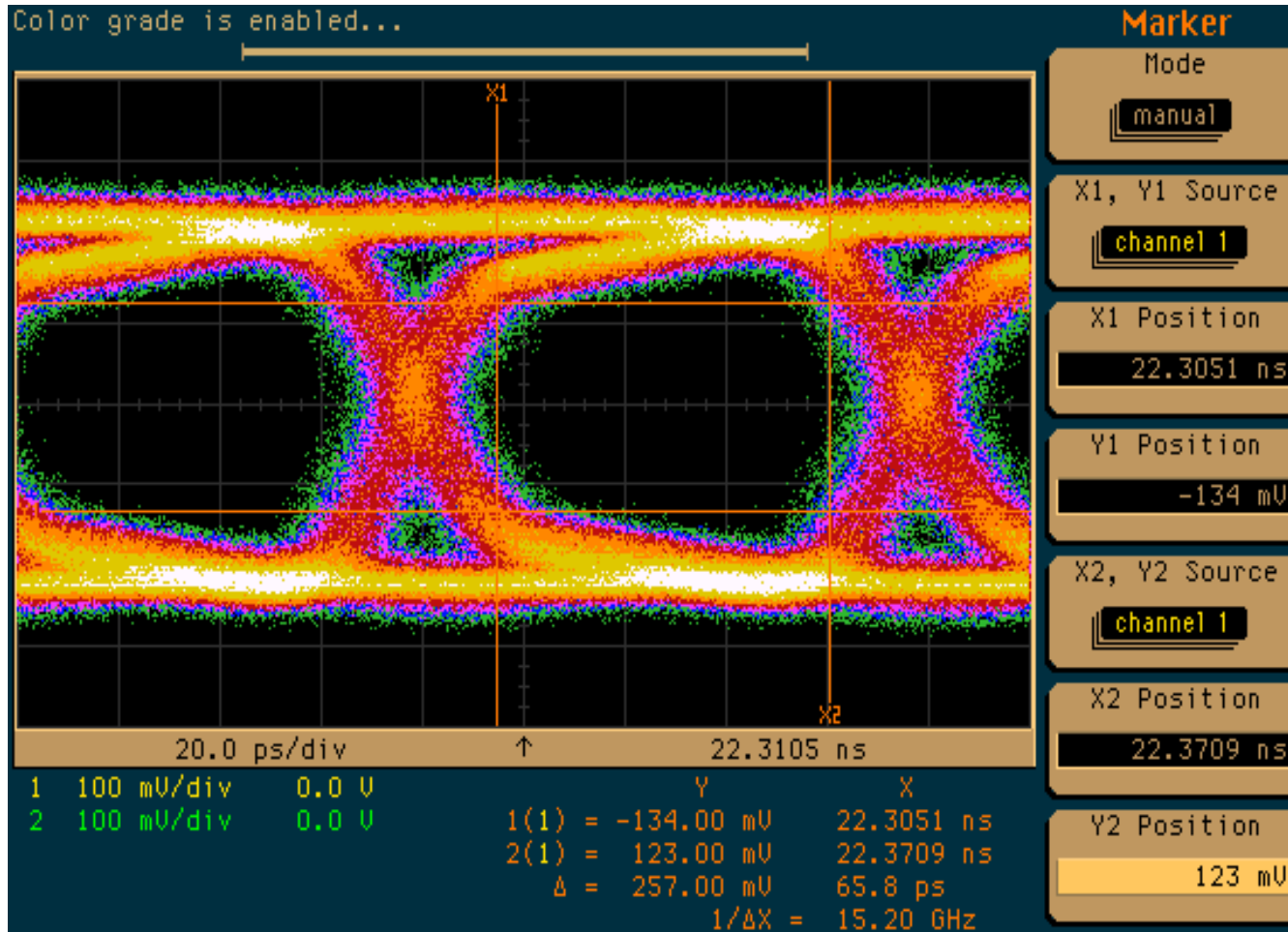

# Differential Data Eye Patterns

- ❑ 8B10B 12.5gigabit AC-coupled data with just the test setup.

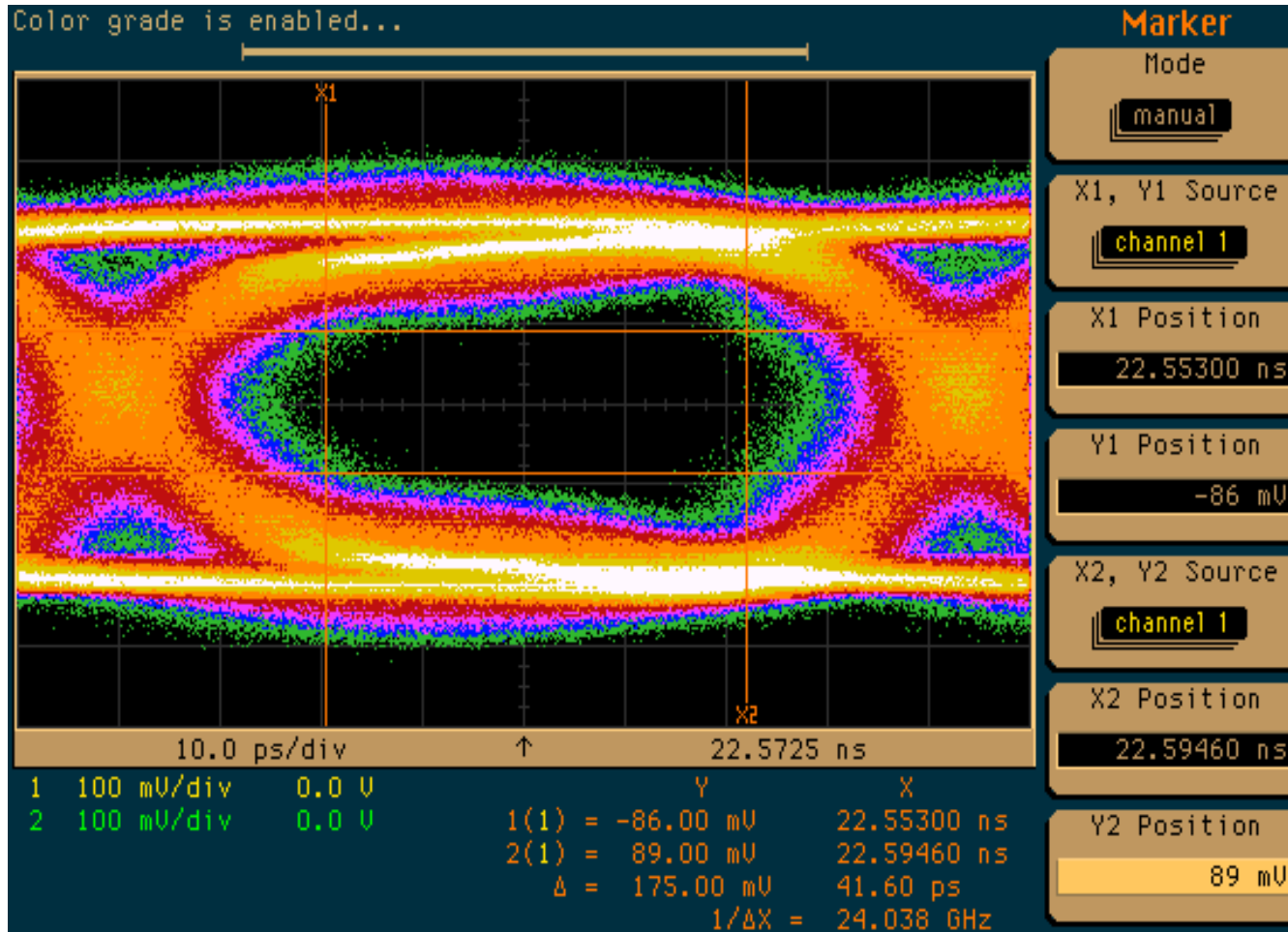

# Differential Data Eye Patterns

- ❑ Scrambled 2.5gigabit DC-coupled data with just the test setup.

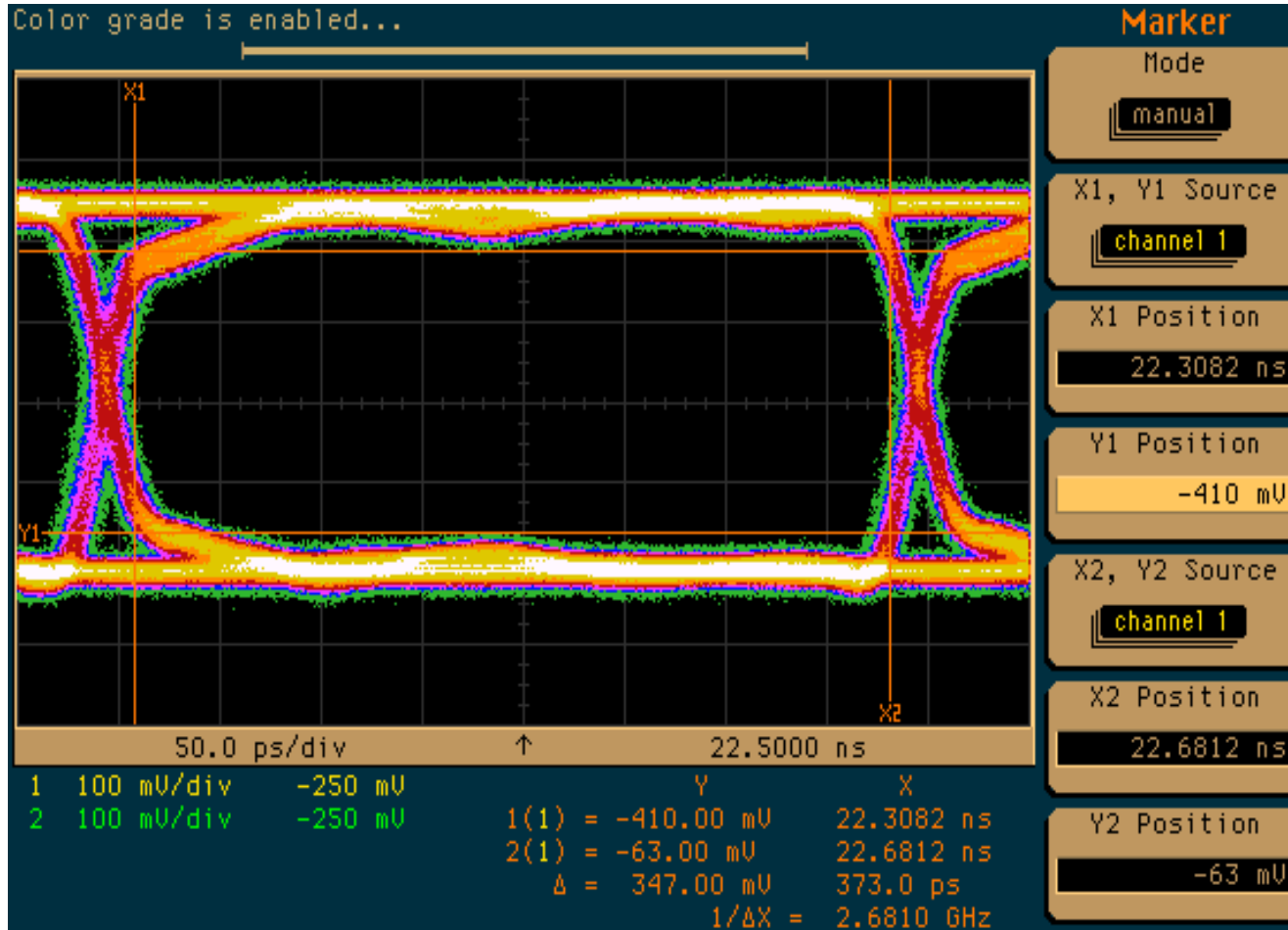

# Differential Data Eye Patterns

□ c

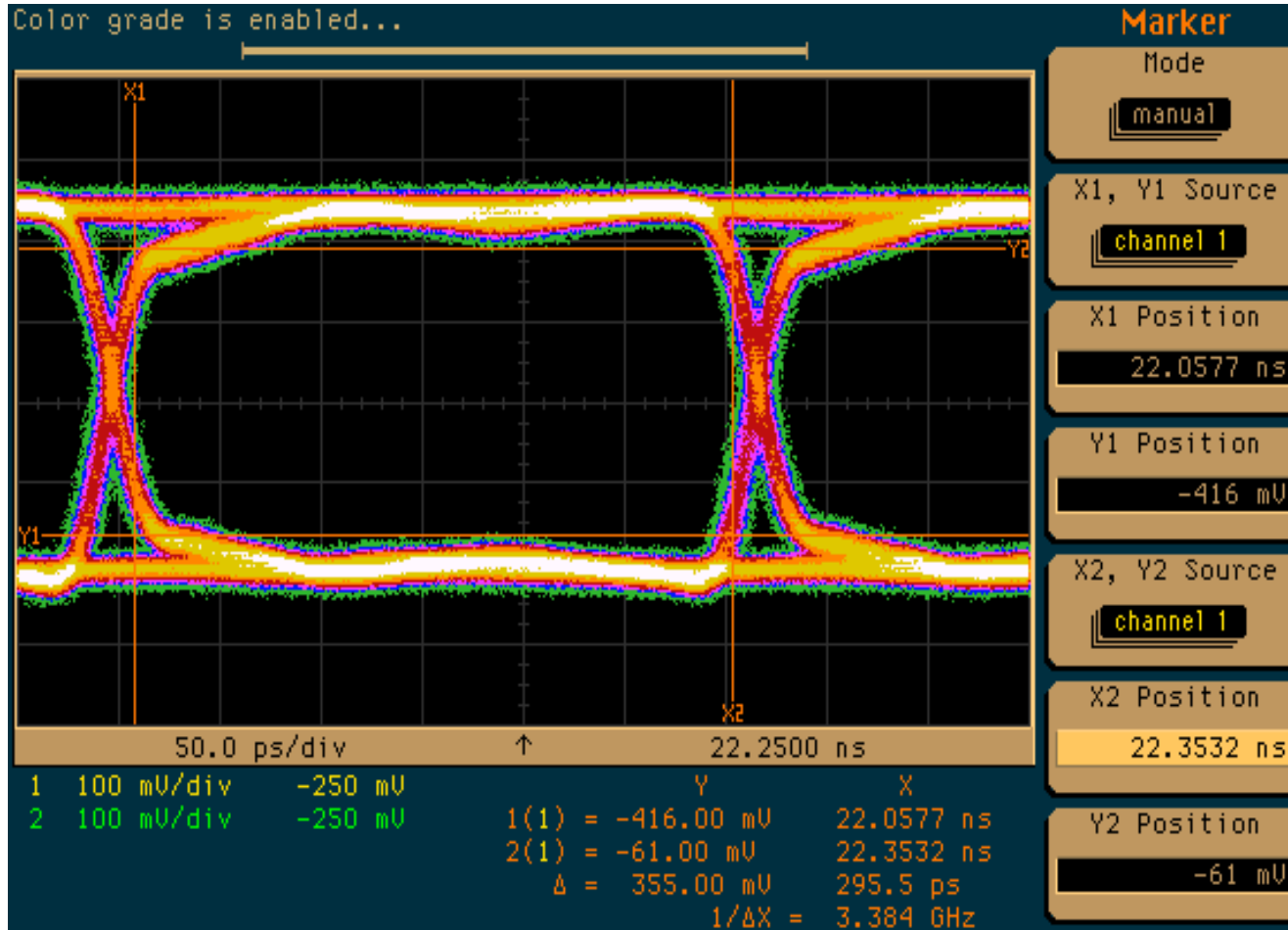



# Differential Data Eye Patterns

- ❑ Scrambled 10.0gigabit DC-coupled data with just the test setup.

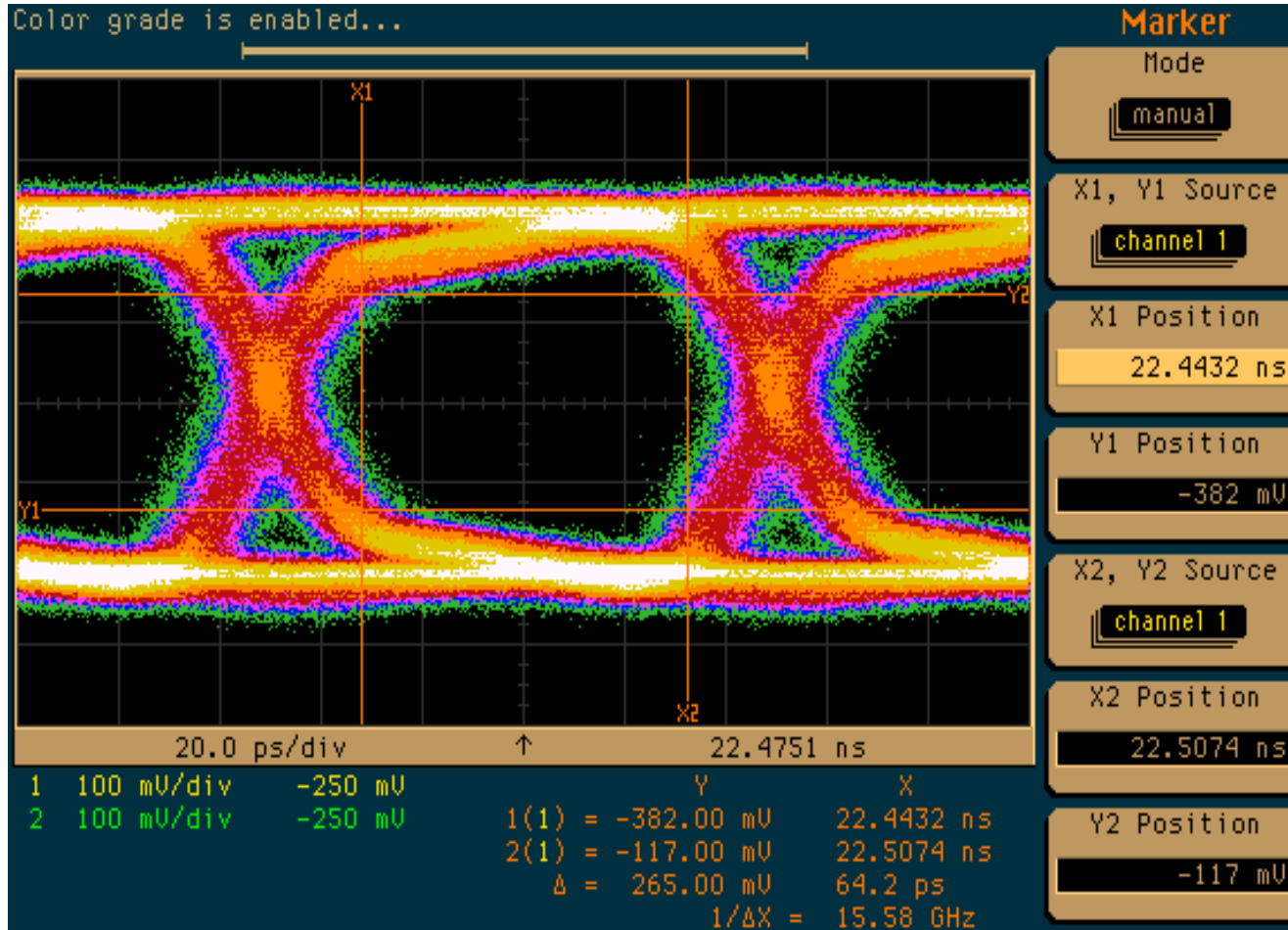



# Differential Data Eye Patterns

- ❑ Scrambled 10.3gigabit DC-coupled data with just the test setup.

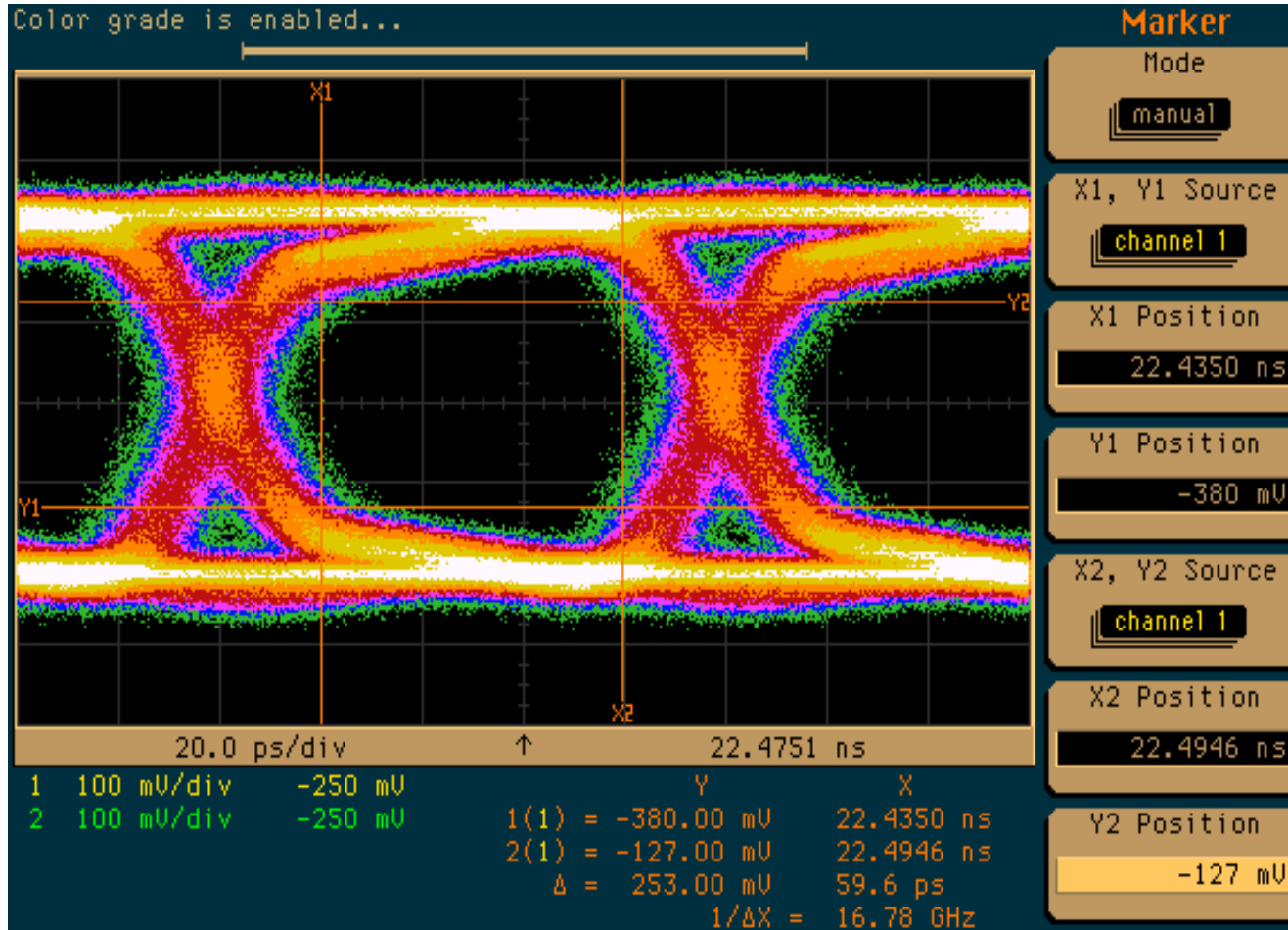

# Differential Data Eye Patterns

- ❑ 8B10B 12.5gigabit DC-coupled data with just the test setup.

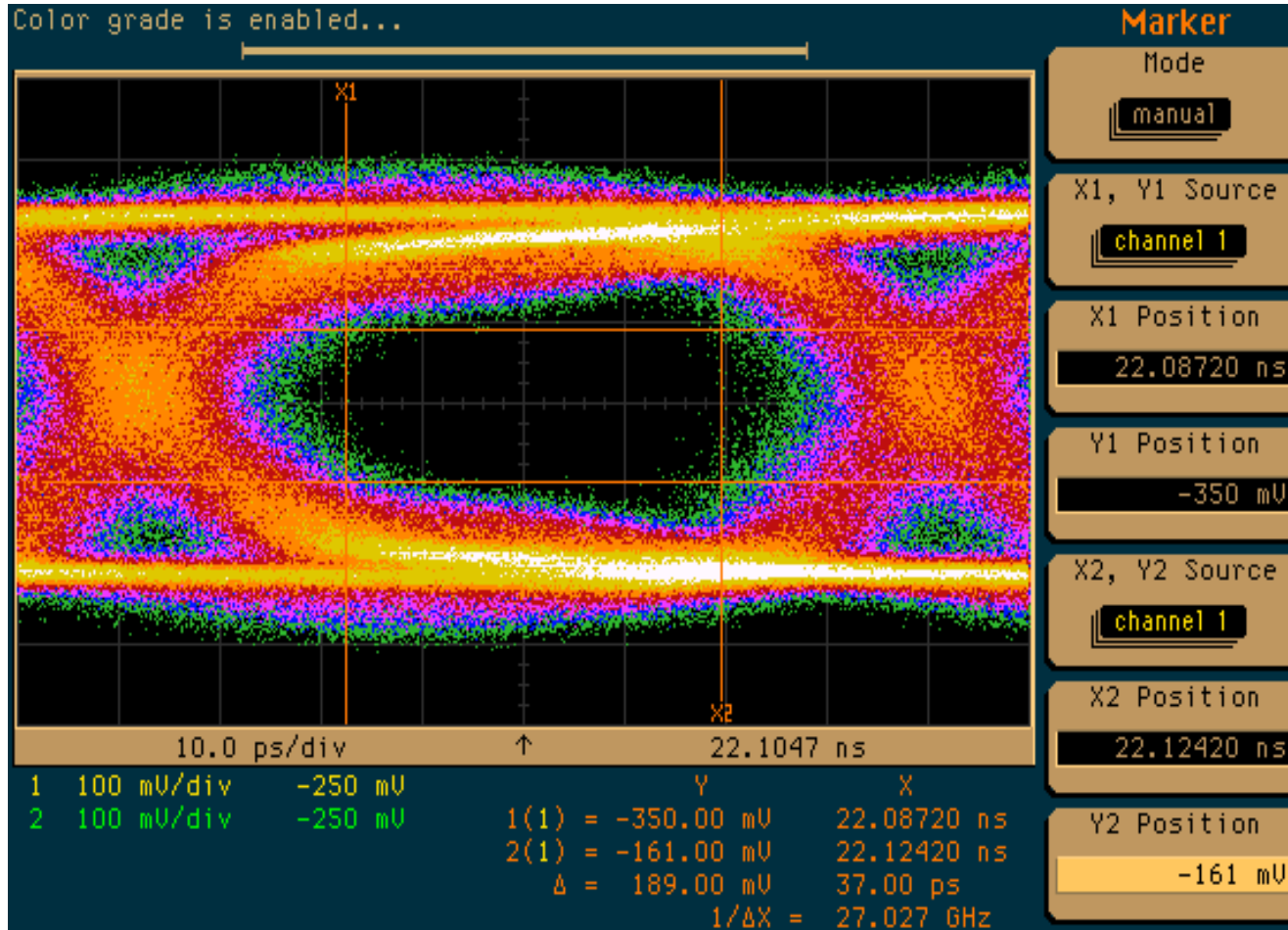

# Differential Data Eye Patterns

- ❑ Scrambled 2.5gigabit AC-coupled data with 5.5inch differential pair.

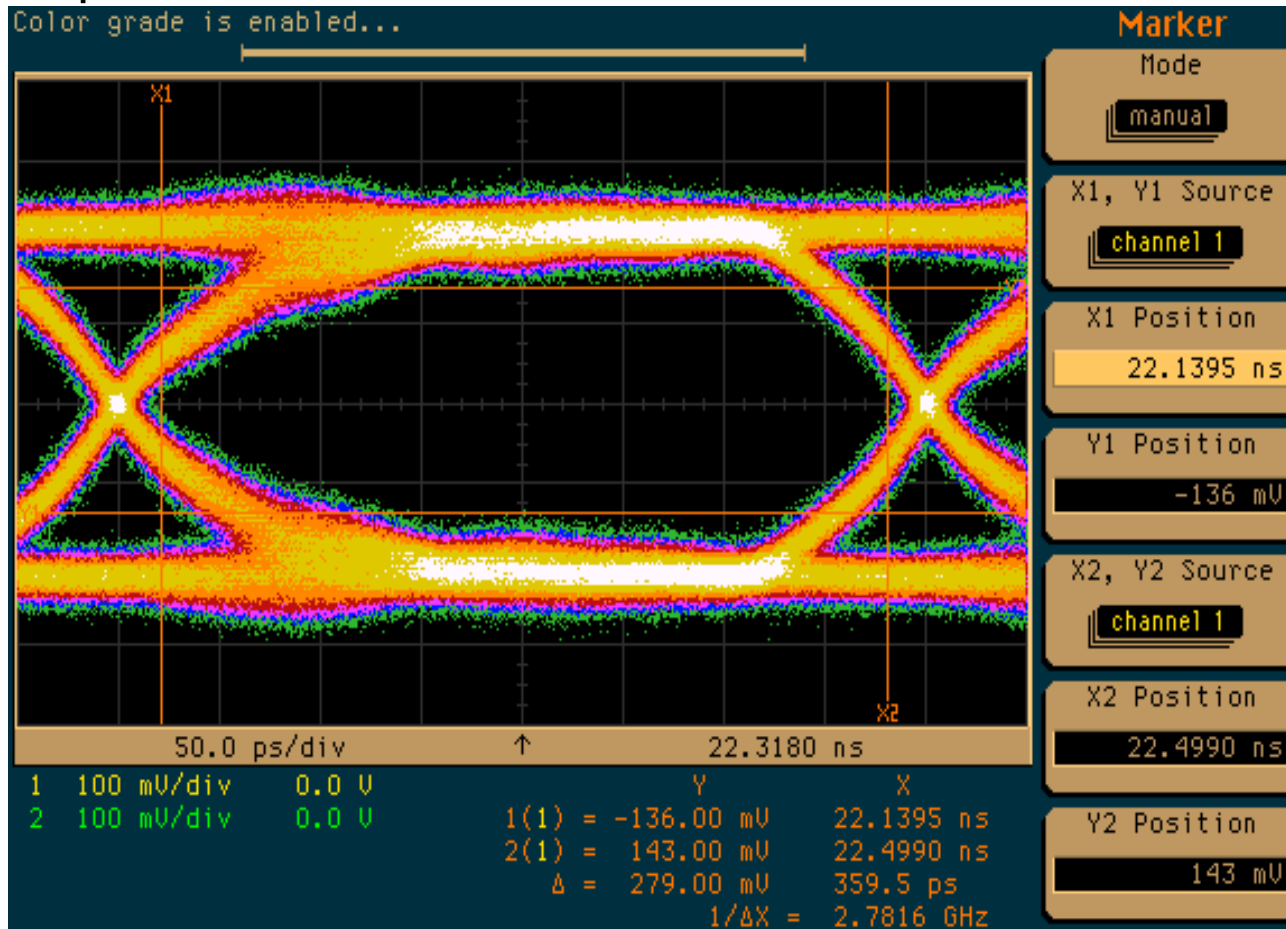

# Differential Data Eye Patterns

- ❑ 8B10B 3.125gigabit AC-coupled data with 5.5inch differential pair.

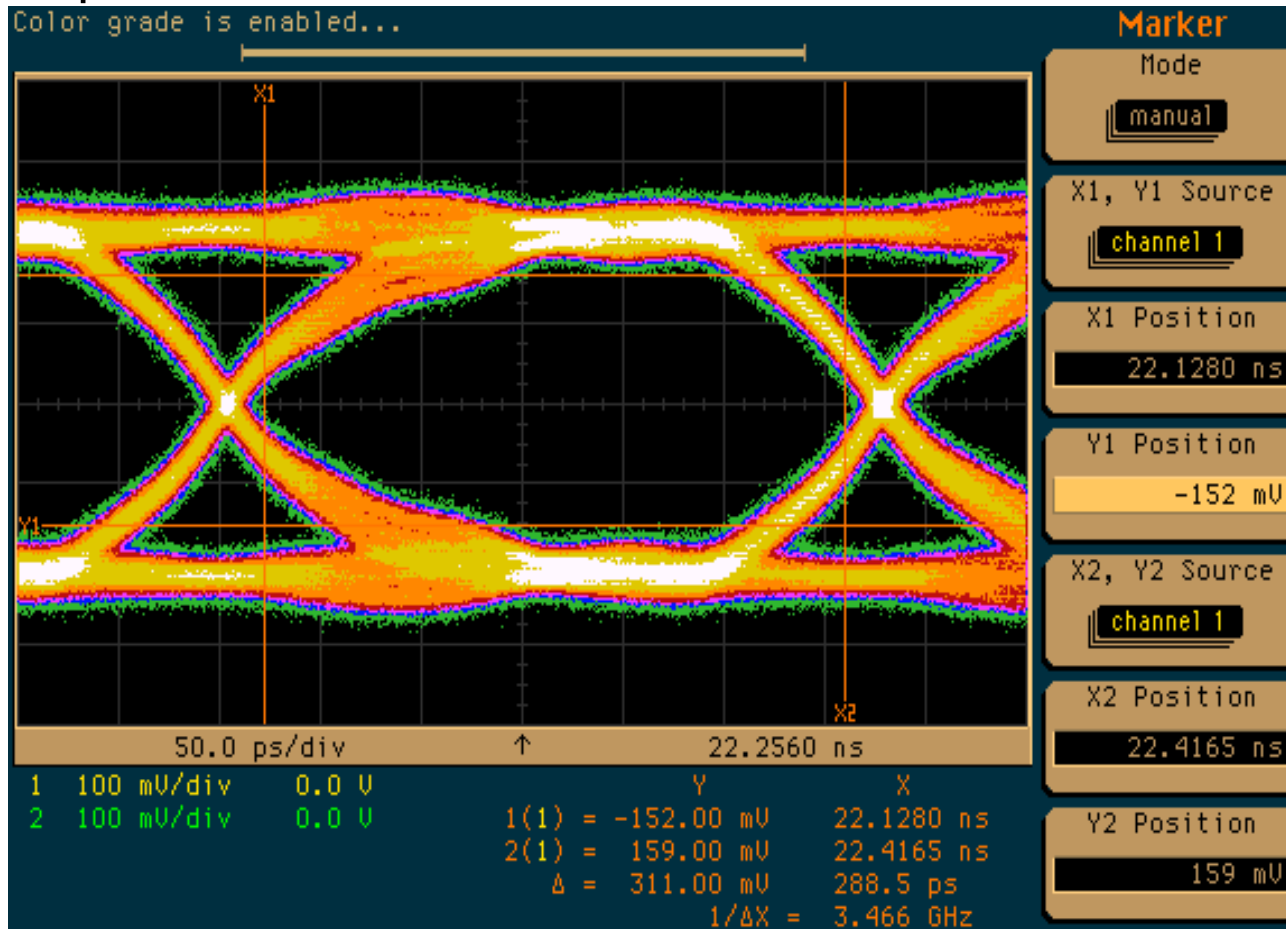

# Differential Data Eye Patterns

- ❑ Scrambled 10.0gigabit AC-coupled data with 5.5inch differential pair.

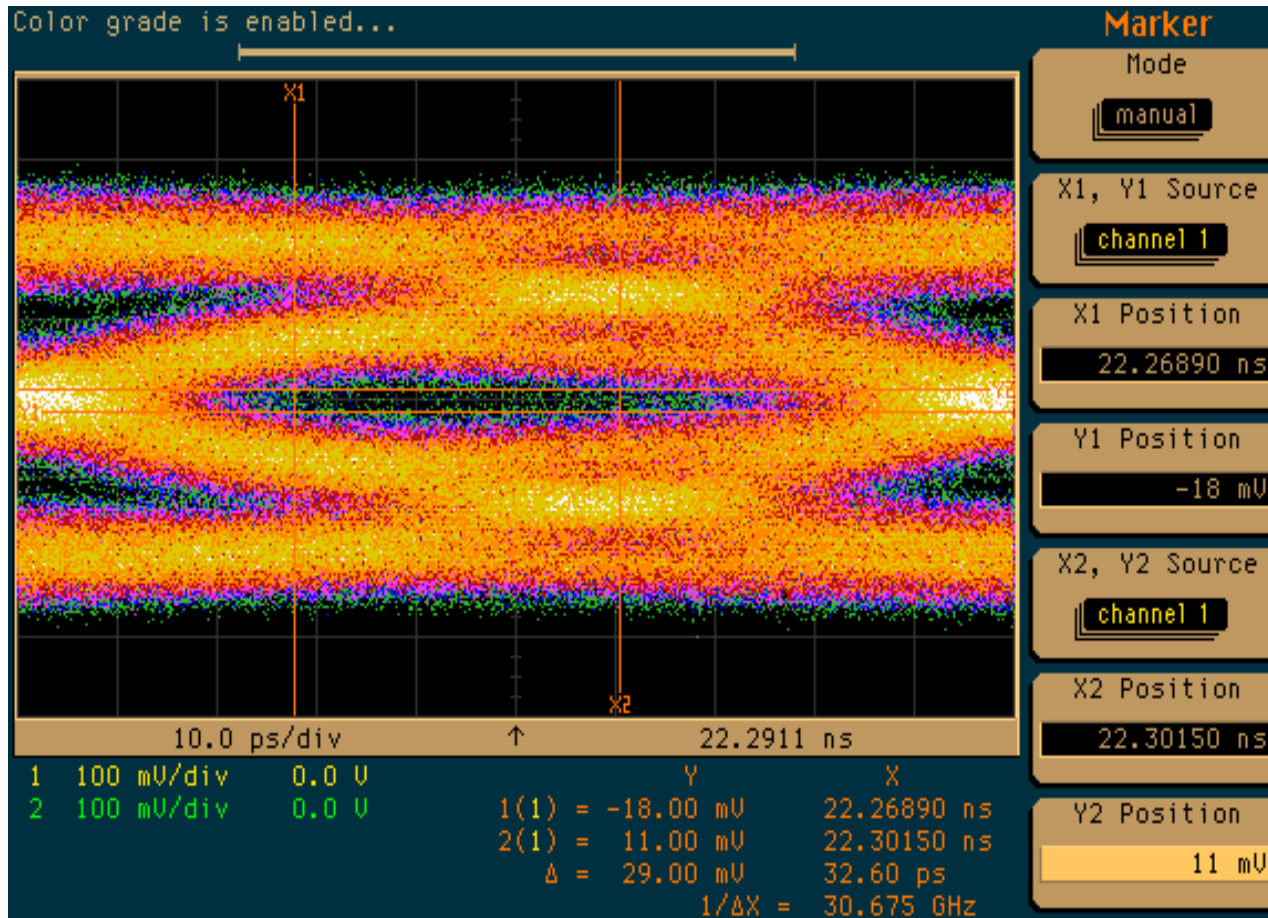



# Differential Data Eye Patterns

- ❑ Scrambled 10.3gigabit AC-coupled data with 5.5inch differential pair.

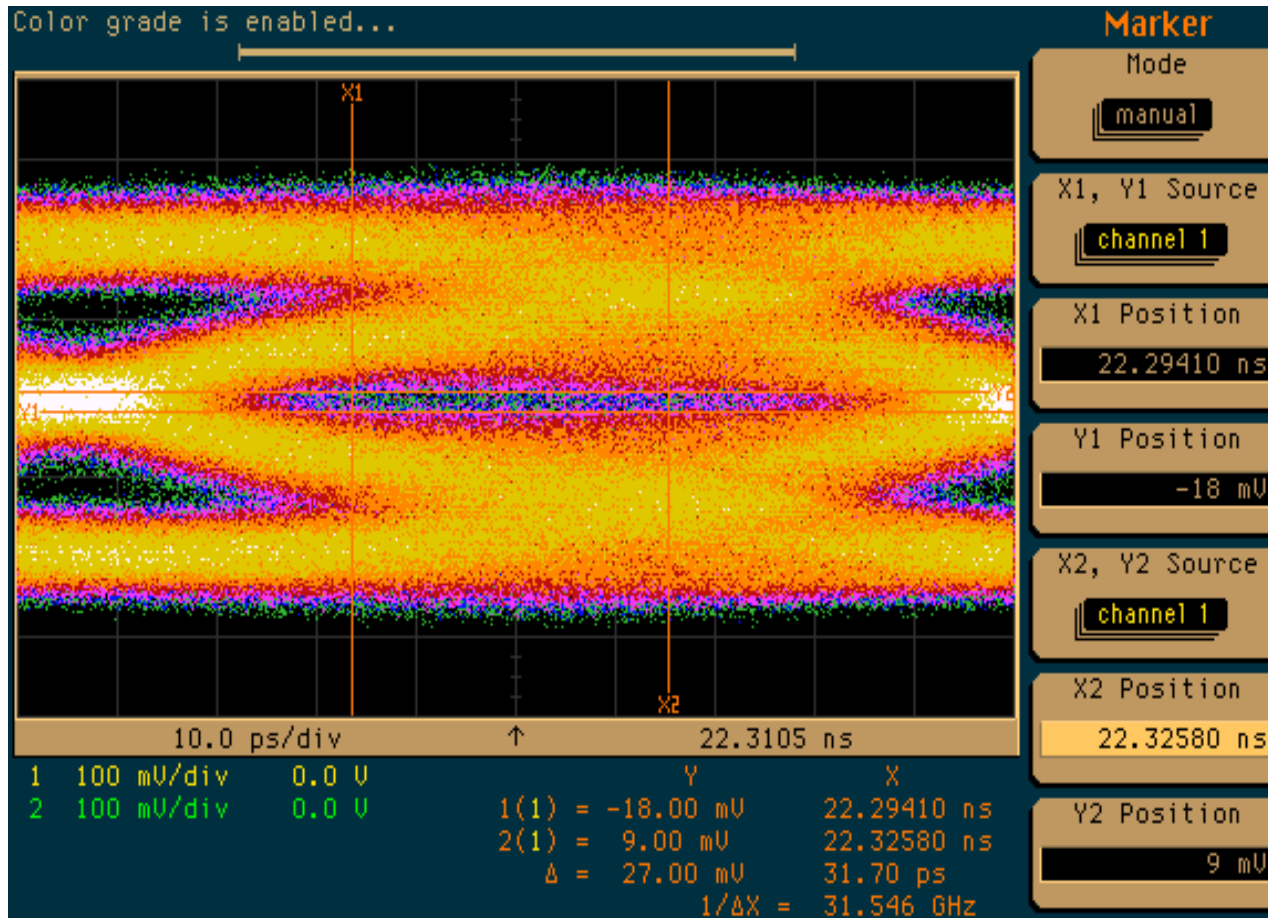

# Differential Data Eye Patterns

- ❑ 8B10B 12.5gigabit AC-coupled data with 5.5inch differential pair.

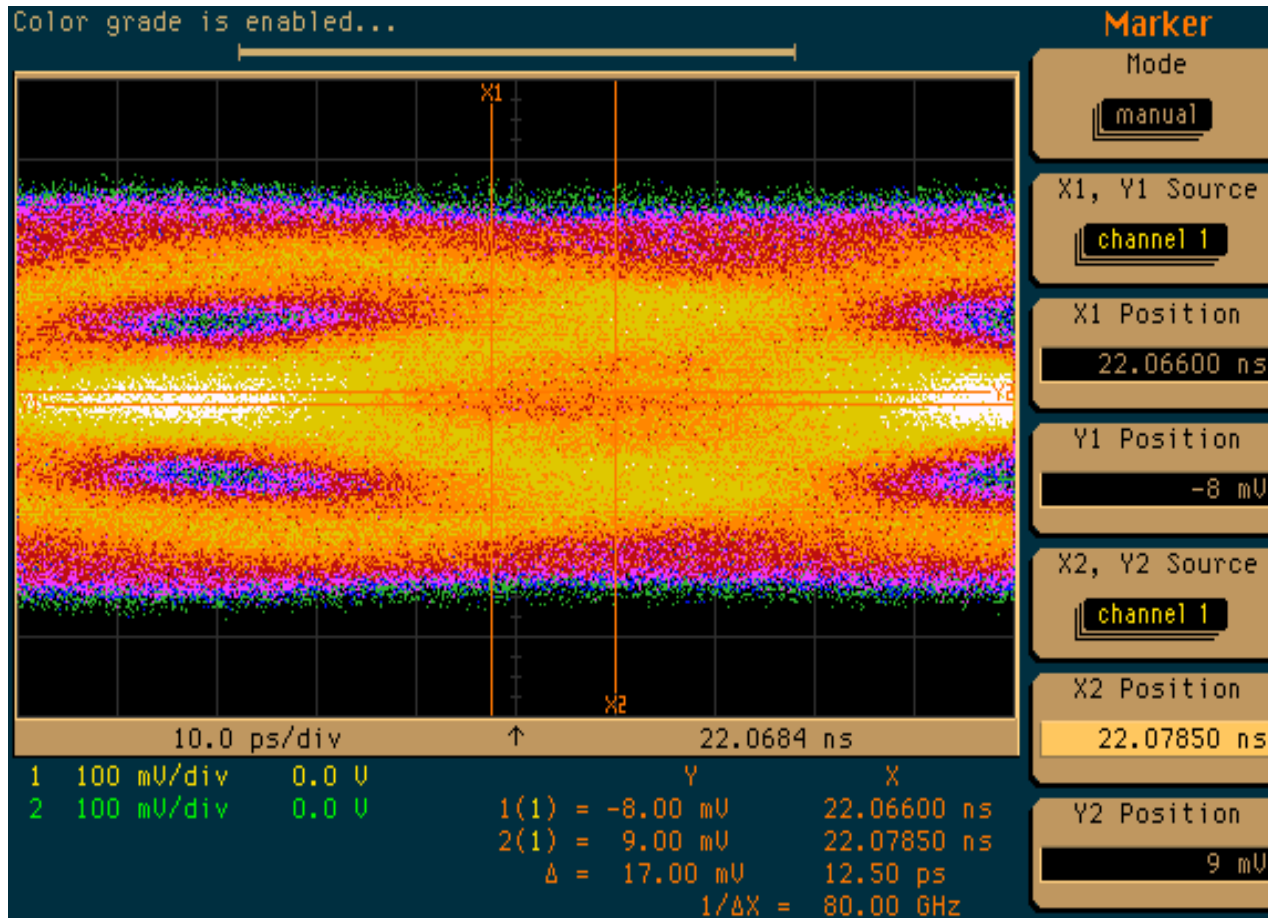

## Differential Data Eye Patterns

- ❑ Scrambled 2.5gigabit AC-coupled data with 11inch differential pair and two VIAs.

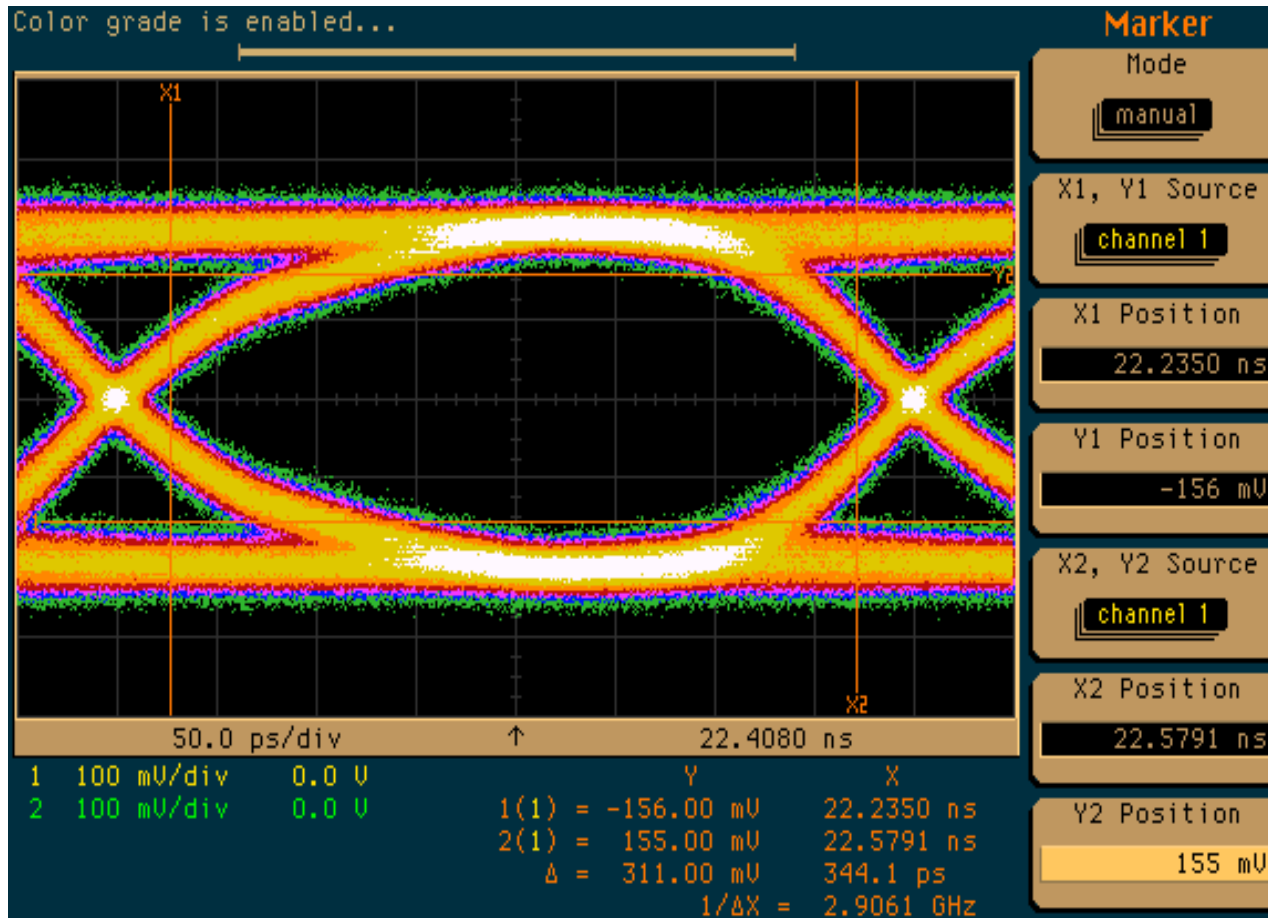



# Differential Data Eye Patterns

- ❑ 8B10B 3.125gigabit AC-coupled data with 11inch differential pair and two VIAs.

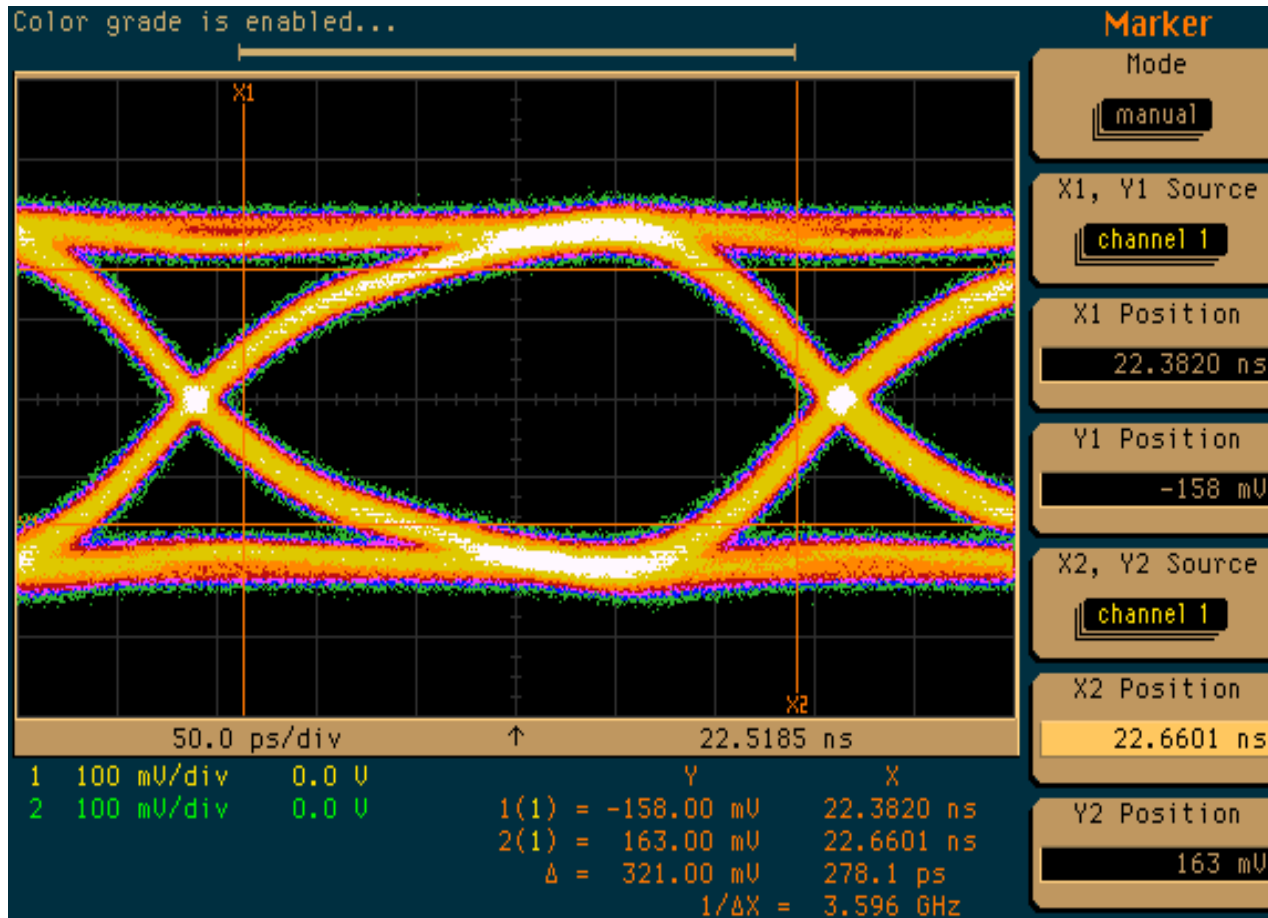

# Differential Data Eye Patterns

- ❑ Scrambled 2.5gigabit AC-coupled data with 22inch differential pair and four VIAs.

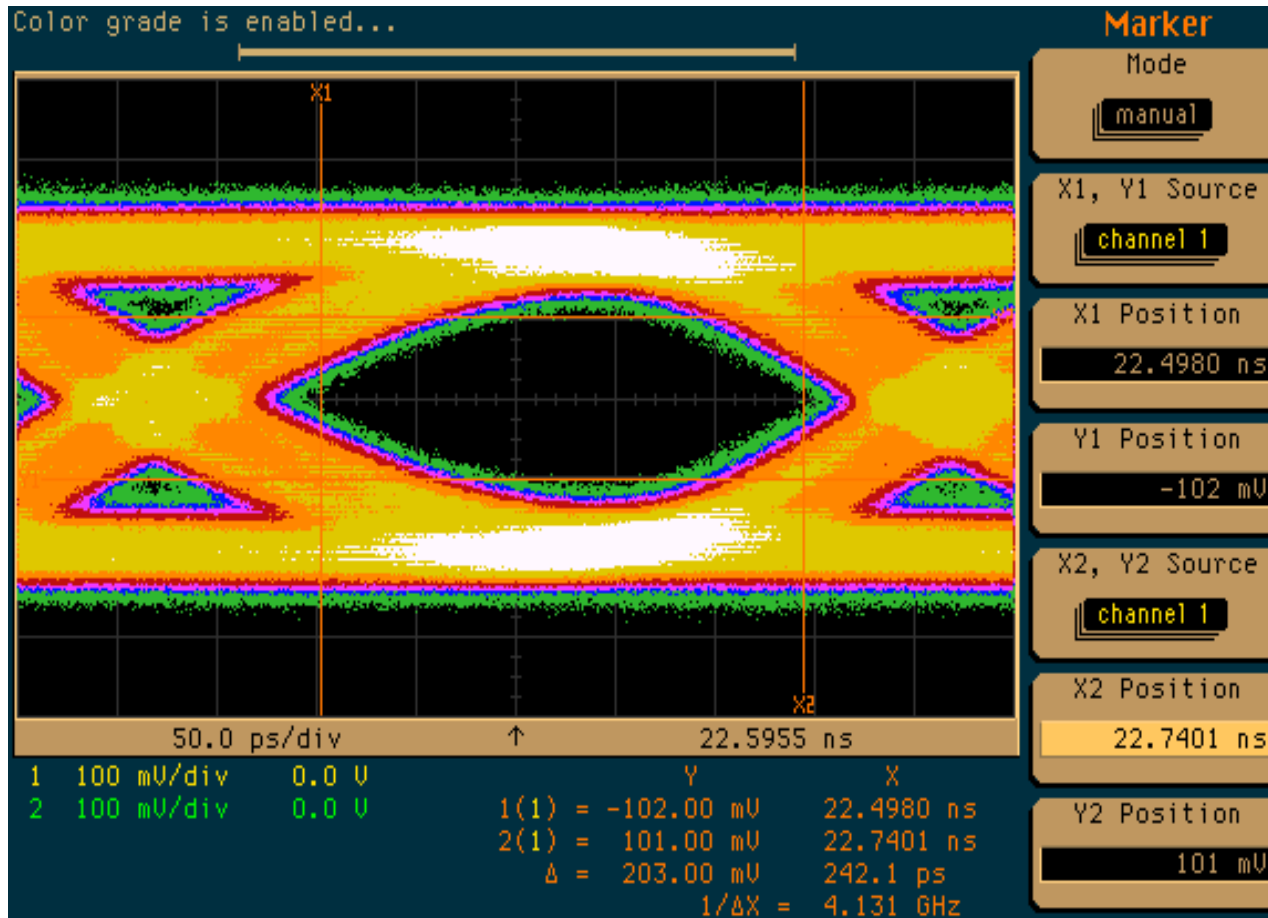

# Differential Data Eye Patterns

- ❑ 8B10B 3.125gigabit AC-coupled data with 22inch differential pair and four VIAs.

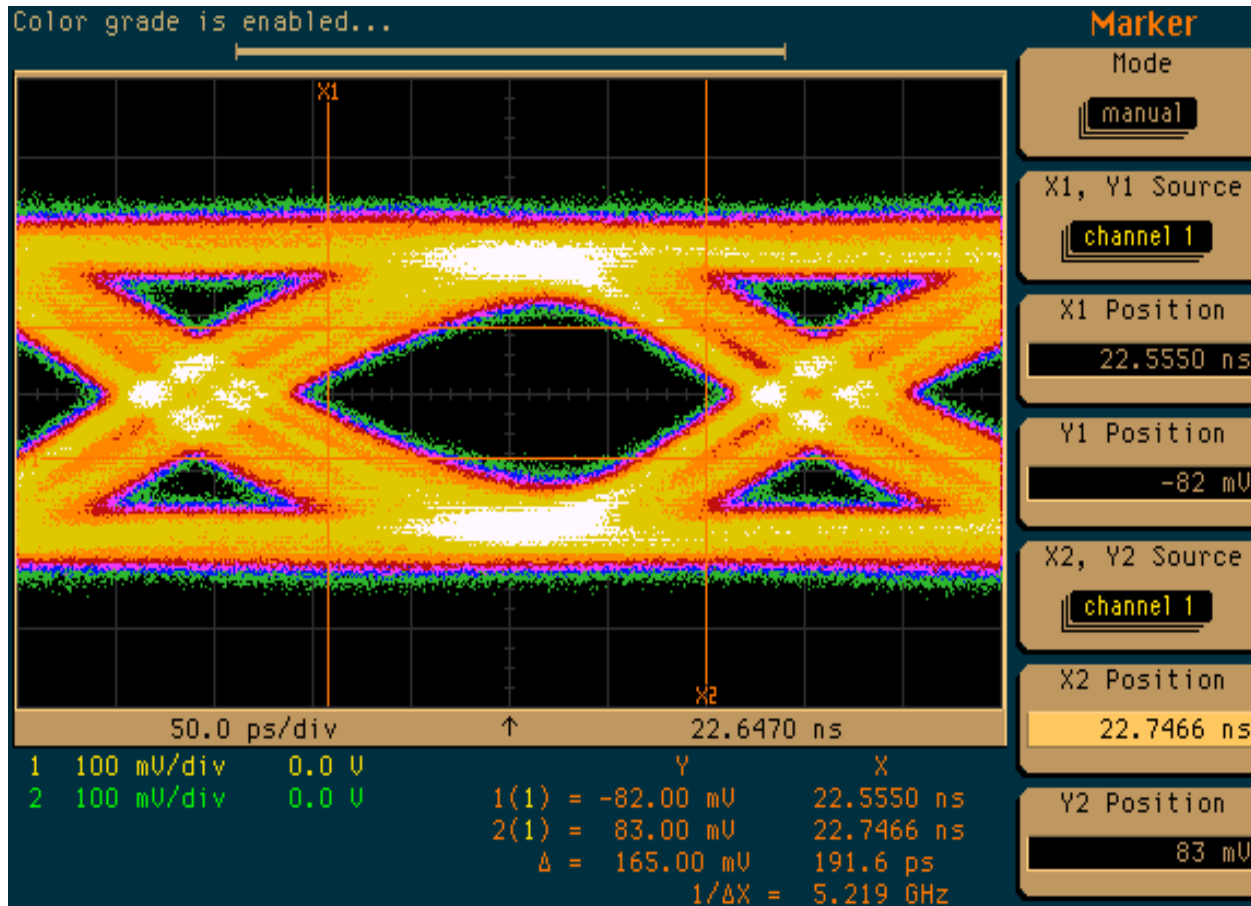

# Differential Data Eye Patterns

- ❑ Scrambled 2.5gigabit DC-coupled data with 5.5inch differential pair.

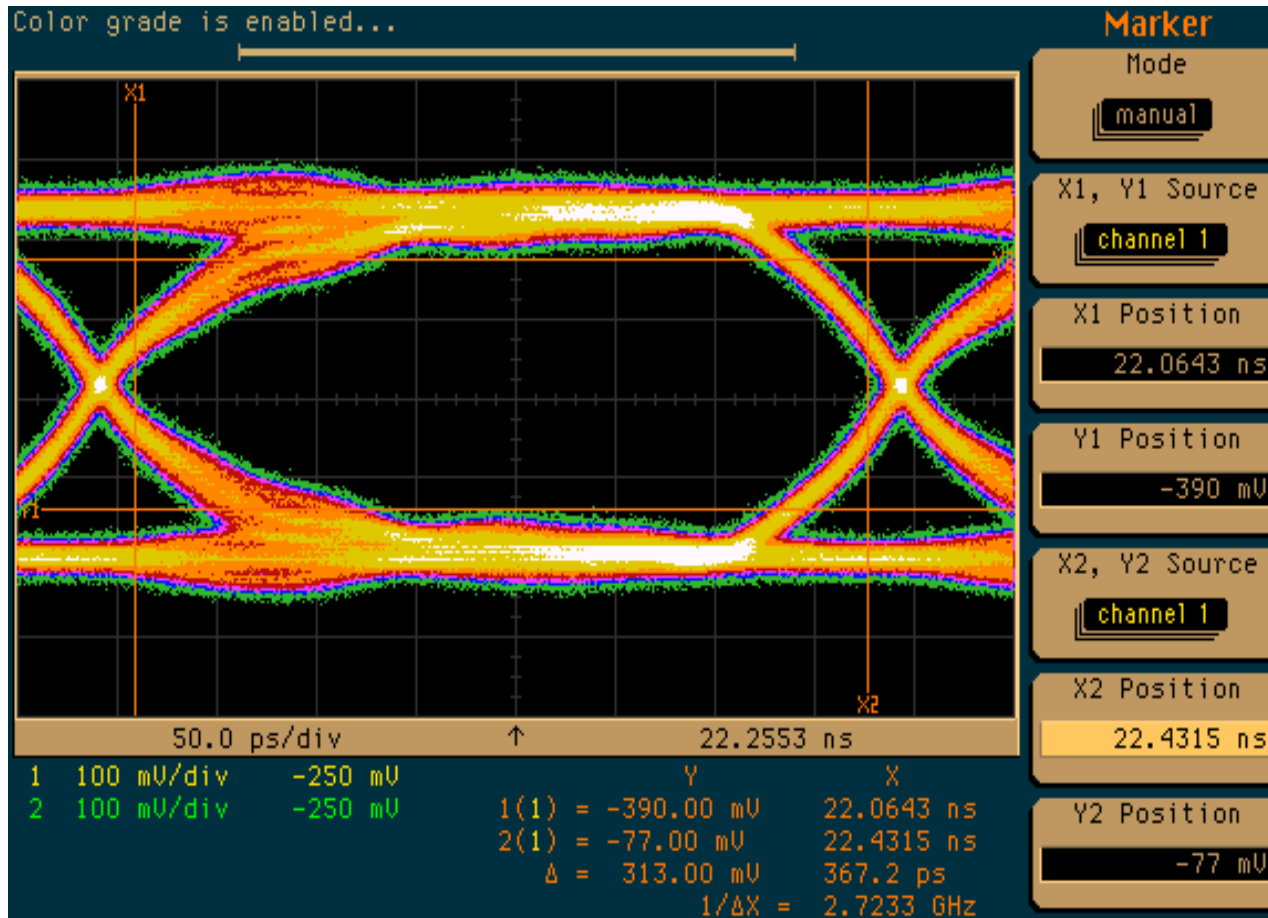

# Differential Data Eye Patterns

- ❑ 8B10B 3.125gigabit DC-coupled data with 5.5inch differential pair.

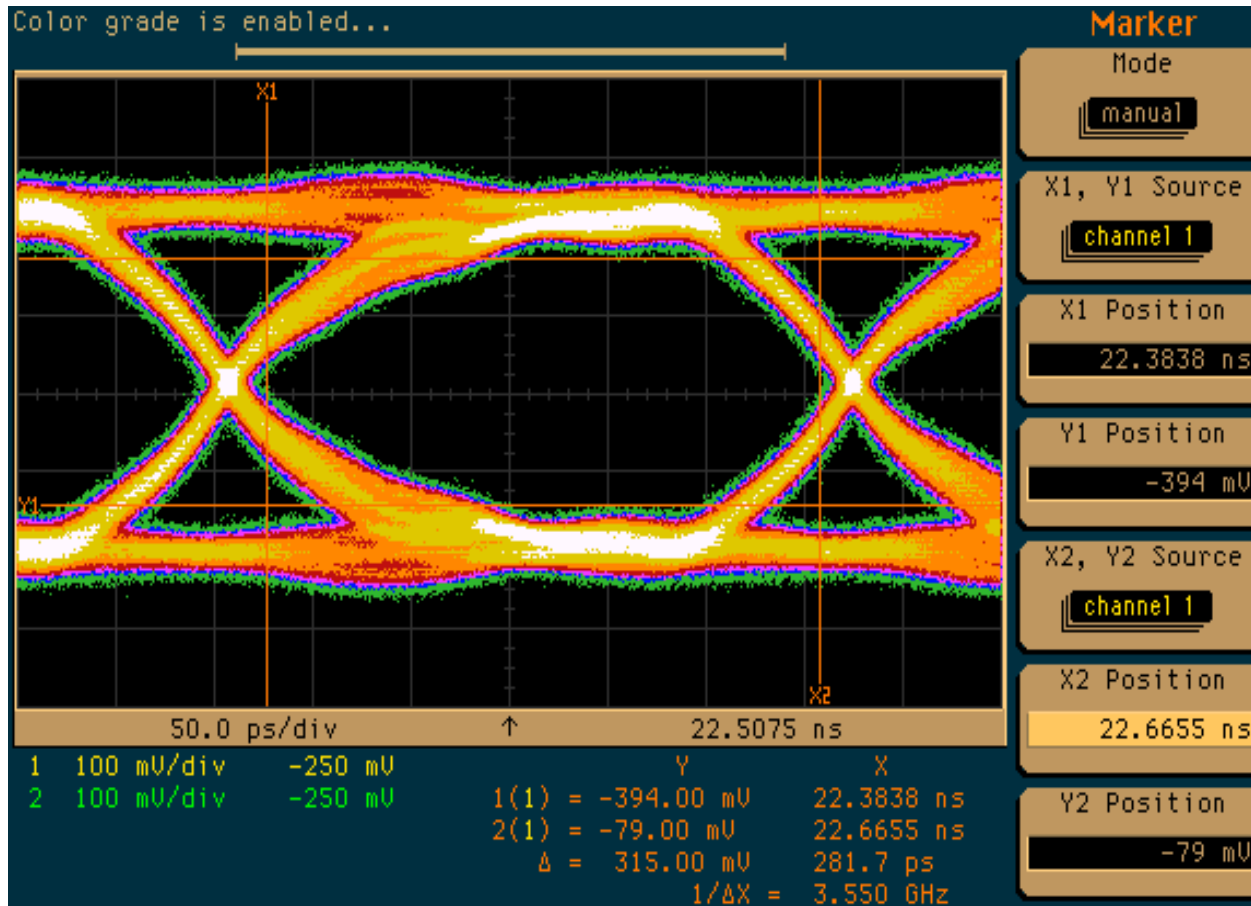

# Differential Data Eye Patterns

- ❑ Scrambled 10.0gigabit DC-coupled data with 5.5inch differential pair.

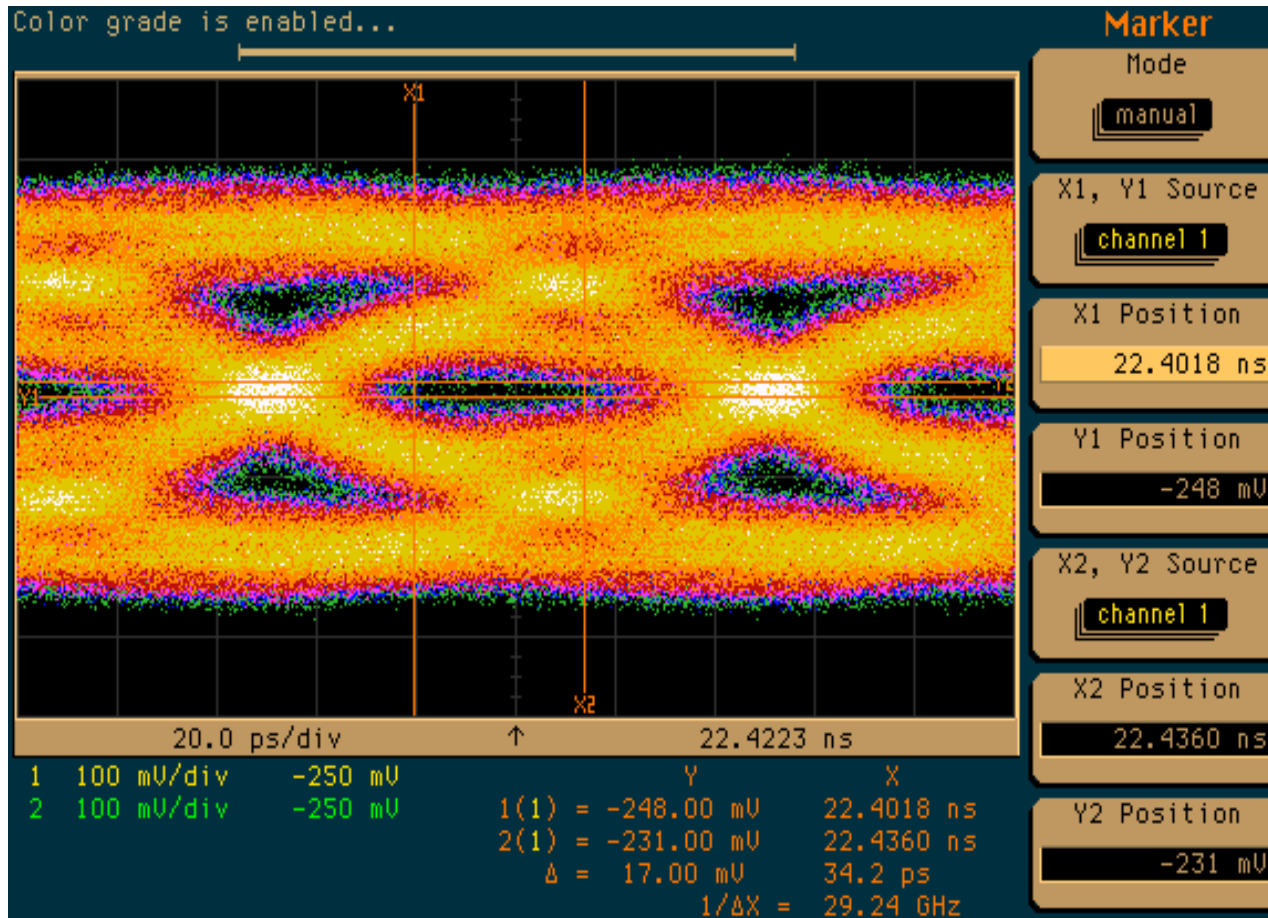



# Differential Data Eye Patterns

- ❑ Scrambled 10.3gigabit DC-coupled data with 5.5inch differential pair.

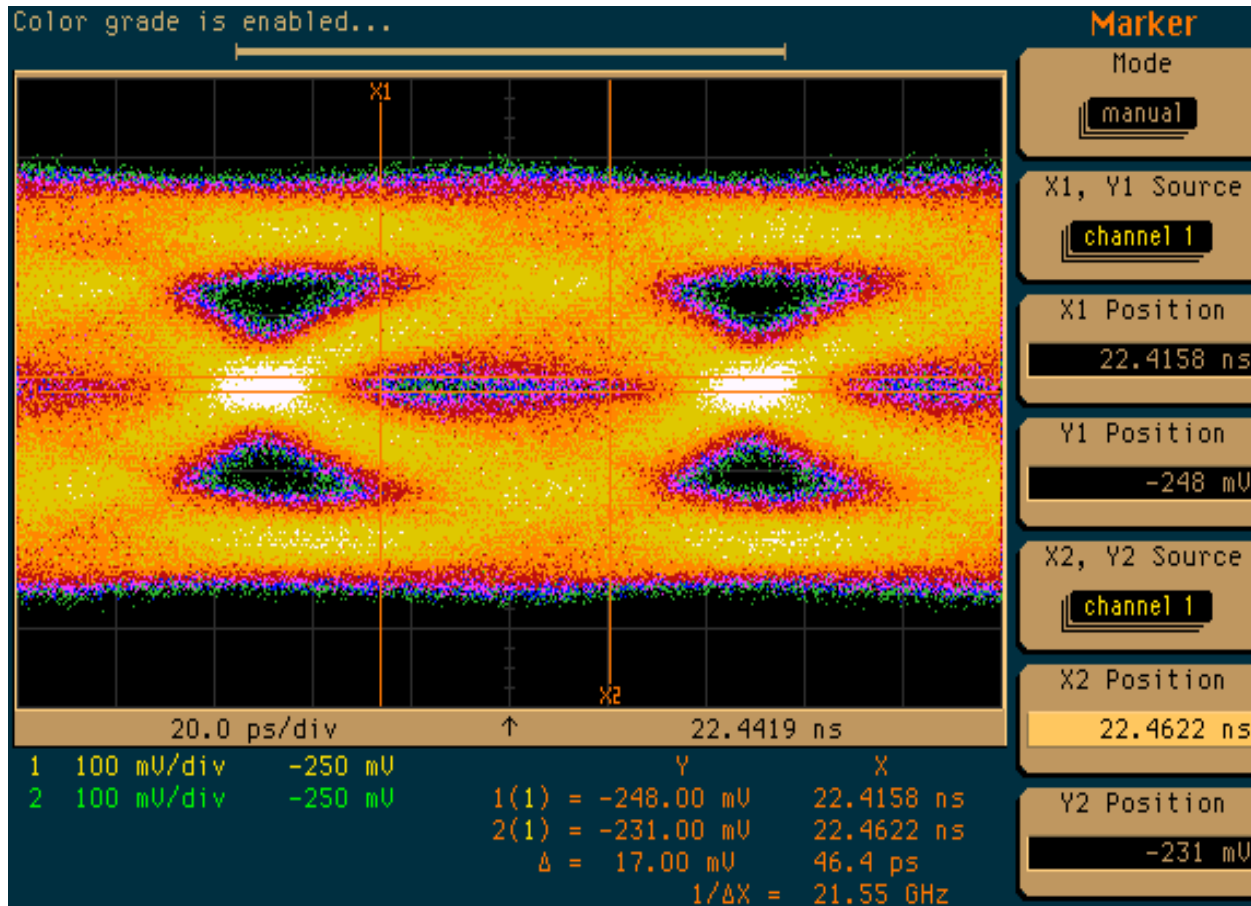

# Differential Data Eye Patterns

- ❑ 8B10B 12.5gigabit DC-coupled data with 5.5inch differential pair.

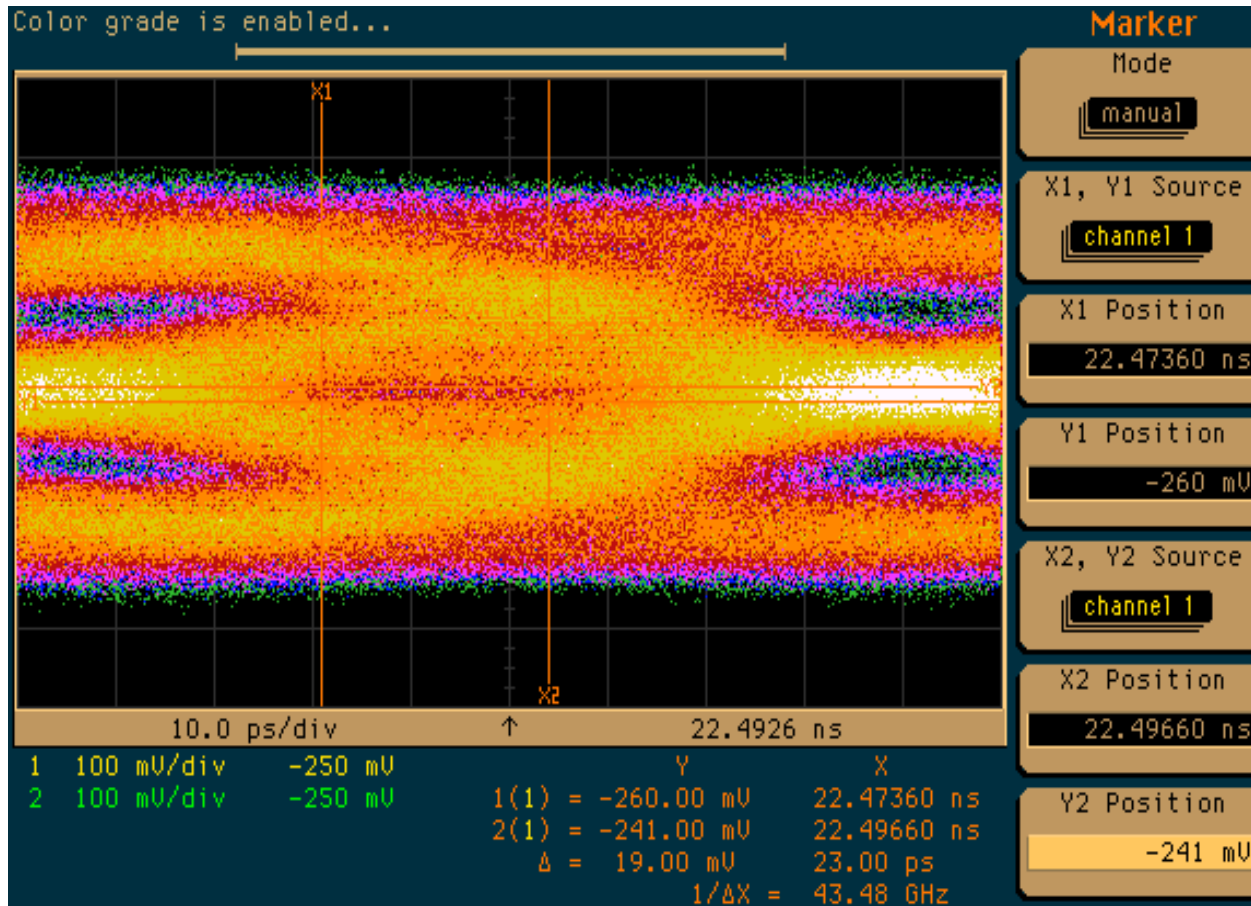



# Differential Data Summary

	Equipment		5.5inch Length		11inch Length		22inch Length	
	Amp in mv	Width in ps	Amp in mv	Width in ps	Amp in mv	Width in ps	Amp in mv	Width in ps
<b>DC Coupled</b>								
<b>Scrambled 2.5</b>	347	373	313	367				
<b>8B10B 3.125</b>	355	296	315	282				
<b>Scrambled 10.0</b>	265	64	Barely Open					
<b>Scrambled 10.3</b>	253	60	Barely Closed					
<b>8B10B 12.5</b>	189	37	Closed					
<b>AC Coupled</b>								
<b>Scrambled 2.5</b>	311	372	279	360	311	344	203	242
<b>8B10B 3.125</b>	355	297	311	289	321	278	165	192
<b>Scrambled 10.0</b>	251	66	Barely Open					
<b>Scrambled 10.3</b>	257	66	Barely Closed					
<b>8B10B 12.5</b>	175	42	Closed					

## Performance Measurement Setup - Optical

---

- Data Pattern
  - 1megabit in length using PRBS
- 8B10B Pattern
  - 8B10B Encode Data Pattern
- Scrambled Pattern
  - Scrambled Data Pattern based on proposed  $X^{58}+X^{19}+1$  Sequence

# Performance Measurement Setup - Optical

- ❑ Test setup used in Optical performance measurements

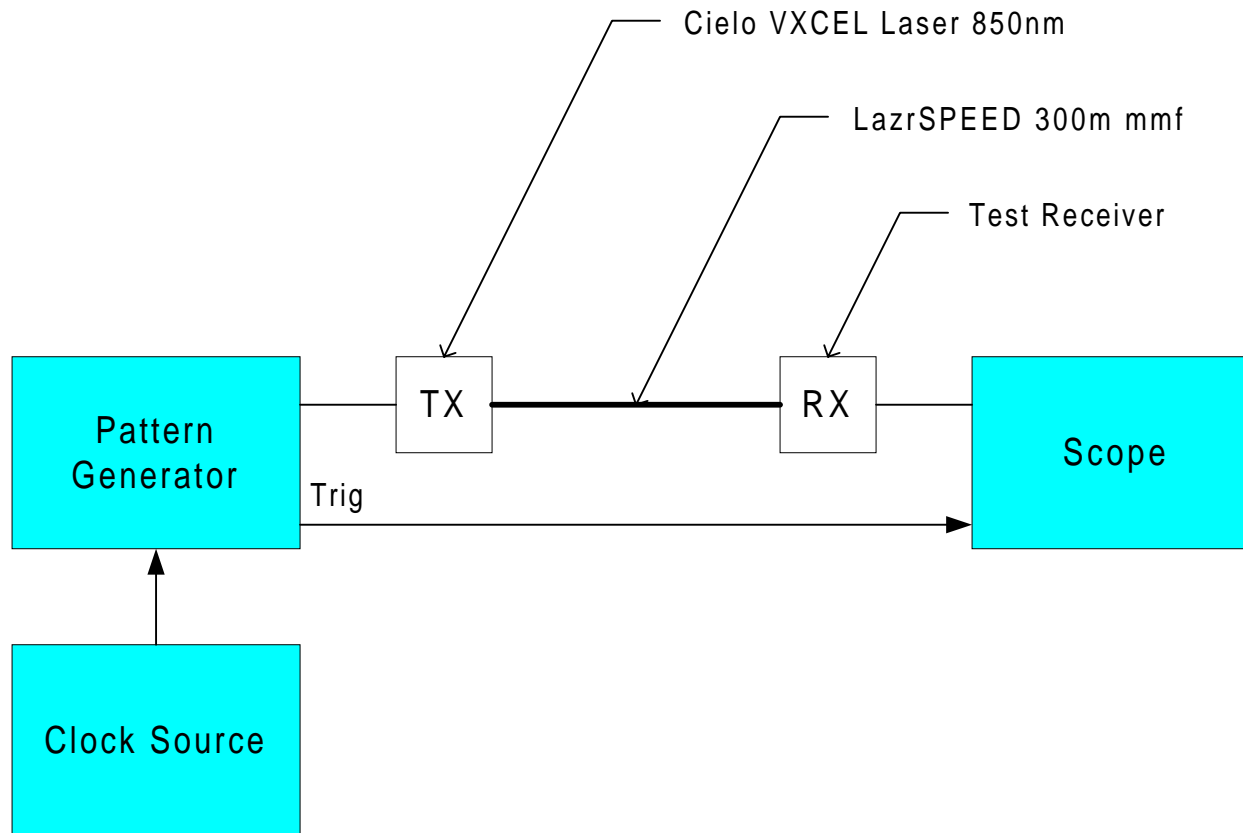

# Optical Data Eye Patterns

- ❑ Scrambled 10.0gigabit data with fiber length 1m.

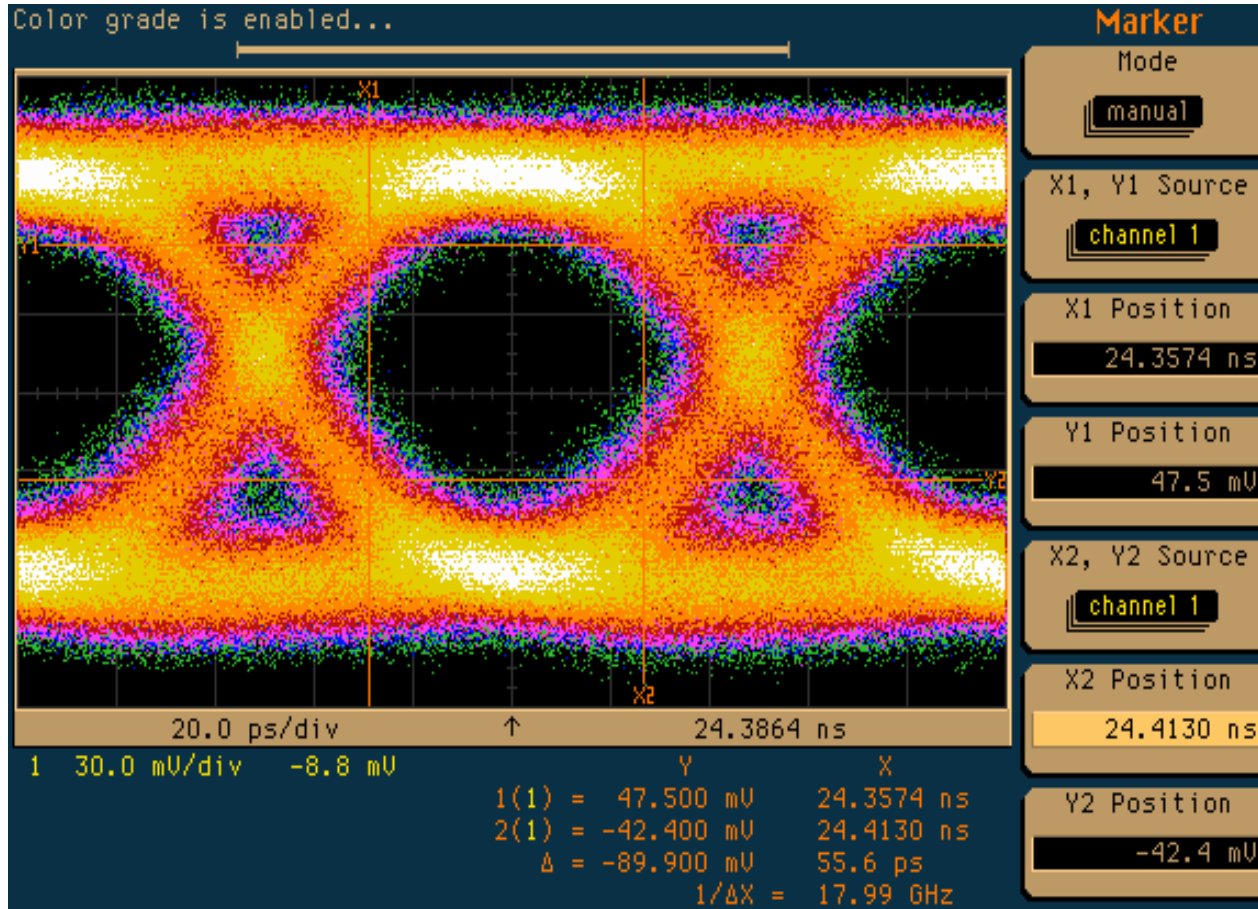

# Optical Data Eye Patterns

- ❑ 8B10B 12.5gigabit data with fiber length 1m.

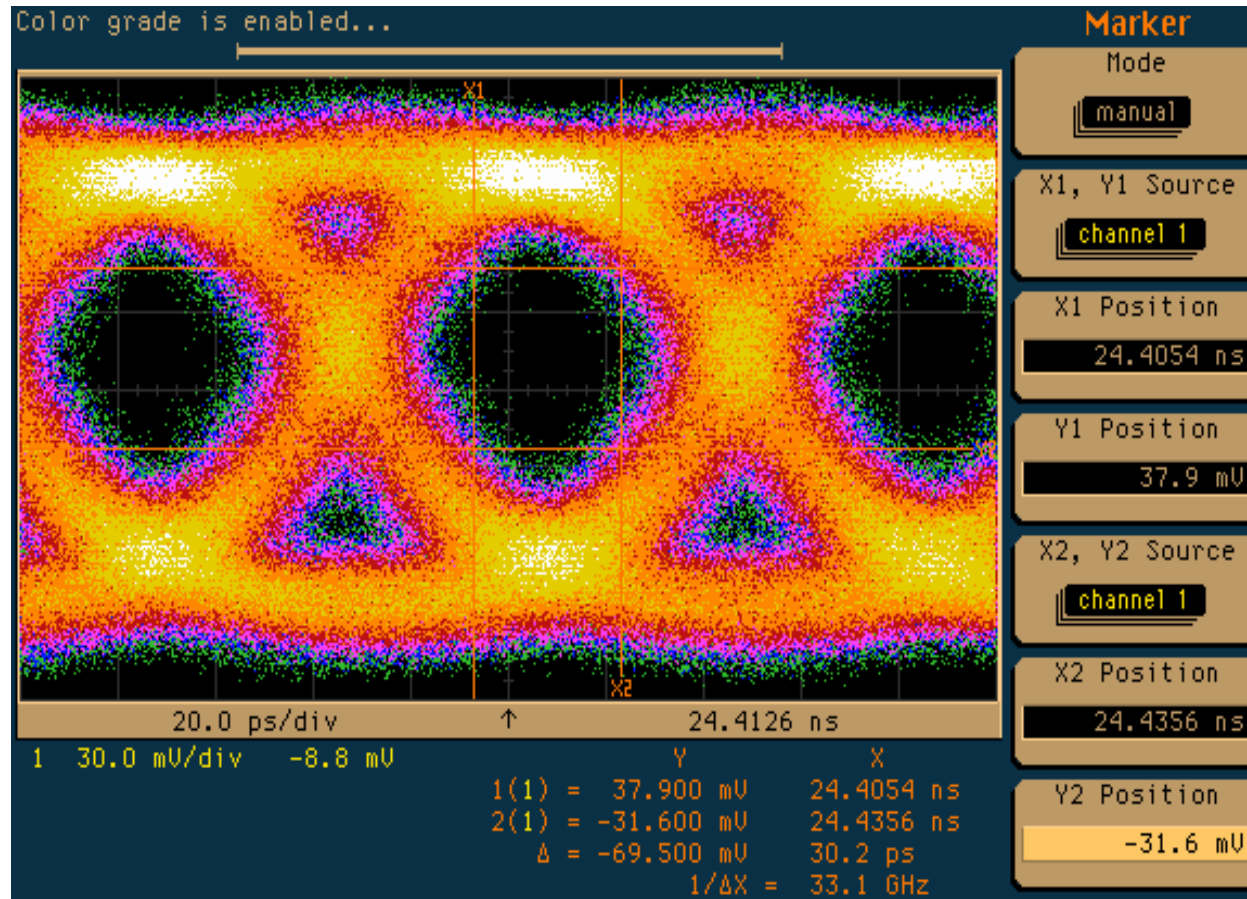

# Optical Data Eye Patterns

- ❑ Scrambled 10.0gigabit data with fiber length 300m.

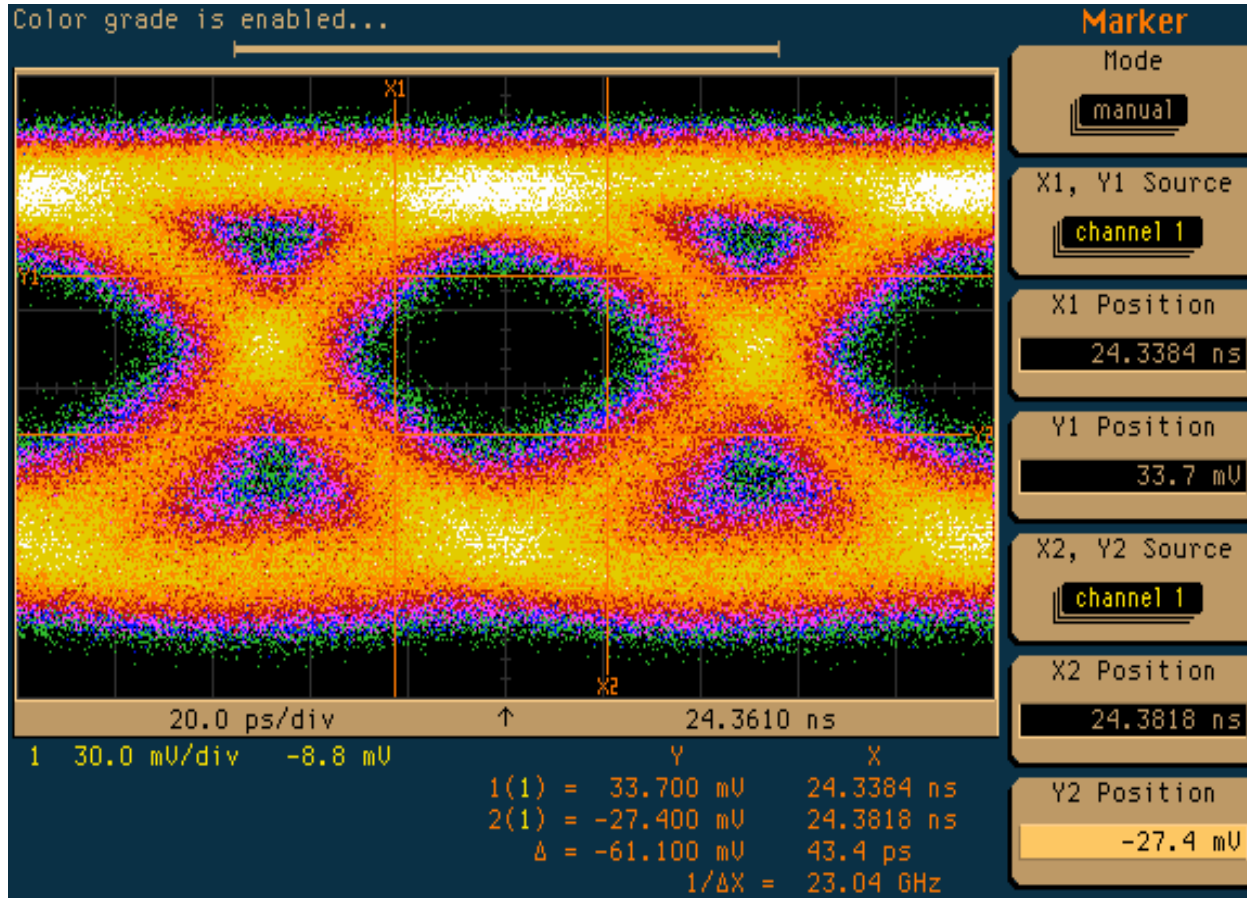



# Optical Data Eye Patterns

- ❑ 8B10B 12.5gigabit data with fiber length 300m.

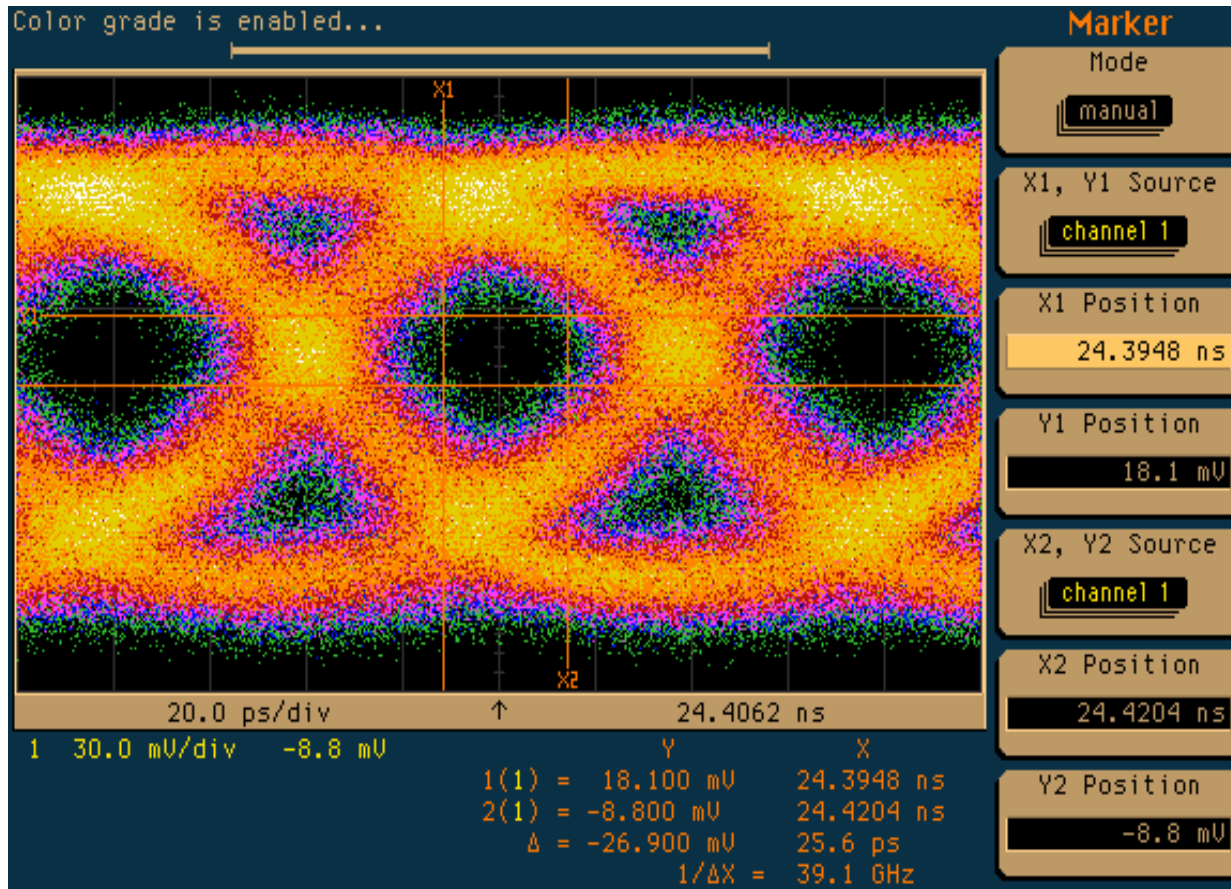

# Optical Data Summary

---

	Equipment		300m mmf	
	Amp in mv	Width in ps	Amp in mv	Width in ps
<b>Scrambled 10.3</b>	90	56	61	43
<b>8B10B 12.5</b>	70	30	27	26





# IDLE Pattern Spectral Measurements

---

- Data Pattern
  - 1megabit in length using PRBS
- 8B10B Pattern
  - 8B10B Encode Data Pattern
- Scrambled Pattern
  - Scrambled Data Pattern based on proposed  $X^{58}+X^{19}+1$  Sequence

# IDLE Pattern Spectral Measurements

---

- ❑ Test setup used in spectral measurements

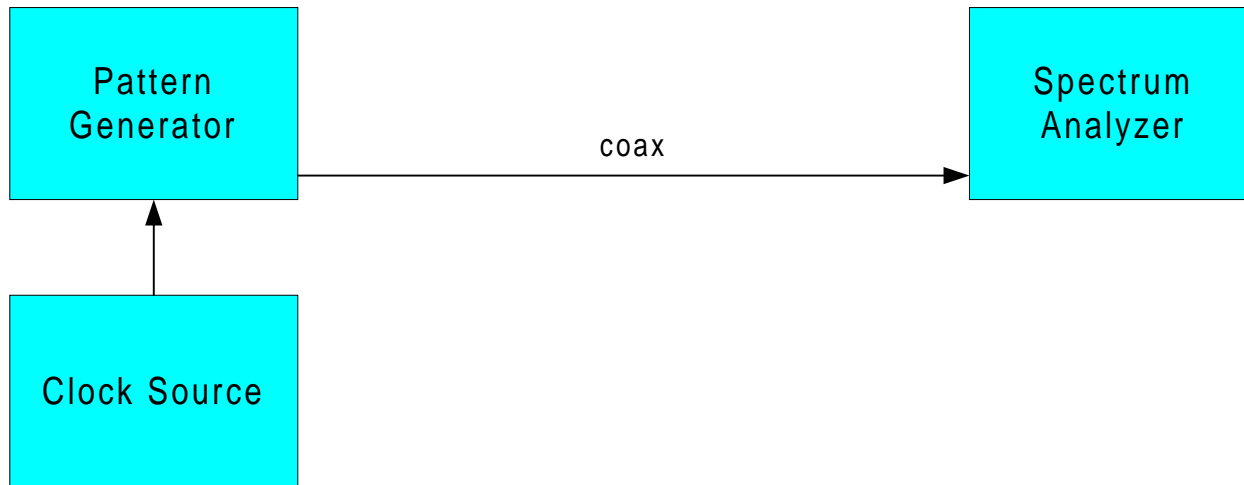

# IDLE Pattern Spectral Measurements

- ❑ Green: PRBS 2<sup>7</sup>-1 2.5gbit/sec
- ❑ Red: 8B10B 3.125gbit/sec

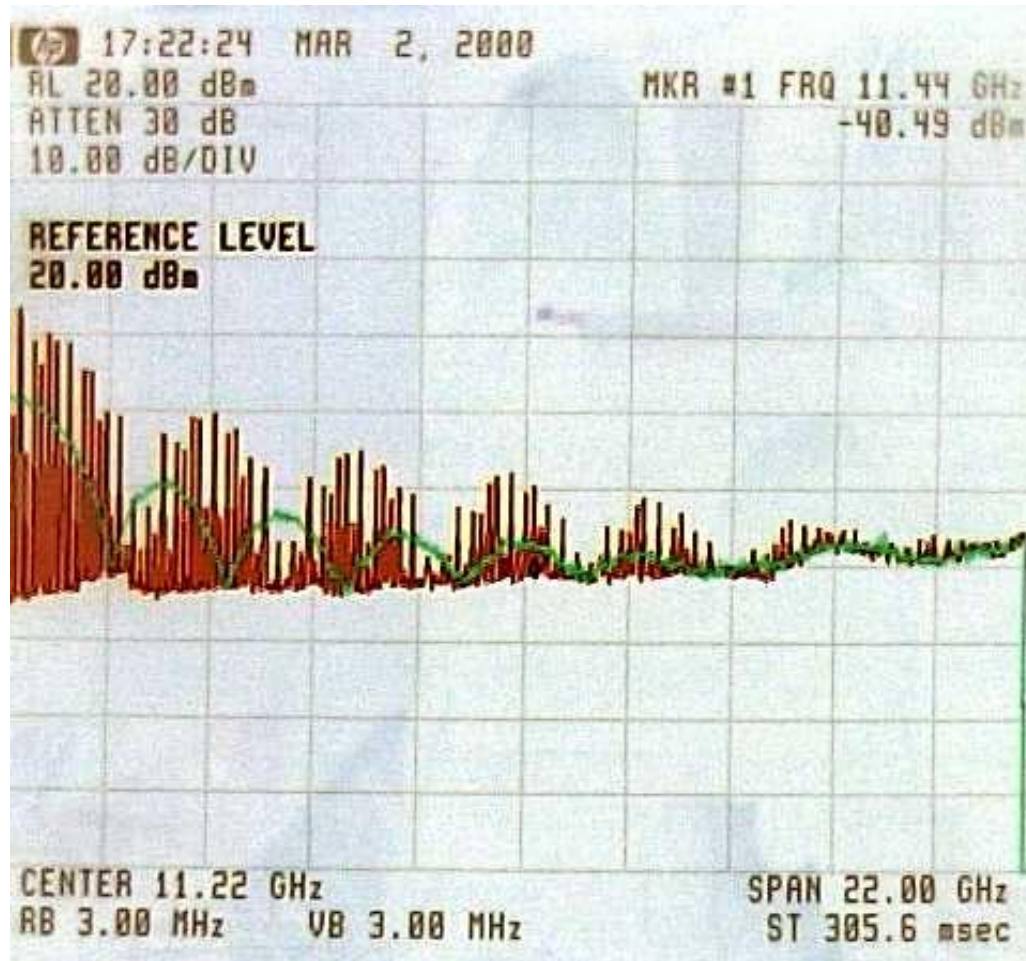

# IDLE Pattern Spectral Measurements

- ❑ Green: PRBS 2<sup>7</sup>-1 10gbit/sec
- ❑ Red: 8B10B 12.5gbit/sec

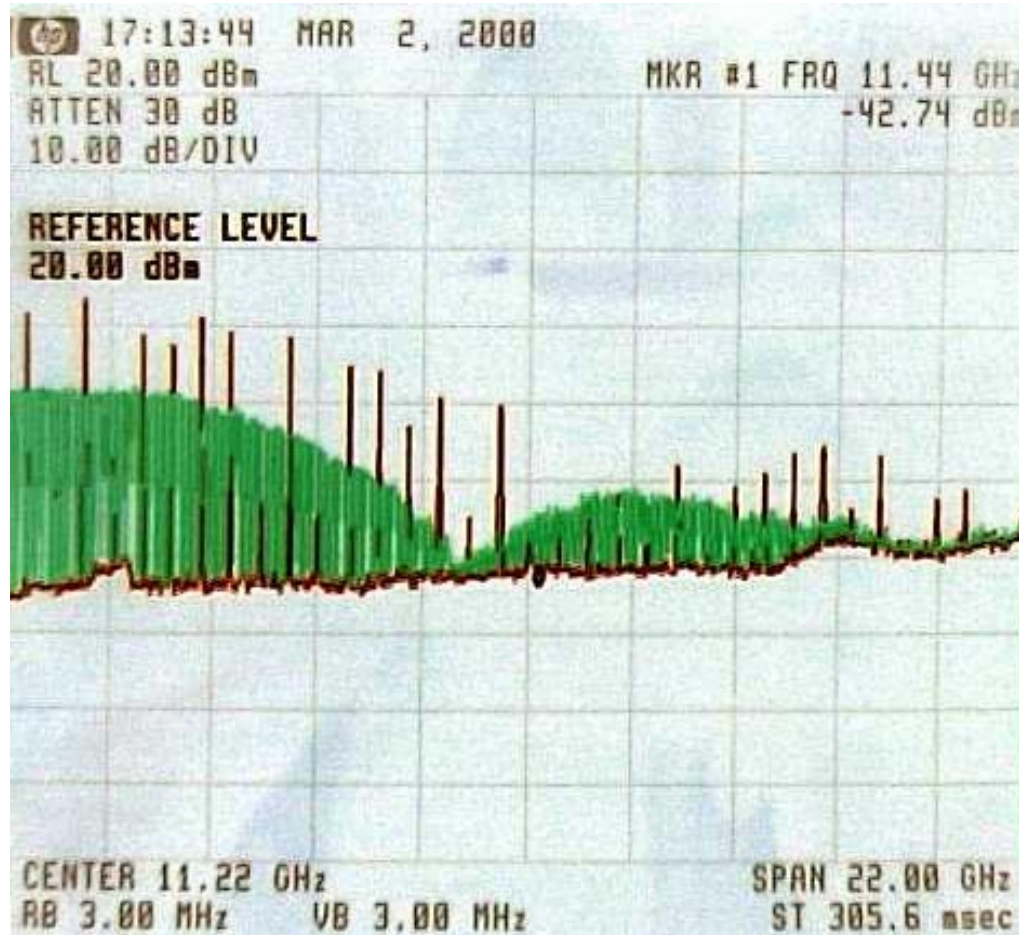

## Data Summary

---

- ❑ 10gigabit Scrambled data offers a 57% greater differential horizontal opening / 65% greater optical horizontal opening over 12.5gigabit 8B10B encoding.
- ❑ Effects of DC wander are difficult to observe.
- ❑ Scrambled data offers EMI advantages over 8B10B encoding.