

**IEEE P802.3an Task Force  
(10GBASE-T)  
Agenda and General Information**

**Chandler, AZ  
January 10-12, 2006**

**Brad Booth, Task Force Chair**

---

# Please Put Cell Phones on Stun!!



# Agenda

- **Welcome**
- **Recording Secretary:**
- **Introductions**
- **Approval of the Minutes**
- **Plans for the Week**
- **Reflector and Web**
- **Ground Rules**
- **IEEE**
  - **Structure**
  - **Bylaws and Rules**
  - **Call for Patents**
  - **IEEE Standards Process**
- **Future Meetings**
- **Reports**
- **Comment Resolution & Presentations**
- **Summary**

# 10GBASE-T Crew

- **Chair**
  - Brad Booth
- **Editor-in-chief**
  - Sanjay Kasturia
- **Editors:**
  - Eric Lynskey: Auto-negotiation (Clause 28, 55.6)
  - Mike McConnell: MDIO (Clause 45)
  - Jose Tellado: PCS
  - Sandeep Gupta: PMA
  - Terry Cobb: MDI (55.8)
  - Chris Diminico: Channel (55.7)

# Plans for the Week

- **COMMENTS, COMMENTS, COMMENTS**
  - Respond to all comments submitted on D3.0
- **Recirculation**
  - Generation of D3.1
  - Recirculation of D3.1

# Reflector and Web

- To subscribe to any of the 10GBASE-T reflectors send an email to:

*listserv@ieee.org*

with the following in the body of the message:

*subscribe stds-802-3-10GBT <your name>  
end*

for example:

*subscribe stds-802-3-10GBT Brad Booth  
end*

- P802.3an Task Force web page URL:  
*<http://www.ieee802.org/3/an/>*

# P802.3an Documents

- **Draft**
  - [www.ieee802.org/3/an/private/](http://www.ieee802.org/3/an/private/)
  - **Access**
    - Userid: 802.3an
    - Password: \*\*\*\*\*
  - Write it down!!
- **PAR (Project Authorization Request)**
  - [www.ieee802.org/3/an/par.pdf](http://www.ieee802.org/3/an/par.pdf)
- **5 Criteria**
  - [www.ieee802.org/3/an/5Criteria.pdf](http://www.ieee802.org/3/an/5Criteria.pdf)
- **Objectives**
  - [www.ieee802.org/3/an/objectives.pdf](http://www.ieee802.org/3/an/objectives.pdf)

# Ground Rules

- **802.3 Rules apply**
  - Foundation based upon Robert's Rules of Order
- **Anyone in the room may speak**
- **Anyone in the room may vote**
- **RESPECT... give it, get it**
- **NO product pitches**
- **NO corporate pitches**
- **NO prices!!!**
  - This includes costs, ASPs, etc. no matter what the currency
- **NO restrictive notices**



# **IEEE-SA Standards Board Bylaws on Patents in Standards**

## 6. Patents

IEEE standards may include the known use of essential patents and patent applications provided the IEEE receives assurance from the patent holder or applicant with respect to patents whose infringement is, or in the case of patent applications, potential future infringement the applicant asserts will be, unavoidable in a compliant implementation of either mandatory or optional portions of the standard [essential patents]. This assurance shall be provided without coercion and prior to approval of the standard (or reaffirmation when a patent or patent application becomes known after initial approval of the standard). This assurance shall be a letter that is in the form of either:

a) A general disclaimer to the effect that the patentee will not enforce any of its present or future patent(s) whose use would be required to implement either mandatory or optional portions of the proposed IEEE standard against any person or entity complying with the standard; or

b) A statement that a license for such implementation will be made available without compensation or under reasonable rates, with reasonable terms and conditions that are demonstrably free of any unfair discrimination.

This assurance shall apply, at a minimum, from the date of the standard's approval to the date of the standard's withdrawal and is irrevocable during that period.

Approved by IEEE-SA Standards Board – March 2003 (Revised March 2005)

# Inappropriate Topics for IEEE WG Meetings

- **Don't discuss the validity/essentiality of patents/patent claims**
- **Don't discuss the cost of specific patent use**
- **Don't discuss licensing terms or conditions**
- **Don't discuss product pricing, territorial restrictions, or market share**
- **Don't discuss ongoing litigation or threatened litigation**
- **Don't be silent if inappropriate topics are discussed... do formally object.**

If you have questions, contact the IEEE-SA Standards Board Patent Committee Administrator at [patcom@ieee.org](mailto:patcom@ieee.org) or visit <http://standards.ieee.org/board/pat/index.html>

This slide set is available at  
<http://standards.ieee.org/board/pat/pat-slideset.ppt>

Approved by IEEE-SA Standards Board – March 2003 (Revised March 2005)

# IEEE Structure

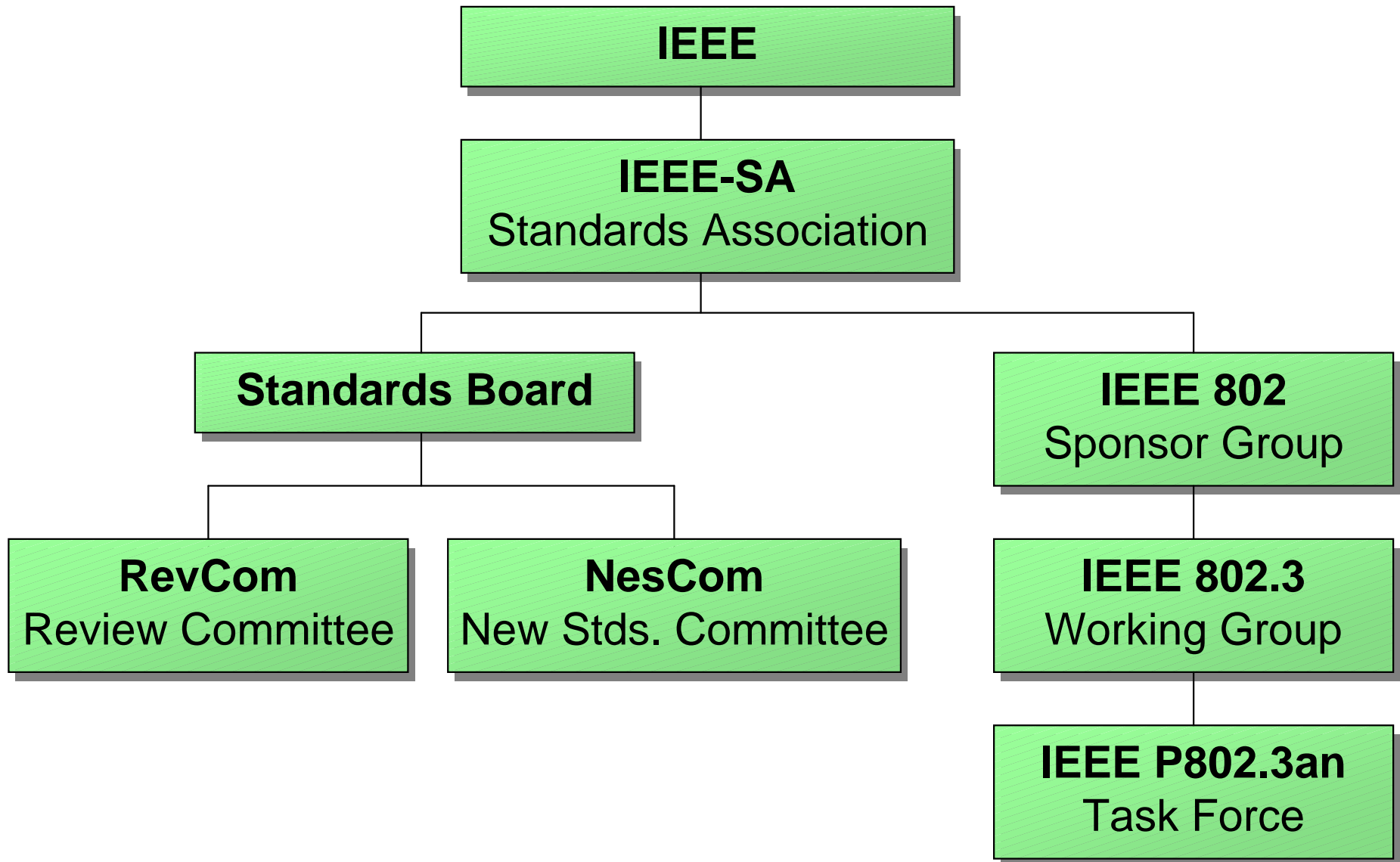

# Bylaws and Rules

- **Bylaws of the IEEE Standards Association (IEEE-SA):**

*<http://standards.ieee.org/sa/sa-bylaws.pdf>*

- **Bylaws of the IEEE-SA Standards Board:**

*<http://standards.ieee.org/guides/bylaws/sb-bylaws.pdf>*

- **IEEE LAN/MAN Standards Committee (LMSC) Operating Rules:**

*<http://www.ieee802.org/rules.pdf>*

- **IEEE 802.3 Working Group Operating Rules:**

*<http://www.ieee802.org/3/rules/>*

# IEEE Standards Process

## Study Group Formation

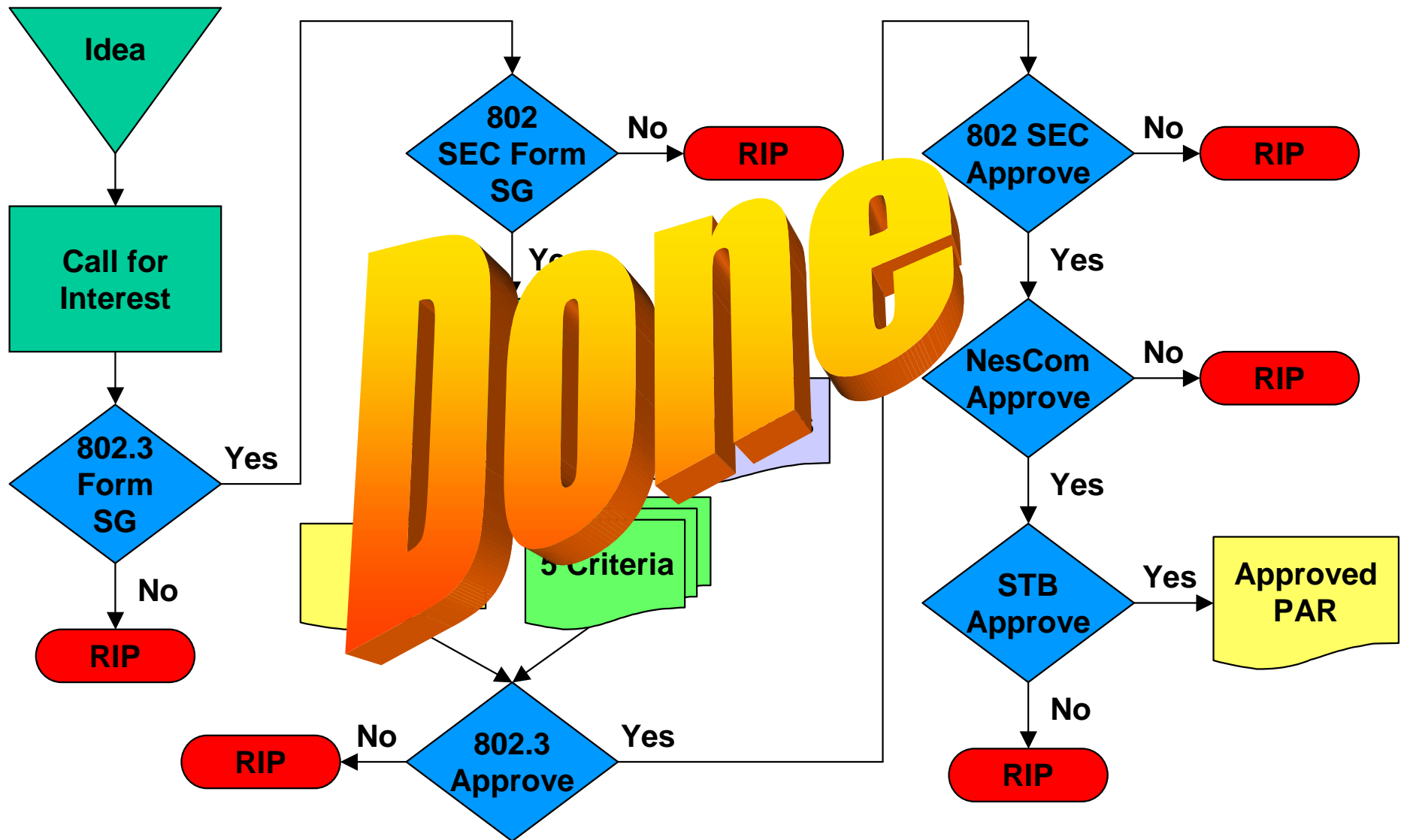

# IEEE Standards Process

## Task Force Review

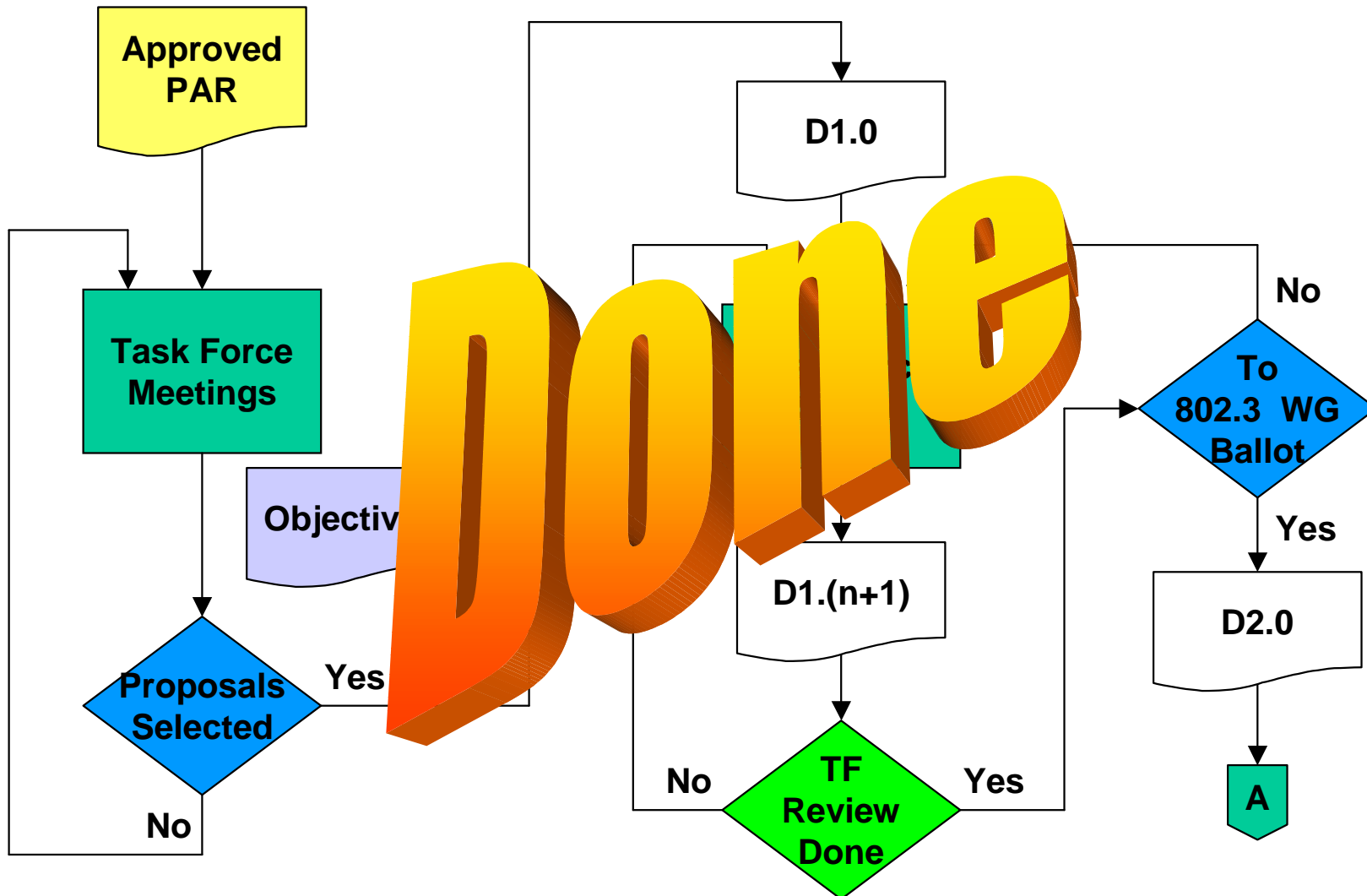

# IEEE Standards Process

## Working Group Ballot

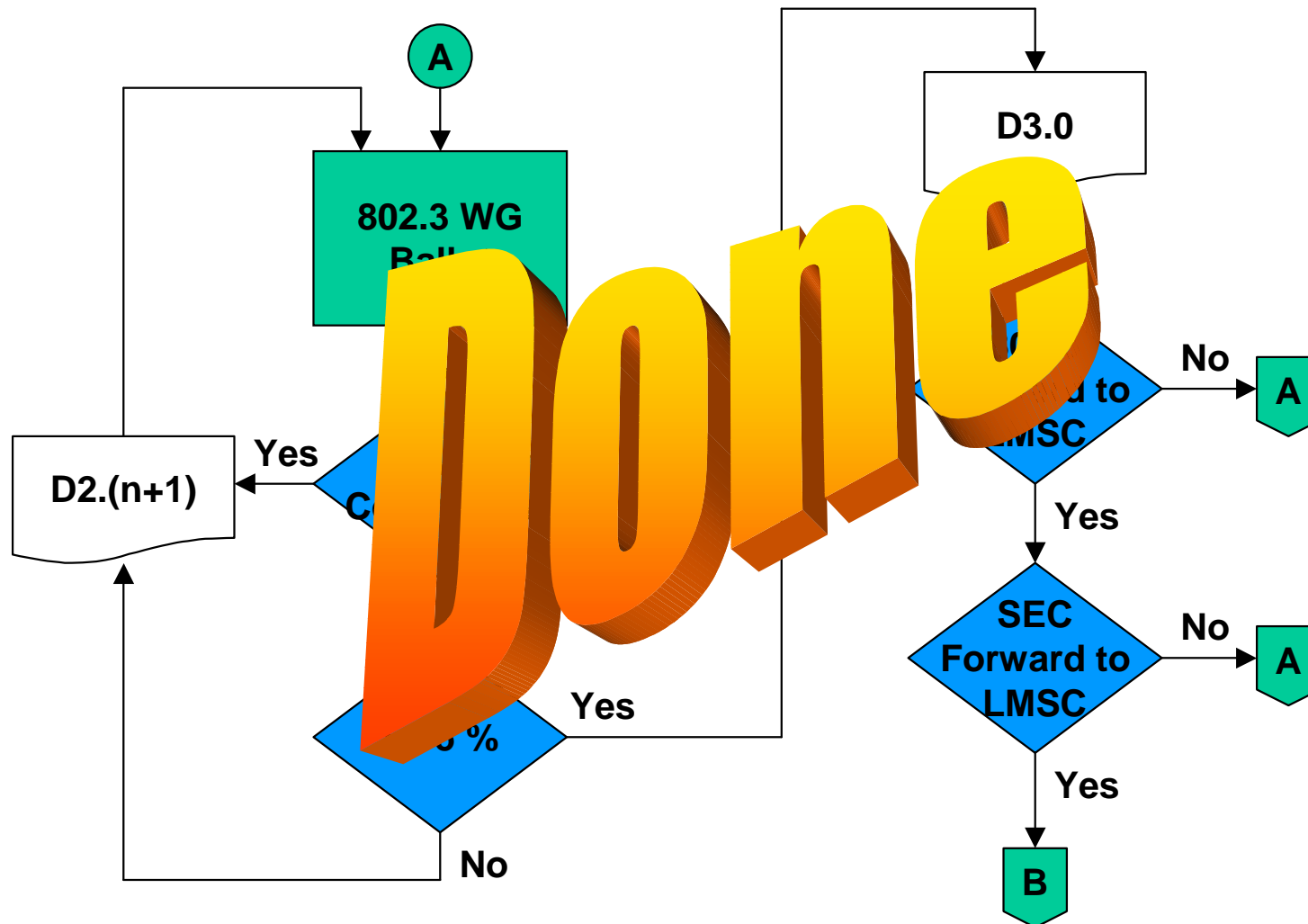

# IEEE Standards Process

## Sponsor Ballot

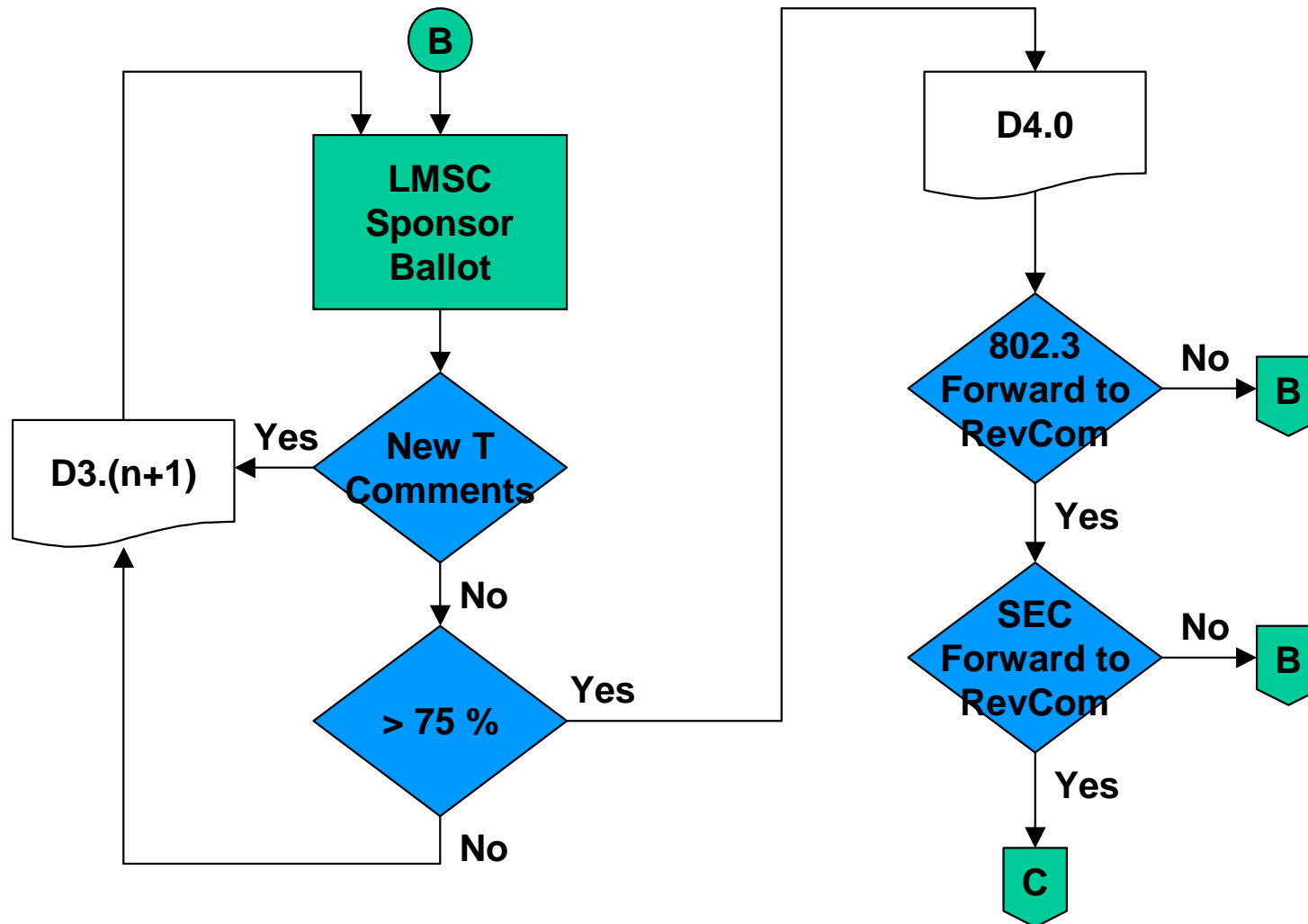



# IEEE Standards Process

## Standard Approval

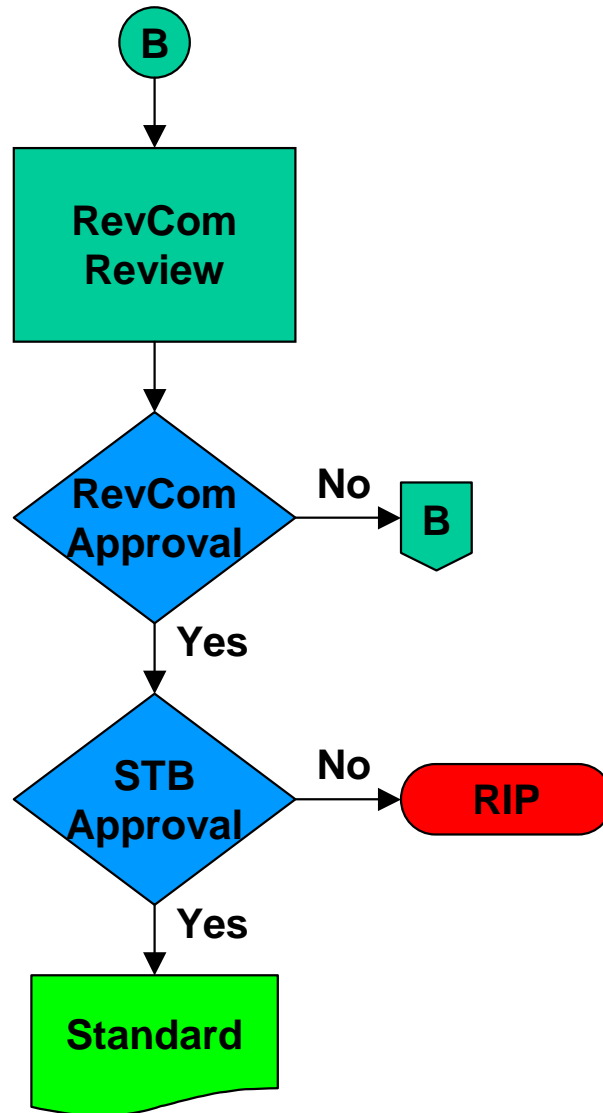

# P802.3an Timeline

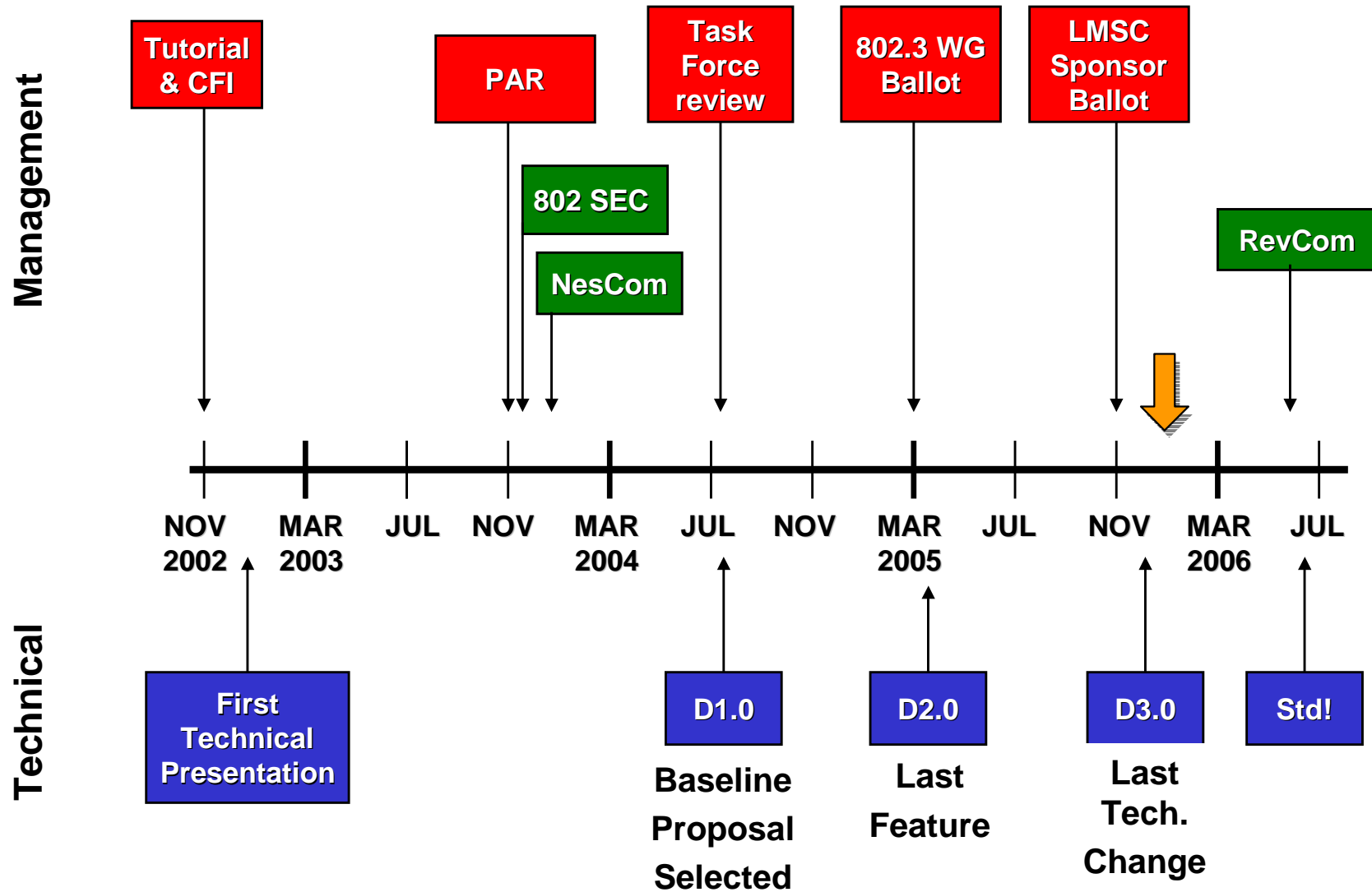

# P802.3an Timeline Magnified

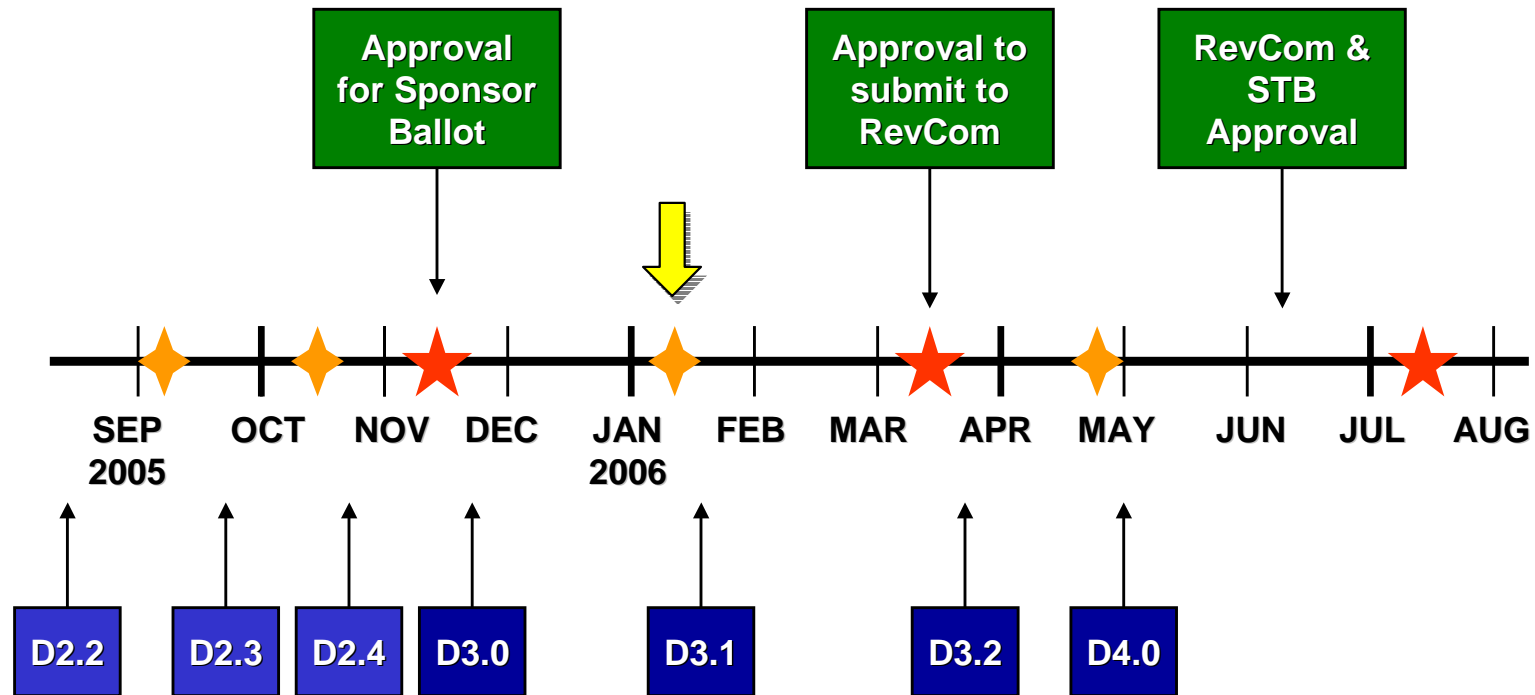

◆ Interim Meeting    ★ Plenary Meeting

# Future Meetings

- **March 2006 Plenary:**
  - **Date: Week of the 6th**
  - **Location: Denver, CO**
  - **Hotel: Hyatt Regency @ Colorado Convention Center**
- **April 2006 Interim:**
  - **Host still needed**
  - **Target date: late April**
- **July 2006 Plenary:**
  - **Date: Week of the 16<sup>th</sup>**
  - **Location: San Diego, CA**
  - **Hotel: Grand Hyatt Manchester**

# Reports

- **ISO/IEC**
  - No update
- **TIA**
  - Report on December meeting
- **Editor's report**
  - How did we do on D3.0?

# Comment Resolution & Presentations

# Motions & Straw Polls

**Thank You!**