

**IEEE P802.3an Task Force
(10GBASE-T)
Agenda and General Information**

**Denver, CO
March 7-8, 2006**

Brad Booth, Task Force Chair

Please Put Cell Phones on Stun!!



Agenda

- **Welcome**
- **Recording Secretary:**
- **Introductions**
- **Approval of the Minutes**
- **Plans for the Week**
- **Reflector and Web**
- **Ground Rules**
- **IEEE**
 - **Structure**
 - **Bylaws and Rules**
 - **Call for Patents**
 - **IEEE Standards Process**
- **Future Meetings**
- **Reports**
- **Comment Resolution & Presentations**
- **Summary**

10GBASE-T Crew

- **Chair**
 - Brad Booth
- **Editor-in-chief**
 - Sanjay Kasturia
- **Editors:**
 - Eric Lynskey: Auto-negotiation (Clause 28, 55.6)
 - Mike McConnell: MDIO (Clause 45)
 - Jose Tellado: PCS
 - Sandeep Gupta: PMA
 - Terry Cobb: MDI (55.8)
 - Chris Diminico: Channel (55.7)

Ballot Status

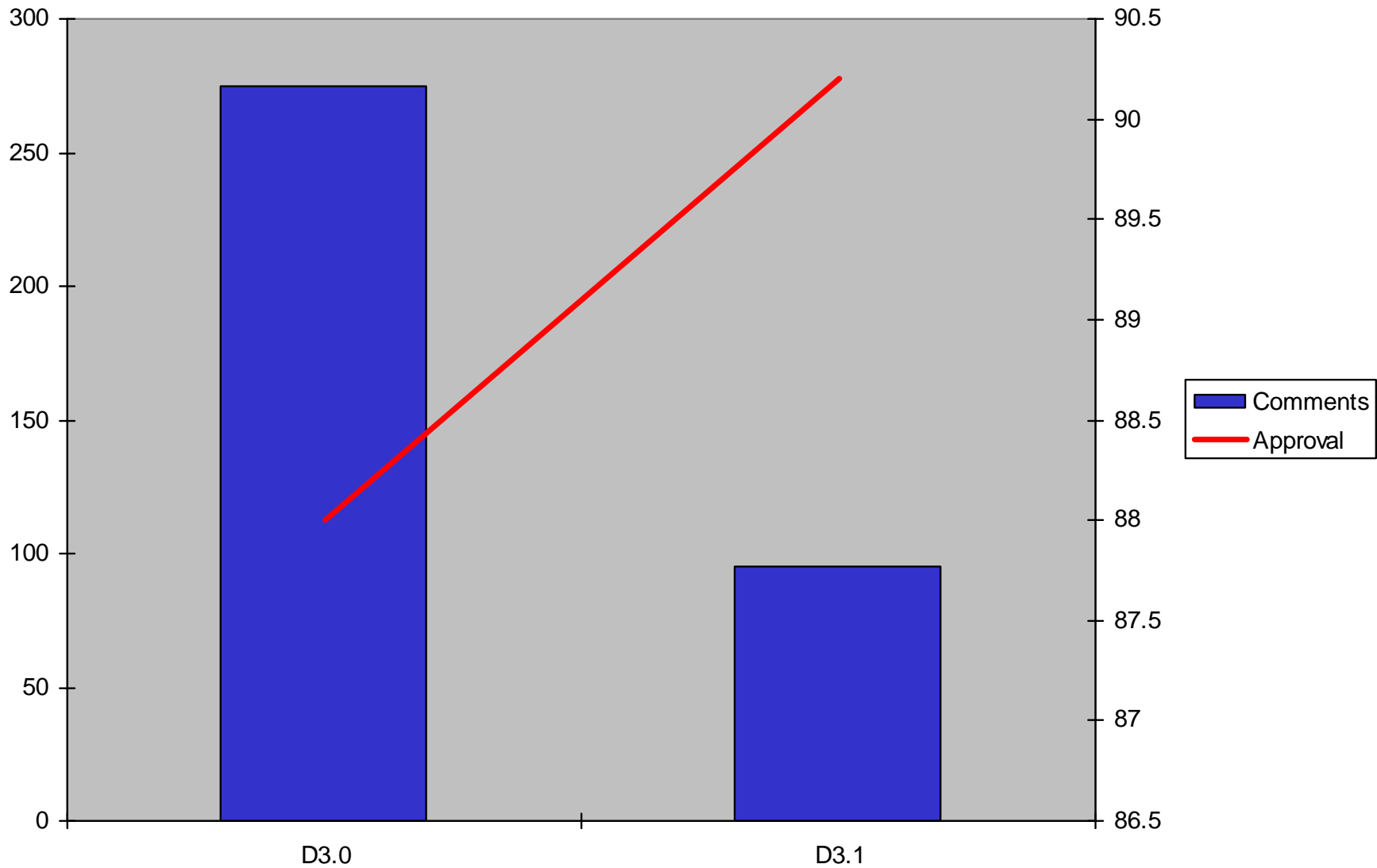

Plans for the Week

- **Review all 95 D3.1 comments**
- **Respond to any liaison letters**
 - **ISO/IEC liaison from their February meeting**
- **Request conditional approval for submission to RevCom**
 - **April interim will generate D4.0 for submission to RevCom**
 - **May interim will be go/no-go decision for leaving D4.0 on the RevCom agenda**

Reflector and Web

- To subscribe to any of the 10GBASE-T reflectors send an email to:

listserv@ieee.org

with the following in the body of the message:

*subscribe stds-802-3-10GBT <your name>
end*

for example:

*subscribe stds-802-3-10GBT Brad Booth
end*

- P802.3an Task Force web page URL:
<http://www.ieee802.org/3/an/>

P802.3an Documents

- **Draft**
 - www.ieee802.org/3/an/private/
 - **Access**
 - Userid: 802.3an
 - Password: *****
 - Write it down!!
- **PAR (Project Authorization Request)**
 - www.ieee802.org/3/an/par.pdf
- **5 Criteria**
 - www.ieee802.org/3/an/5Criteria.pdf
- **Objectives**
 - www.ieee802.org/3/an/objectives.pdf

Ground Rules

- **Based upon 802.3 rules**
 - Foundation based upon Robert's Rules of Order
- **Anyone in the room may speak**
- **Anyone in the room may vote**
- **RESPECT... give it, get it**
- **NO product pitches**
- **NO corporate pitches**
- **NO prices!!!**
 - This includes costs, ASPs, etc. no matter what the currency
- **NO restrictive notices**

IEEE-SA Standards Board Bylaws on Patents in Standards

6. Patents

IEEE standards may include the known use of essential patents and patent applications provided the IEEE receives assurance from the patent holder or applicant with respect to patents whose infringement is, or in the case of patent applications, potential future infringement the applicant asserts will be, unavoidable in a compliant implementation of either mandatory or optional portions of the standard [essential patents]. This assurance shall be provided without coercion. The patent holder or applicant should provide this assurance as soon as reasonably feasible in the standards development process. This assurance shall be provided no later than the approval of the standard (or reaffirmation when a patent or patent application becomes known after initial approval of the standard). This assurance shall be either:

- a) A general disclaimer to the effect that the patentee will not enforce any of its present or future patent(s) whose use would be required to implement either mandatory or optional portions of the proposed IEEE standard against any person or entity complying with the standard; or
- b) A statement that a license for such implementation will be made available without compensation or under reasonable rates, with reasonable terms and conditions that are demonstrably free of any unfair discrimination.

This assurance is irrevocable once submitted and accepted and shall apply, at a minimum, from the date of the standard's approval to the date of the standard's withdrawal.

Approved by IEEE-SA Standards Board – March 2003 (Revised February 2006)

Inappropriate Topics for IEEE WG Meetings

- **Don't discuss the validity/essentiality of patents/patent claims**
- **Don't discuss the cost of specific patent use**
- **Don't discuss licensing terms or conditions**
- **Don't discuss product pricing, territorial restrictions, or market share**
- **Don't discuss ongoing litigation or threatened litigation**
- **Don't be silent if inappropriate topics are discussed... do formally object.**

If you have questions, contact the IEEE-SA Standards Board Patent Committee Administrator at patcom@ieee.org or visit <http://standards.ieee.org/board/pat/index.html>

This slide set is available at
<http://standards.ieee.org/board/pat/pat-slideset.ppt>

Approved by IEEE-SA Standards Board – March 2003 (Revised February 2006)

IEEE Structure

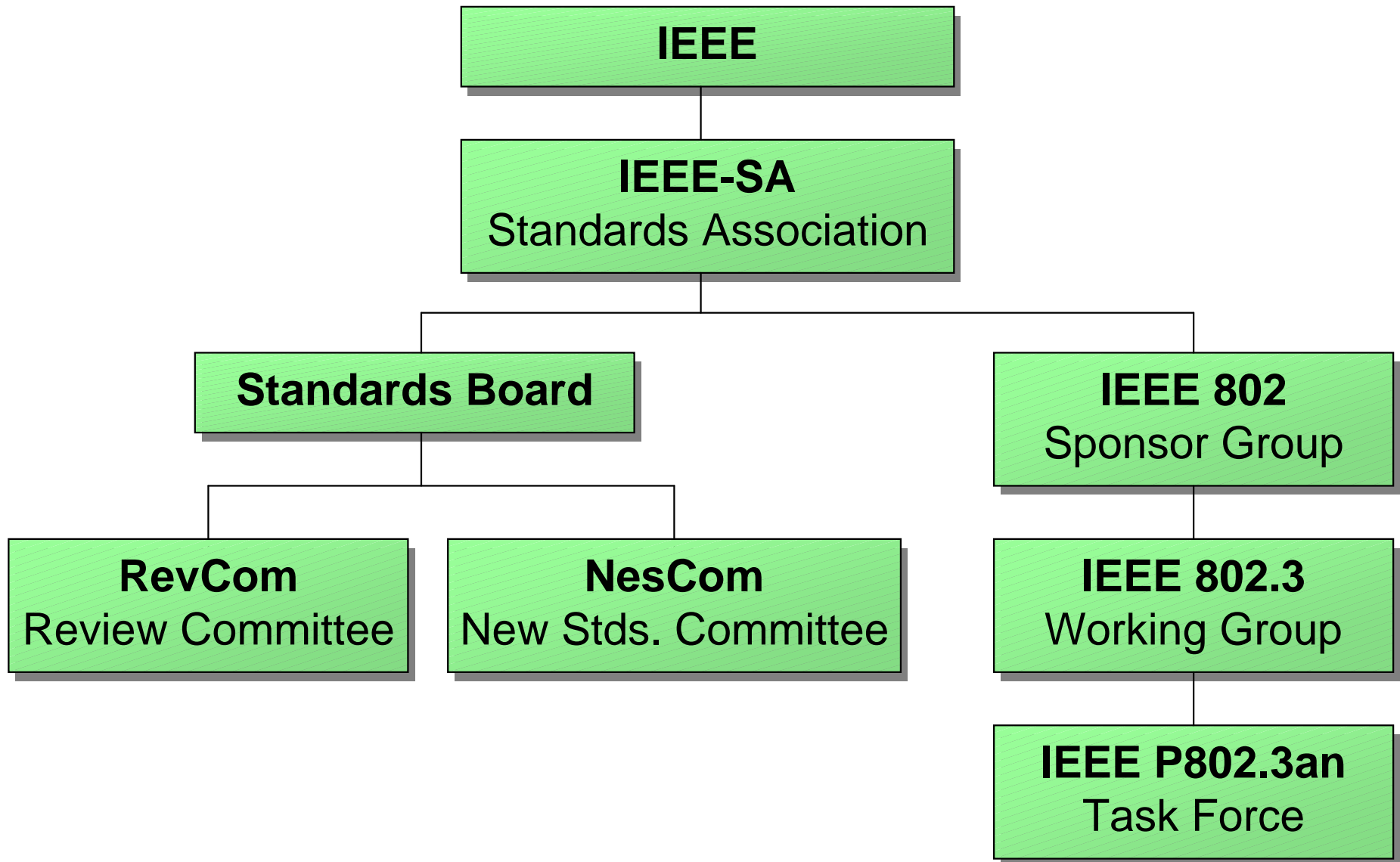

Bylaws and Rules

- **Bylaws of the IEEE Standards Association (IEEE-SA):**

<http://standards.ieee.org/sa/sa-bylaws.pdf>

- **Bylaws of the IEEE-SA Standards Board:**

<http://standards.ieee.org/guides/bylaws/sb-bylaws.pdf>

- **IEEE LAN/MAN Standards Committee (LMSC) Operating Rules:**

<http://www.ieee802.org/rules.pdf>

- **IEEE 802.3 Working Group Operating Rules:**

<http://www.ieee802.org/3/rules/>

IEEE Standards Process

Study Group Formation

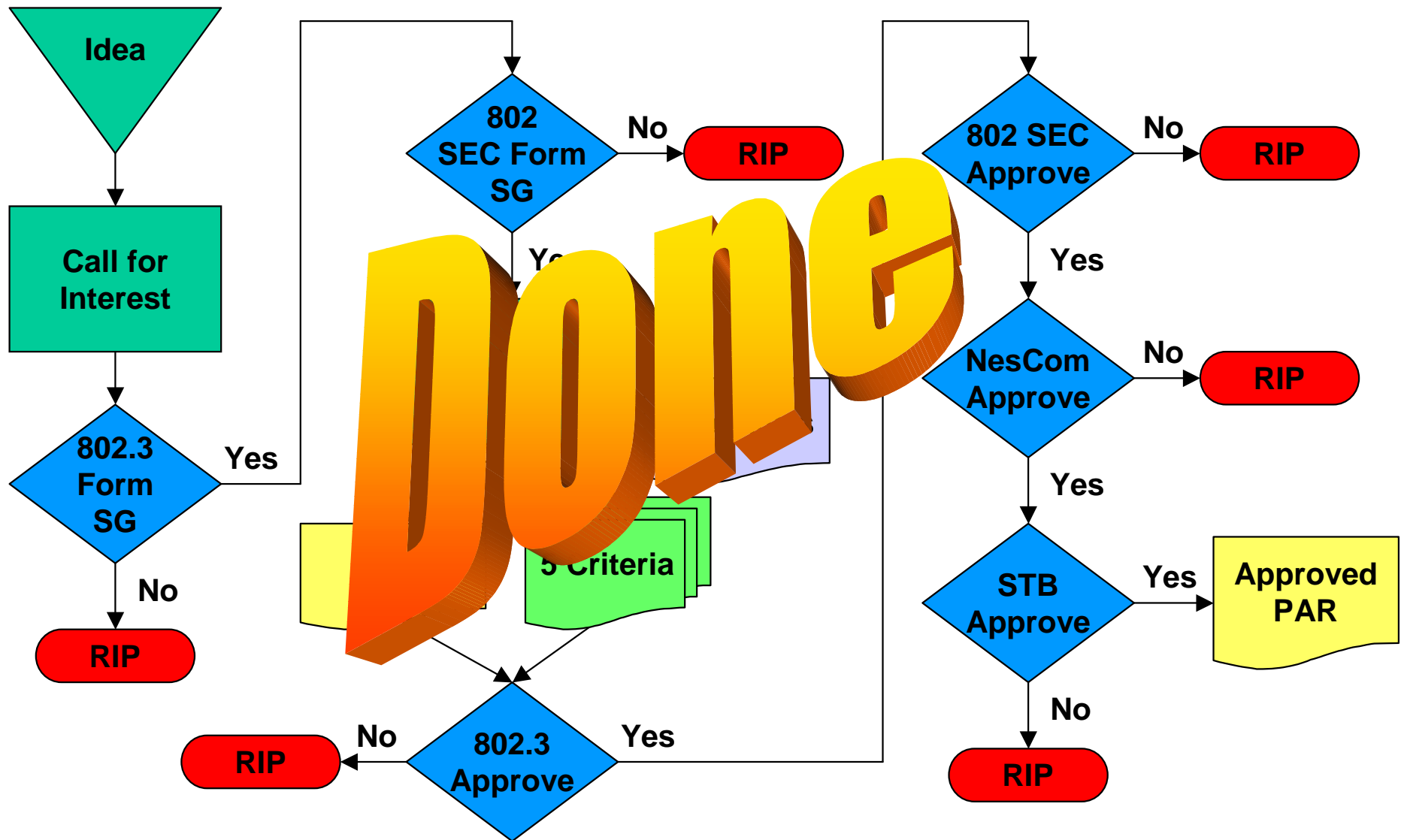

IEEE Standards Process

Task Force Review

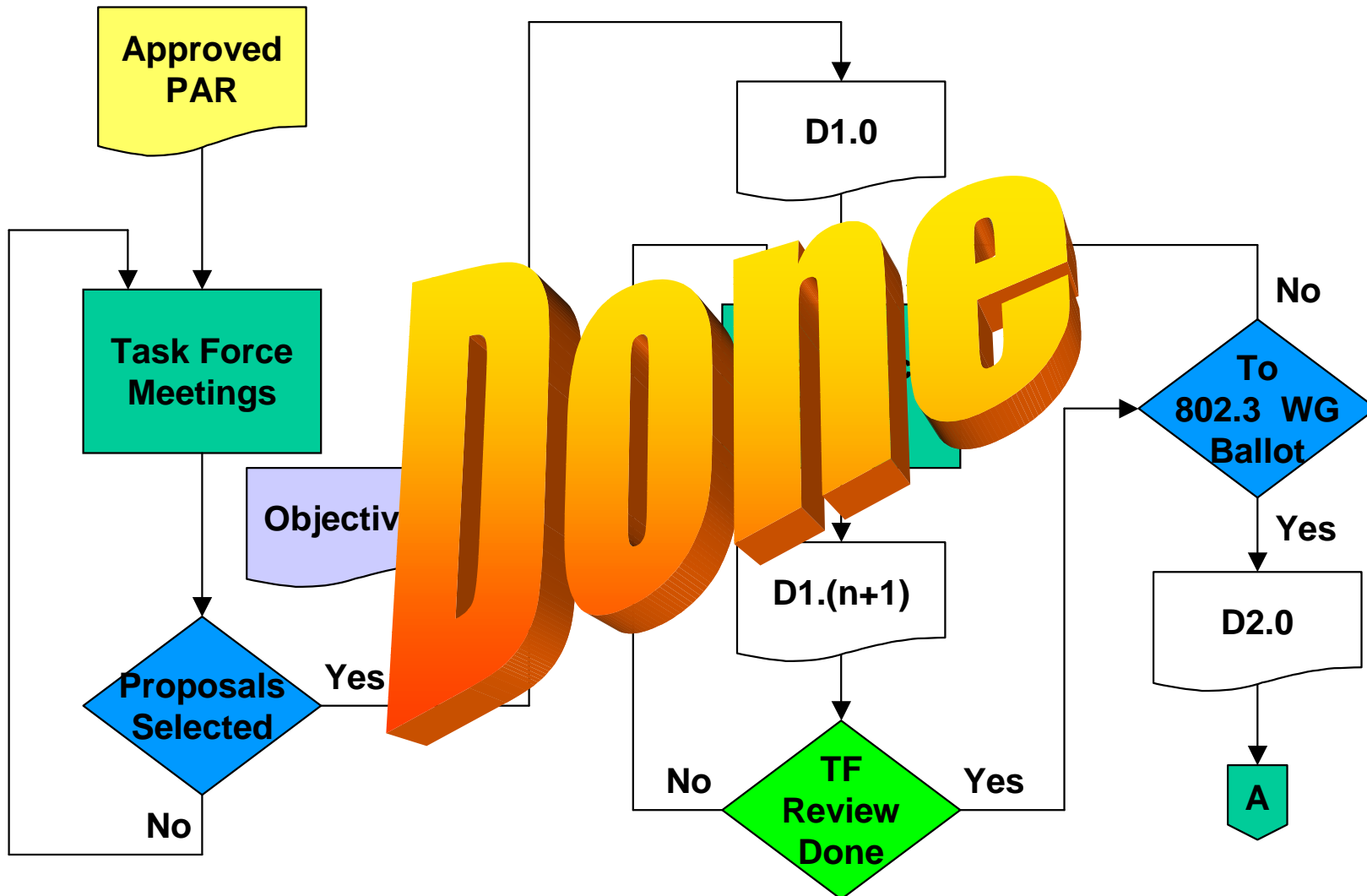

IEEE Standards Process

Working Group Ballot

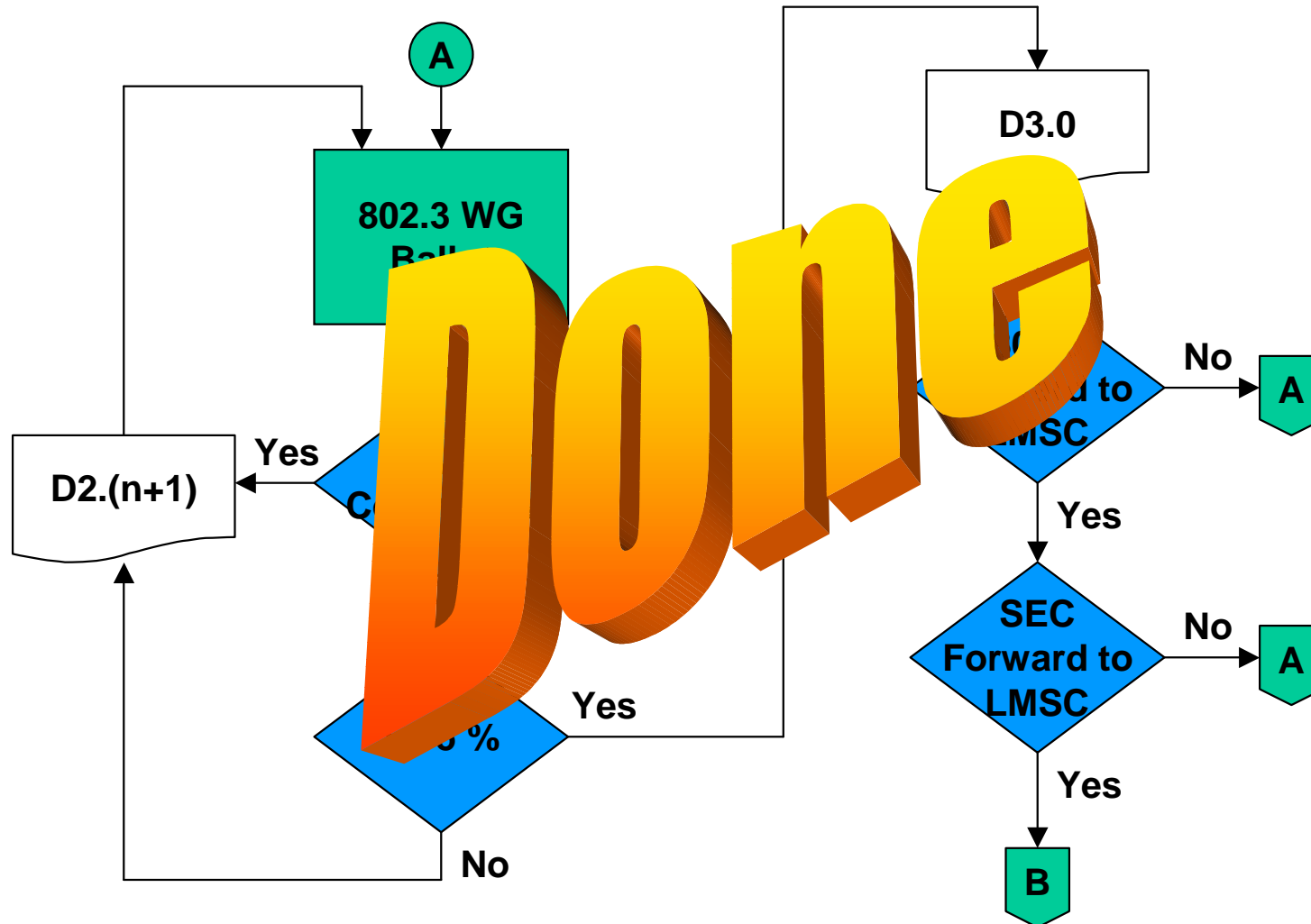

IEEE Standards Process

Sponsor Ballot

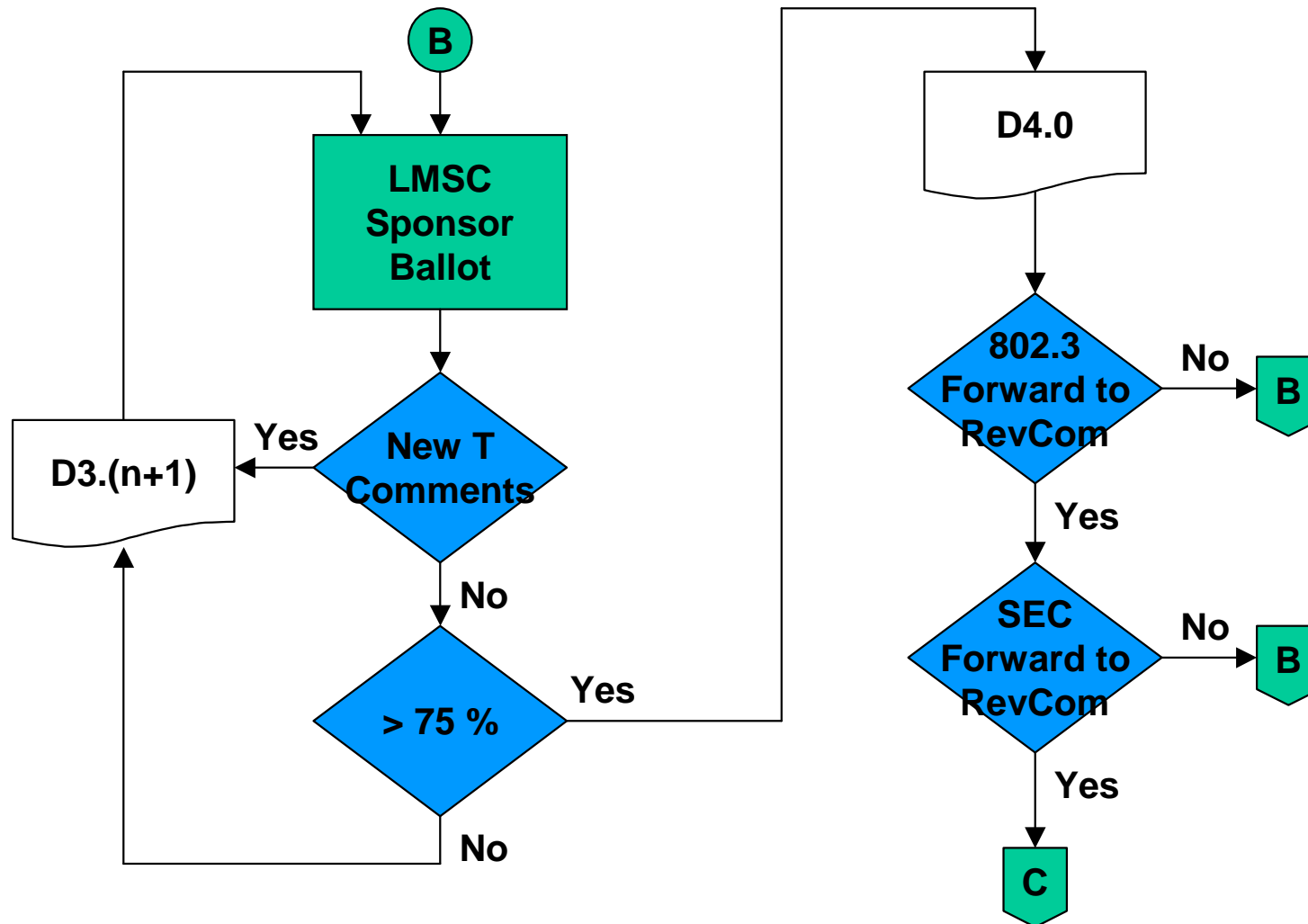

IEEE Standards Process

Standard Approval

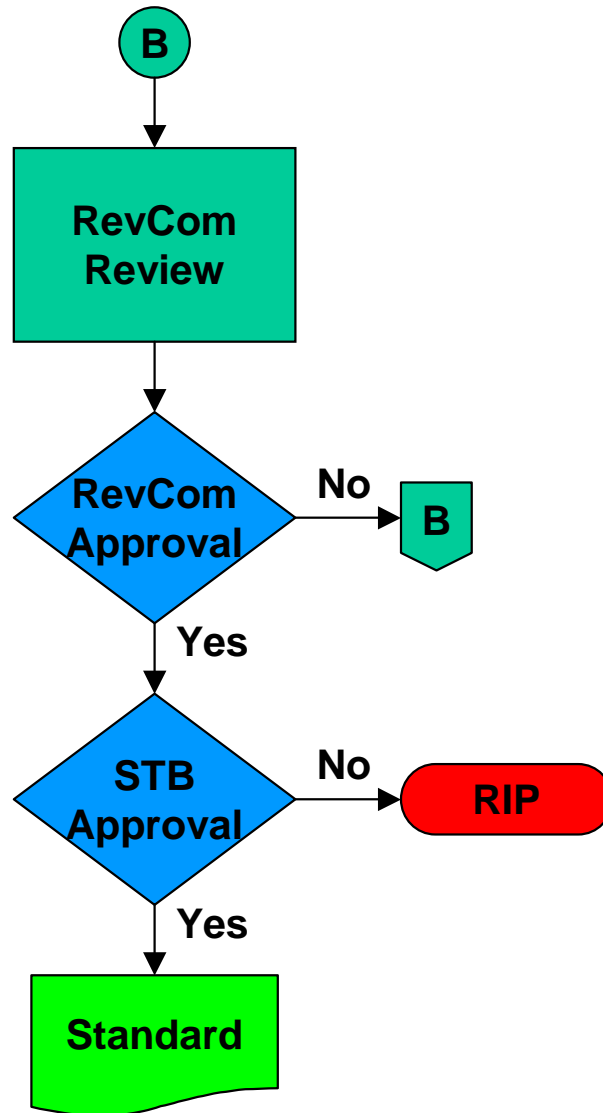

P802.3an Timeline

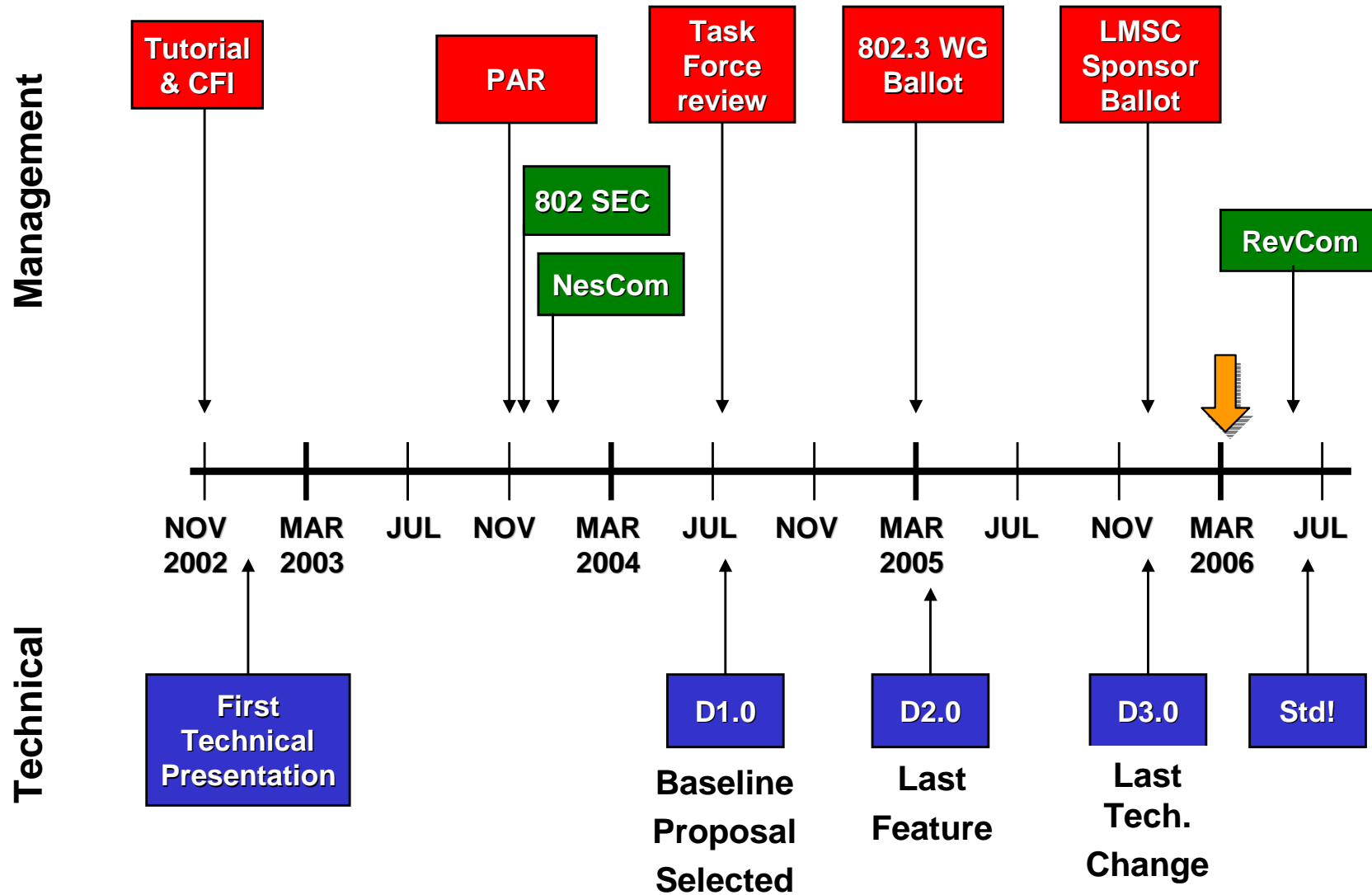

P802.3an Timeline Magnified

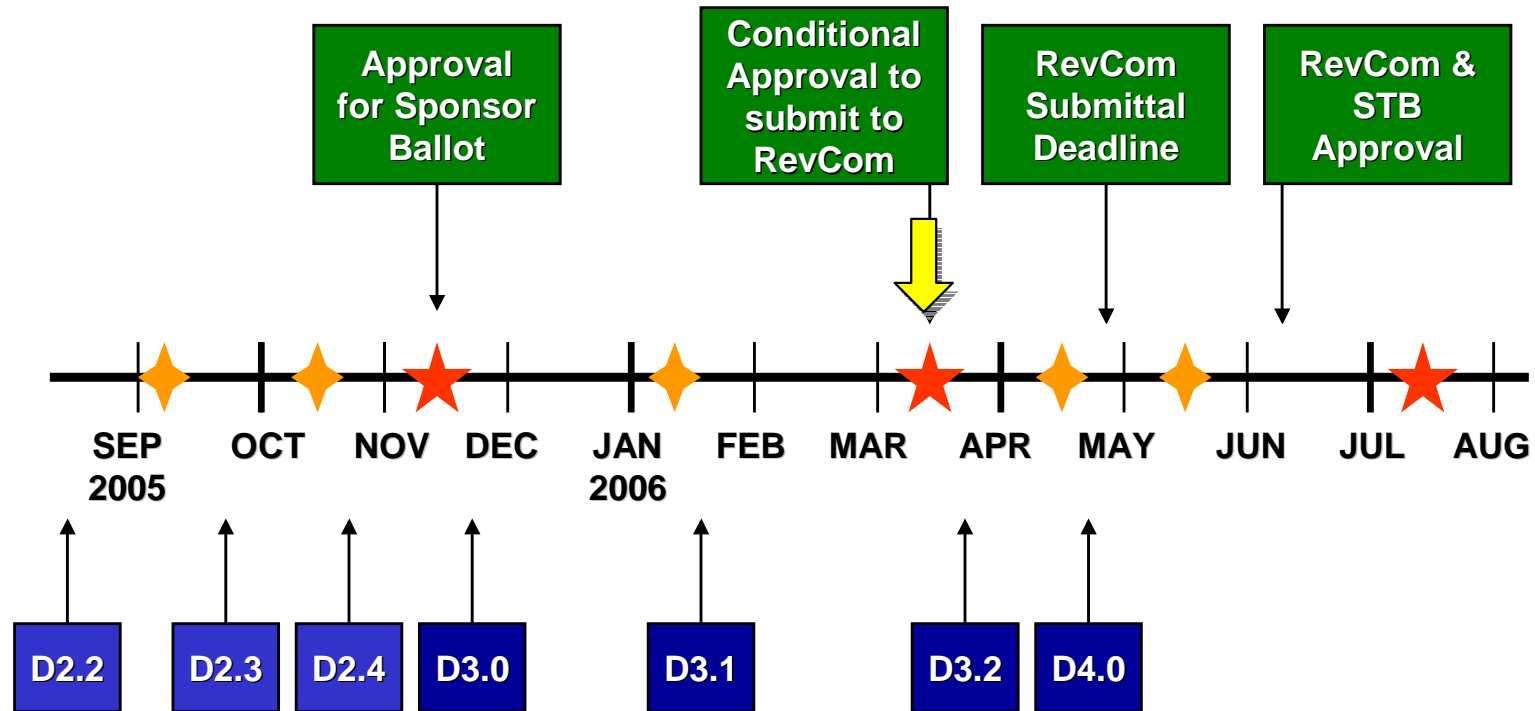

◆ Interim Meeting ★ Plenary Meeting

Future Meetings

- **April 2006 Interim:**
 - **Date:** Week of April 10th (later in the week)
 - **Location:** San Jose area
 - **Goal:** to review D3.2 comments and generate D4.0 to meet RevCom submission deadline
- **May 2006 Interim**
 - **Date:** Week of May 22nd
 - **Location:** Likely to be Korea
 - **Goal:** one day meeting to review D4.0 comments and decide whether or not D4.0 remains on the RevCom agenda
- **July 2006 Plenary**
 - **Date:** Week of July 17th
 - **Location:** San Diego, CA
 - **Goal:** hopefully 802.3an's final meeting/award presentation

Reports

- **ISO/IEC**
 - Report on the February meeting
- **TIA**
- **Editor's report**
 - How did we do on D3.1?

Comment Resolution

Motions

Thank You!