

**IEEE P802.3an Task Force
(10GBASE-T)
Agenda and General Information**

**Vancouver, BC
November 15, 2005**

Brad Booth, Task Force Chair

Please Put Cell Phones on Stun!!



Agenda

- **Welcome**
- **Recording Secretary:**
- **Introductions**
- **Approval of the Minutes**
- **Plans for the Week**
- **Reflector and Web**
- **Ground Rules**
- **IEEE**
 - **Structure**
 - **Bylaws and Rules**
 - **Call for Patents**
 - **IEEE Standards Process**
- **Future Meetings**
- **Reports**
- **Comment Resolution & Presentations**
- **Summary**

10GBASE-T Crew

- **Chair**
 - Brad Booth
- **Editor-in-chief**
 - Sanjay Kasturia
- **Editors:**
 - Eric Lynskey: Auto-negotiation (Clause 28, 55.6)
 - Mike McConnell: MDIO (Clause 45)
 - Jose Tellado: PCS
 - Sandeep Gupta: PMA
 - Terry Cobb: MDI (55.8)
 - Chris Diminico: Channel (55.7)

Plans for the Week

- **COMMENTS??**
 - Respond to all comments submitted on D2.4
- **Sponsor ballot**
 - Approve generation of D3.0
 - Request submission of D3.0 for Sponsor ballot

Reflector and Web

- To subscribe to any of the 10GBASE-T reflectors send an email to:

listserv@ieee.org

with the following in the body of the message:

*subscribe stds-802-3-10GBT <your name>
end*

for example:

*subscribe stds-802-3-10GBT Brad Booth
end*

- P802.3an Task Force web page URL:
<http://www.ieee802.org/3/an/>

Private Area

- **URL:**
 - www.ieee802.org/3/an/private/
- **Access**
 - **Userid: 802.3an**
 - **Password: *******
- **Write it down!!**

Ground Rules

- **Based upon 802.3 rules**
 - Foundation based upon Robert's Rules of Order
- **Anyone in the room may speak**
- **Anyone in the room may vote**
- **RESPECT... give it, get it**
- **NO product pitches**
- **NO corporate pitches**
- **NO prices!!!**
 - This includes costs, ASPs, etc. no matter what the currency
- **NO restrictive notices**

IEEE-SA Standards Board Bylaws on Patents in Standards

6. Patents

IEEE standards may include the known use of essential patents and patent applications provided the IEEE receives assurance from the patent holder or applicant with respect to patents whose infringement is, or in the case of patent applications, potential future infringement the applicant asserts will be, unavoidable in a compliant implementation of either mandatory or optional portions of the standard [essential patents]. This assurance shall be provided without coercion and prior to approval of the standard (or reaffirmation when a patent or patent application becomes known after initial approval of the standard). This assurance shall be a letter that is in the form of either:

a) A general disclaimer to the effect that the patentee will not enforce any of its present or future patent(s) whose use would be required to implement either mandatory or optional portions of the proposed IEEE standard against any person or entity complying with the standard; or

b) A statement that a license for such implementation will be made available without compensation or under reasonable rates, with reasonable terms and conditions that are demonstrably free of any unfair discrimination.

This assurance shall apply, at a minimum, from the date of the standard's approval to the date of the standard's withdrawal and is irrevocable during that period.

Approved by IEEE-SA Standards Board – March 2003 (Revised March 2005)

Inappropriate Topics for IEEE WG Meetings

- **Don't discuss the validity/essentiality of patents/patent claims**
- **Don't discuss the cost of specific patent use**
- **Don't discuss licensing terms or conditions**
- **Don't discuss product pricing, territorial restrictions, or market share**
- **Don't discuss ongoing litigation or threatened litigation**
- **Don't be silent if inappropriate topics are discussed... do formally object.**

If you have questions, contact the IEEE-SA Standards Board Patent Committee Administrator at patcom@ieee.org or visit <http://standards.ieee.org/board/pat/index.html>

This slide set is available at
<http://standards.ieee.org/board/pat/pat-slideset.ppt>

Approved by IEEE-SA Standards Board – March 2003 (Revised March 2005)

IEEE Structure

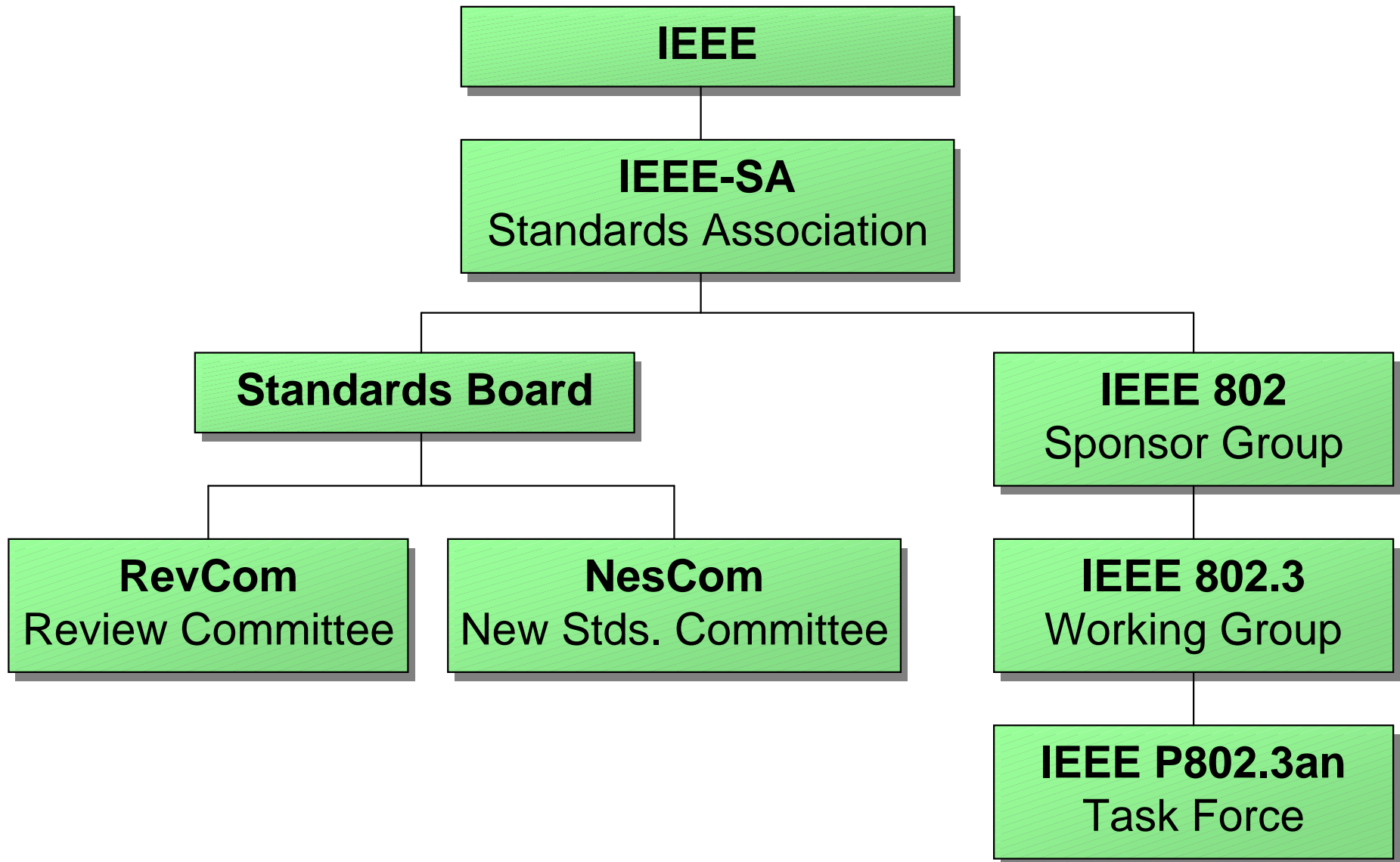

Bylaws and Rules

- **Bylaws of the IEEE Standards Association (IEEE-SA):**

<http://standards.ieee.org/sa/sa-bylaws.pdf>

- **Bylaws of the IEEE-SA Standards Board:**

<http://standards.ieee.org/guides/bylaws/sb-bylaws.pdf>

- **IEEE LAN/MAN Standards Committee (LMSC) Operating Rules:**

<http://www.ieee802.org/rules.pdf>

- **IEEE 802.3 Working Group Operating Rules:**

<http://www.ieee802.org/3/rules/>

IEEE Standards Process

Study Group Formation

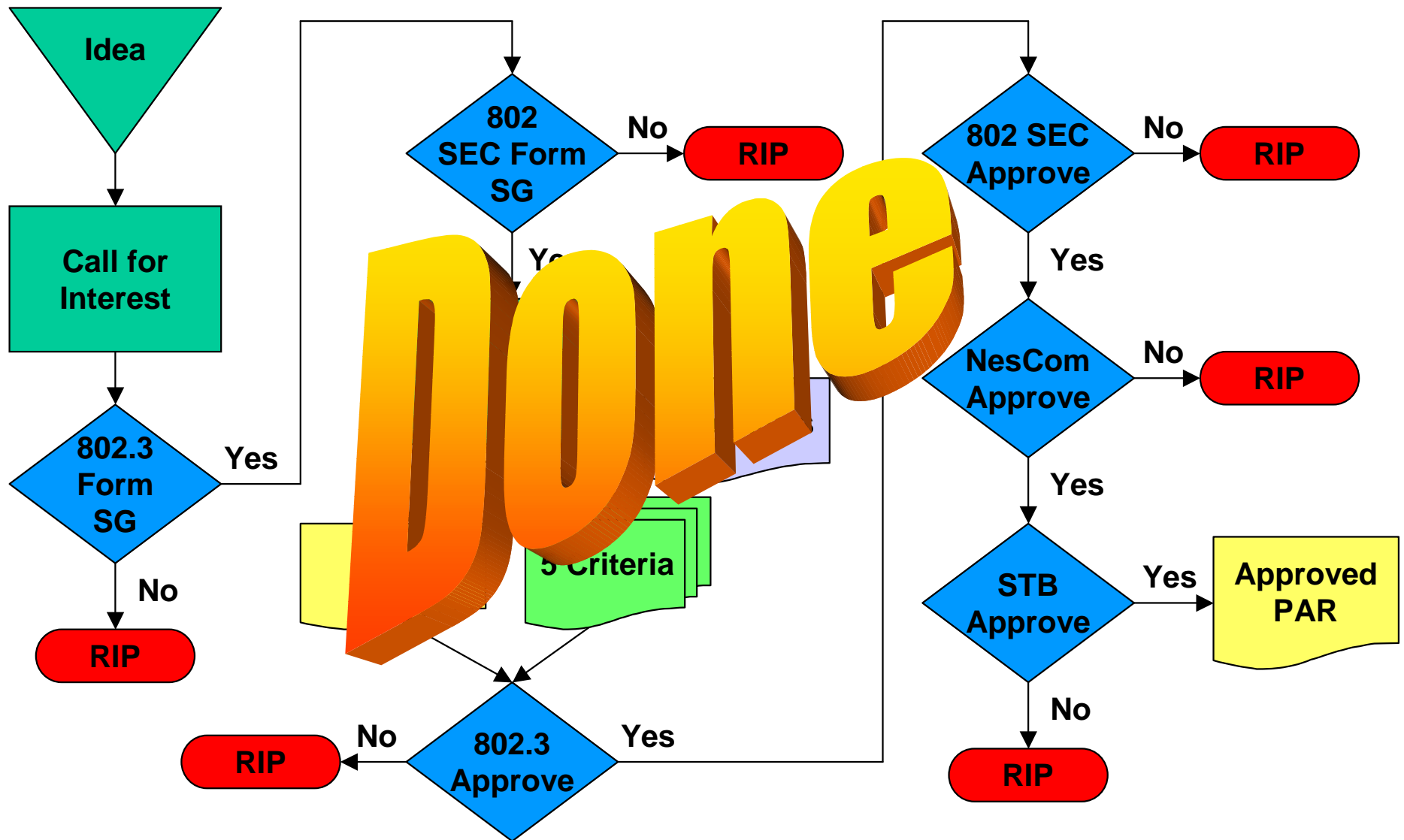

IEEE Standards Process

Task Force Review

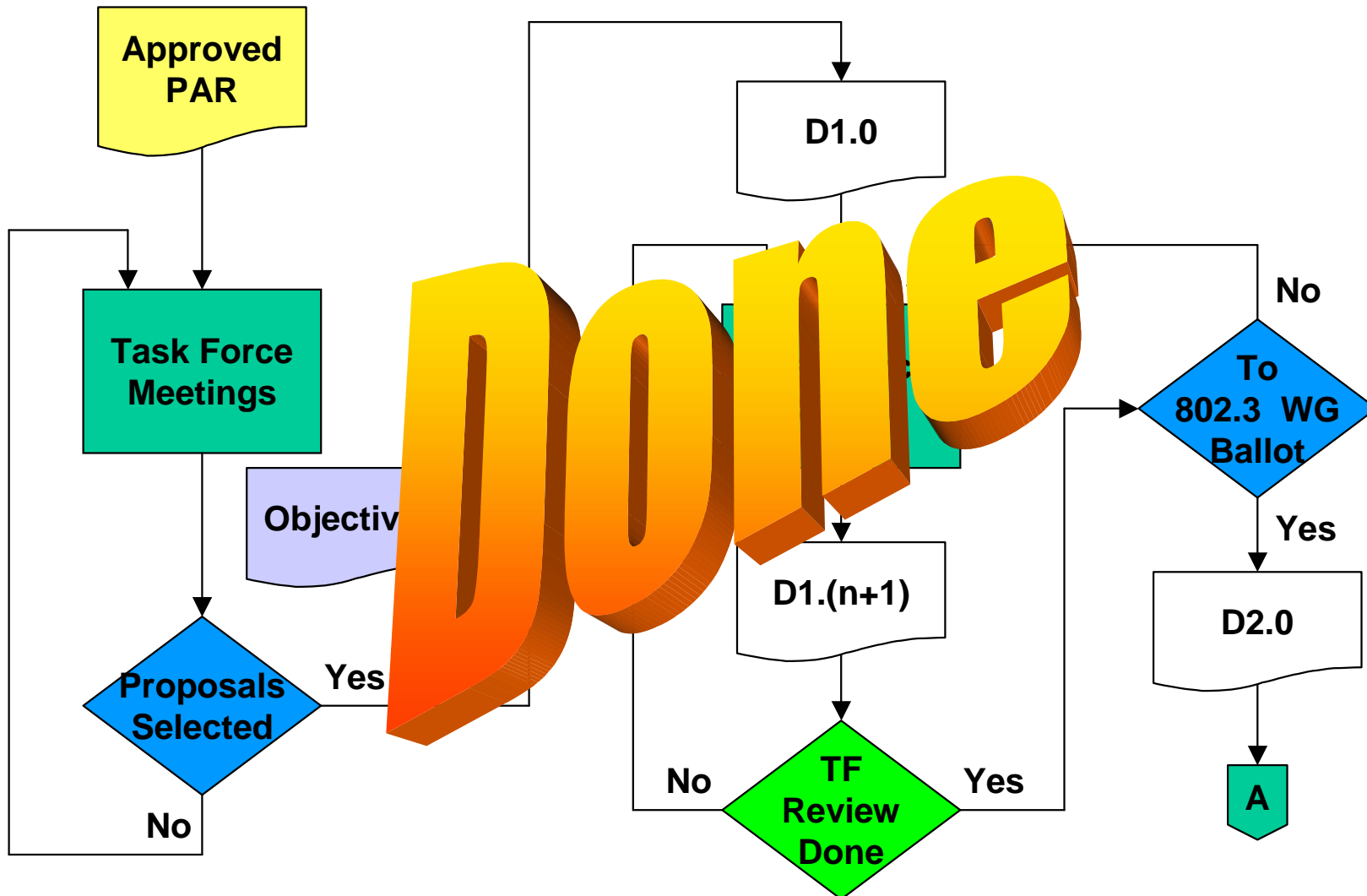

IEEE Standards Process

Working Group Ballot

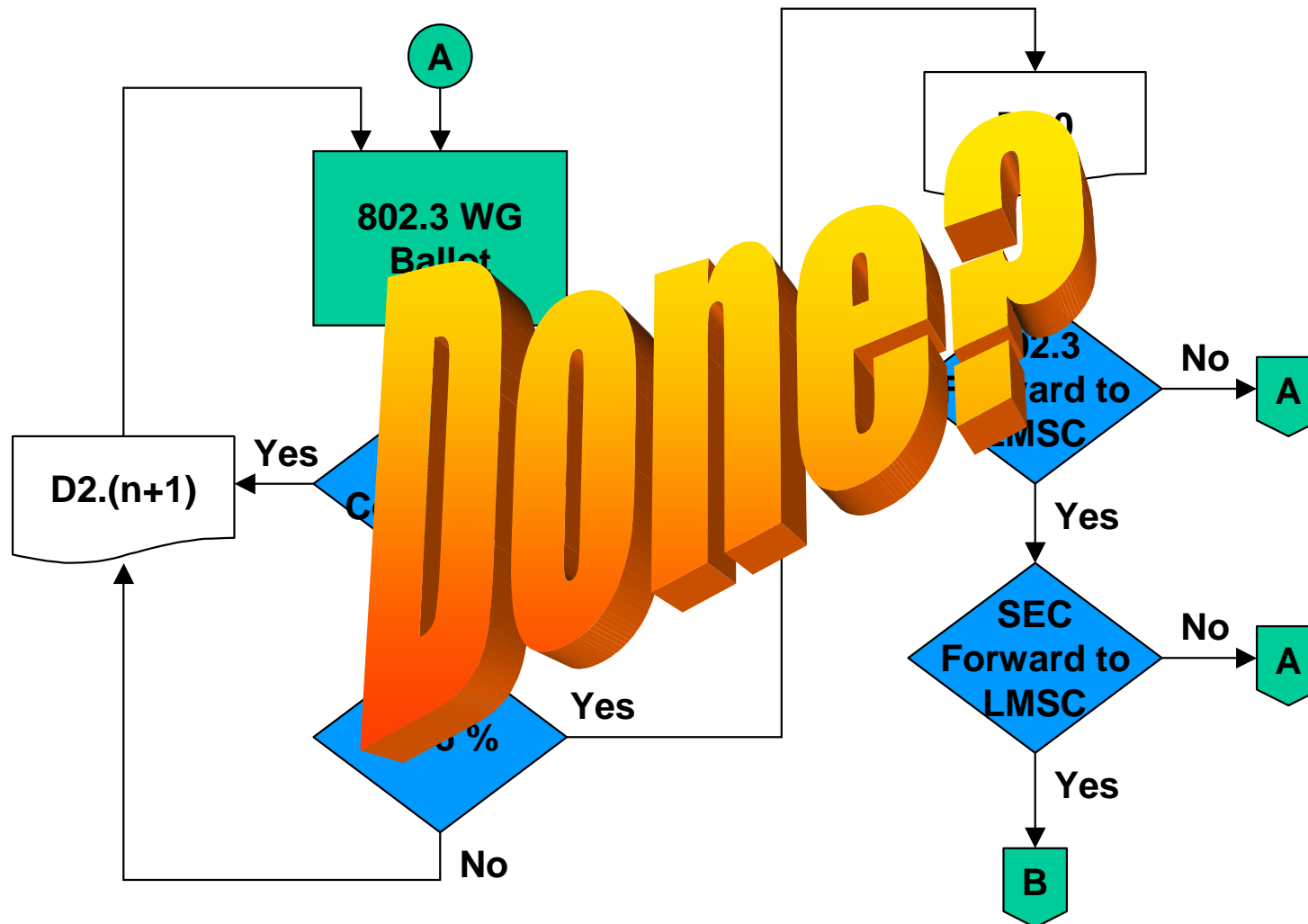

IEEE Standards Process

Sponsor Ballot

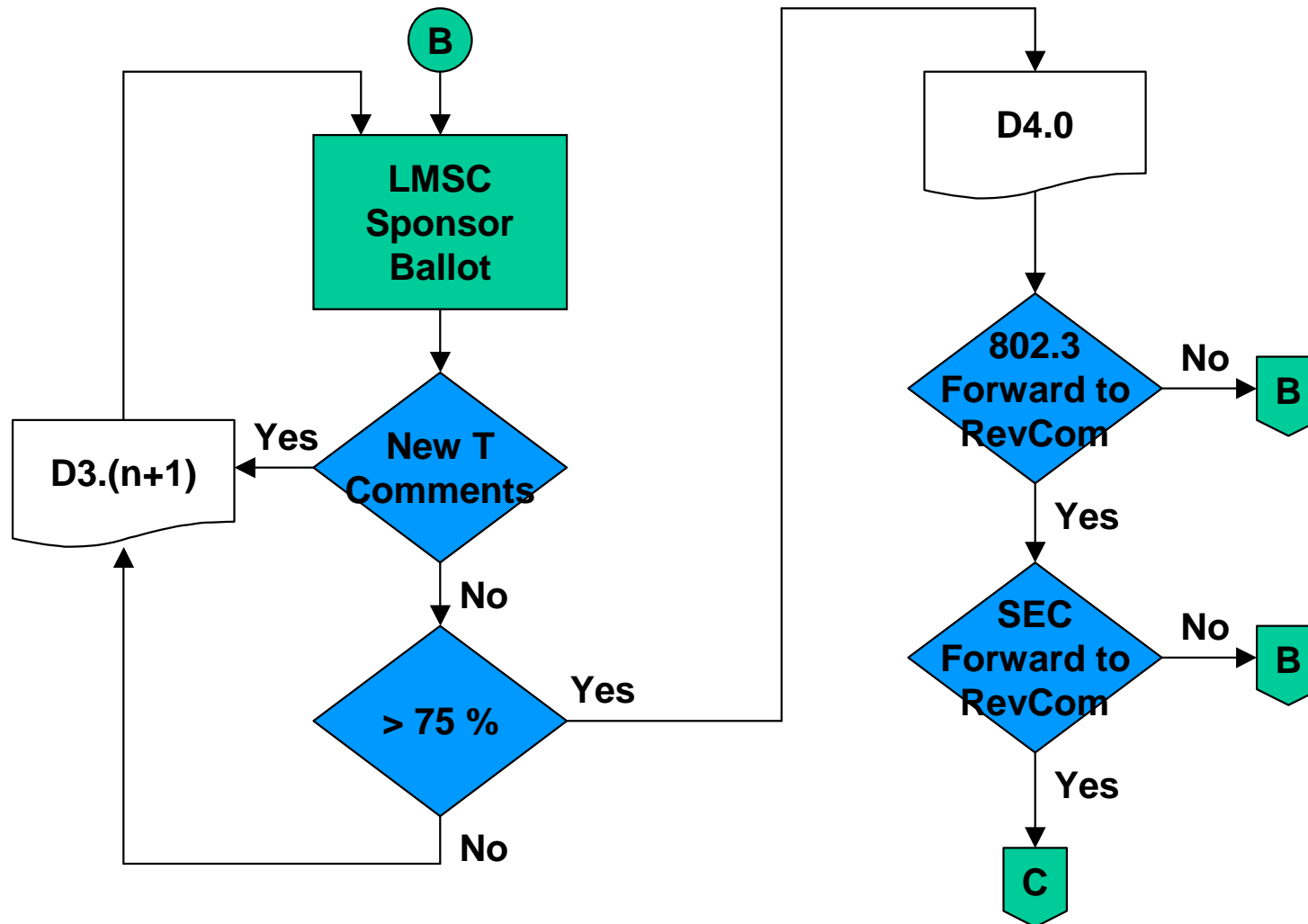

IEEE Standards Process

Standard Approval

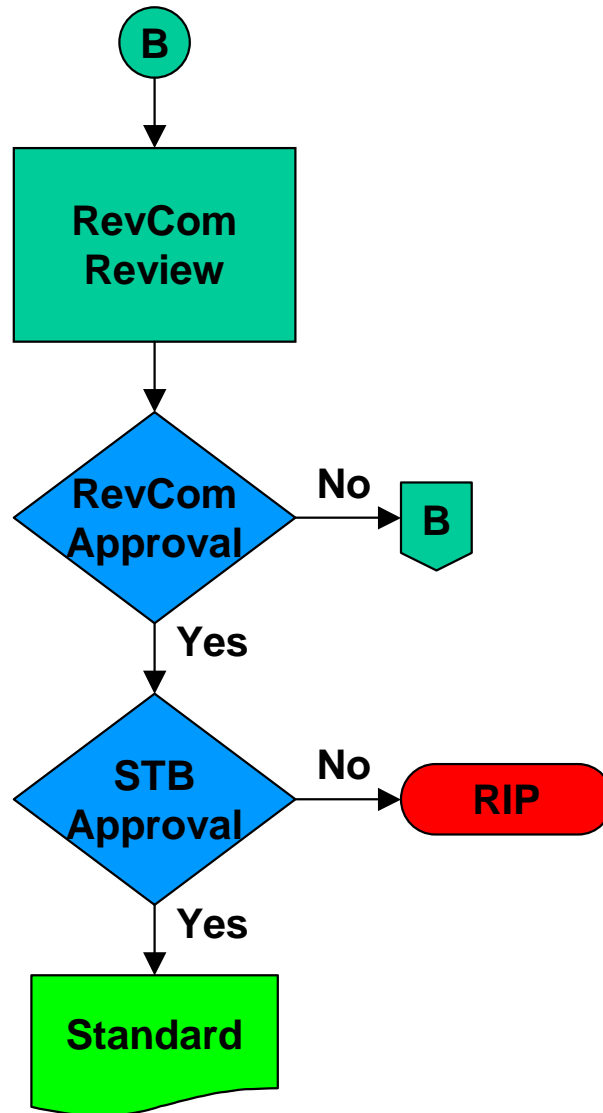

P802.3an Objectives

- **Preserve the 802.3/Ethernet frame format at the MAC Client service interface**
- **Preserve min. and max. frame size of current 802.3 Std.**
- **Support full duplex operation only**
- **Support star-wired local area networks using point-to-point links and structured cabling topologies**
- **Support a speed of 10.000 Gb/s at the MAC/PLS service interface**
- **Select copper media from ISO/IEC 11801:2002, with any appropriate augmentation to be developed through work of 802.3 in conjunction with SC25/WG3**
- **Support Clause 28 auto-negotiation**
- **Support coexistence with 802.3af**
- **To not support 802.3ah (EFM) OAM unidirectional operation**
- **Meet CISPR/FCC Class A**

P802.3an Objectives (cont.)

- **Support operation over 4-connector structured 4-pair, twisted-pair copper cabling for all supported distances and Classes**
- **Define a single 10 Gb/s PHY that would support links of:**
 - **At least 100 m on four-pair Class F balanced copper cabling**
 - **At least 55 m to 100 m on four-pair Class E balanced copper cabling**
- **Support a BER of 10^{-12} on all supported distances and Classes**

P802.3an Timeline

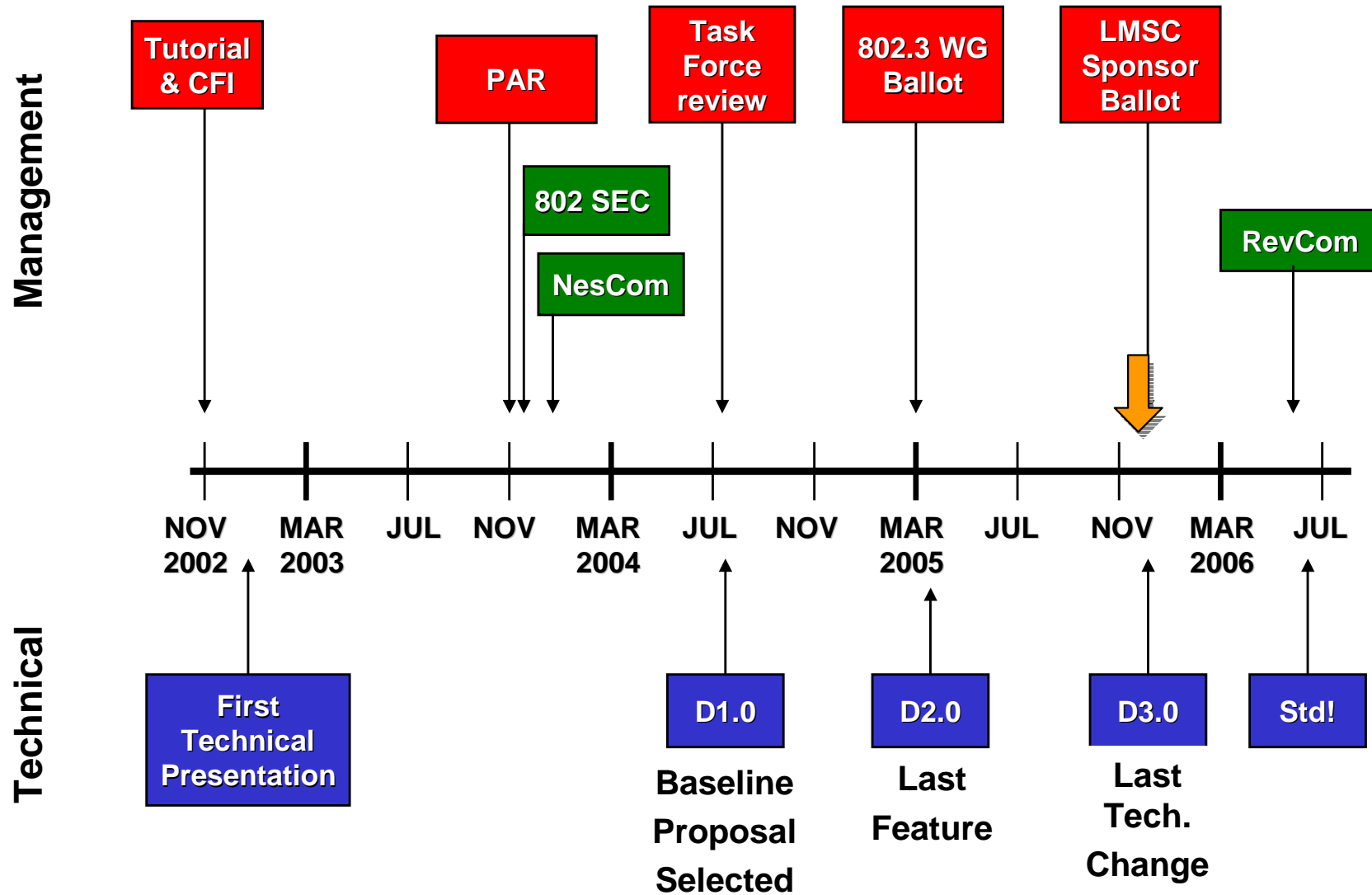

P802.3an Timeline Magnified

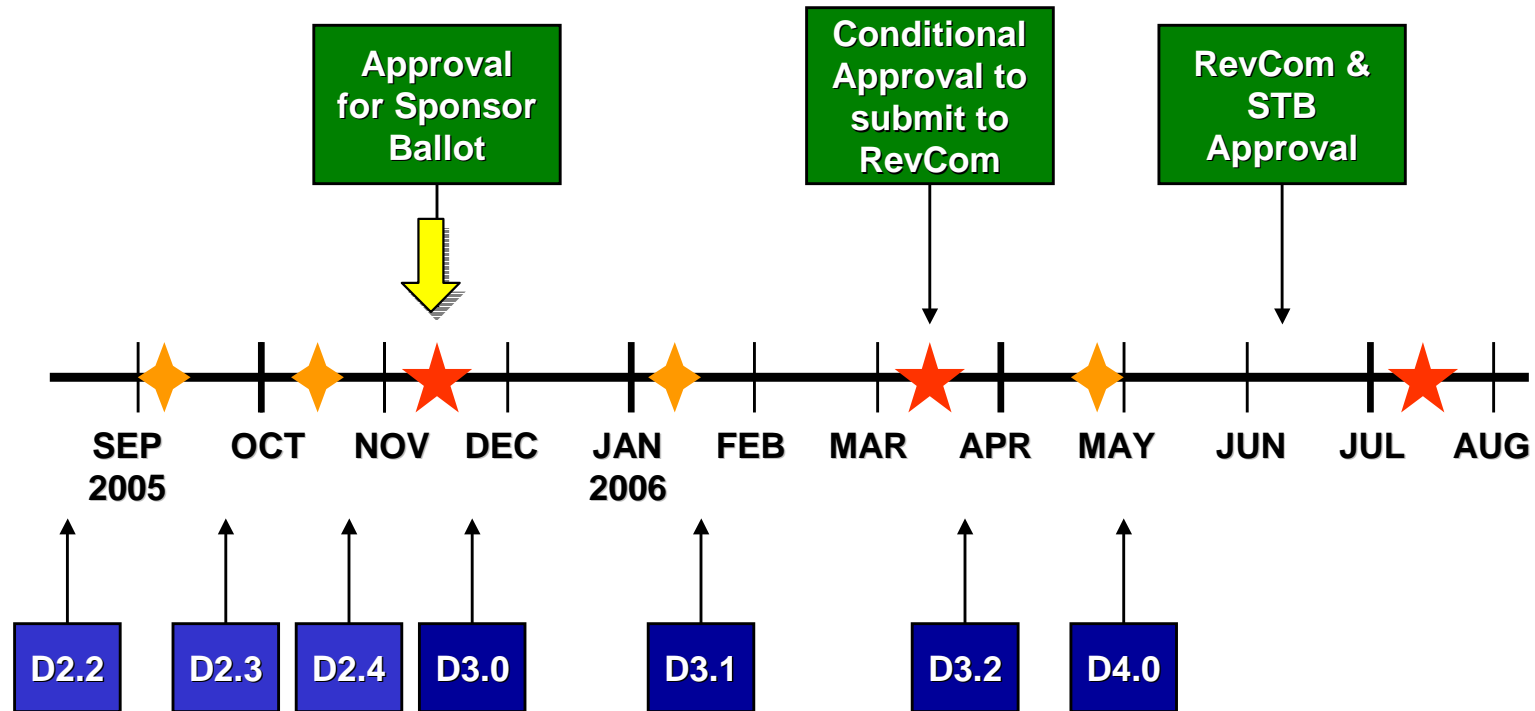

◆ Interim Meeting ★ Plenary Meeting

Future Meetings

- **January 2006 Interim:**
 - **Location and date to be announced**
- **March 2006 Plenary:**
 - **Date: Week of the 6th**
 - **Location: Denver, CO**
 - **Hotel: Hyatt Regency @ Colorado Convention Center**
- **April 2006 Interim:**
 - **Date: TBD (late April)**
 - **Host required**
 - **Goal: to close out D3.2 comments to meet RevCom submission deadline**

Reports

- **ISO/IEC**
 - Report on the September meeting
- **TIA**
- **Editor's report**
 - How did we do on D2.4?

Comment Resolution

Motions

Thank You!