



IEEE 802.3az

Energy Efficient Ethernet

Agenda and General Information

Portland, OR
January, 2008

Mike Bennett
mjbennett@ieee.org

Agenda

- Welcome and Introductions
- Approve Meeting Minutes
- Sign-in Rules
- Goals for this Meeting
- Reflector and Web
- Ground Rules
- IEEE
 - Structure
 - Bylaws and Rules
 - Call for Patents
 - IEEE Standards Process
- Presentations
- Discussion and Motions
- Future Meetings

IEEE 802.3az EEE Contacts

■ Task Force Chair

■ Mike Bennett (mjbennett@ieee.org)

■ Web Master

■ Bruce Nordman (bnordman@lbl.gov)

■ Secretary

■ Kory Sefidvash (khorvash@broadcom.com)

Sign-in rules

- Red/Blue book setup with the addition of the affiliation sheets
 - Now three sections to check
 - More about this when the books go around
- Don't forget the sign-in sheet as attendees need to go in the meeting minutes as well

Remember to Declare Your Affiliation

■ From the IEEE SA Standards Board By-laws

□ 5.2.1.5 Disclosure of affiliation (<http://standards.ieee.org/guides/bylaws/sect5.html#5.2.1.5>)

- Every member and participant in a working group, Sponsor ballot, or other standards development activity shall disclose his or her affiliation. An individual is deemed "affiliated" with any individual or entity that has been, or will be, financially or materially supporting that individual's participation in a particular IEEE standards activity. This includes, but is not limited to, his or her employer and any individual or entity that has or will have, either directly or indirectly, requested, paid for, or otherwise sponsored his or her participation. Failure to disclose every such affiliation may result in complete or partial loss of rights to participate in IEEE-SA activities. An individual is not excused from compliance with this policy by reason of any claim of a conflicting obligation (whether contractual or otherwise) that prohibits disclosure of affiliation.

■ From the IEEE SA Standards Board Operations Manual

□ 5.3.3.1 Disclosure of affiliation (<http://standards.ieee.org/guides/opman/sect5.html#5.3.3.1>)

- Each participant's affiliation shall be disclosed at any working group or project meeting. The chair or the chair's delegate shall inform the meeting of the requirement for disclosure of affiliation (see [5.2.1.5](#) of the *IEEE-SA Standards Board Bylaws*). This shall be via a sign-in (e.g., sign-in sheet, electronic sign-in, verbal disclosure, or electronic communication) that provides for disclosure of employer and any other affiliation, a reminder of the definition of affiliation, and possible penalties for non-compliance.

Whenever an individual is aware that the ownership of his or her employer or other affiliation may be material to the process, or when the Sponsor or the IEEE-SA Standards Board requests, that individual shall also declare the "ultimate parent entity" of their affiliation. The ultimate parent entity is an entity that directly or indirectly, through one or more intermediaries, controls the entity identified as the individual's affiliation. For the purposes of this definition, the term "control" and its derivatives, with respect to for-profit entities, means the legal, beneficial or equitable ownership, directly or indirectly, of more than fifty percent (50%) of the capital stock (or other ownership interest, if not a corporation) of an entity ordinarily having voting rights. "Control" and its derivatives, with respect to nonprofit entities, means the power to elect or appoint more than fifty percent (50%) of the Board of Directors of an entity.

□ 5.3.3.2 False or misleading disclosure (<http://standards.ieee.org/guides/opman/sect5.html#5.3.3.2>)

- A meeting attendee who fails to disclose affiliation shall not accrue any membership rights, including rights of or towards voting membership, until such disclosures have been made. The chair shall review the adequacy of disclosures. Failure to disclose affiliation, or materially false or misleading disclosure of affiliation, shall result in loss of membership privileges and may also result in loss of other participation privileges within the IEEE-SA for such participants and any affiliated entities

IEEE 802.3 Voting privileges

- The rules regarding obtaining and maintaining that privilege are found here: <http://www.ieee802.org/3/rules/member.html>
- To become a voter:
 - Contact information must be current in the 802.3 database
 - You must attend and sign attendance book for at least 75% of sessions of two 802.3 WG plenary meetings (within the last four)
 - Full attendance at a two-day 802.3 WG Interim can be substituted for one Plenary
 - Request to become a voter during the opening or closing Plenary meeting when solicited by the Chair from the “potential voters list”
- To remain a voter
 - Contact information must be current in the 802.3 database
 - 75% attendance during at least two of the last four plenary meetings
 - Attendance at an interim can substitute for attendance at no more than 1 plenary
 - Participate in Working Group ballots.
 - You can be dropped for lack of participation !

Goals for this Meeting

- Identify the challenges for this project
 - Document structure
 - Architecture
- Continue hearing proposals
- Lay the ground work for the next meeting

Reflector and Web

- To subscribe to the Energy Efficient Ethernet (EEE) reflector, send your request to:

ListServ@ieee.org

with the following in the body of the message (do not include “<>”):

*subscribe stds-802-3-eee <yourfirstname> <yourlastname>
end*

- Send EEE reflector messages to:

stds-802-3-eee@listserv.ieee.org

- For complete instructions on reflector usage, subscription, and unsubscription:

<http://www.ieee802.org/3/az/reflector.html>

- EEE web page URL:

<http://www.ieee802.org/3/az/index.html>

Ground Rules

- Based upon IEEE 802.3 Rules
 - Meetings conducted using Robert's Rules of Order
 - Anyone in the room may speak
 - Anyone in the room may vote
- **RESPECT**... give it, get it
- NO product pitches
- NO corporate pitches
- NO prices!!!
 - This includes costs, Average Sales Prices (ASP), etc. no matter what the currency
- NO restrictive notices

Bylaws and Rules

- **IEEE-SA Operations Manual:**

- <http://standards.ieee.org/sa/sa-om.pdf>

- **IEEE-SA Standards Board Bylaws:**

- <http://standards.ieee.org/guides/bylaws/sb-bylaws.pdf>

- **IEEE-SA Standards Board Operations Manual:**

- <http://standards.ieee.org/guides/opman/sb-om.pdf>

- **LAN/MAN Standards Committee (LMSC) Policies and Procedures:**

- <http://ieee802.org/policies-and-procedures.pdf>

- **IEEE 802.3 Working Group Operating Rules:**

- http://ieee802.org/3/rules/P802_3_rules.pdf

Instructions for the WG Chair on Patent Policies

The IEEE-SA strongly recommends that at each WG meeting the chair or a designee:

- ❑ **Show slides #1 through #5 of this presentation**
- ❑ **Advise the WG attendees that:**
 - The IEEE's patent policy is consistent with the ANSI patent policy and is described in Clause 6 of the *IEEE-SA Standards Board Bylaws*;
 - Early identification of patent claims which may be essential for the use of standards under development is encouraged;
 - There may be Essential Patent Claims of which the IEEE is not aware. Additionally, neither the IEEE, the WG, nor the WG chair can ensure the accuracy or completeness of any assurance or whether any such assurance is, in fact, of a Patent Claim that is essential for the use of the standard under development.
- ❑ **Instruct the WG Secretary to record in the minutes of the relevant WG meeting:**
 - That the foregoing information was provided and the five slides were shown;
 - That the chair or designee provided an opportunity for participants to identify patent claim(s)/patent application claim(s) and/or the holder of patent claim(s)/patent application claim(s) that the participant believes may be essential for the use of that standard;
 - Any responses that were given, specifically the patent claim(s)/patent application claim(s) and/or the holder of the patent claim(s)/patent application claim(s) that were identified (if any) and by whom.
 - It is recommended that the WG chair review the guidance in the *Standards Companion* on inclusion of potential Essential Patent Claims by normative reference.

Note: **WG** includes Working Groups, Task Groups, and other standards-developing committees.

Highlights of the *IEEE-SA Standards Board Bylaws on Patents in Standards*

- ❑ **Participants have a duty to tell the IEEE if they know (based on personal awareness) of potentially Essential Patent Claims they or their employer own**
- ❑ **Participants are encouraged to tell the IEEE if they know of potentially Essential Patent Claims owned by others**
 - This encouragement is particularly strong as the third party may not be a participant in the standards process
- ❑ **Working Group required to request assurance**
- ❑ **Early assurance is encouraged**
- ❑ **Terms of assurance shall be either:**
 - Reasonable and nondiscriminatory, with or without monetary compensation; or,
 - A statement of non-assertion of patent rights
- ❑ **Assurances**
 - Shall be provided on the IEEE-SA Standards Board approved LOA form
 - May optionally include not-to-exceed rates, terms, and conditions
 - Shall not be circumvented through sale or transfer of patents
 - Shall be brought to the attention of any future assignees or transferees
 - Shall apply to Affiliates unless explicitly excluded
 - Are irrevocable once submitted and accepted
 - Shall be supplemented if Submitter becomes aware of other potential Essential Patent Claims
- ❑ **A “Blanket Letter of Assurance” may be provided at the option of the patent holder**
- ❑ **A patent holder has no duty to perform a patent search**
- ❑ **Full policy available at <http://standards.ieee.org/guides/bylaws/sect6-7.html#6>**

IEEE-SA Standards Board Bylaws on Patents in Standards

6.2 Policy

IEEE standards may be drafted in terms that include the use of Essential Patent Claims. If the IEEE receives notice that a [Proposed] IEEE Standard may require the use of a potential Essential Patent Claim, the IEEE shall request licensing assurance, on the IEEE Standards Board approved Letter of Assurance form, from the patent holder or patent applicant. The IEEE shall request this assurance without coercion.

The Submitter of the Letter of Assurance may, after Reasonable and Good Faith Inquiry, indicate it is not aware of any Patent Claims that the Submitter may own, control, or have the ability to license that might be or become Essential Patent Claims. If the patent holder or patent applicant provides an assurance, it should do so as soon as reasonably feasible in the standards development process. This assurance shall be provided prior to the Standards Board's approval of the standard. This assurance shall be provided prior to a reaffirmation if the IEEE receives notice of a potential Essential Patent Claim after the standard's approval or a prior reaffirmation. An asserted potential Essential Patent Claim for which an assurance cannot be obtained (e.g., a Letter of Assurance is not provided or the Letter of Assurance indicates that assurance is not being provided) shall be referred to the Patent Committee.

A Letter of Assurance shall be either:

- a) A general disclaimer to the effect that the Submitter without conditions will not enforce any present or future Essential Patent Claims against any person or entity making, using, selling, offering to sell, importing, distributing, or implementing a compliant implementation of the standard; or
- b) A statement that a license for a compliant implementation of the standard will be made available to an unrestricted number of applicants on a worldwide basis without compensation or under reasonable rates, with reasonable terms and conditions that are demonstrably free of any unfair discrimination. At its sole option, the Submitter may provide with its assurance any of the following:
 - (i) a not-to-exceed license fee or rate commitment, (ii) a sample license agreement, or (iii) one or more material licensing terms.

IEEE-SA Standards Board Bylaws on Patents in Standards

Copies of an Accepted LOA may be provided to the working group, but shall not be discussed, at any standards working group meeting.

The Submitter and all Affiliates (other than those Affiliates excluded in a Letter of Assurance) shall not assign or otherwise transfer any rights in any Essential Patent Claims that are the subject of such Letter of Assurance that they hold, control, or have the ability to license with the intent of circumventing or negating any of the representations and commitments made in such Letter of Assurance.

The Submitter of a Letter of Assurance shall agree (a) to provide notice of a Letter of Assurance either through a Statement of Encumbrance or by binding any assignee or transferee to the terms of such Letter of Assurance; and (b) to require its assignee or transferee to (i) agree to similarly provide such notice and (ii) to bind its assignees or transferees to agree to provide such notice as described in (a) and (b).

This assurance shall apply to the Submitter and its Affiliates except those Affiliates the Submitter specifically excludes on the relevant Letter of Assurance.

If, after providing a Letter of Assurance to the IEEE, the Submitter becomes aware of additional Patent Claim(s) not already covered by an existing Letter of Assurance that are owned, controlled, or licensable by the Submitter that may be or become Essential Patent Claim(s) for the same IEEE Standard but are not the subject of an existing Letter of Assurance, then such Submitter shall submit a Letter of Assurance stating its position regarding enforcement or licensing of such Patent Claims. For the purposes of this commitment, the Submitter is deemed to be aware if any of the following individuals who are from, employed by, or otherwise represent the Submitter have personal knowledge of additional potential Essential Patent Claims, owned or controlled by the Submitter, related to a [Proposed] IEEE Standard and not already the subject of a previously submitted Letter of Assurance: (a) past or present participants in the development of the [Proposed] IEEE Standard, or (b) the individual executing the previously submitted Letter of Assurance.

IEEE-SA Standards Board Bylaws on Patents in Standards

The assurance is irrevocable once submitted and accepted and shall apply, at a minimum, from the date of the standard's approval to the date of the standard's withdrawal.

The IEEE is not responsible for identifying Essential Patent Claims for which a license may be required, for conducting inquiries into the legal validity or scope of those Patent Claims, or for determining whether any licensing terms or conditions are reasonable or non-discriminatory.

Nothing in this policy shall be interpreted as giving rise to a duty to conduct a patent search. No license is implied by the submission of a Letter of Assurance.

In order for IEEE's patent policy to function efficiently, individuals participating in the standards development process: (a) shall inform the IEEE (or cause the IEEE to be informed) of the holder of any potential Essential Patent Claims of which they are personally aware and that are not already the subject of an existing Letter of Assurance, owned or controlled by the participant or the entity the participant is from, employed by, or otherwise represents; and (b) should inform the IEEE (or cause the IEEE to be informed) of any other holders of such potential Essential Patent Claims that are not already the subject of an existing Letter of Assurance.

Other Guidelines for IEEE WG Meetings

- All IEEE-SA standards meetings shall be conducted in compliance with all applicable laws, including antitrust and competition laws.
- Don't discuss the interpretation, validity, or essentiality of patents/patent claims.
- Don't discuss specific license rates, terms, or conditions.
 - Relative costs, including licensing costs of essential patent claims, of different technical approaches may be discussed in standards development meetings.
 - Technical considerations remain primary focus
- Don't discuss fixing product prices, allocation of customers, or dividing sales markets.
- Don't discuss the status or substance of ongoing or threatened litigation.
- Don't be silent if inappropriate topics are discussed... do formally object.

If you have questions, contact the IEEE-SA Standards Board Patent Committee Administrator at patcom@ieee.org or visit <http://standards.ieee.org/board/pat/index.html>

See *IEEE-SA Standards Board Operations Manual*, clause 5.3.10 and "Promoting Competition and Innovation: What You Need to Know about the IEEE Standards Association's Antitrust and Competition Policy" for more details.

This slide set is available at <http://standards.ieee.org/board/pat/pat-slideset.ppt>

IEEE Structure

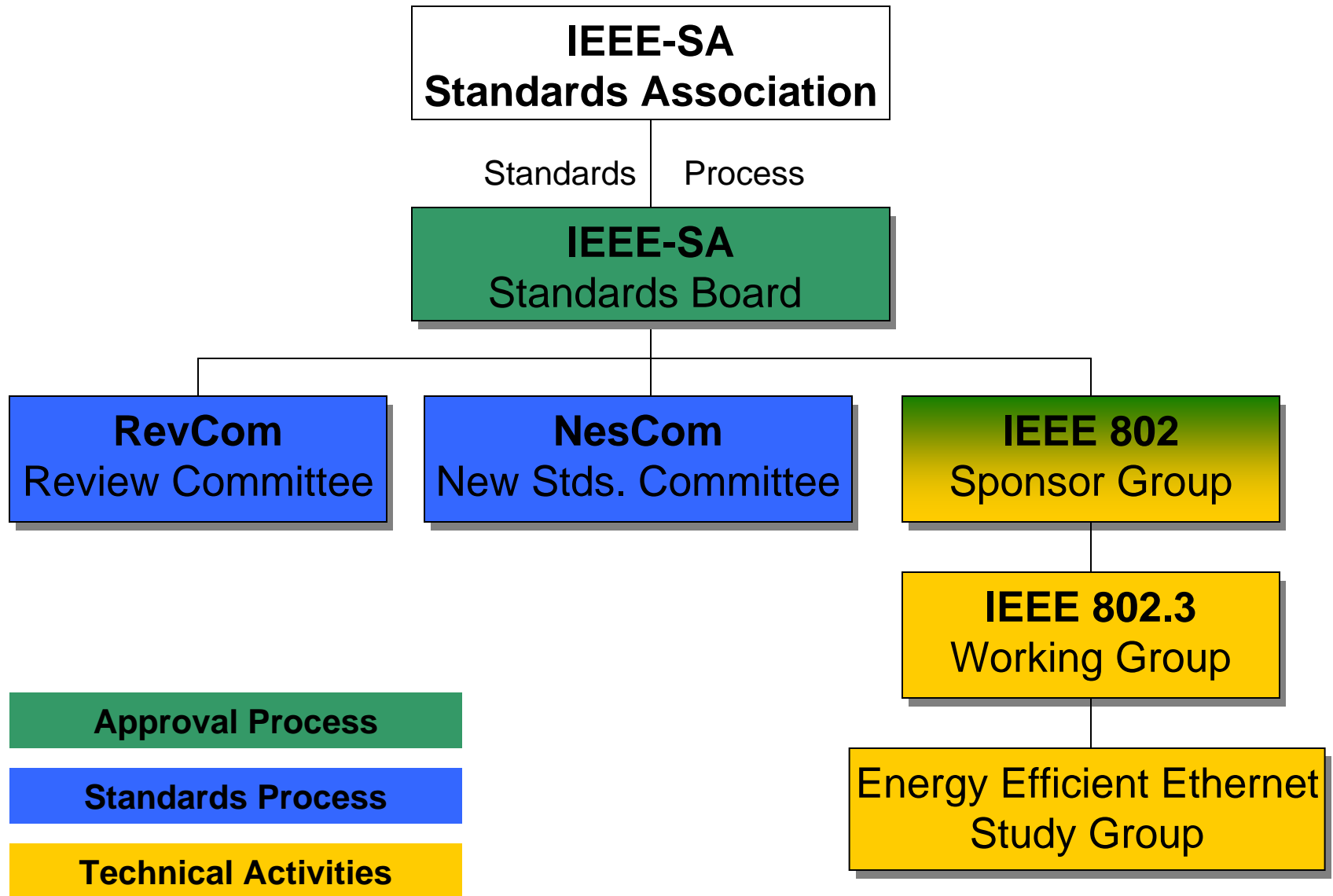

Overview of IEEE 802.3 Standards Process (1/5)

Study Group Phase

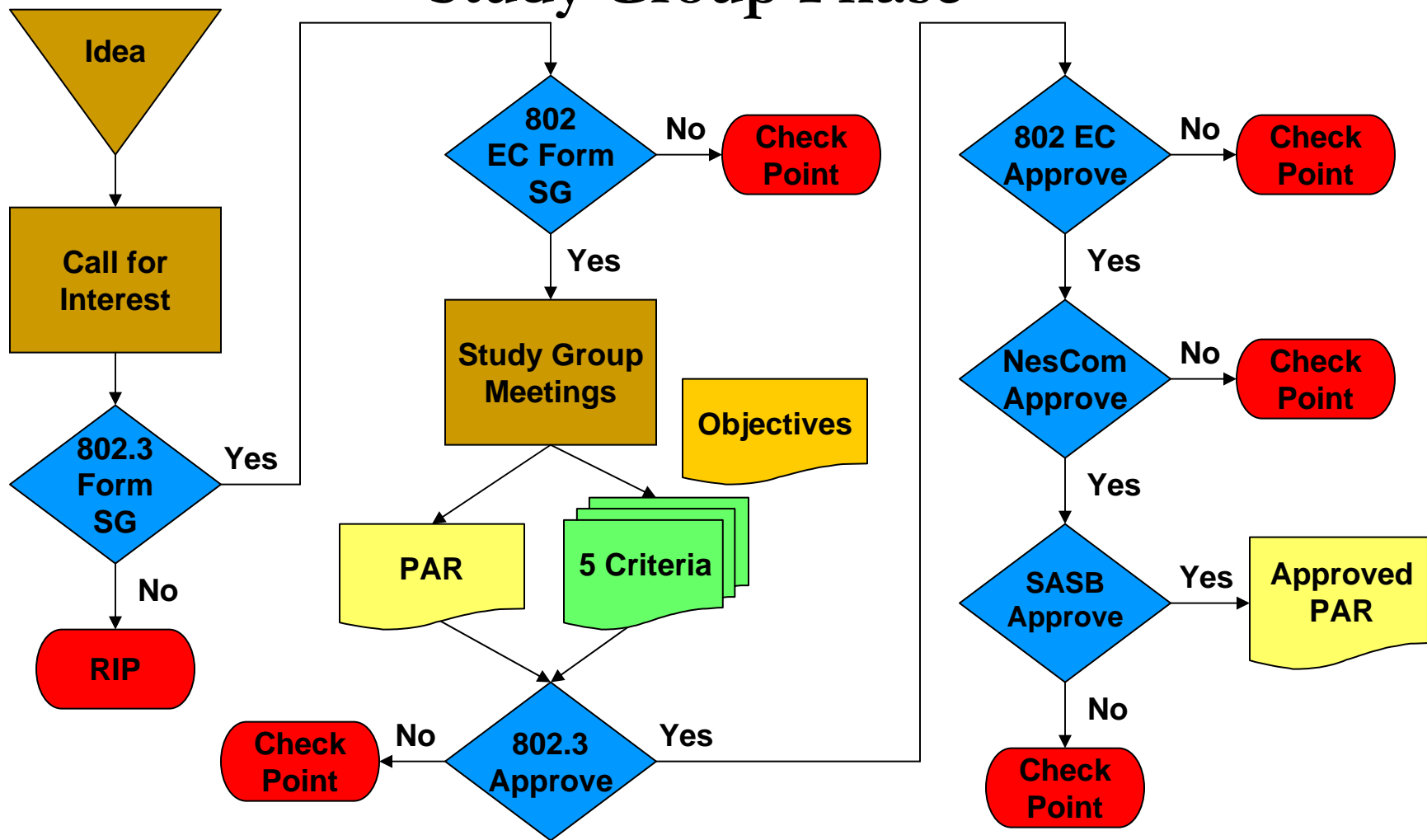

Note: At "Check Point", either the activity is ended, or there may be various options that would allow reconsideration of the approval.

Overview of IEEE 802.3 Standards Process (2/5)

Task Force Comment Phase

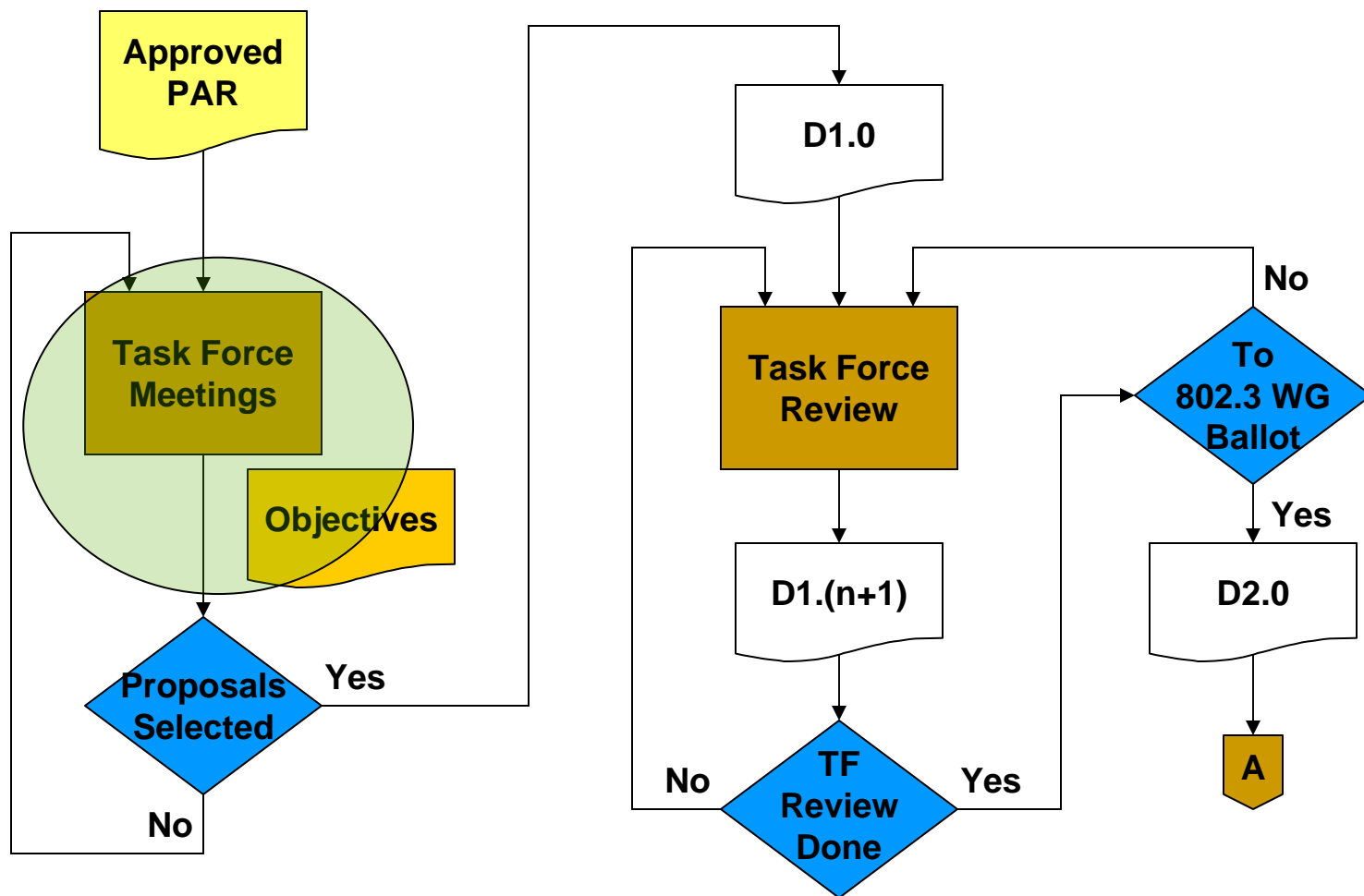

Overview of IEEE 802.3 Standards Process (3/5)

Working Group Ballot Phase

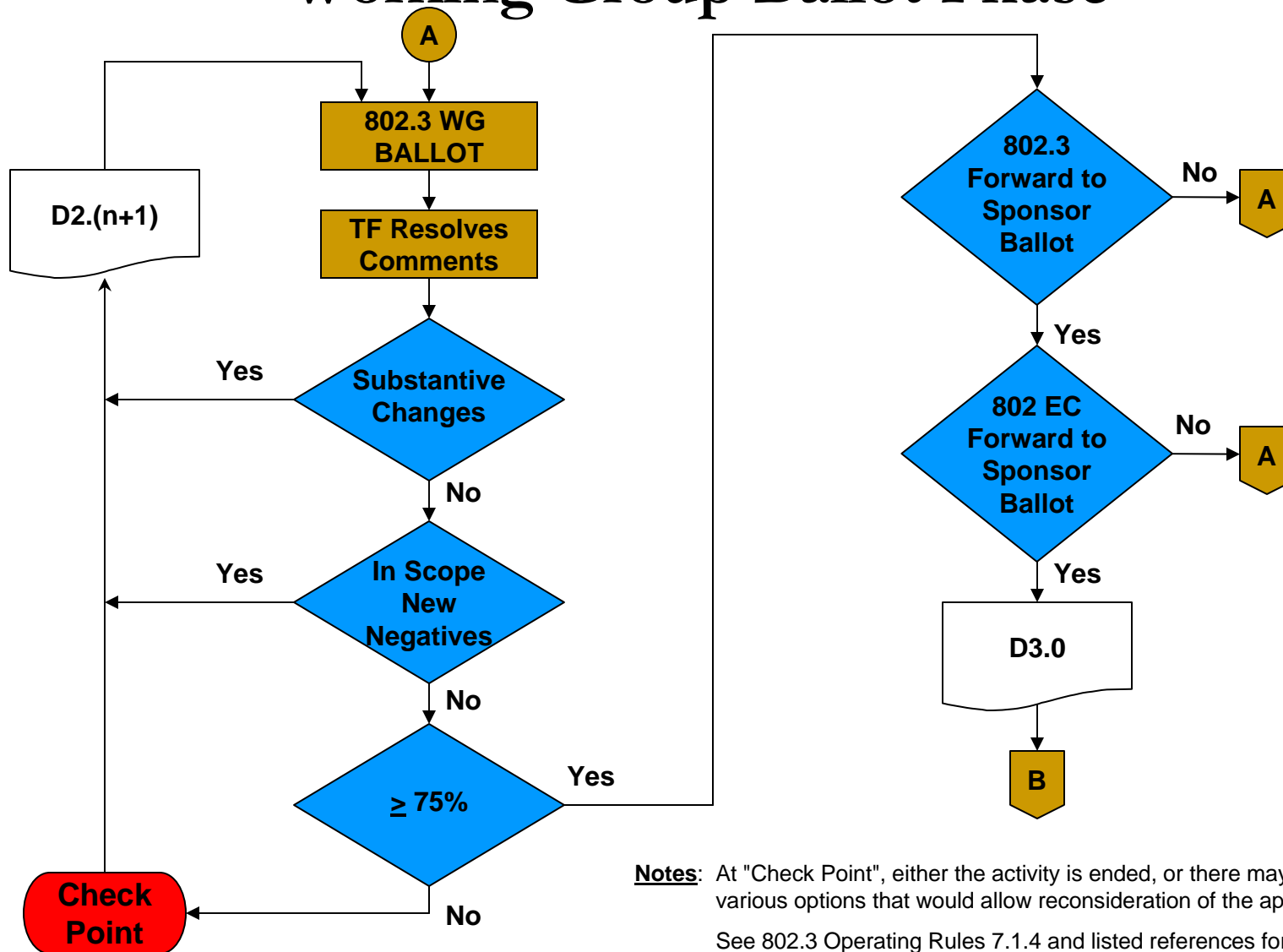

Notes: At "Check Point", either the activity is ended, or there may be various options that would allow reconsideration of the approval.

See 802.3 Operating Rules 7.1.4 and listed references for complete description

Overview of IEEE 802.3 Standards Process (4/5)

Sponsor Ballot Phase

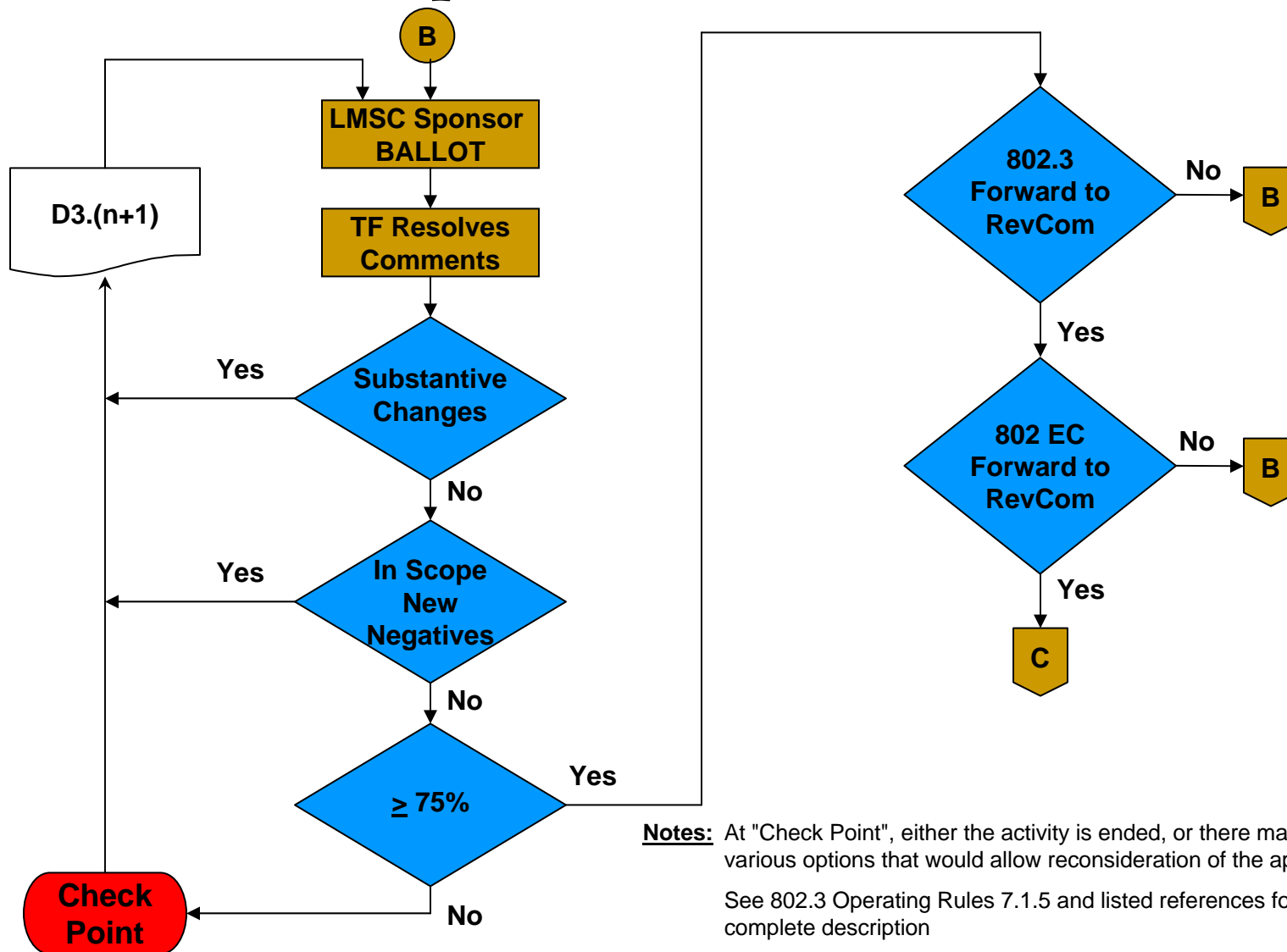

Overview of IEEE 802.3 Standards Process (5/5)

Final Approvals and Standard Release

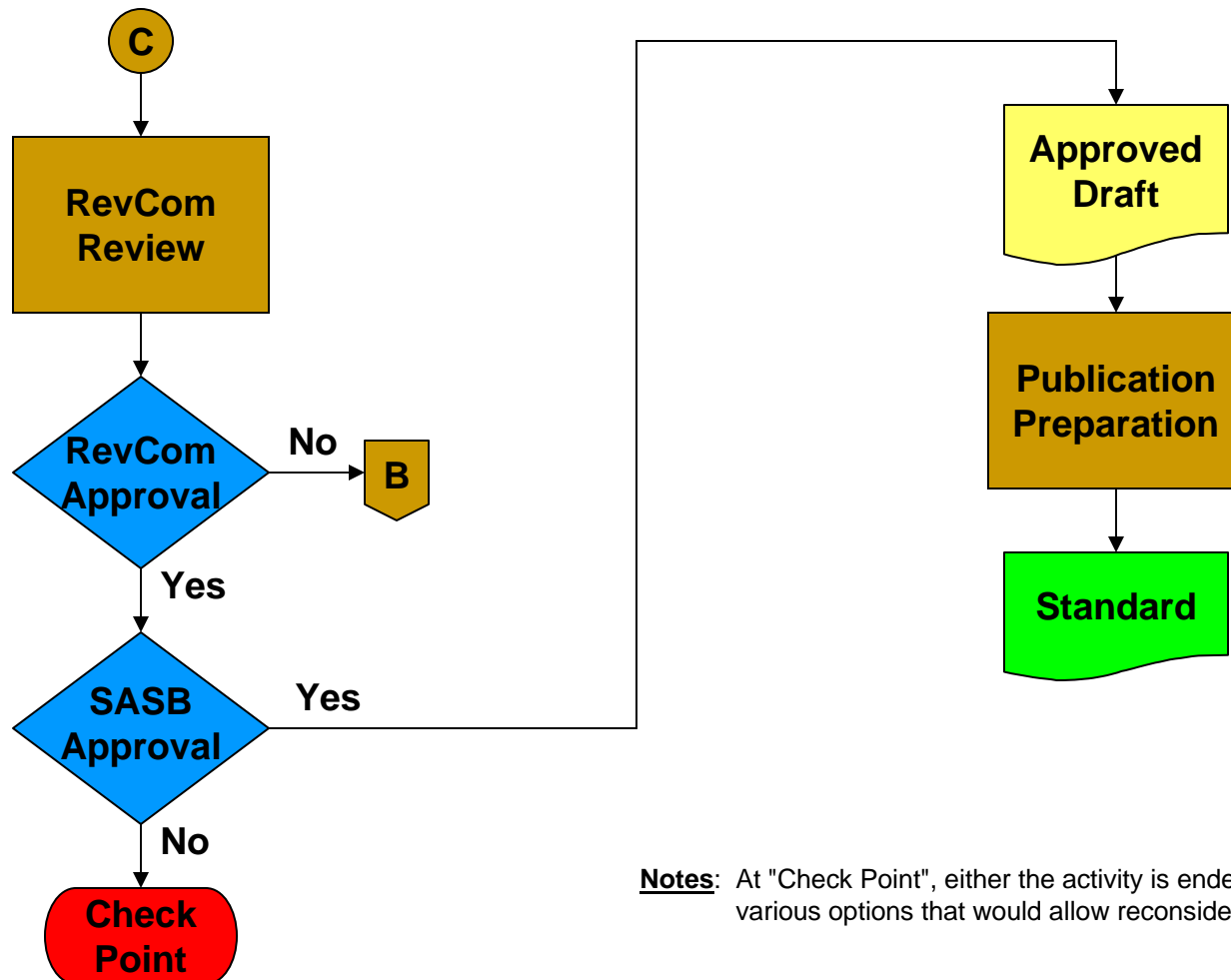

Notes: At "Check Point", either the activity is ended, or there may be various options that would allow reconsideration of the approval.

IEEE 802.3az Objectives

- Define a mechanism to reduce power consumption during periods of low link utilization for the following PHYs
 - 100BASE-TX (Full Duplex)
 - 1000BASE-T (Full Duplex)
 - 10GBASE-T
 - 10GBASE-KR
 - 10GBASE-KX4

- Define a protocol to coordinate transitions to or from a lower level of power consumption

- The link status should not change as a result of the transition

IEEE 802.3az Objectives

- No frames in transit shall be dropped or corrupted during the transition to and from the lower level of power consumption
- The transition time to and from the lower level of power consumption should be transparent to upper layer protocols and applications
- Define a 10 megabit PHY with a reduced transmit amplitude requirement such that it shall be fully interoperable with legacy 10BASE-T PHY over 100 m of Class D (Category 5) or better cabling to enable reduced power implementations.
- Any new twisted-pair and/or backplane PHY for EEE shall include legacy compatible auto negotiation

A possible 802.3az timeline

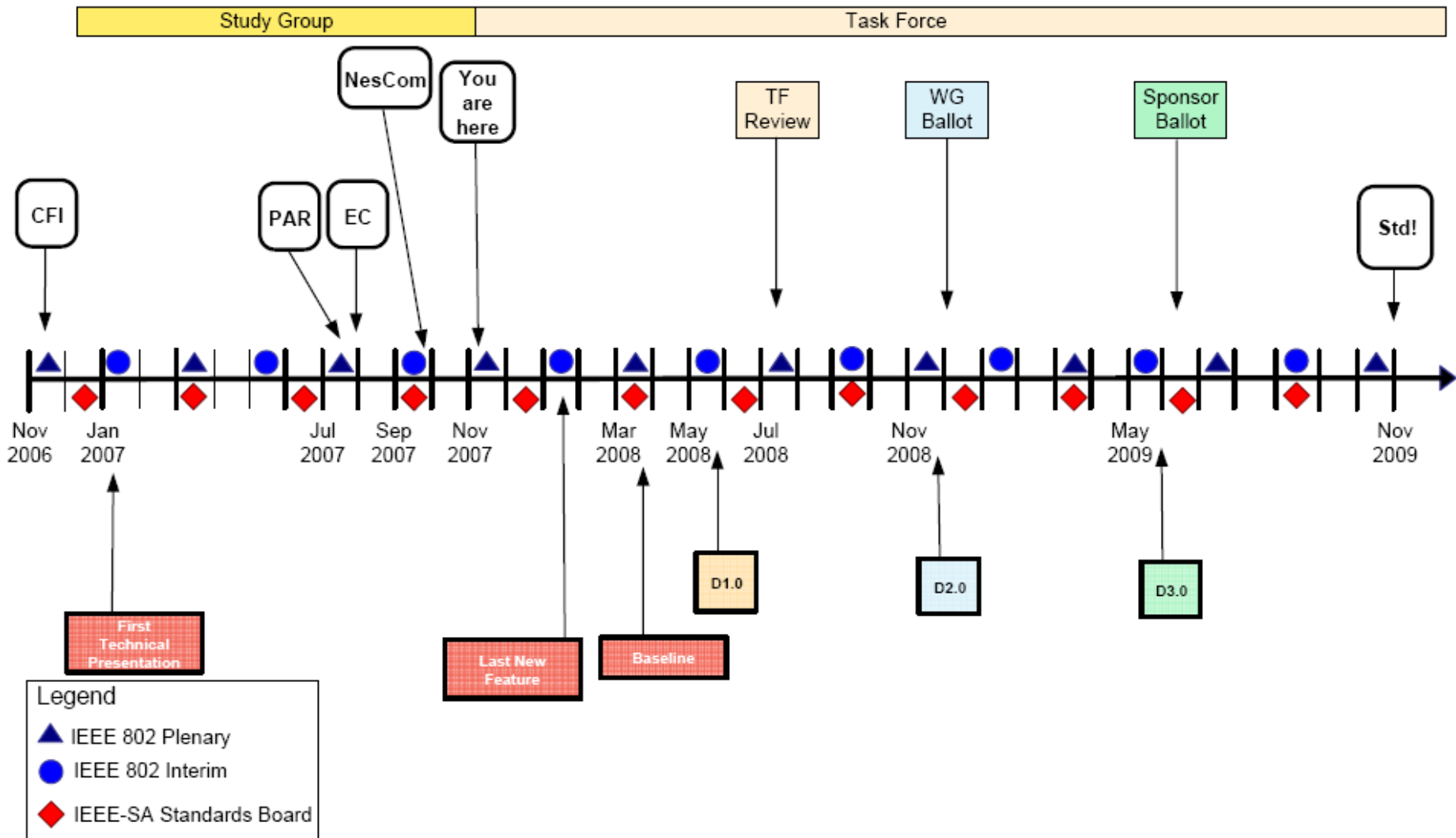

Presentations and Discussion

Tuesday

Time	Title	File name	Presenter	Affiliation	Duration
9:00 AM	Introductions, Agenda and General Information	agenda_1_0108.pdf	Mike Bennett	LBNL	0:20
9:20 AM	Musings on Savings	nordman_01_0108.pdf	Bruce Nordman	LBNL	0:15
9:35 AM	Active/Idle Toggling with Low-Power Idle	hays_01_0108.pdf	Robert Hays	Intel	0:45
10:20 AM	Break				0:20
10:40 AM	Energy Efficient Ethernet Switching Perspective	dove_01_0108.pdf	Dan Dove	ProCurve	0:40
11:20 AM	Reducing network energy consumption via sleeping and rate-adaptation	nedeveschi_01_0108.pdf	Sergiu Nedeveschi	UC Berkeley	0:15
11:35 AM	Proposal of Low-Power Idle 100Base-TX	chou_01_0108.pdf	Joseph Chou	Realtek	0:40
12:15 PM	Lunch				1:30
1:45 PM	1000BASE-T Low-Power Idle	healey_01_0108.pdf	Adam Healey	LSI	0:30
2:15 PM	Feasibility of Asymmetrical Low-Power Idle 1000Base-T	chou_02_0108.pdf	Joseph Chou	Realtek	0:30
2:45 PM	10GBase-T Active / Low-Power Idle Toggling	parnababy_01_0108.pdf	Gavin Parnaby	Solarflare	0:30
3:15 PM	Break				0:30
3:45 PM	Supporting Legacy Devices	booth_01_0108.pdf	Brad Booth	AMCC	0:30
4:15 PM	Transmit Amplitude Reduction "Green-T": The path to a "greener" 10BASE-T	chadha_01_0108.pdf	Mandeep Chadha	Vitesse	0:30
4:45 PM	Recess				

Wednesday

Time	Title	File name	Presenter	Affiliation	Duration
9:00 AM	A "Subset PHY" Approach for Energy Efficient Ethernet	powell_01_0108.pdf	Scott Powell	Broadcom	0:45
9:45 AM	A "Subset PHY" Approach for 10GBASE-KR Energy Efficient Ethernet	baumer_01_0108.pdf	Howard Baumer	Broadcom	0:20
10:05 AM	Break				0:30
10:35 AM	Discussion and motions				1:25
12:00 PM	Lunch				1:30
1:30 PM	Discussion and motions				1:30
3:00 PM	Break				0:30
3:30 PM	Discussion and motions				1:30
5:00 PM	Adjourn				

Future Meetings

- March 2008 Plenary
 - Week of March 16-21
 - Caribe Royale Orlando
 - Orlando, Florida

- May 2008 Interim
 - (Proposed) Week of May 12-16
 - Venue ...
 - Munich, Germany

- Future meeting information at:
 - <http://www.ieee802.org/meeting/index.html>

Thank You!