



IEEE P802.3ba 40Gb/s and 100Gb/s Ethernet

Opening Plenary Report

Orlando, FL, USA
Mar 2010

John D'Ambrosia
jdambrosia@ieee.org



IEEE P802.3ba Task Force Officers and Editors

<u>John D'Ambrosia</u>	Task Force Chair
<u>Ilango Ganga</u>	Task Force Chief Editor Editor – Clauses 1, 4, 80, Annexes A, 4A
<u>Mark Gustlin</u>	Chair, “Logic” Sub-task Force Editor – Clauses 81, 82
<u>Chris DiMinico</u>	Chair, “Cu” Sub-task Force Editor – Clause 85
<u>Pete Anslow</u>	Chair, “Optical” Sub-task Force Editor – Clause 88
<u>Hugh Barrass</u>	Editor – Clauses 30, 45
<u>Jonathan King</u>	Editor – Clause 87
<u>Arthur Marris</u>	Editor – Clauses 69, 73, 74, 84, Annexes 69A, 69B
<u>Steve Trowbridge</u>	Editor – Clause 83, Annex 83C
<u>Ryan Latchman</u>	Editor – Annex 83A, 83B
<u>Piers Dawe</u>	Editor – Clause 86, 52
<u>George Oulundsen</u>	Task Force Secretary
<u>Frank Chang</u>	Task Force Web Master

Reflector and Web

- To subscribe to the IEEE P802.3ba Task Force reflector, send an email to:

ListServ@ieee.org

with the following in the body of the message (do not include “<>”):

***subscribe stds-802-3-hssg <yourfirstname> <yourlastname>
end***

- Send IEEE P802.3ba Task Force reflector messages to:

STDS-802-3-HSSG@listserv.ieee.org

- Task Force web page URL:

http://www.ieee802.org/3/ba/

IEEE P802.3ba Private Area

- URL: <http://www.ieee802.org/3/ba/private/>
 - Username: 802.3ba
 - Password: xxxxxxxx
 - Password is case sensitive

- Note - The draft is posted for your review only, and neither the draft nor access information should be copied or redistributed to others in violation of document copyrights.

Task Force Approved Project Documents

■ PAR

- http://ieee802.org/3/ba/PAR/par_0308.pdf

■ 5 Criteria

http://ieee802.org/3/ba/PAR/P802.3ba_5C_0908.pdf

■ Objectives

- http://ieee802.org/3/ba/PAR/P802.3ba_Objectives_0709.pdf

Activities Summary Since Nov 09 Plenary

- Draft 3.0
 - Conducted Initial Sponsor Ballot
 - Opened Nov 23, 2009
 - Closed Dec 23, 2009
 - 3 1/2 day Interim meeting in New Orleans in Jan (Thanks Applied Micro)
 - 71 Participants
 - Reviewed all T(402), TR (187), E (255), ERs (49), G(7), and GR(1)
 - Jan 10 Motion:
 - Move that the Task Force:
 - Accept comment resolutions from D3.0 as recorded in the comment database.
 - Directs the IEEE P802.3ba editorial team to generate Draft 3.1, based on Draft 3.0 and the resolution of comments against Draft 3.0.
 - Request Working Group Chair to initiate Sponsor Ballot recirculation.
 - Results (y/n/a): 55 / 0 / 0
- Jan 10 : ITU-T Informal Communication
 - Shared Draft 3.1
- Jan 10: IBTA Informal Communication
 - Shared contributions that provided updated data on QSFP and CXP connector interfaces
- Draft 3.1
 - Conducted 1st recirculation on Sponsor ballot
 - Opened Feb 12, 2010
 - Closed Feb 27, 2010

IEEE P802.3ba Task Force Timeline

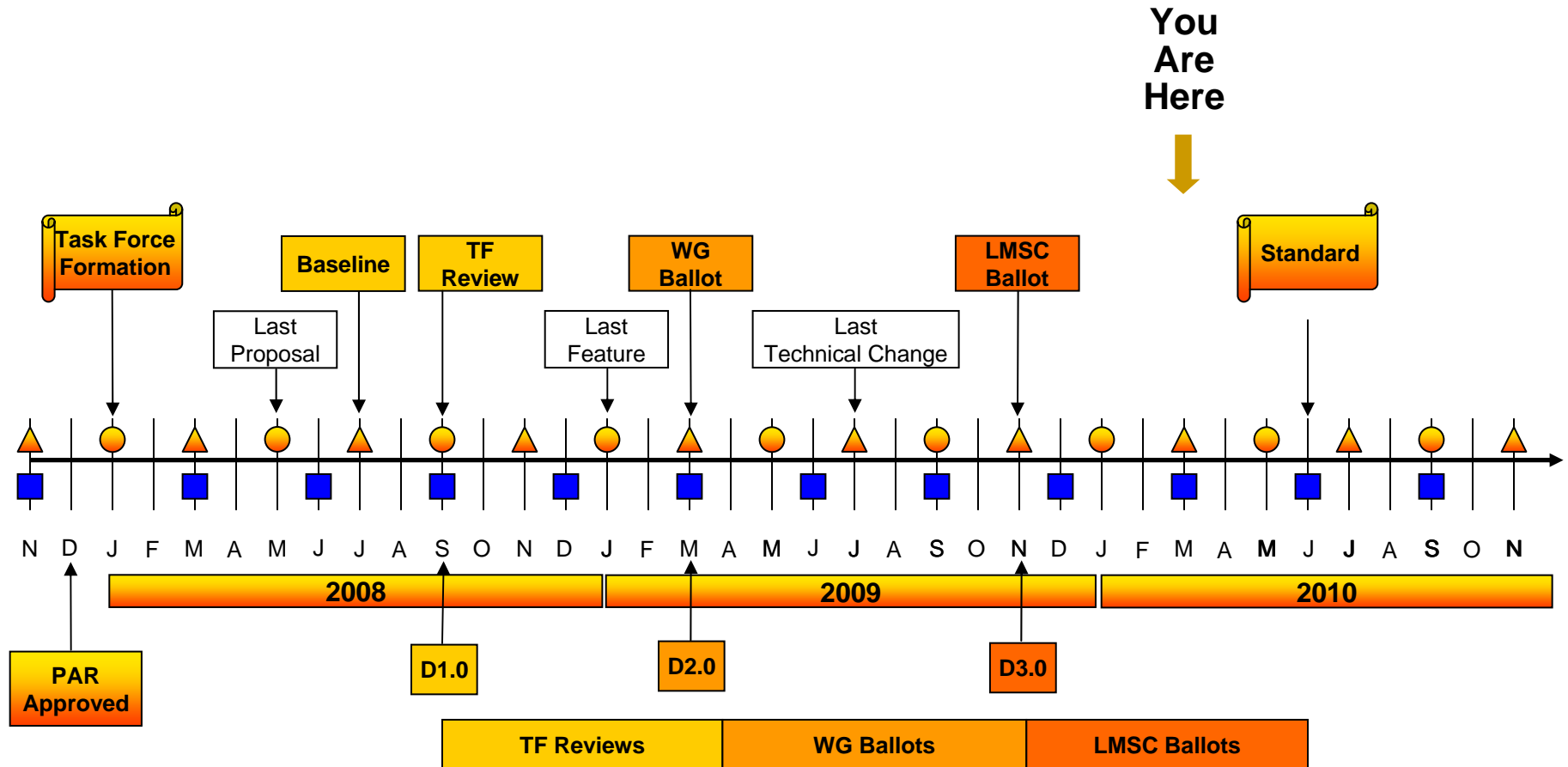

You Are Here



* Adopted by IEEE P802.3ba TF at March 08 Plenary

Legend	
▲	IEEE 802 Plenary
●	IEEE 802.3 Interim
■	IEEE-SA Standards Board

Sponsor ballot results

	D3.0 Initial Sponsor ballot	D3.1 First Sponsor ballot recirc
Voters	143	143
Approve	89	97
Disapprove	21	17
Disapprove w/o comment	0	0
Abstain	6	6
Returns	116	120
Response rate	81%	83%
Abstention rate	5%	5%
Approval rate	80%	85%

Ballot met required response rate $\geq 75\%$, abstention rate $< 30\%$, and approval rate $\geq 75\%$

Approval rate history

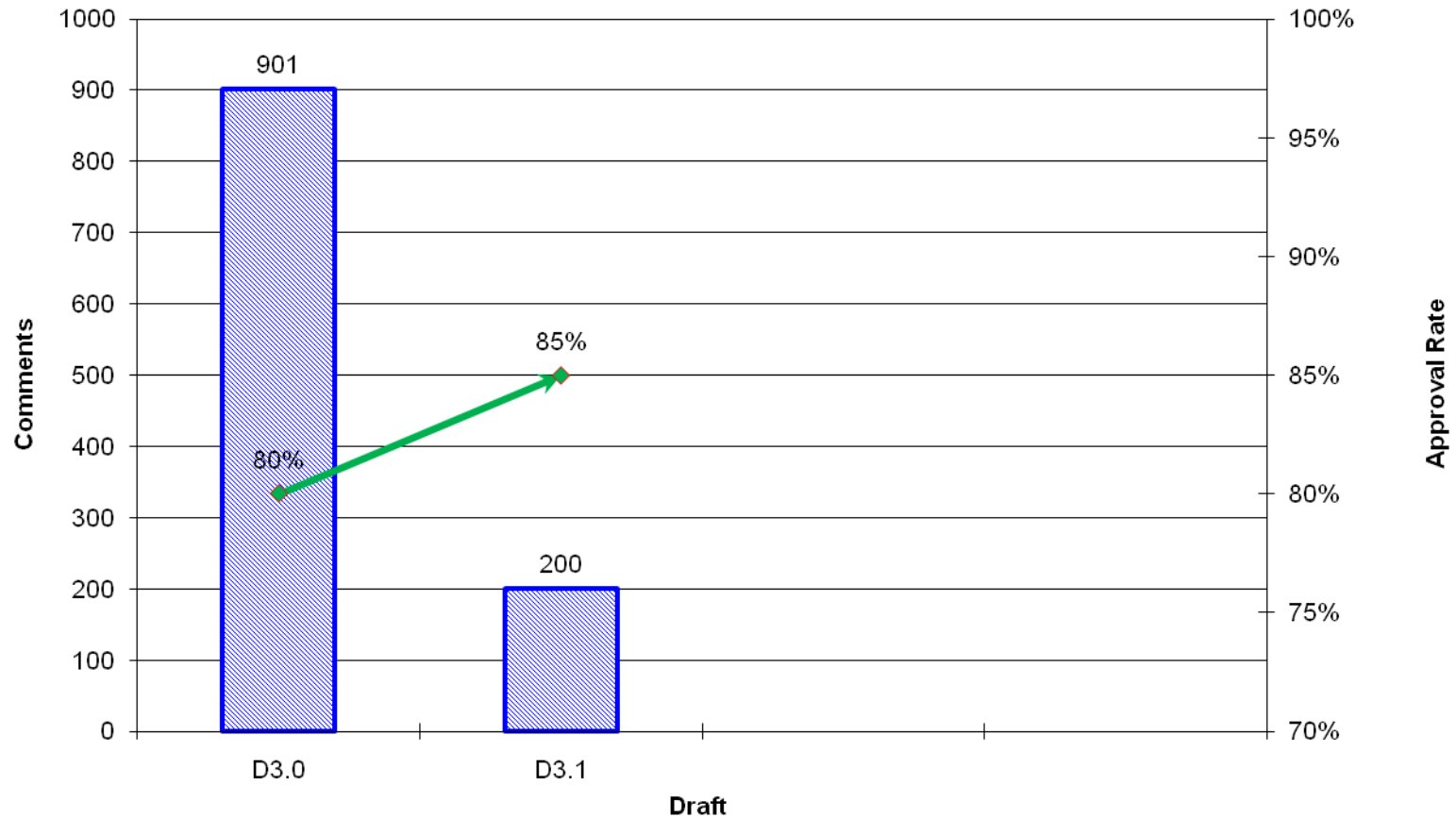

Comments history

P802.3ba Sponsor ballot comment history

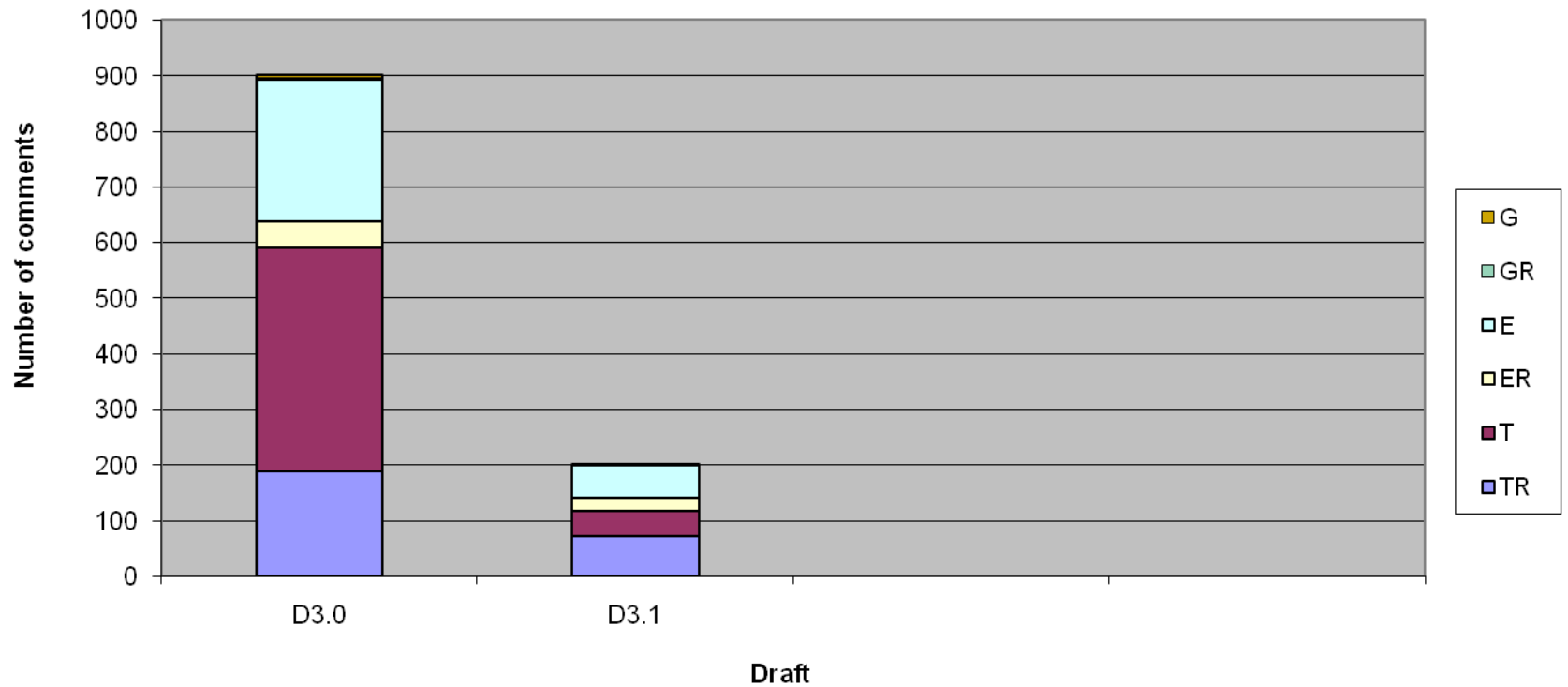

D3.0 Comments

Description	Editor	Clause	TR	T	ER	E	GR	G	Total
Front matter, MAC, 40G & 100G Intro	Ilango Ganga	99, 00, 01, A, 4, 4A, 31B, 80	8	19	5	20	1	2	55
Management	Hugh Barrass	30, 45	15	67	4	33	0	2	121
RS/MII and PCS	Mark Gustlin	81, 82	14	89	3	37	0	0	143
PMA	Steve Trowbridge	83, 83C	6	35	1	16	0	0	58
XLAUI/CAUI	Ryan Latchman	83A, 83B	22	35	17	33	0	1	108
Backplane KR4 related	Arthur Marris	69, 69A, 69B, 73, 74, 84	7	27	2	28	0	0	64
Copper CR4 & CR10	Chris Di Minico	85, 85A	52	70	13	60	0	0	195
Optical SR4 & SR10, and Cls. 52	Piers Dawe	86, 86A, 52	37	39	4	15	0	2	97
Optical 40G LR4	Jonathan King	87	13	14	0	9	0	0	36
Optical 100G LR4 & ER4	Pete Anslow	88	13	7	0	4	0	0	24
Total comments			187	402	49	255	1	7	901

D3.0 Comments distribution by category

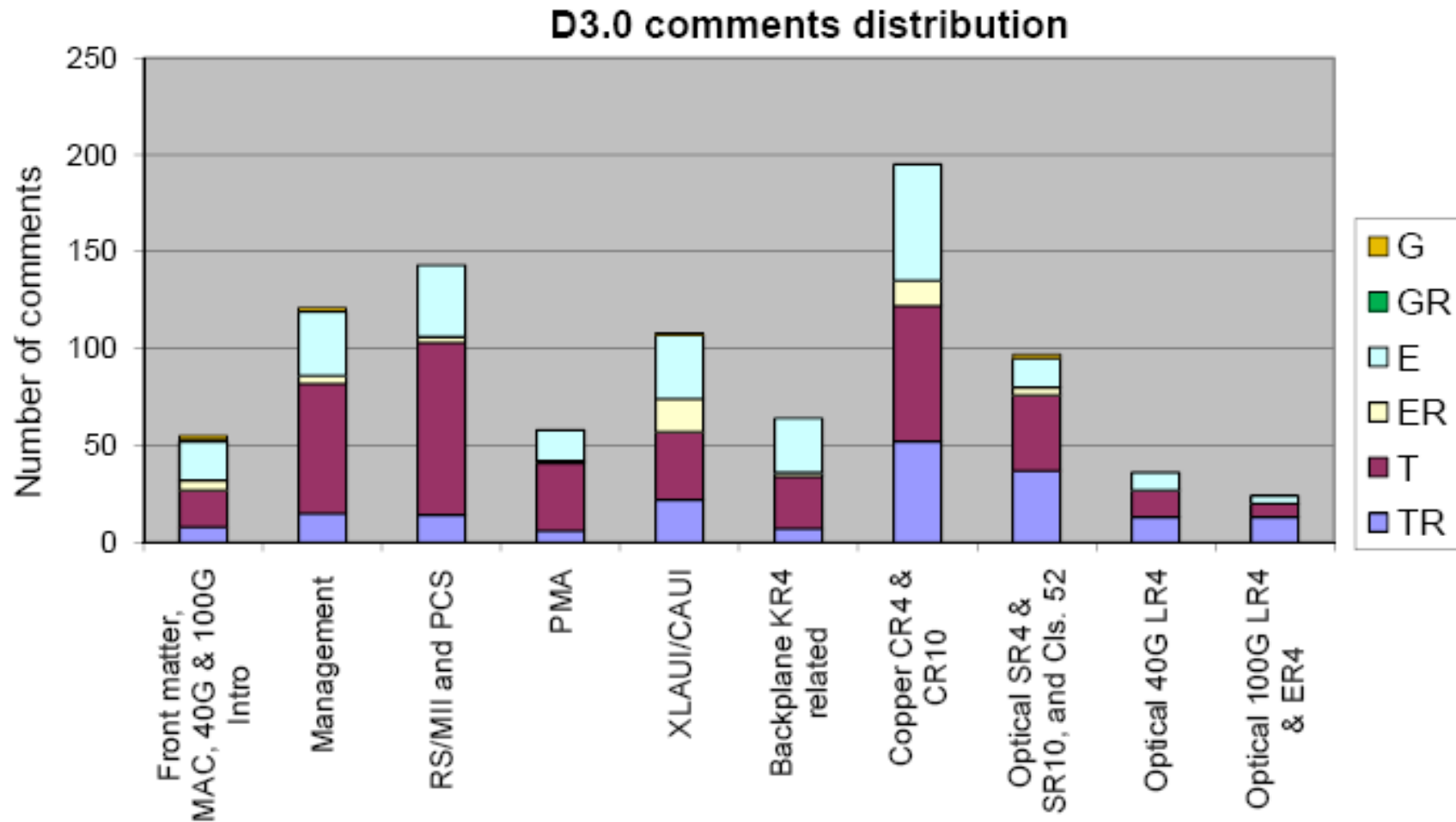

D3.1 Comments report

Description	Editor	Clause	TR	T	ER	E	GR	G	Total
Front matter, MAC, 40G & 100G Intro Management	Ilango Ganga	99, 00, 01, A, 4, 4A, 31B, 80	1	5	3	5	0	0	14
RS/MII and PCS	Hugh Barrass	30, 45	1	8	1	12	0	0	22
PMA	Mark Gustlin	81, 82	4	4	0	5	0	0	13
XLAUI/CAUI	Steve Trowbridge	83, 83C	0	2	0	1	0	0	3
Backplane KR4 related	Ryan Latchman	83A, 83B	37	10	8	11	0	0	66
Copper CR4 & CR10	Arthur Marris	69, 69A, 69B, 73, 74, 84	3	4	4	6	0	0	17
Optical SR4 & SR10, and Cls. 52	Chris Di Minico	85, 85A	9	4	4	13	0	0	30
Optical 40G LR4	Piers Dawe	86, 86A, 52	11	8	2	6	1	0	28
Optical 100G LR4 & ER4	Jonathan King	87	5	1	1	0	0	0	7
Total comments	Pete Anslow	88	0	0	0	0	0	0	0
			71	46	23	59	1	0	200

D3.1 Comments distribution by category

D3.1 comment distribution

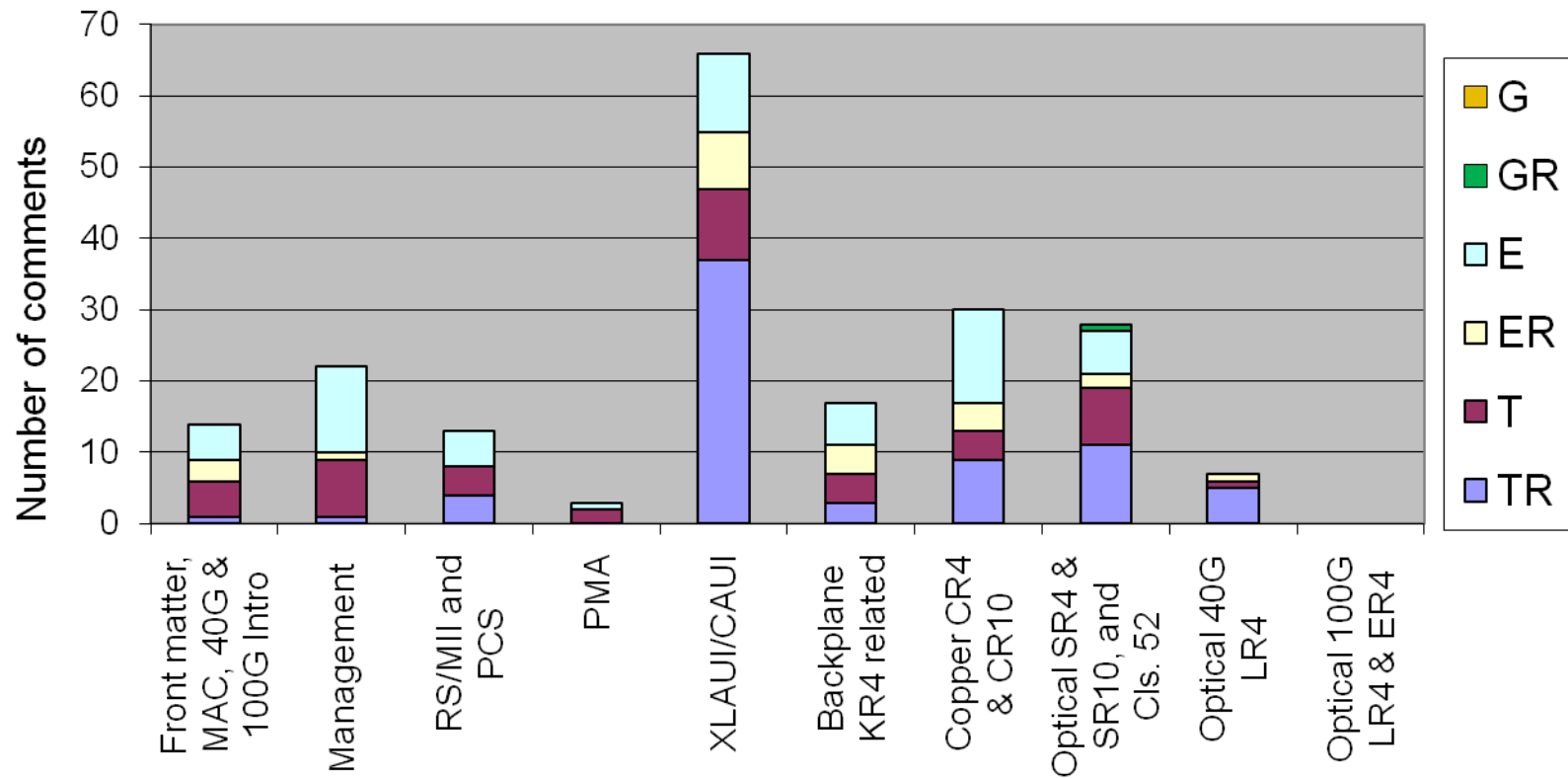

Unresolved comments history

P802.3ba WG ballot unresolved comments history

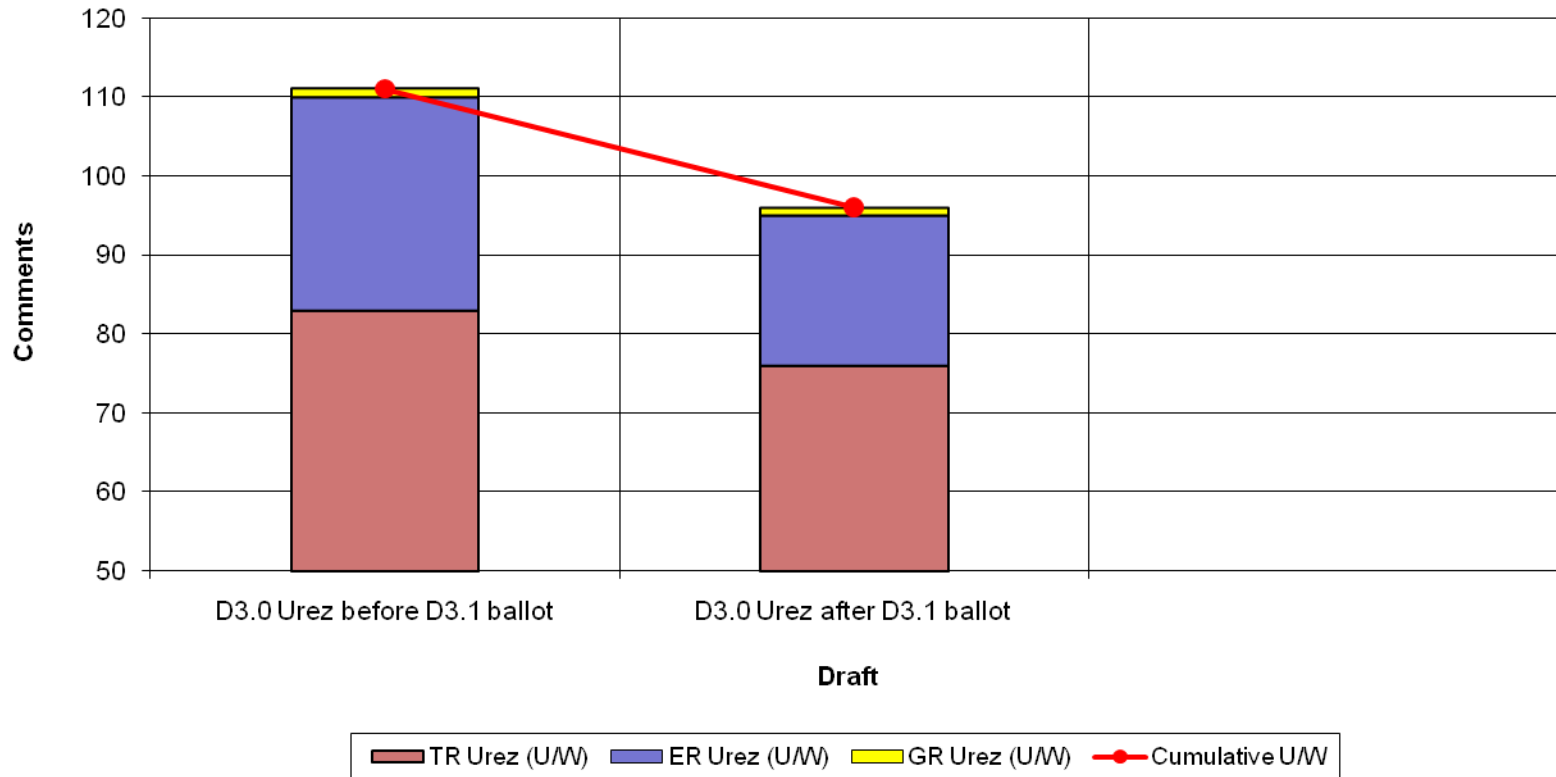

Goals for the Week

■ Big Ticket Items

- ❑ Resolve comments received against D3.1
- ❑ Proceed to State of “STOP MAKING CHANGES”
- ❑ Lay groundwork for the next meeting - Draft 3.2
- ❑ Request Conditional Approval to submit to RevCom at closing IEEE 802.3 WG Plenary.

Meeting Map

	Mon	Tues	Wed	Thur	Fri		
8:30		Task Force	Logic	Copper	Optics	Task Force Motions & Closing Business	
9:00							
9:30							
10:00							
10:30							
11:00							
11:30							
12:00	Lunch	Lunch	Lunch		Lunch		
12:30							
13:00	802.3 Plenary	Task Force	Logic	Copper	Optics	802.3 Plenary	
13:30							
14:00							
14:30							
15:00							
15:30							
16:00		Logic	Copper	Optics		SEC	
16:30							
17:00							
17:30							
18:00		Dinner					
18:30	Tutorial #1		Social				
19:00		IEEE 802 30th Anniversary Celebration - Panel Discussion					
19:30	Tutorial #2						
20:00							
20:30							
21:00							
21:30	CFI						
22:00							

Note –Times listed are subject to change. See individual sub-task force agendas for sub-task force meeting details.



Thank You!

