



IEEE P802.3ba 40Gb/s and 100Gb/s Ethernet Task Force

Agenda and General Information

Chicago, IL
September, 2009



Agenda

- Welcome and Introductions
- Approve Agenda
- Approve the Minutes
- Goals for this Week
- Ground Rules
- Reflector and Web
- IEEE
 - Structure
 - Bylaws and Rules
 - Call for Patents
 - IEEE Standards Process
- Opening Reports (Chief Editor, Sub-Task Force Chairs)
- Comment Resolution D2.2
- Motions & Closing Business
- Future Meetings

Task Force Decorum



- Press (i.e., anyone reporting publicly on this meeting) are to announce their presence (2007 SASB Op Manual 5.3.3.5)
- Photography or recording by permission only (5.3.3.4)
- Cell phone ringers off
- Wear your badges at all times in meeting areas

Goals for the Week

- Progress Towards Sponsor Ballot
 - Respond to comments against IEEE P802.3ba Draft 2.2
- Lay groundwork for the next meeting
 - Draft 2.3
- Big Ticket Items
 - Preparation to go to Sponsor Ballot
 - Closure on Clause 85
 - Syncing up Clause 85 and 86

IEEE P802.3ba Task Force Officers and Editors

<u>John D'Ambrosia</u>	Task Force Chair
<u>Ilango Ganga</u>	Task Force Chief Editor Editor – Clauses 1, 4, 80, Annexes A, 4A
<u>Mark Gustlin</u>	Chair, “Logic” Sub-task Force Editor – Clauses 81, 82
<u>Chris DiMinico</u>	Chair, “Cu” Sub-task Force Editor – Clause 85
<u>Pete Anslow</u>	Chair, “Optical” Sub-task Force Editor – Clause 88
<u>Hugh Barrass</u>	Editor – Clauses 30, 45
<u>Jonathan King</u>	Editor – Clause 87
<u>Arthur Marris</u>	Editor – Clauses 69, 73, 74, 84, Annexes 69A, 69B
<u>Steve Trowbridge</u>	Editor – Clause 83, Annex 83C
<u>Ryan Latchman</u>	Editor – Annex 83A, 83B
<u>Piers Dawe</u>	Editor – Clause 86, 52
<u>George Oulundsen</u>	Task Force Secretary
<u>Frank Chang</u>	Task Force Web Master

Ground Rules

- Based upon IEEE 802.3 Rules
 - Foundation based upon Robert's Rules of Order
 - Anyone in the room may speak
 - Anyone in the room may vote
- **RESPECT**... give it, get it
- NO product pitches
- NO corporate pitches
- NO prices!!!
 - This includes costs, ASPs, etc. no matter what the currency
- NO restrictive notices

Reflector and Web

- To subscribe to the IEEE P802.3ba Task Force reflector, send an email to:

ListServ@ieee.org

with the following in the body of the message (do not include “<>”):

***subscribe stds-802-3-hssg <yourfirstname> <yourlastname>
end***

- Send IEEE P802.3ba Task Force reflector messages to:

STDS-802-3-HSSG@listserv.ieee.org

- Task Force web page URL:

http://www.ieee802.org/3/ba/

IEEE P802.3ba Private Area

- URL: <http://www.ieee802.org/3/ba/private/>
 - Username: 802.3ba
 - Password: xxxxxxx

- Write it down...

- Note - The draft is posted for your review only, and neither the draft nor access information should be copied or redistributed to others in violation of document copyrights.

Task Force Approved Project Documents

■ PAR

- http://ieee802.org/3/ba/PAR/par_0308.pdf

■ 5 Criteria

- http://ieee802.org/3/ba/PAR/P802.3ba_5C_0908.pdf

■ Objectives

- http://ieee802.org/3/ba/PAR/P802.3ba_Objectives_0709.pdf

IEEE Structure

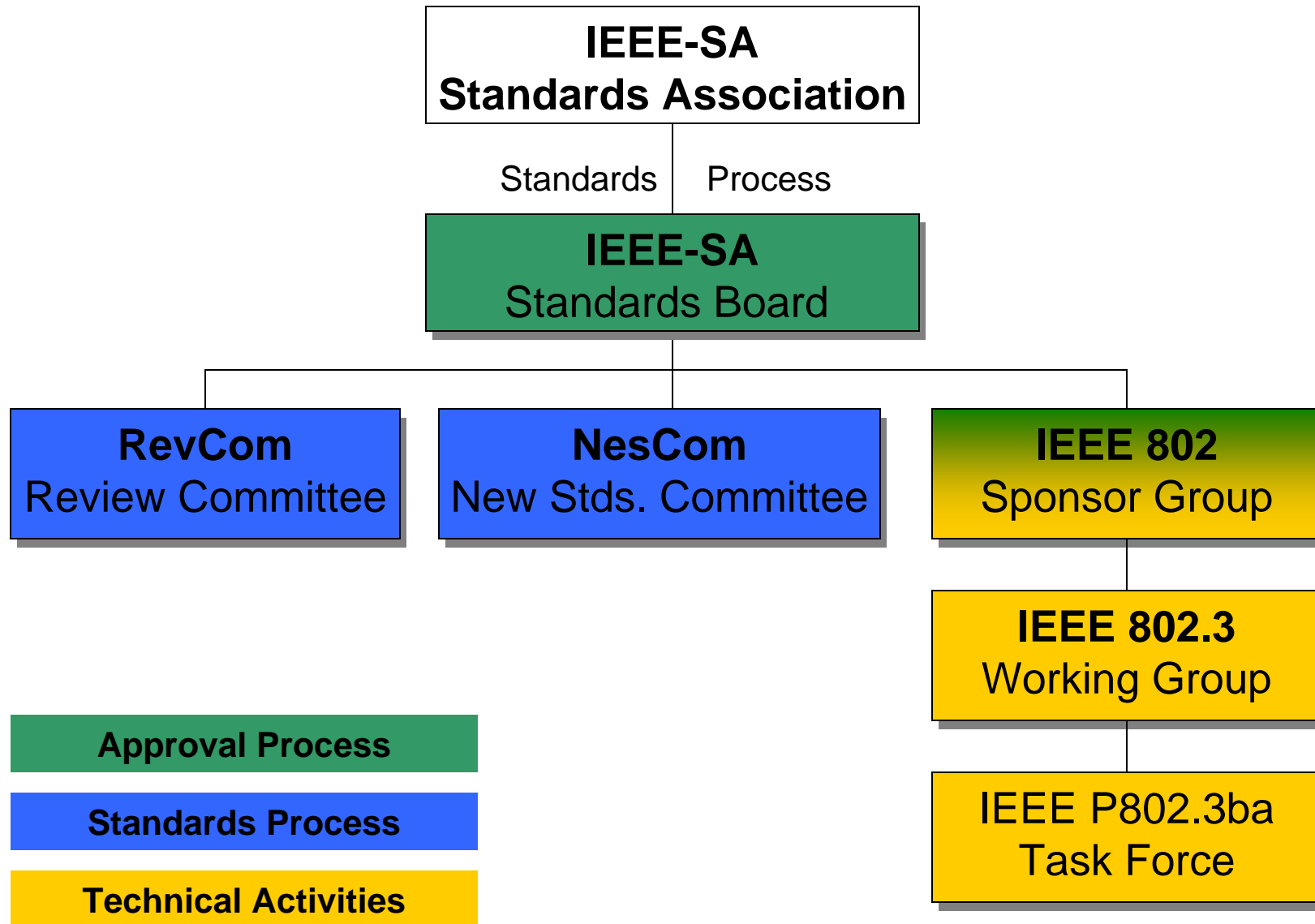

Bylaws and Rules

- **IEEE-SA Operations Manual:**
 - <http://standards.ieee.org/sa/sa-om.pdf>
- **IEEE-SA Standards Board Bylaws:**
 - <http://standards.ieee.org/guides/bylaws/sb-bylaws.pdf>
- **IEEE-SA Standards Board Operations Manual:**
 - <http://standards.ieee.org/guides/opman/sb-om.pdf>
- **IEEE 802 LAN/MAN Standards Committee (LMSC) Policies and Procedures:**
 - http://standards.ieee.org/board/aud/LMSC_2009.pdf
- **IEEE 802 LAN/MAN Standards Committee (LMSC) Operations Manual:**
 - http://www.ieee802.org/PNP/2008-11/LMSC_OM_approved_081114.pdf
- **IEEE 802.3 Working Group Operating Rules:**
 - http://ieee802.org/3/rules/P802_3_rules.pdf

Participants, Patents, and Duty to Inform

All participants in this meeting have certain obligations under the IEEE-SA Patent Policy. Participants:

- “Shall inform the IEEE (or cause the IEEE to be informed)” of the identity of each “holder of any potential Essential Patent Claims of which they are personally aware” if the claims are owned or controlled by the participant or the entity the participant is from, employed by, or otherwise represents
 - “Personal awareness” means that the participant “is personally aware that the holder may have a potential Essential Patent Claim,” even if the participant is not personally aware of the specific patents or patent claims
- “Should inform the IEEE (or cause the IEEE to be informed)” of the identity of “any other holders of such potential Essential Patent Claims” (that is, third parties that are not affiliated with the participant, with the participant’s employer, or with anyone else that the participant is from or otherwise represents)
- The above does not apply if the patent claim is already the subject of an Accepted Letter of Assurance that applies to the proposed standard(s) under consideration by this group

Quoted text excerpted from IEEE-SA Standards Board Bylaws subclause 6.2

- Early identification of holders of potential Essential Patent Claims is strongly encouraged
- No duty to perform a patent search

Patent Related Links

All participants should be familiar with their obligations under the IEEE-SA Policies & Procedures for standards development.

Patent Policy is stated in these sources:

IEEE-SA Standards Boards Bylaws

<http://standards.ieee.org/guides/bylaws/sect6-7.html#6>

IEEE-SA Standards Board Operations Manual

<http://standards.ieee.org/guides/opman/sect6.html#6.3>

Material about the patent policy is available at

<http://standards.ieee.org/board/pat/pat-material.html>

If you have questions, contact the IEEE-SA Standards Board Patent Committee Administrator at patcom@ieee.org or visit <http://standards.ieee.org/board/pat/index.html>

This slide set is available at <http://standards.ieee.org/board/pat/pat-slideset.ppt>

Call for Potentially Essential Patents

- If anyone in this meeting is personally aware of the holder of any patent claims that are potentially essential to implementation of the proposed standard(s) under consideration by this group and that are not already the subject of an Accepted Letter of Assurance:
 - Either speak up now or
 - Provide the chair of this group with the identity of the holder(s) of any and all such claims as soon as possible or
 - Cause an LOA to be submitted

Other Guidelines for IEEE WG Meetings

- **All IEEE-SA standards meetings shall be conducted in compliance with all applicable laws, including antitrust and competition laws.**
 - **Don't discuss the interpretation, validity, or essentiality of patents/patent claims.**
 - **Don't discuss specific license rates, terms, or conditions.**
 - Relative costs, including licensing costs of essential patent claims, of different technical approaches may be discussed in standards development meetings.
 - Technical considerations remain primary focus
 - **Don't discuss or engage in the fixing of product prices, allocation of customers, or division of sales markets.**
 - **Don't discuss the status or substance of ongoing or threatened litigation.**
 - **Don't be silent if inappropriate topics are discussed ... do formally object.**

See *IEEE-SA Standards Board Operations Manual*, clause 5.3.10 and "Promoting Competition and Innovation: What You Need to Know about the IEEE Standards Association's Antitrust and Competition Policy" for more details.

Overview of IEEE 802.3 Standards Process (1/5)- Study Group Phase

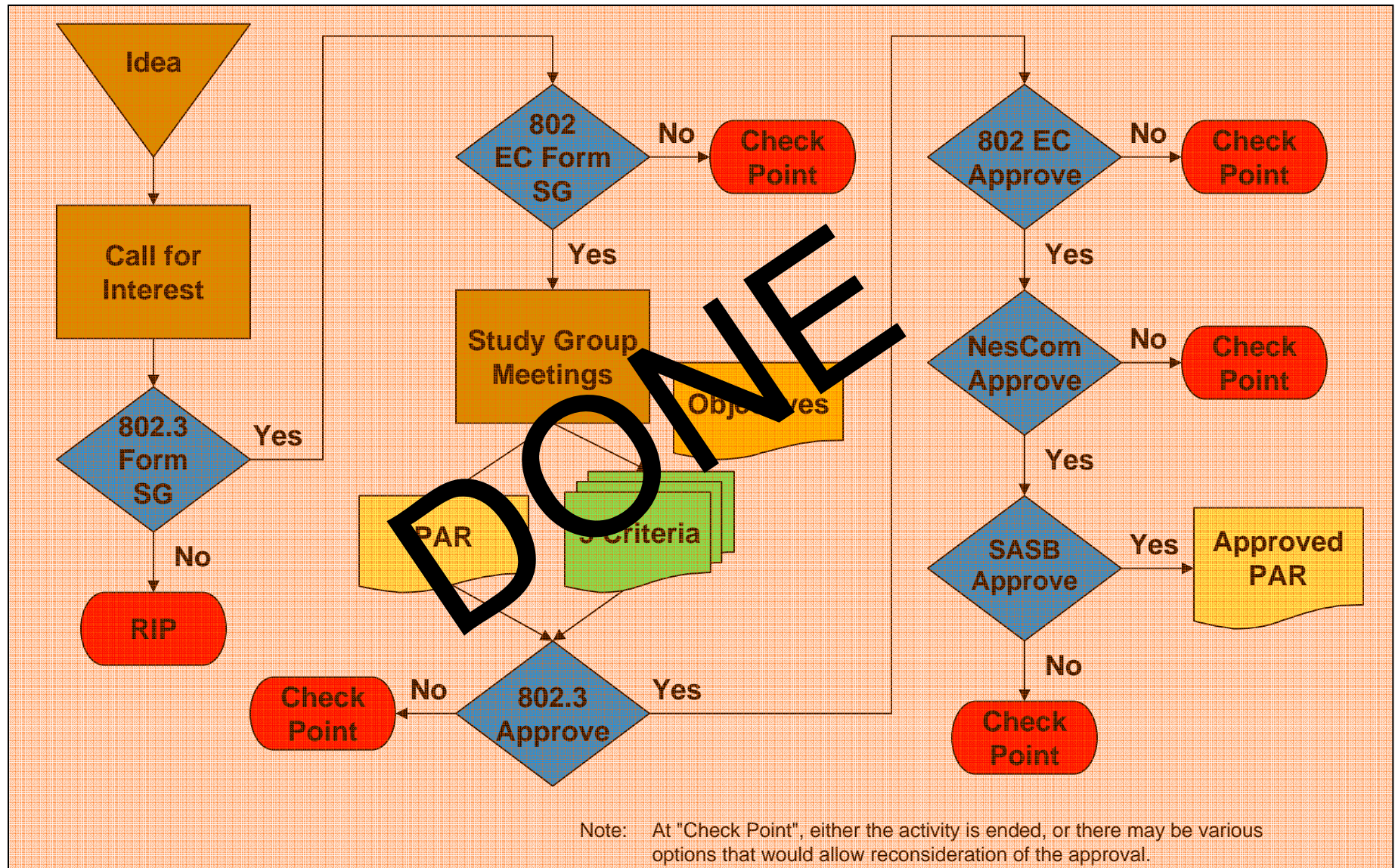

Overview of IEEE 802.3 Standards Process (2/5) - Task Force Comment Phase

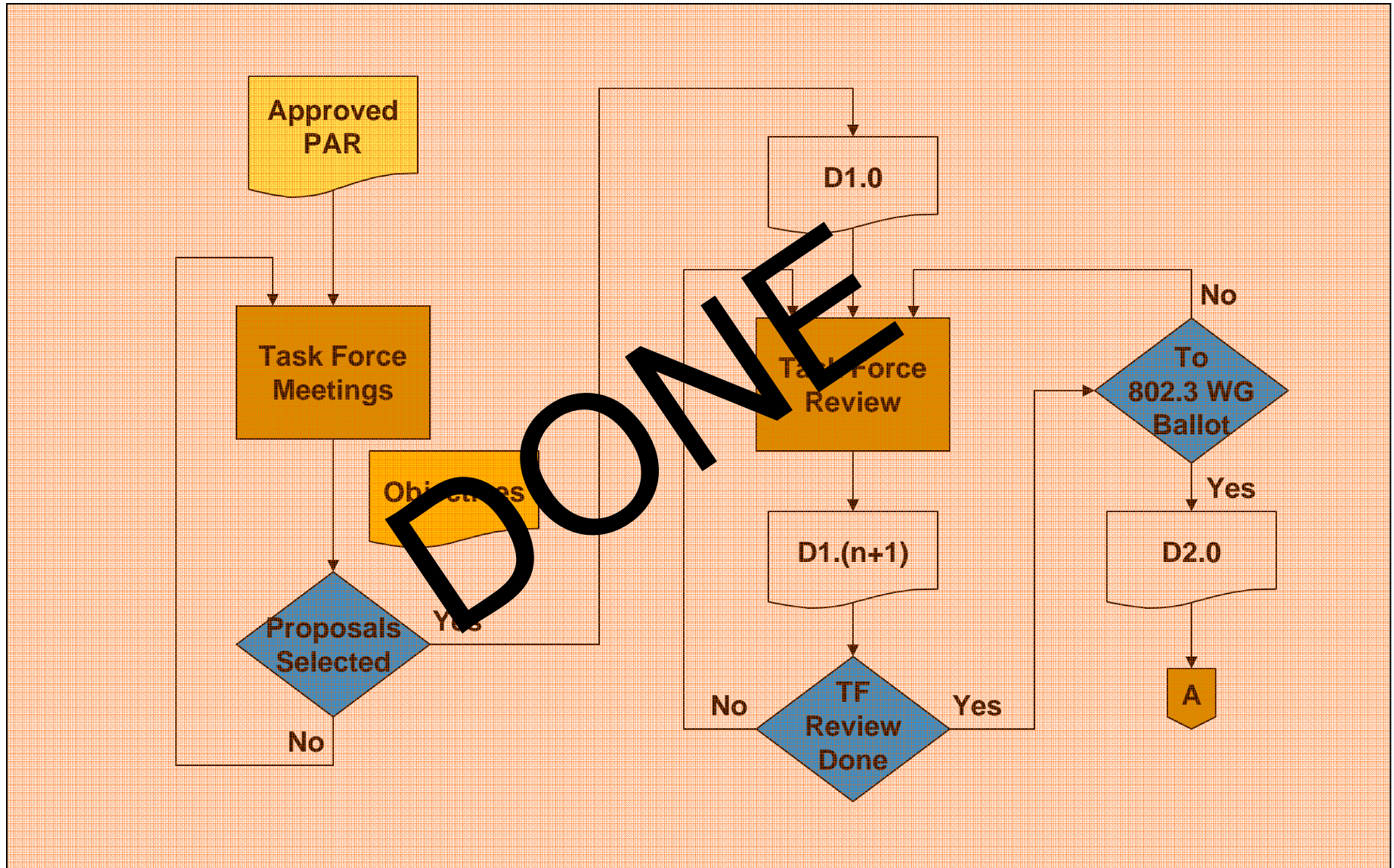

Overview of IEEE 802.3 Standards Process (3/5) - Working Group Ballot Phase

WE ARE HERE

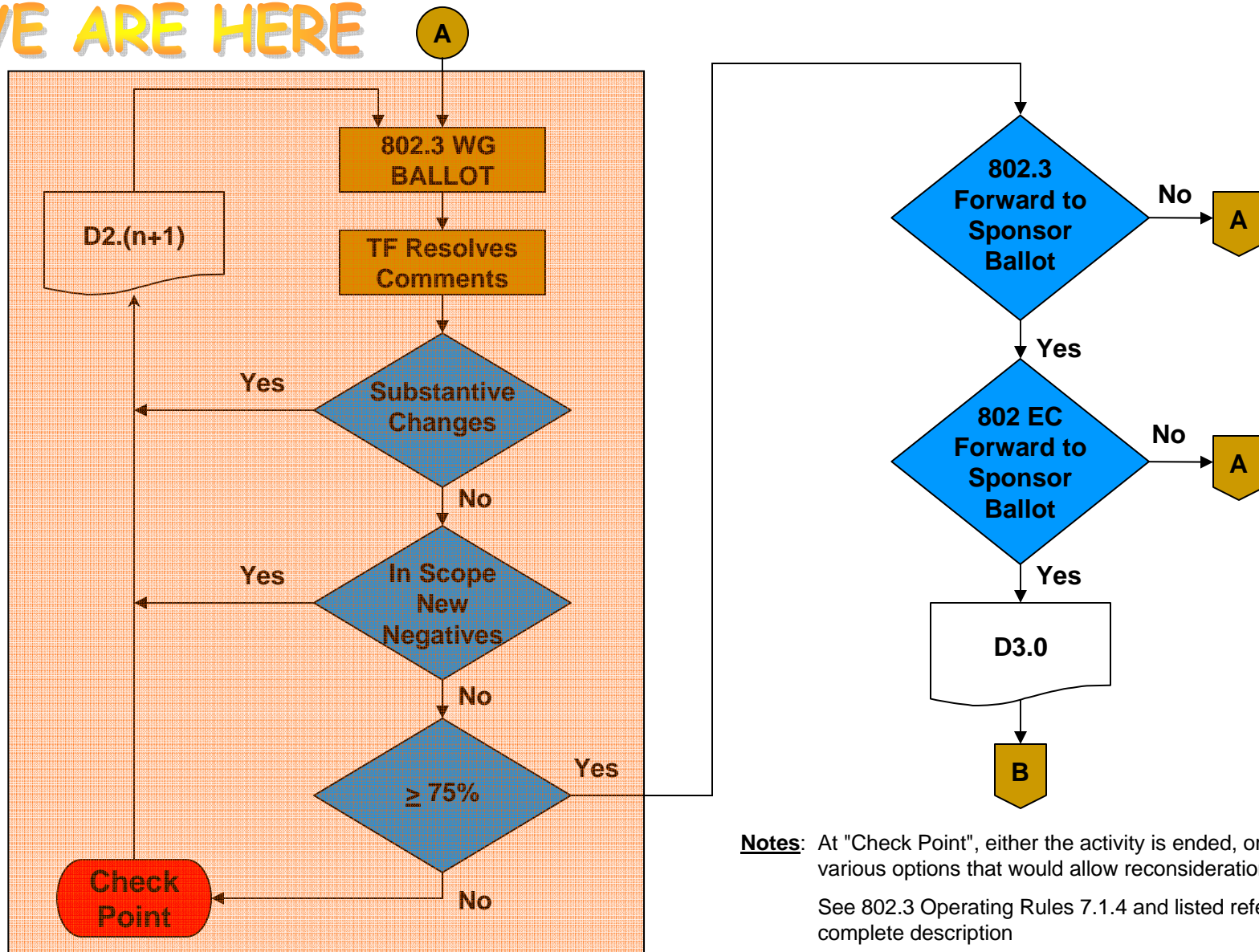

Notes: At "Check Point", either the activity is ended, or there may be various options that would allow reconsideration of the approval. See 802.3 Operating Rules 7.1.4 and listed references for complete description

Overview of IEEE 802.3 Standards Process (4/5)- Sponsor Ballot Phase

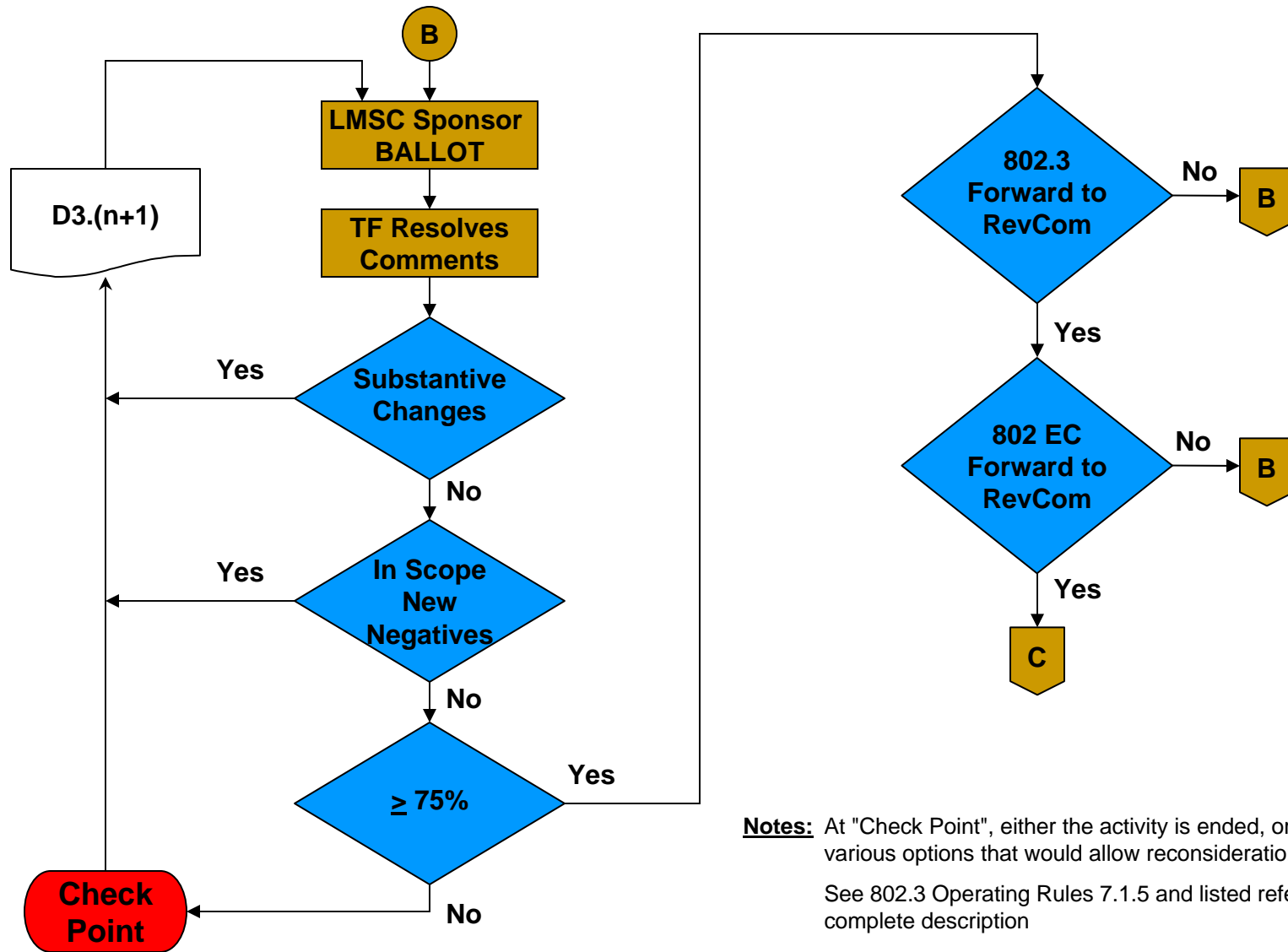

Notes: At "Check Point", either the activity is ended, or there may be various options that would allow reconsideration of the approval. See 802.3 Operating Rules 7.1.5 and listed references for complete description

Overview of IEEE 802.3 Standards Process (5/5) - Final Approvals / Standard Release

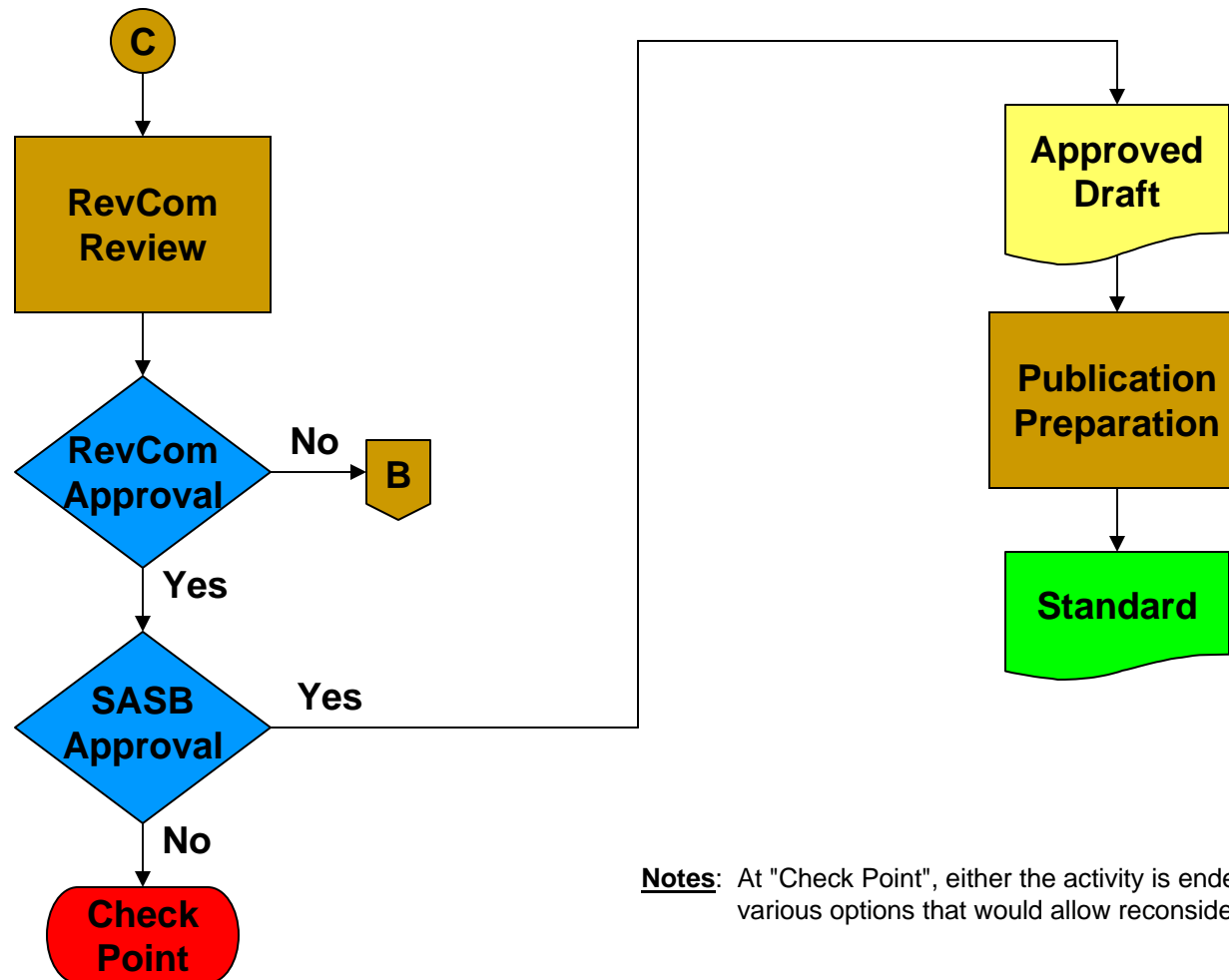

Notes: At "Check Point", either the activity is ended, or there may be various options that would allow reconsideration of the approval.

IEEE P802.3ba Task Force Timeline

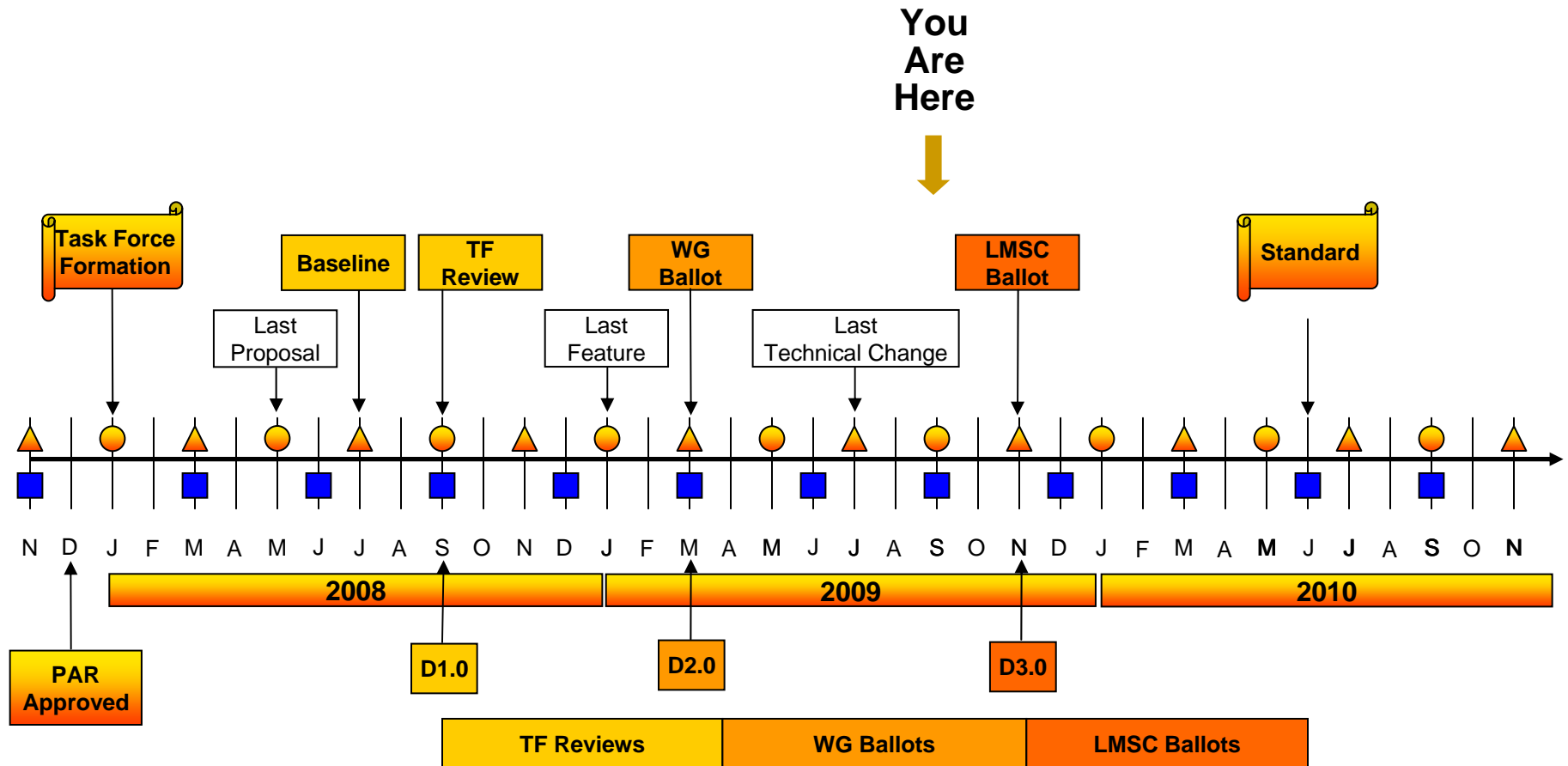

* Adopted by IEEE P802.3ba TF at March 08 Plenary

Sponsor Ballot – Some Links of Interest

- Requirements for Voting -
<http://www.ieee802.org/3/rules/member.html>

Meeting Map

	Mon	Tues	Wed	Thurs	
9:00					
9:30					
10:00	Task Force	Logic	Copper	Optics	
10:30					
11:00					
11:30					
12:00					
12:00	Lunch			Lunch	
12:30	Lunch			Lunch	
13:00	Task Force	Logic	Copper	Optics	Task Force: Closing Reports, Motions, & Closing Business
13:30					
14:00					
14:30					
15:00					
15:30	Task Force	Logic	Copper	Optics	
16:00					
16:30					
17:00					
17:30					
18:00	Dinner			Dinner	
18:30	Dinner			Dinner	
19:00	Dinner			Dinner	
19:30		Logic	Copper	Optics	
20:00					
20:30					
20:30					

Note –Times listed are subject to change. See individual sub-task force agendas for sub-task force meeting details.

Monday 21-Sep-09

Time	Presenter	Affiliation	Title	File Name
9:00 AM	John D'Ambrosia	Force10 Networks	Agenda and General Information	agenda_01_0909.pdf
9:40 AM	Ilango Ganga	Intel	Chief Editor's Opening Report	ganga_01_0909.pdf
10:10 AM	Mark Gustlin	Cisco	Logic SubTask Force - Opening Report	gustlin_01_0909.pdf
10:20 AM	Chris DiMinico	MC Communications	Cu SubTask Force - Opening Report	diminico_01_0909.pdf
10:30 AM			Break	
10:50 AM	Pete Anslow	Nortel	Optical SubTask Force - Opening Report	anslow_01_0909.pdf
11:00 AM			Task Force Comment Resolution	anslow_04_0109.pdf
12:00 PM			Lunch	
1:15 PM			Task Force Comment Resolution (Cu STF time permitting)	
3:00 PM			Break	
3:20 PM			Task Force Comment Resolution (Cu STF time permitting)	
6:00 PM			Break for the Day	

Thursday 24-Sep-09

Time	Presenter	Affiliation	Title	File Name
9:00 AM			Task Force	
10:30 AM			Break	
10:45 AM			Task Force	
12:00 PM			Lunch	
1:00 PM	John D'Ambrosia	Force10 Networks	Opening Comments	
1:15 PM	Mark Gustlin	Cisco	Logic Sub Task Force - Closing Report	gustlin_03_0909.pdf
1:30 PM	Chris DiMinico	MC Communications	Cu SubTask Force - Closing Report	diminico_03_0909.pdf
1:45 PM	Pete Anslow	Nortel	Optical SubTask Force - Closing Report	anslow_03_0909.pdf
2:00 PM	Ilango Ganga	Intel	Chief Editor's Closing Report	ganga_02_0909.pdf
2:15 PM			Discussion, Motions, & Closing Business	
3:00 PM			Adjourn	

Note – Order of presentations and times listed are subject to change.

Future Meetings

- Future Meeting information at:
 - <http://ieee802.org/3/interims/index.html>
- Nov 2009 IEEE 802 Plenary
 - Nov 15 – 20
 - Hyatt Regency Atlanta
 - Atlanta, GA, USA
- Jan 2010 IEEE 802.3 Interim
 - To be announced
- March 2010 IEEE 802 Plenary
 - March 14 - 19
 - Caribe Royale Orlando All Suites Resort and Convention Center
 - Orlando, FL, USA



Thank You!

