

# Alignment marker scrambling for PAM4

Pete Anslow, Ciena

IEEE P802.3bj, Minneapolis, May 2012

# Contributors

Matt Brown, AppliedMicro

# Introduction

The presentation [brown\\_01a\\_0312](#) from the Hawaii meeting had on slide 9:

- Alignment markers are scrambled as well. Need AM mapping to PAM4 to be balanced, randomized, and clock rich.
  - May be able to re-map AM's so that scrambling is not required. Analysis required.
  - Ideally, re-mapping would be common to NRZ and PAM4.

This presentation takes an initial look at the properties of the re-mapped AM section of the PAM4 symbol stream to see if scrambling is required.

# Assumptions

The assumptions used in the PAM4 analysis contained in this presentation were:

- Transcoding: 256B/257B as per NRZ in [gustlin 01 0312](#)
- PAM4 framing as per proposal in [brown 01 0512](#)
- FEC frame 20 x 257 bit blocks + 300 bits of FEC parity
  - FEC parity bits, AM BIP bits and PMA header bits modelled as random
- FEC frame striped to the 4 lanes 10 bits at a time.
- PMA frame 40 header bits, then stripes from 23 FEC frames
- PAM4 termination symbols formed by inserting 0 after every 45 bits
- Precoder as [brown 01a 0312](#)
  - $\{10,11,01,00\}$  map to  $\{3,2,1,0\}$  at input
  - Termination symbols pass through unchanged
  - $\{3,2,1,0\}$  map to  $\{+1,+1/3,-1/3,-1\}$  at output
- Rapid alignment marker parameters as per [anslow 01a 0112](#)

# Baseline wander

Previous NRZ contributions have used a “baseline wander” parameter

This was defined as:

Baseline Wander is the instantaneous offset (in %) in the signal generated by AC coupling at the bit rate / 10,000.

This analysis re-uses this definition unmodified, but it should be noted that for PAM4, the eye height is 1/3 that of NRZ so the effects of a given amount of baseline wander will be greater.

For NRZ contributions see:

P802.3ba [anslow\\_01\\_0108](#)

P802.3ba [anslow\\_06\\_1108](#)

P802.3bj [anslow\\_01a\\_0112](#)

# Clock content

Previous NRZ contributions have also used a “clock content” parameter

This was defined as:

Create a function which is a 1 for a transition and a 0 for no transition and then filter the resulting sequence with a corner frequency of baud/1667.

This analysis also re-uses this definition unmodified but defines a transition as the two adjacent PAM4 symbols being different from each other and taking no account of the magnitude of the difference.

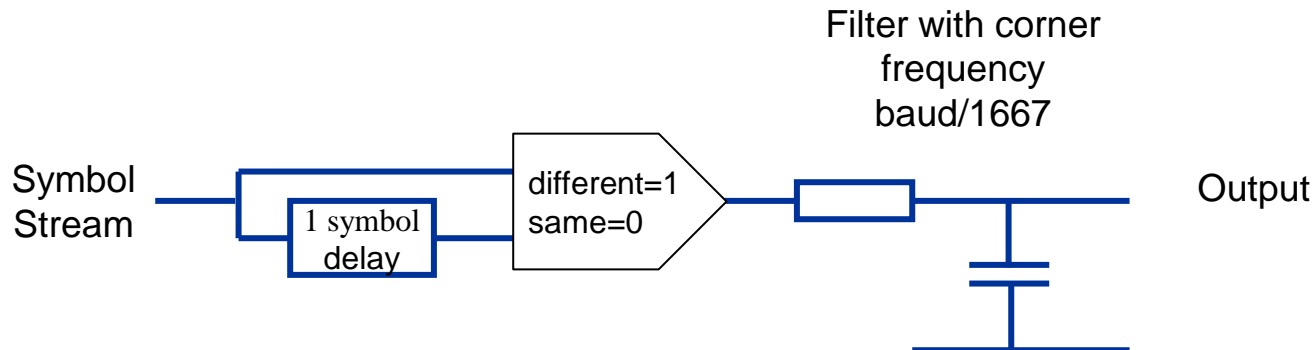

# Baseline wander of AM section

Looking at the baseline wander of the AM section of the 4 lanes gives:

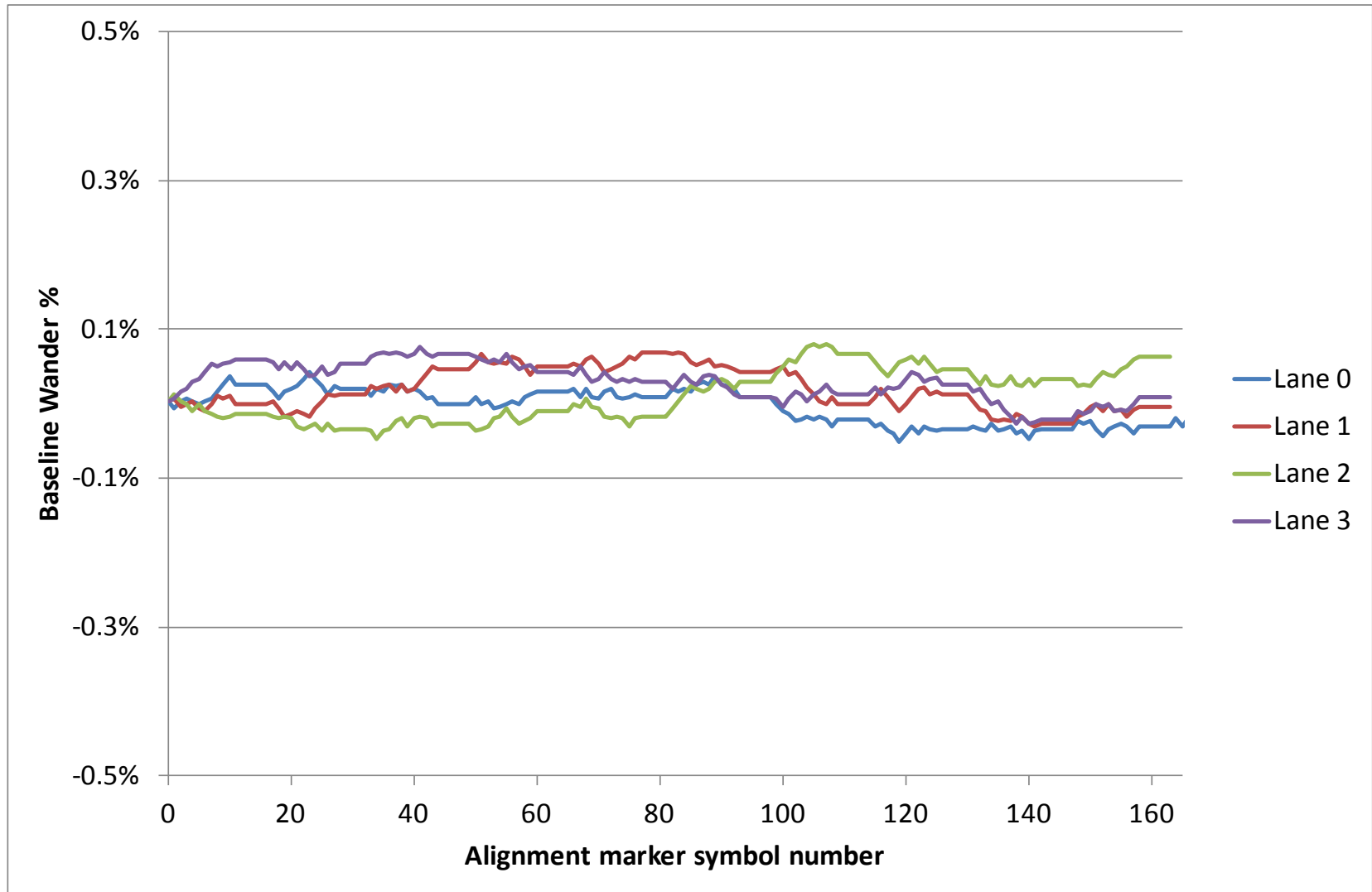

# Clock content of AM section

Looking at the clock content of the AM section of the 4 lanes gives:

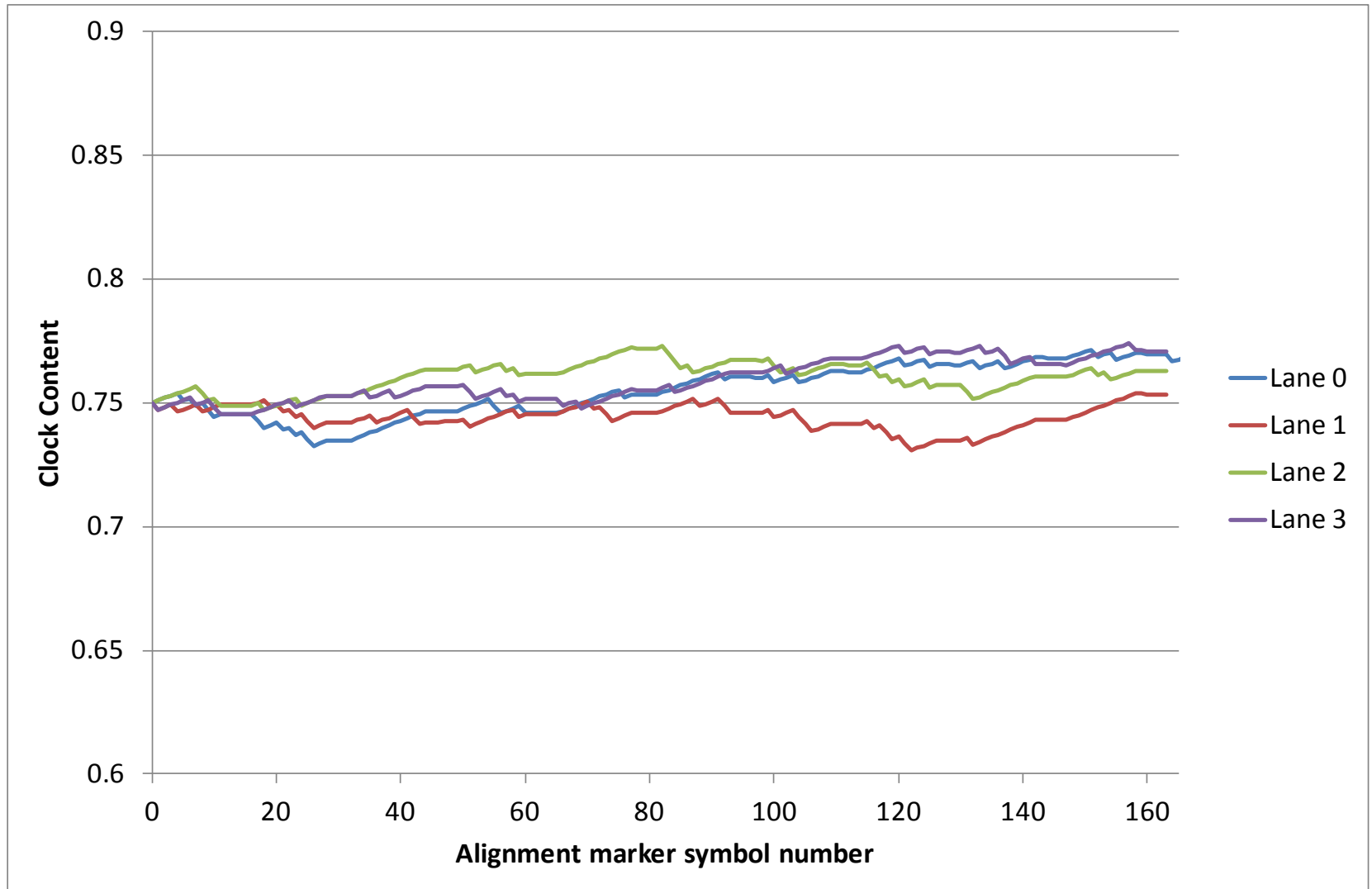



# Distribution of invariant symbols within AMs

	Lane 0	Lane 1	Lane 2	Lane 3
1	32	31	29	30
1/3	25	25	25	26
-1/3	34	33	29	32
-1	26	28	34	29

Poisson distribution

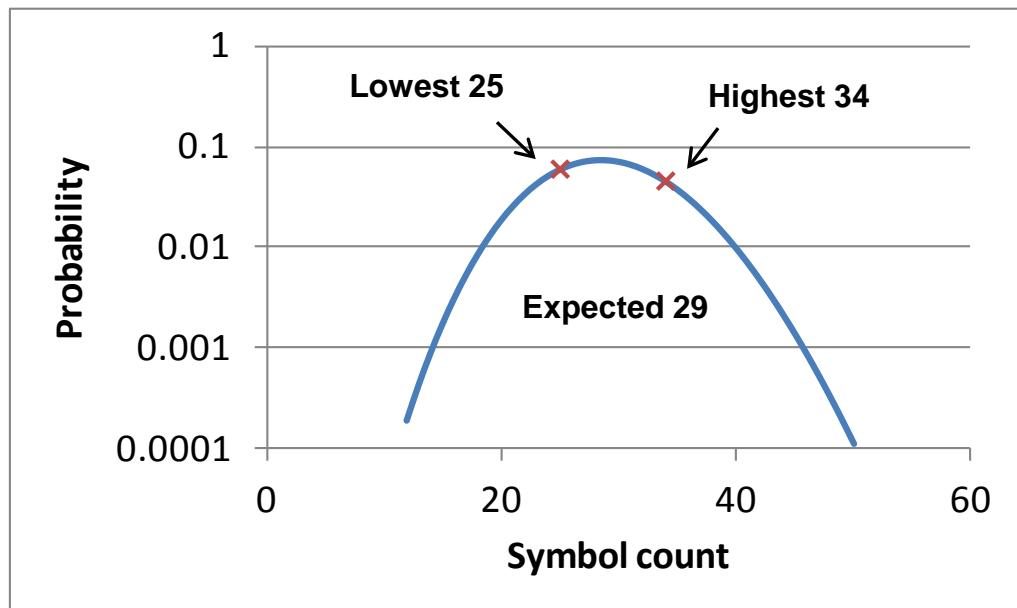

# Idle baseline wander PDFs

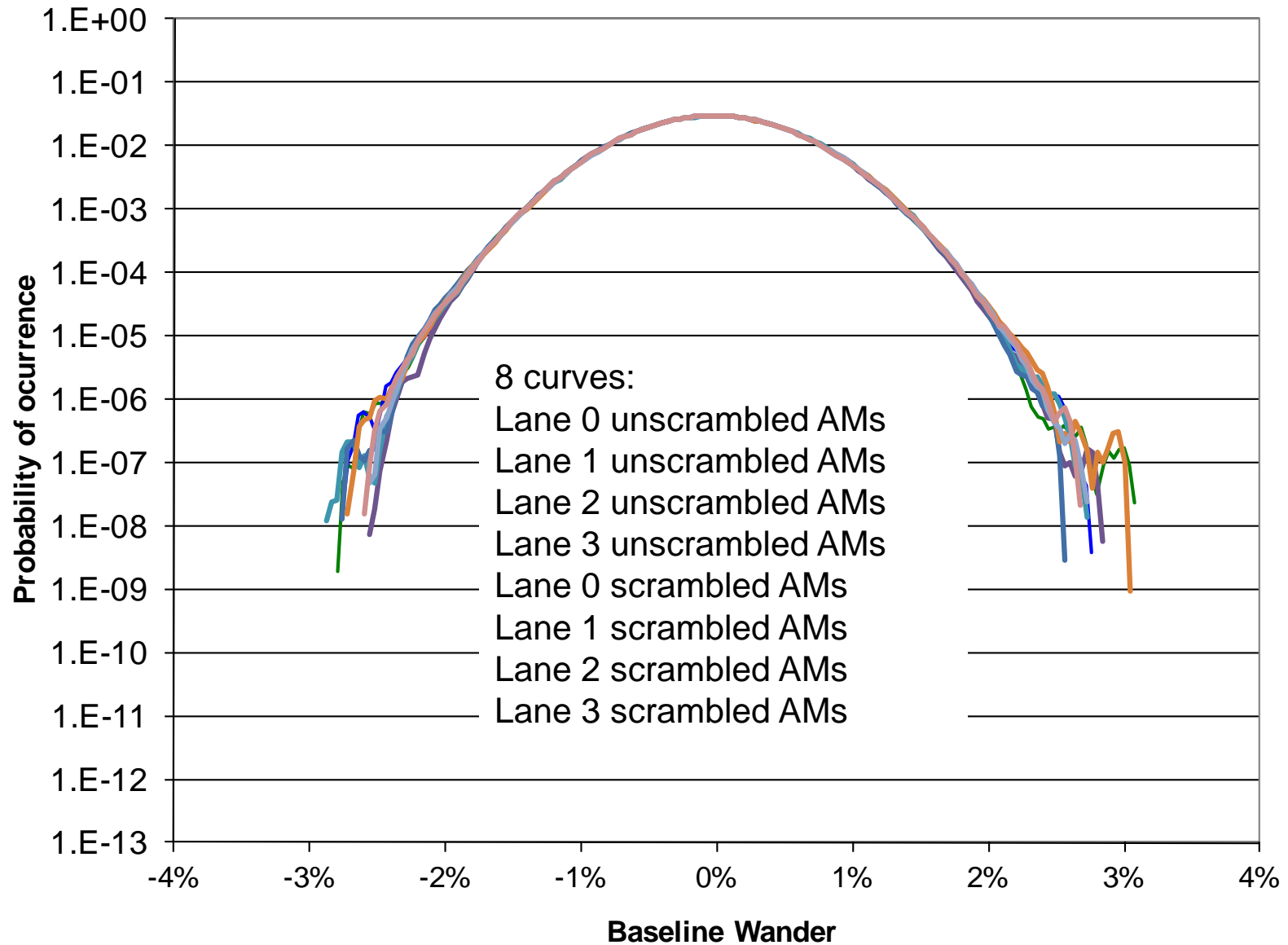

# Idle clock content PDFs

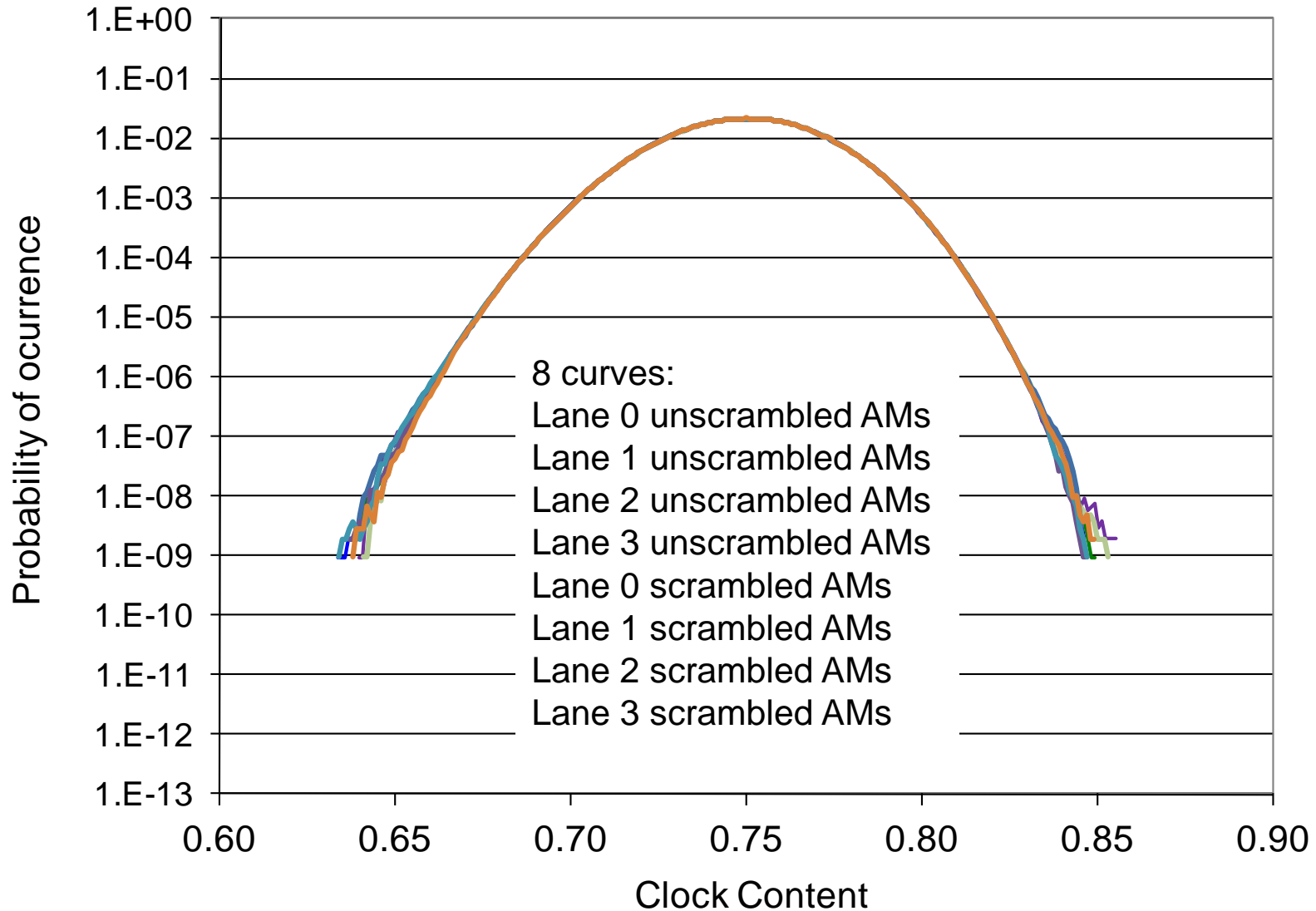

# Idle baseline wander PDFs with rapid AMs

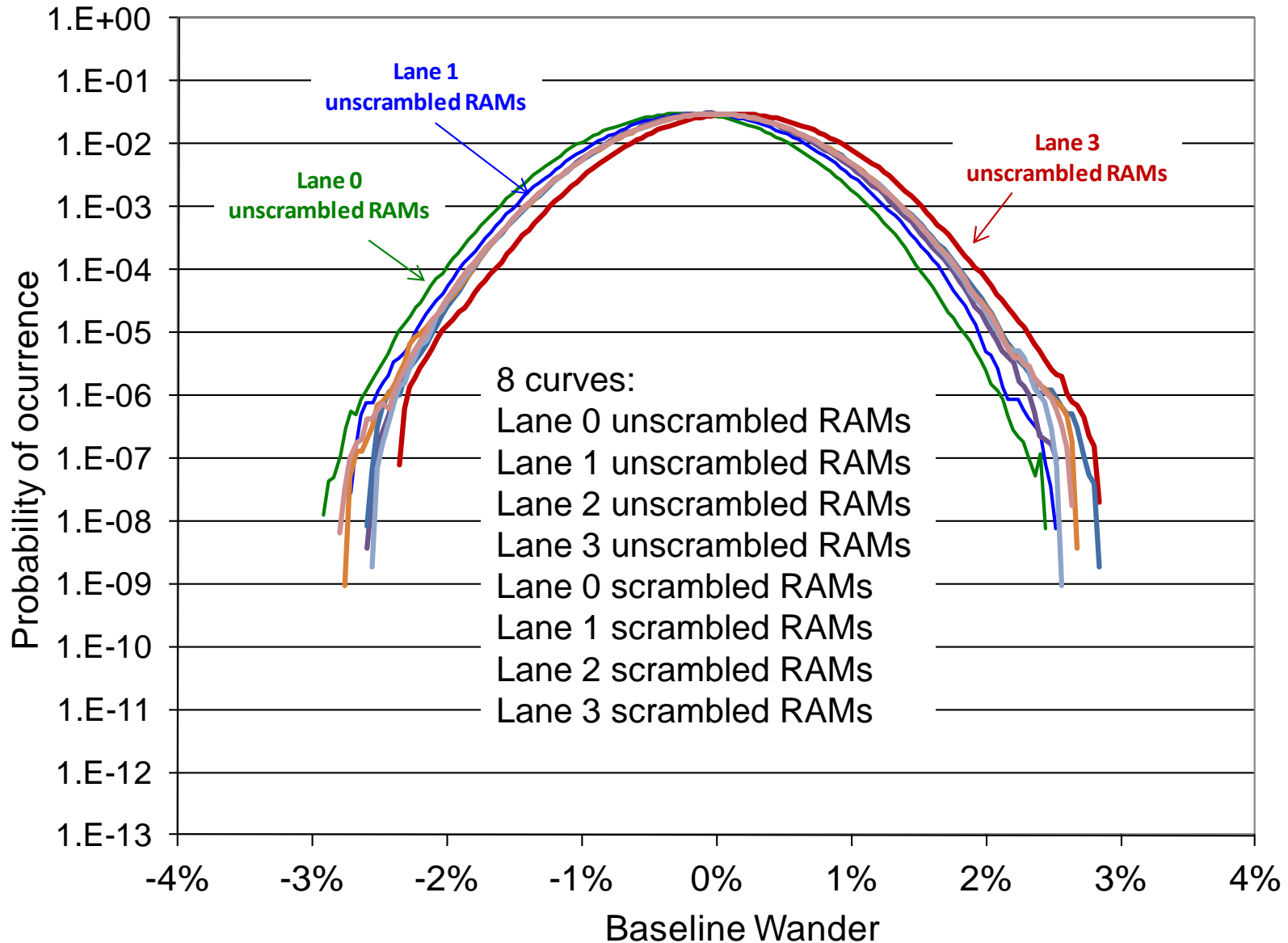

# Idle clock content PDFs with rapid AMs

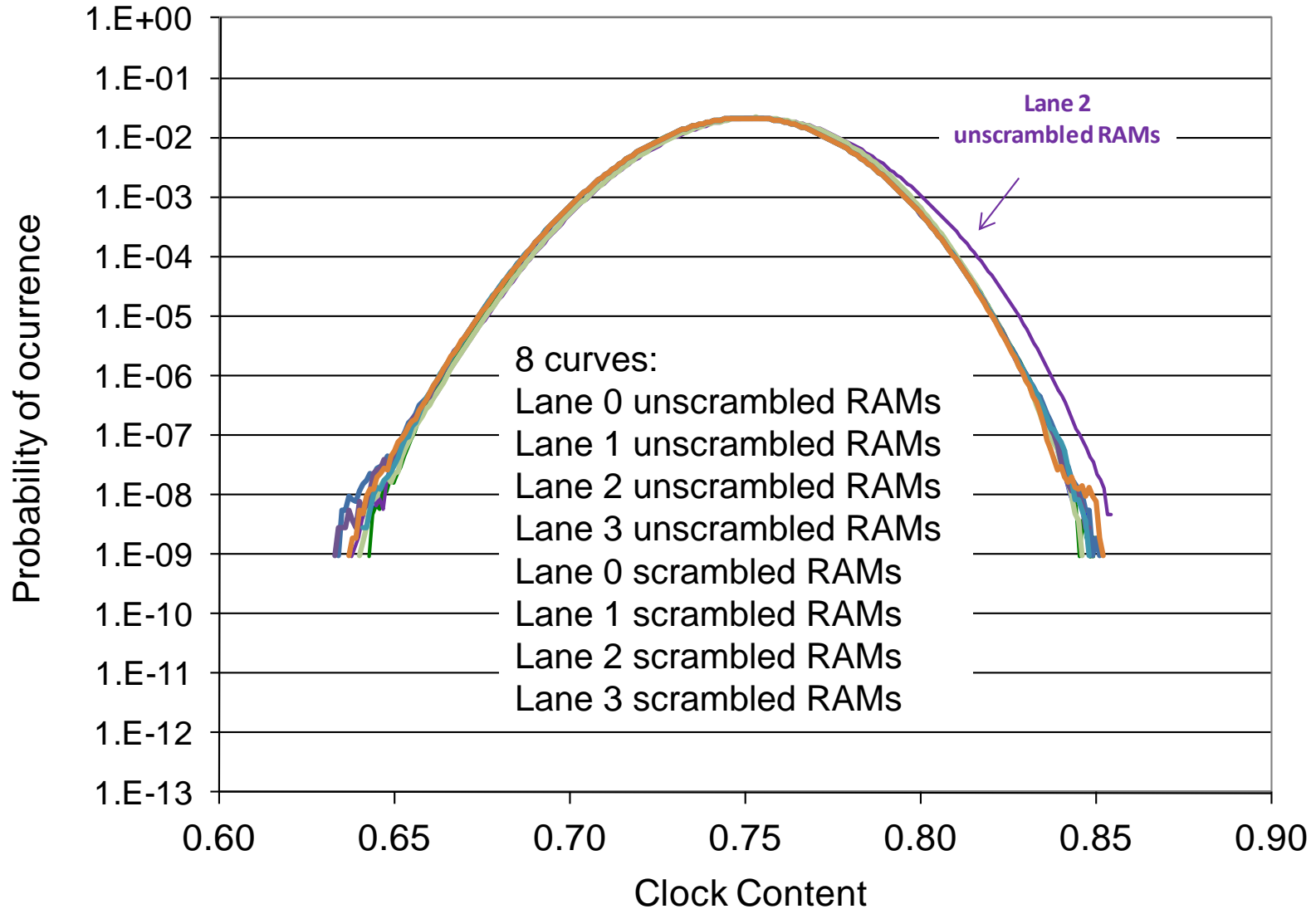

# Conclusion

The analysis carried out on this version of the PAM4 coding scheme has looked at the distribution of invariant symbols in the alignment marker sections of the four lanes (slide 8) and the PDFs for baseline wander (slides 9 & 11) and clock content (slides 10 & 12) of the four lanes containing scrambled idle both with scrambled AMs and unscrambled AMs.

The invariant symbol distribution is well within the range expected for random data.

There is no discernable difference in the PDFs for baseline wander and clock content between those with scrambled AMs and those with unscrambled AMs.

With rapid alignment markers (AMs in every other FEC block) there are some differences between the lanes, but these are still small.

The conclusion from this is that there is no need to scramble the alignment markers.

# Proposed changes to the baseline

Based on the simulations presented, the baseline wander and clock content of the unscrambled alignment markers are benign.

It is therefore proposed to modify the baseline proposal in [brown\\_01a\\_0312](#) such that the PAM4 FEC frame does not scramble the alignment markers.

Required modifications are shown on the following three slides.

# Changes to brown\_01a\_0312 slide 5

## Tx encoding flow

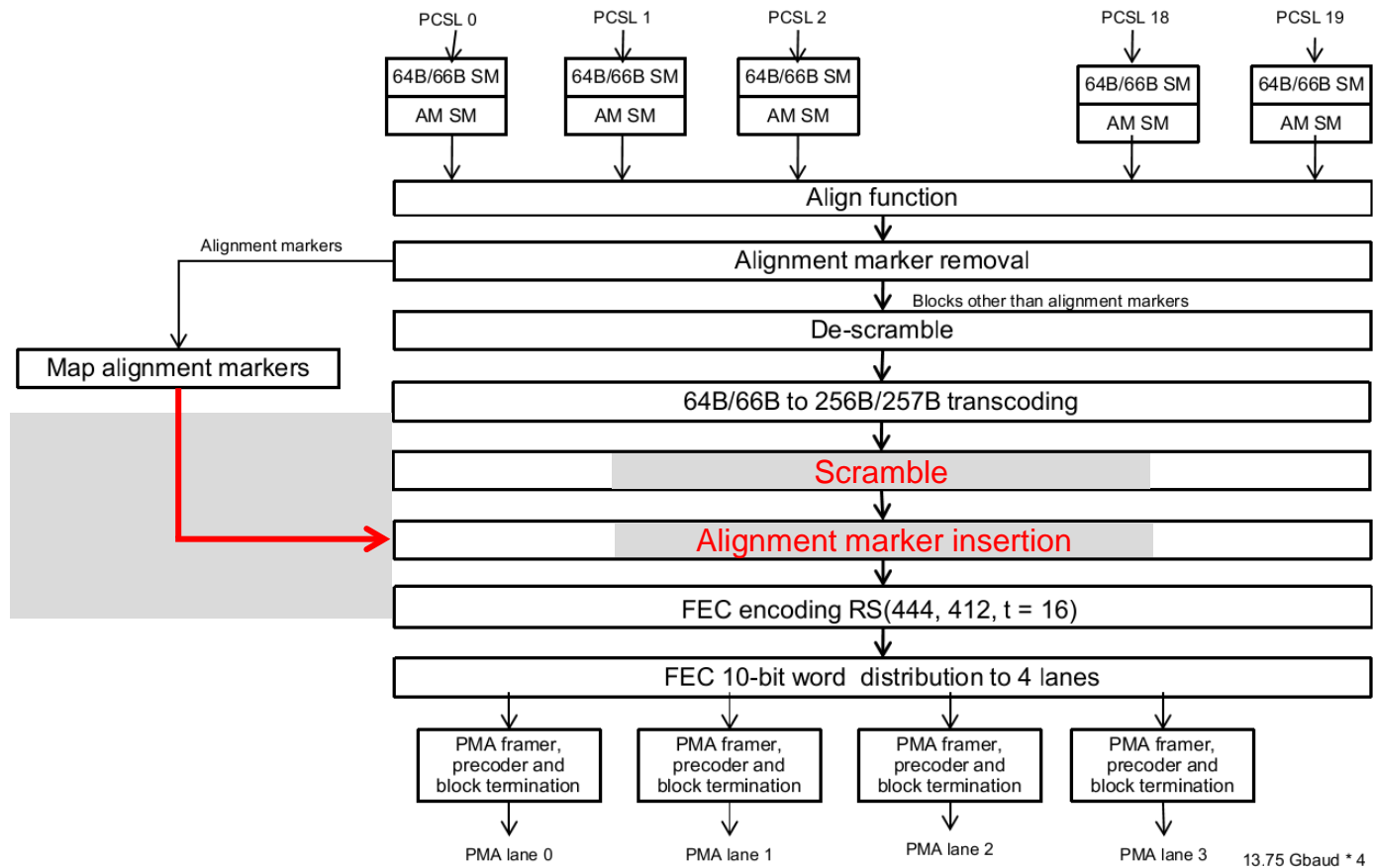



# Changes to brown\_01a\_0312 slide 6

## RX decoding flow

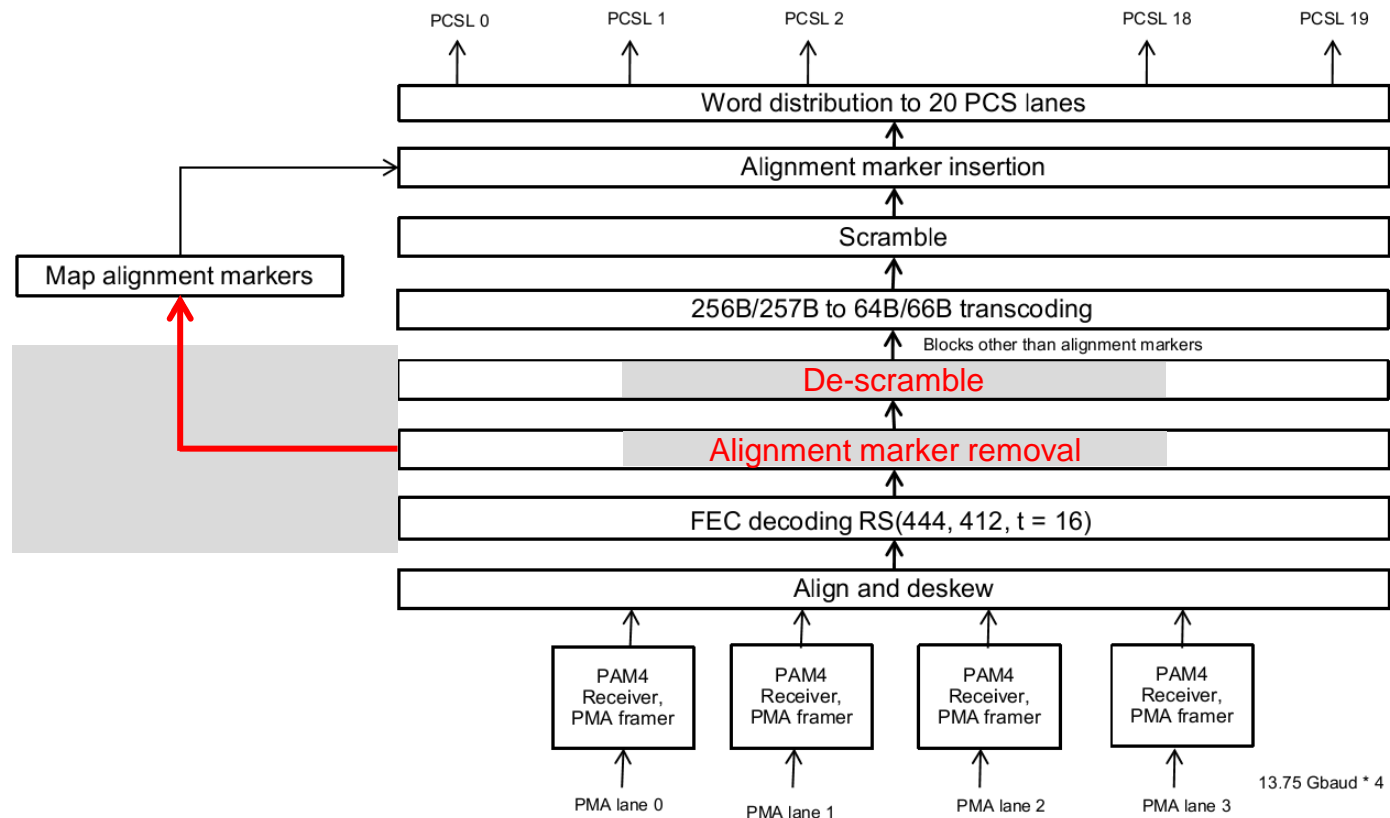

# Changes to brown\_01a\_0312 slide 9

## Scrambling

- Use self-synchronizing scrambler
  - Same scrambler as for PCS in 802.3ba 82.2.5.
  - All data bits including the 256B/257B header bits, but excluding the mapped alignment markers and the 5 “dummy” bits, are scrambled.
- Same as NRZ.

# Proposed changes to Draft 0.1

In order to implement the baseline changes shown on the previous slides, it is proposed to make the following changes to Draft 0.1.

Delete Note 2 in Figure 91-2 on page 77:

“NOTE2—THE SCRAMBLER FOLLOWS ALIGNMENT INSERTION FOR THE 100GBASE-KR4p PHY”

Delete the paragraph on lines 28-31 on page 79.

“When used to form a 100GBASE-KR4p PHY, the placement of the scrambler in the FEC transmit function is moved to follow alignment insertion. In other words, for a 100GBASE-KR4p PHY, the alignment markers, mapped per 91.4.2.8, shall also be scrambled.”

In 91.4.3.1, delete "When used to form a 100GBASE-KR4p PHY, the FEC scrambles the alignment markers making them unusable for synchronization."

In 91.4.3.4, change "For a 100GBASE-CR4 or 100GBASE-KR4n PHY, am\_rxmapped shall be removed prior to descrambling and transcoding." to "The vector am\_rxmapped shall be removed prior to descrambling and transcoding."

In 91.4.3.4, delete "For a 100GBASE-KR4p PHY, the descrambler shall precede alignment marker removal."

# Backup slides

# Idle baseline wander PDFs with rapid AMs

Effect of disabling passthrough of termination symbols (all pre-coded)

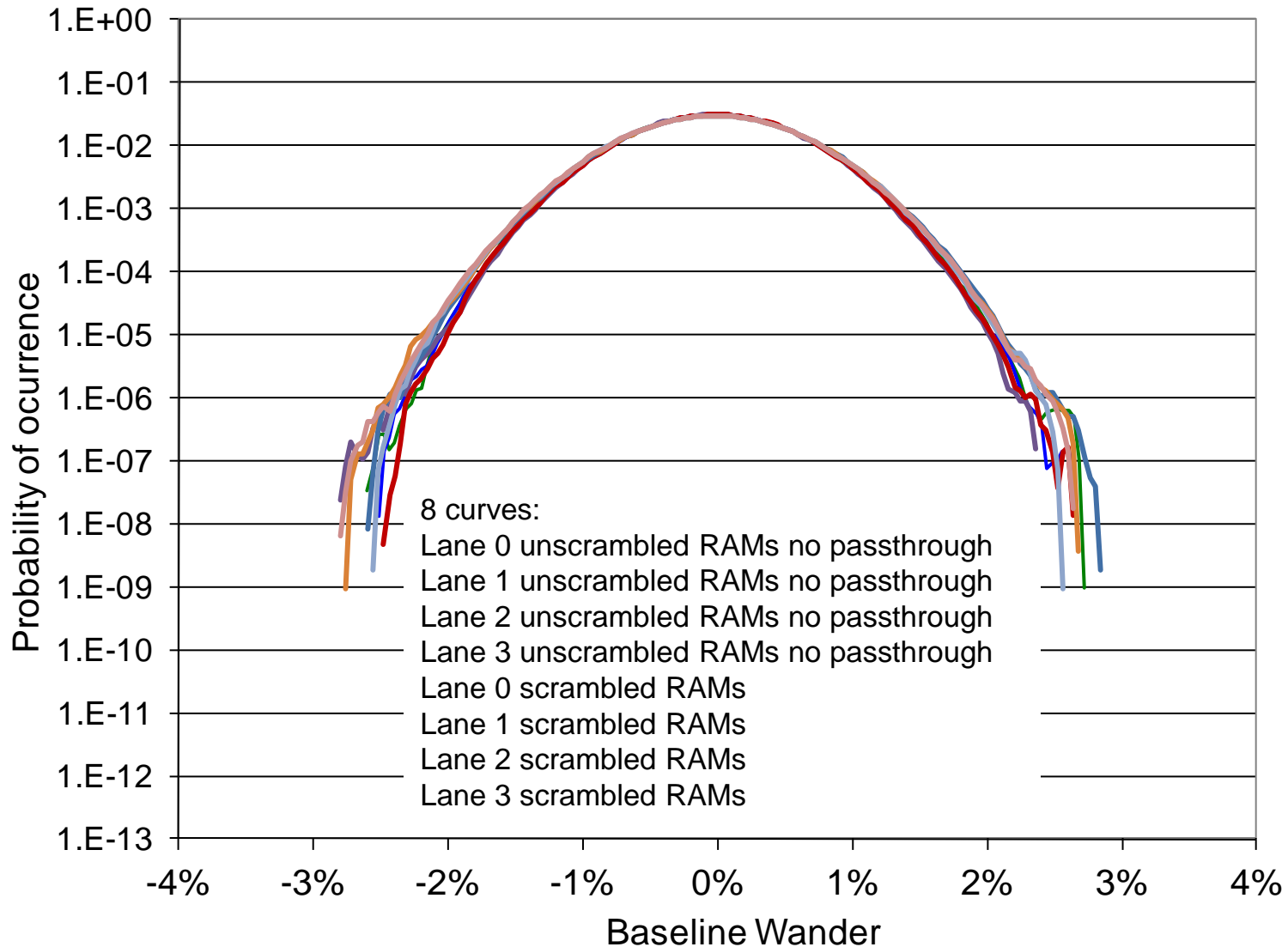

# Idle clock content PDFs with rapid AMs

Effect of disabling passthrough of termination symbols (all pre-coded)

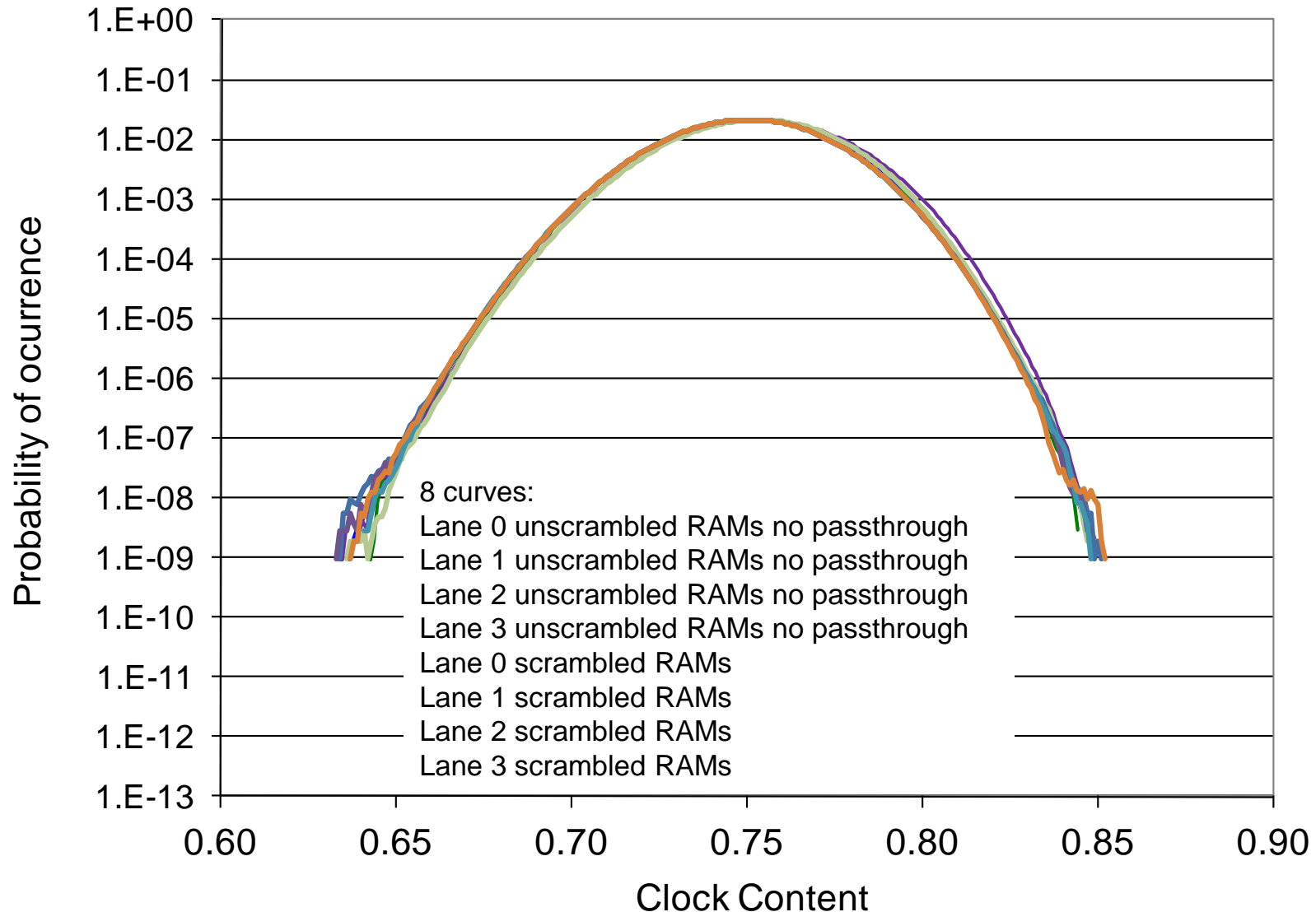

# Idle baseline wander PDFs with rapid AMs

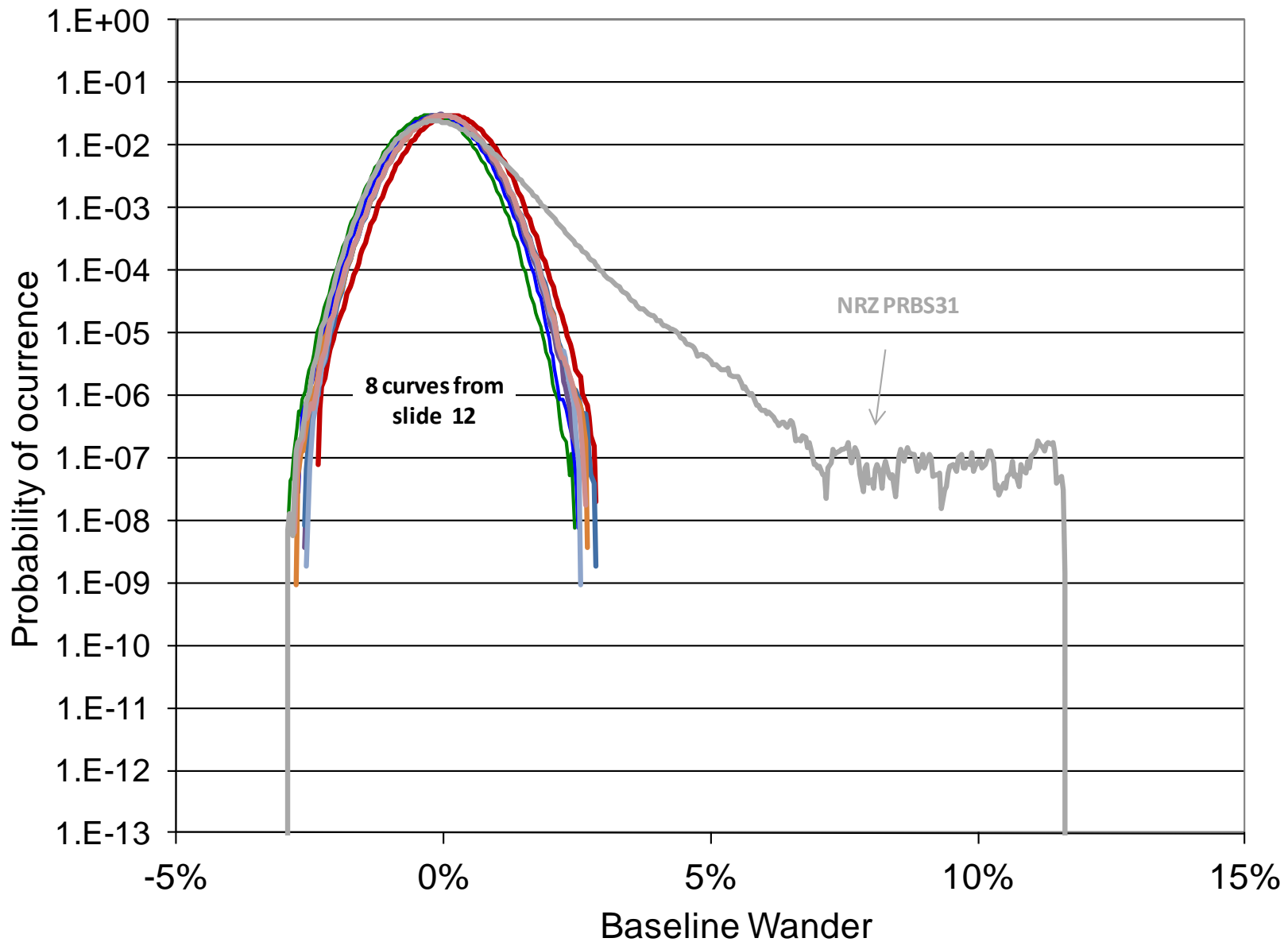

# Idle clock content PDFs with rapid AMs

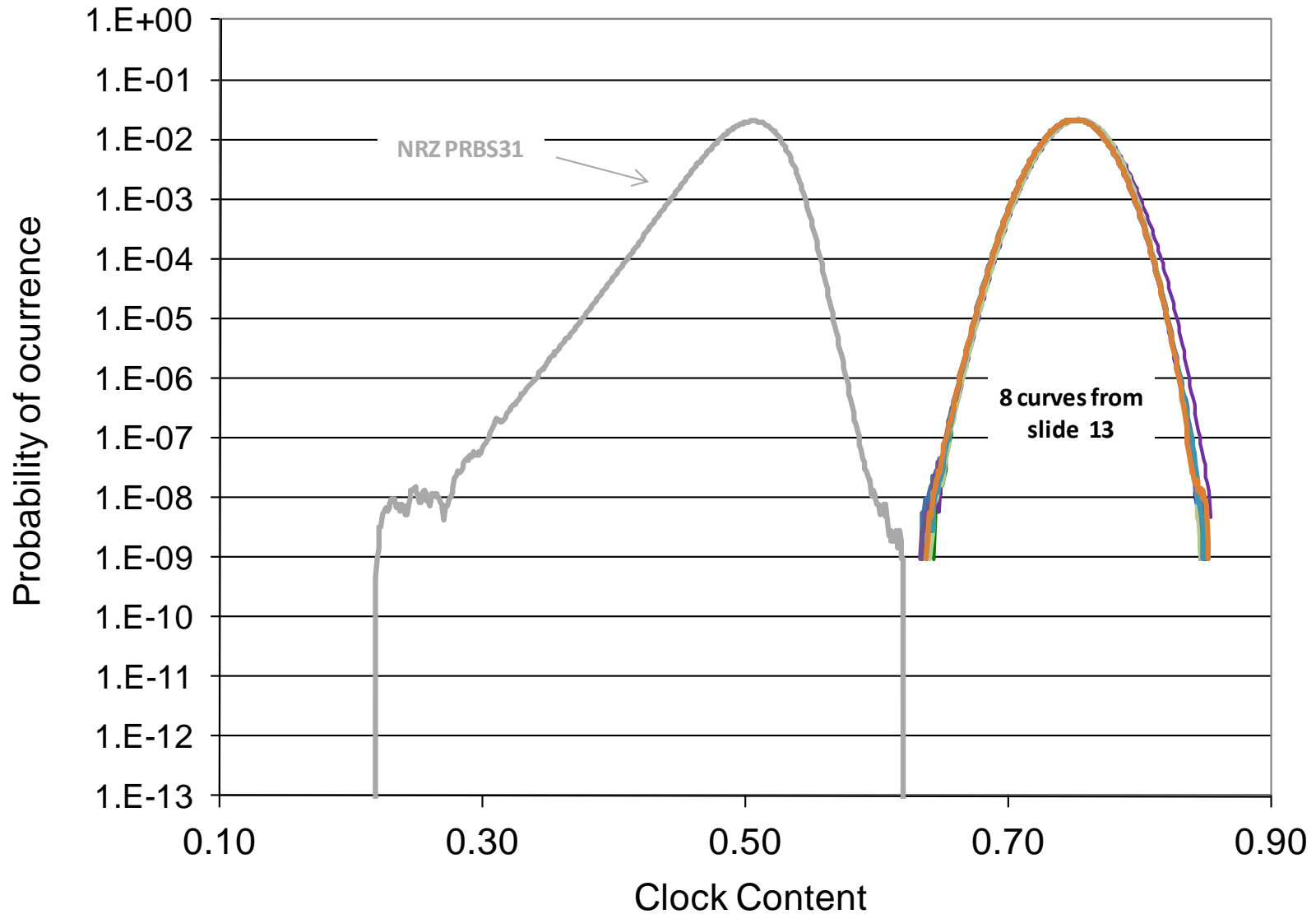



Thanks!