

Draft 100G SR4 TxVEC - TDP Update

John Petrilla: Avago Technologies

February 2014

Presentation Summary

Presentation Objectives:

- Review aspects of 100G SR4 TDP Update, petrilla_01_0114_optx
- Present updated simulation results for TDP and TxVEC
- Present updated comparisons of TDP and TxVEC tests

Link Model References

http://www.ieee802.org/3/bm/public/may13/petrilla_04_0513_optx.pdf

<http://www.ieee802.org/3/bm/public/may13/ExampleMMF%20LinkModel%20%20130503.xlsx>

<http://www.avagotech.com/docs/AV02-2485EN>

Review: 100G 100m SR4: Transition time & RIN12OMA tradeoff set TP2 contours (1)

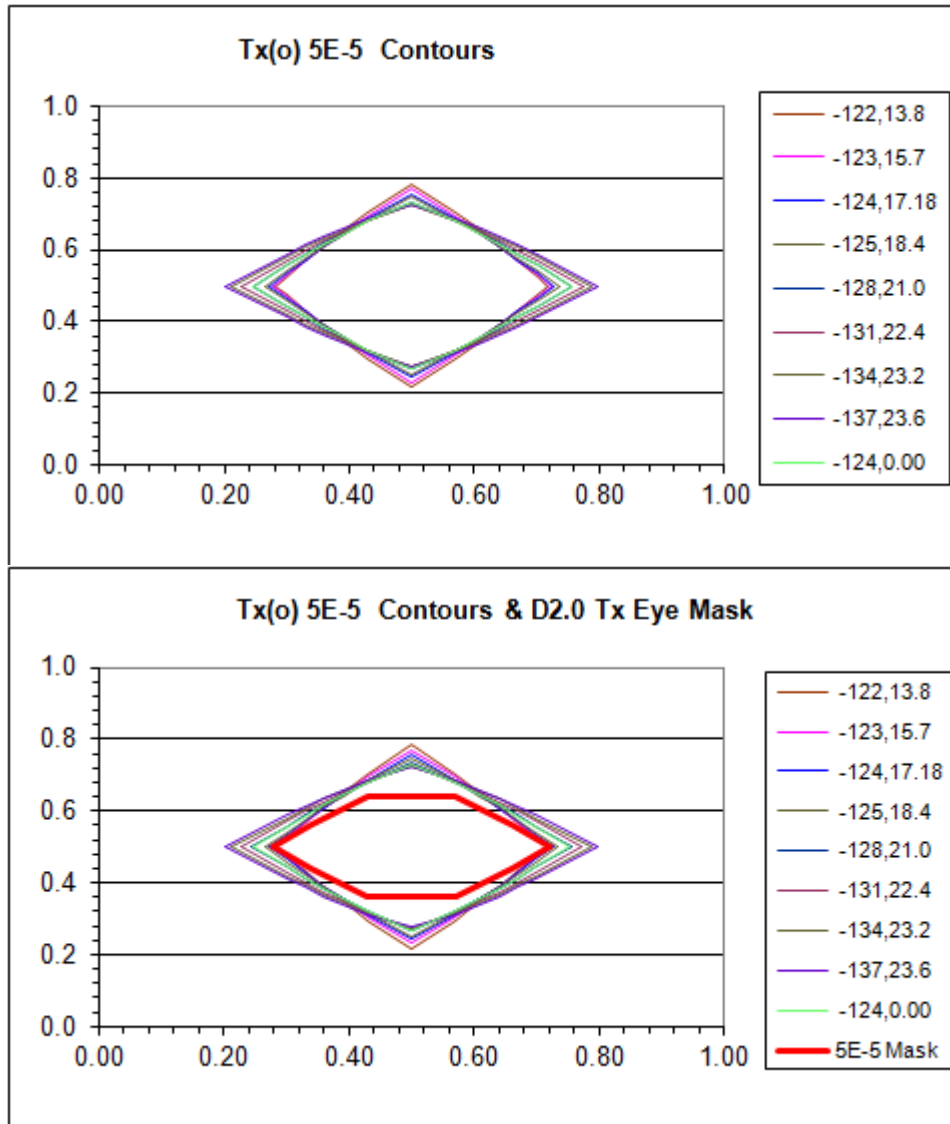

• For a system with three variables, transition time, RIN₁₂ OMA & jitter, and one result, link margin, there is no unique worst case, rather a multiplicity of worst cases. Each of these cases yields a slightly different eye contour as can be seen in the figures on the right as well as a different TDP value that will be discussed later.

• The top chart shows 5E-5 contours of the Tx output (TP2) for transition time and RIN₁₂OMA combinations providing zero link margin. Here a Gaussian response is assumed, consistent with the assumptions in the link model.

• The currently defined (draft 2.0) Tx eye mask is included in the bottom chart. It should be adjusted so that otherwise compliant transmitters are not rejected. **DONE**

• Items to notice in this set of contours:

- 1, All of the Tx and TP1 attributes that are intended to be captured in the TDP metric are captured in these contours.
- 2, The vertical position of a point on a contour represents the signal amplitude at that point relative to OMA and permits a measure of vertical eye closure.
- 3, There's a crossover point where the variations in time and amplitude are minimized that, perhaps, offers a tighter relationship with link margin than TDP offers (more on this later).

Review: 100G 100m SR4: Attribute tradeoffs using TDP & Link Margin (1)

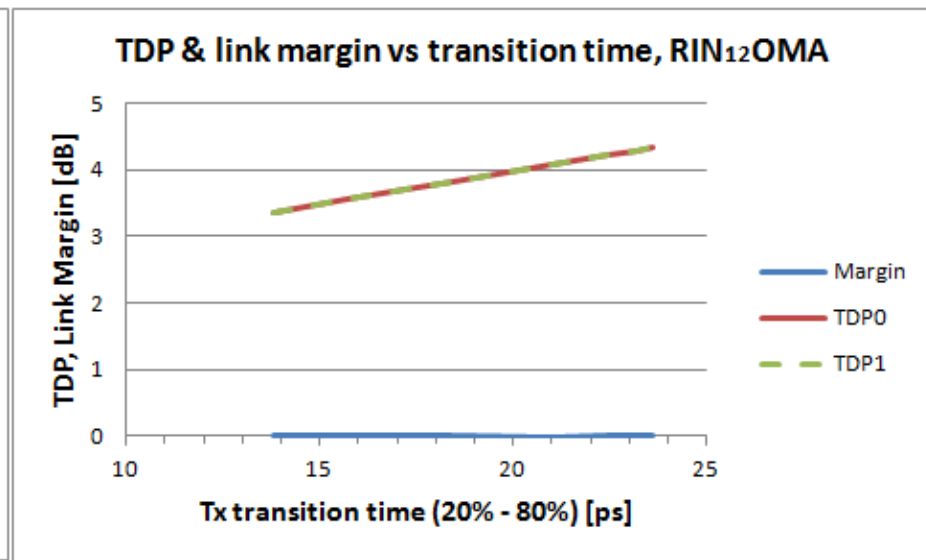
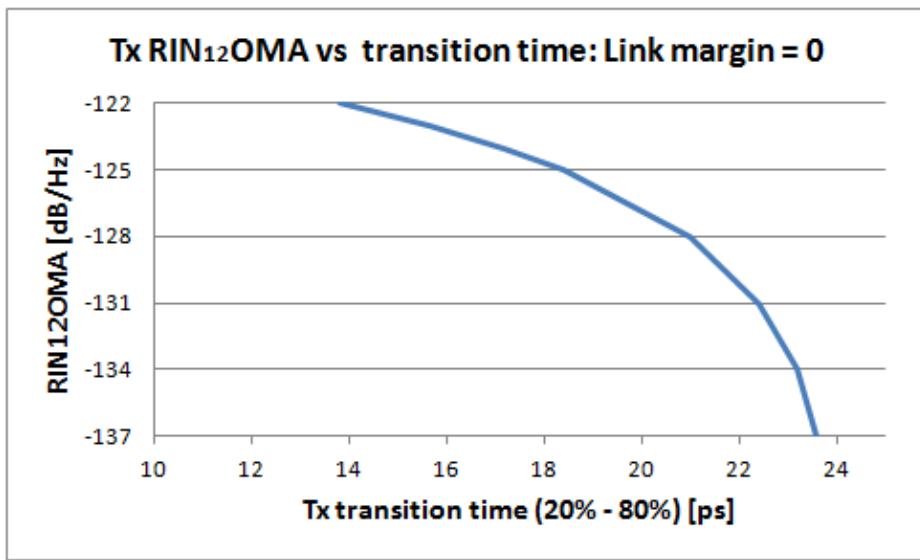

•The top left chart shows the tradeoff between Tx transition time and RIN₁₂OMA using the Example Link Model when holding link margin constant at 0 dB. The values in the Example Link Model are transition time = 21 ps and RIN₁₂OMA = -128 dB/Hz.

•The top right chart shows TDP values calculated for the combinations of transition times and RIN₁₂OMA. Here TDP0 is for a 100 m reach case and TDP1 is for the test filter case. While the link margin is constant the TDP results are not, i.e. TDP does not tradeoff transition time and RIN as the link model does.

•The bottom right chart shows the deviation in link margin and TDP from the initial combination of transition time = 21 ps and RIN₁₂OMA = -128 dB/Hz. Positive Δ TDP values may lead to test escapes and negative values may lead to rejecting acceptable units.

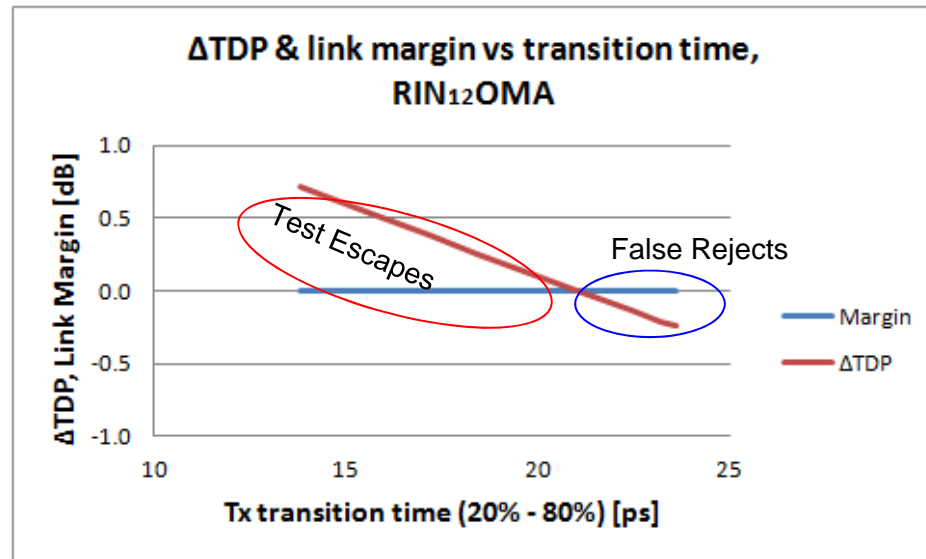

Review: 100G 100m SR4: TDP & Link Margin sensitivities

TDP vs Link Model Margin: DJ, RIN, tr/tf

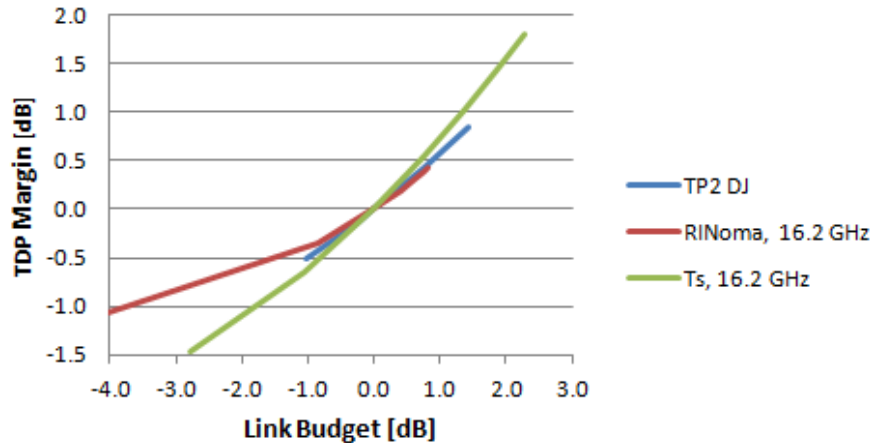

TDP vs Link Model Margin: DJ, RIN, tr/tf

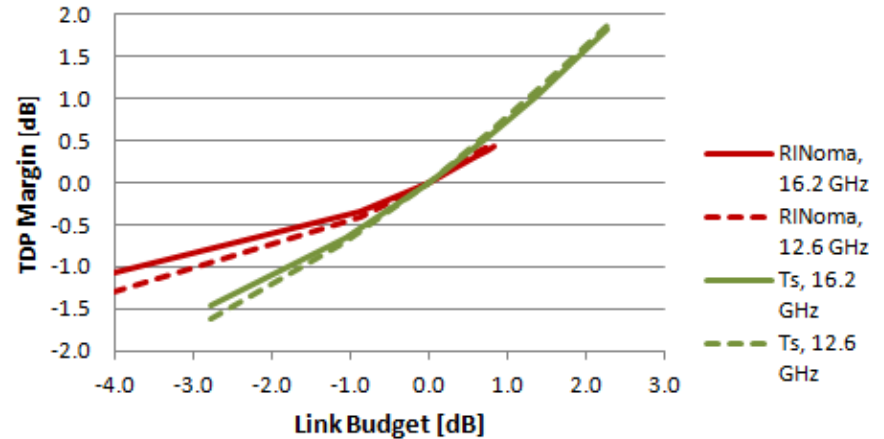

- Here attributes are examined individually for effect on link model and TDP margin. Then the effect on TDP margin is compared to the link model margin. For reference TDP was computed using 16.2 GHz and 12.6 GHz filters. In addition, SM cases were explored.

- The alignment of TDP with link margin is different for MMF cases with respect to SMF cases.

- The TDP MM filter bandwidth has an affect but it's not sufficient to resolve the problem.

TDP vs Link Model Margin: tr/tf, RINoma

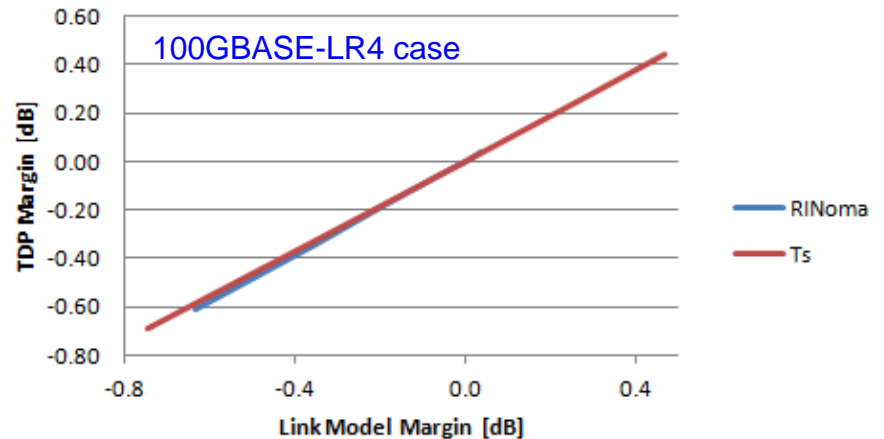

Review: 100G 100m SR4: Why MMF & SMF yield TDP differences

TDP vs Link Model Margin: DJ, RIN, tr/tf

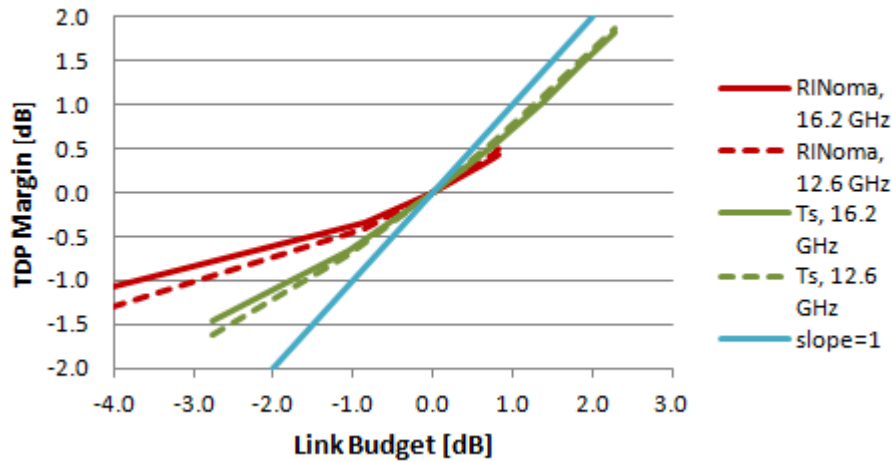

Margin (TDP vs Link Model) for $t_t[17:25 \text{ ps}]$

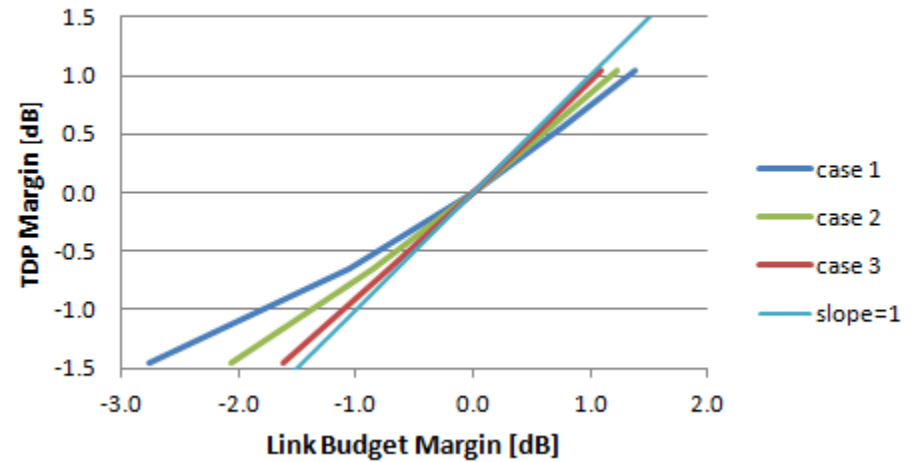

- Above it was shown that while SMF yields a one-to-one alignment between link model margin and TDP, MMF does not.
- The top left chart is a repeat of MM cases with a slope=1 line added.
- The top right chart shows three link model cases: case 1 = original WC link model, case 2 replaces Rx from original link model with one with same jitter and BW as the Ref Rx in TDP test, case 3 = case 2 and zeroes out BLW, Pmn and Pmpn.
- As shown in the bottom right chart, the difference in link budget margin and TDP is due to absence of BLW, Pmn and Pmpn that are not captured in the TDP test and differences between the Ref Rx and WC Rx.

Pcross vs t_t : Base and TDP cases

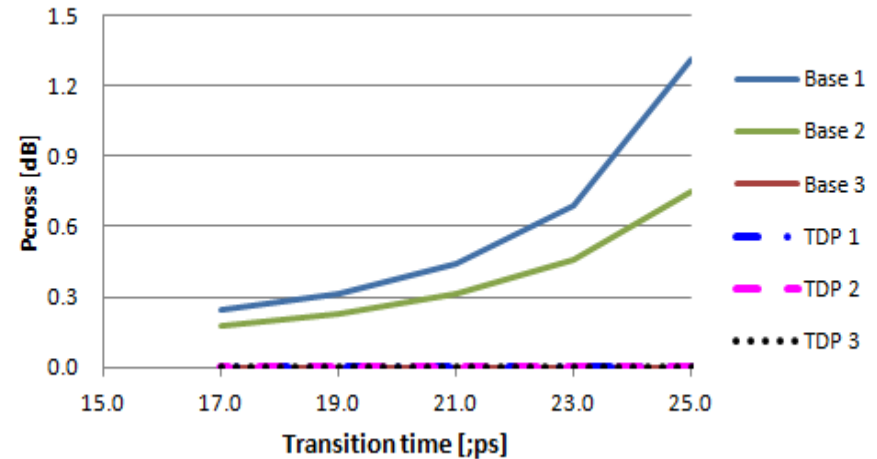

New: 100G 100 m SR4: Zero Margin Cases

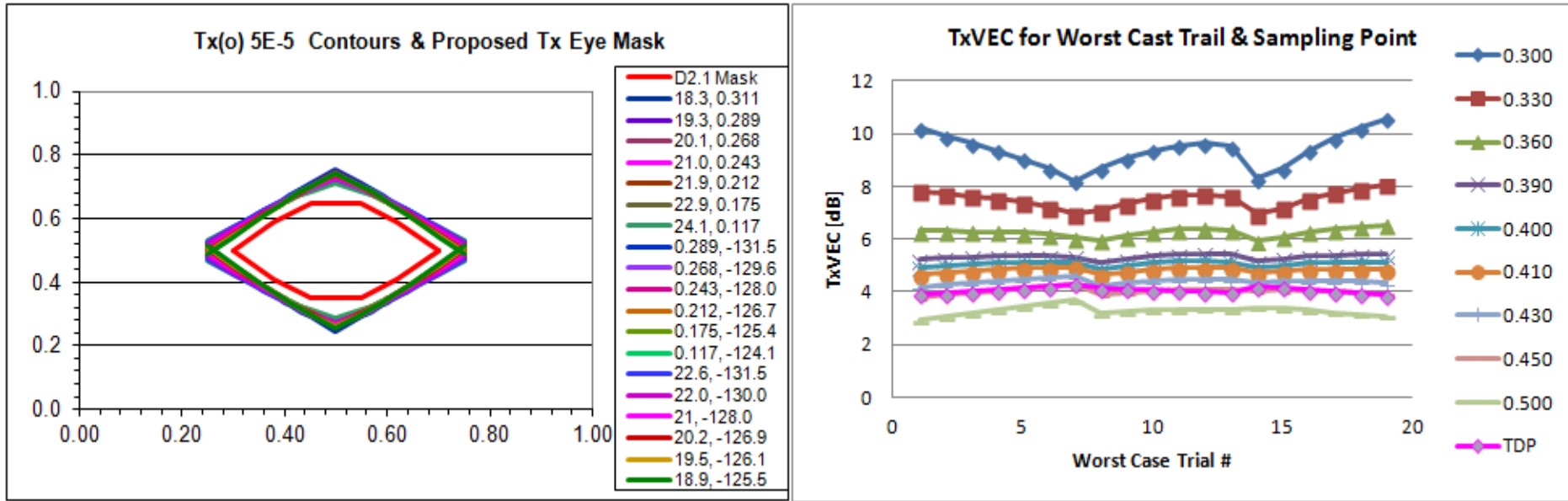

- The above left chart show Tx output contours for a family of worst case transmitters as well as the Tx eye mask defined in draft 2.1.
- The above right chart shows, for this worst case family, TDP and VEC calculated for various sampling points in the unit interval where 0.50 is the center of the eye.
- Variability in the TxVEC and TDP results can be seen among the family of worst case transmitters.
- Variability in the TxVEC result is minimized in the region of 0.39 UI to 0.41 UI.
 - For 0.39 UI, Max TxVEC – Min TxVEC = 0.34 dB
 - For 0.40 UI, Max TxVEC – Min TxVEC = 0.31 dB
 - For 0.41 UI, Max TxVEC – Min TxVEC = 0.29 dB
 - For TDP, Max – Min = 0.43 dB
- The minimum variability TxVEC region appears sufficiently wide to permit reasonable accuracy in placing the histograms for the TxVEC measurement and/or reasonable width in the histogram to enable acceptable sample collection times.

New: 100G 100 m SR4: Tx Attribute Margin Sensitivities (1)

TDP & TxVEC Margin vs Link Model for tr, tf

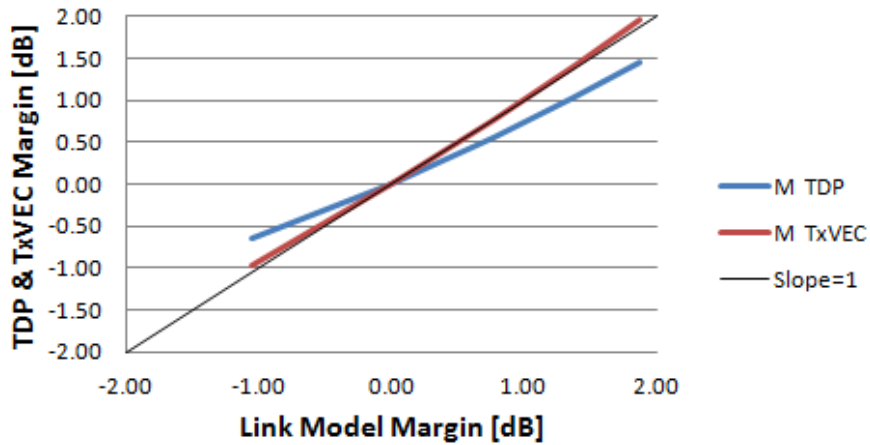

TDP & TxVEC Margin vs Link Model for RINoma

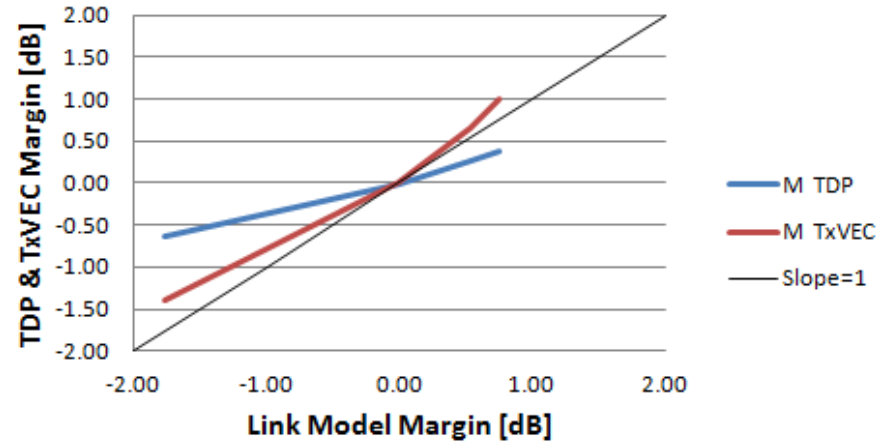

TDP & TxVEC Margin vs Link Model for TP2 DJ

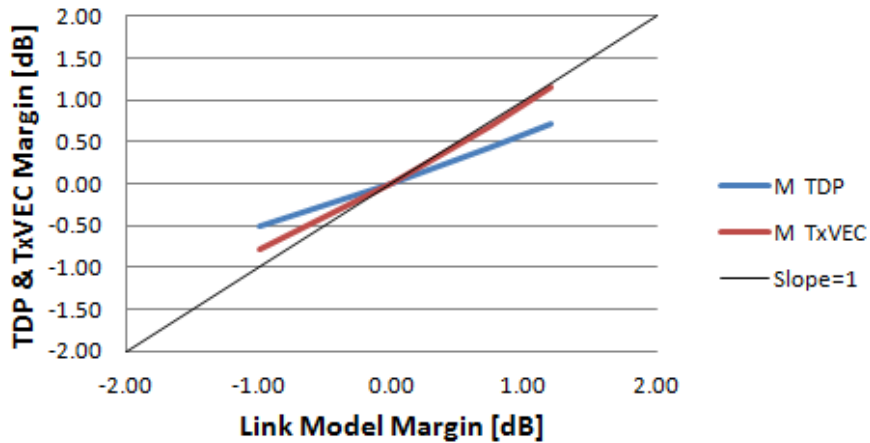

- Here Tx attributes are re-examined, this time for effect on TxVEC as well as on link model and TDP margin.
- For each Tx attribute, TxVEC is more closely aligned with link margin than TDP.

New: 100G 100 m SR4: Tx Attribute Margin Sensitivities (2)

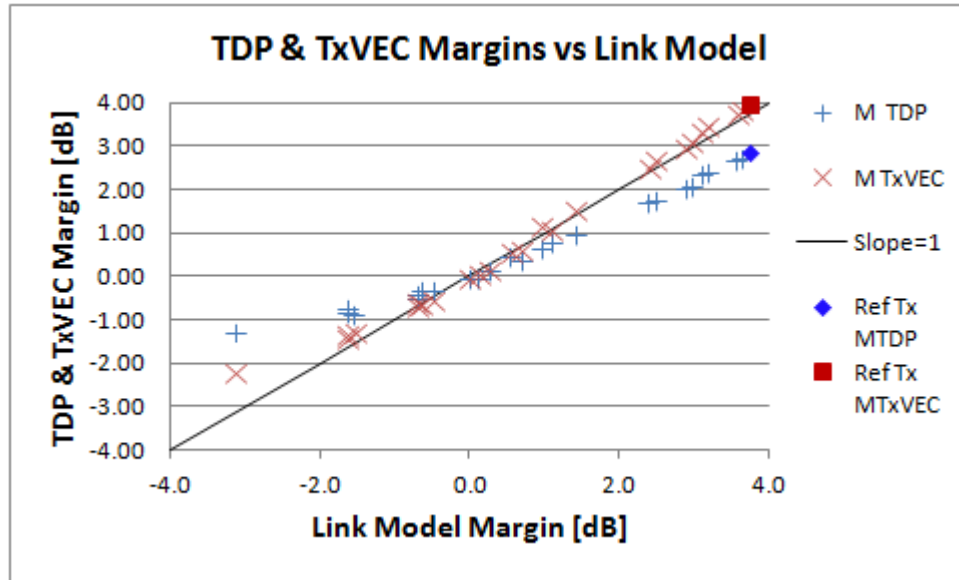

An example TDP Ref Tx (transition time = 12 ps, RINoma = -134 dB/Hz, TP2 DJ = 0.082 UI) is expected to provide 3.77 dB link model margin and a TDP value of 1.23 dB for a 2.86 dB TDP margin.

- Here TxVEC, TDP and link model margin are explored for a wider range of Tx attributes.
Transition times: 12 to 22.4 ps; RINoma: -125 to -134 dB/Hz; TP2 DJ: 0.082 to 0.284 UI
- Over the wider range, TxVEC continues to be better correlated with link model margin than TDP.
For positive margin cases, where devices may be shipped, margin correlation was within 0.25 dB.
For negative cases, devices will not be shipped and margin correlation loses relevance.
- The ranges were expanded to include attributes that may be seen in the Draft 2.1 TDP Ref Tx. (See 802.3bm/D2.1 Cl 95.8.5 d)
- **The poor correlation between link model margin and TDP calls into question the tradeoff between TDP and min OMA.**

New: 100G 100 m SR4: Tx Mask Margin in lieu of TDP

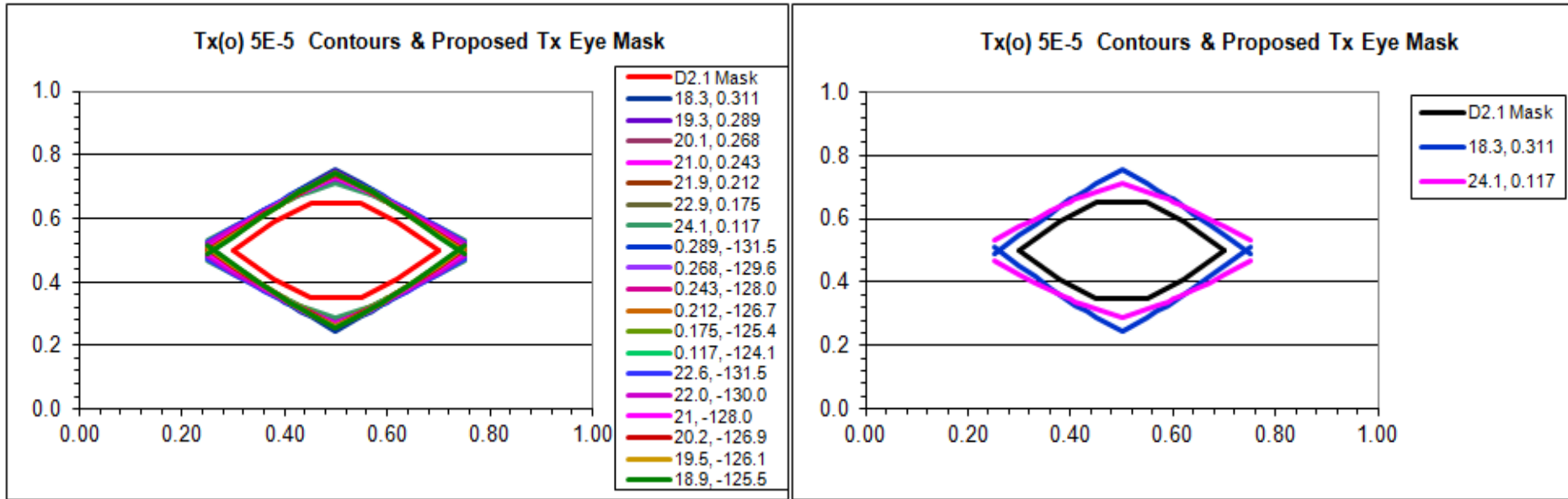

- Due to the difficulties of TDP measurements, some have looked to Tx mask margin as a predictor of link margin.
- Problems associated with use of Tx mask margin start with the lack of a common definition, i.e., different test equipment vendors use different mask margin algorithms yielding different results for a Tx under test.
- Further, while the chart on the left with the overlay of 19 zero-link-margin device contours may lead to the conclusion that there could be common mask margin result for all these cases with the same link margin, the chart on the right with just two of the cases shows the likelihood of different mask margin results from devices with the same link margin.
- Defining a TxVEC test may reduce the incentive to use non-standardized tests and reduce the confusion and/or frustration that occurs when correlation is sought between mask margin test results for cases where a vendor is using a set of test equipment with one mask margin algorithm and the customer is using a different set of test equipment with a different mask margin algorithm.

Review: 100G 100m SR4: A metric to replace TDP (1 of 4)

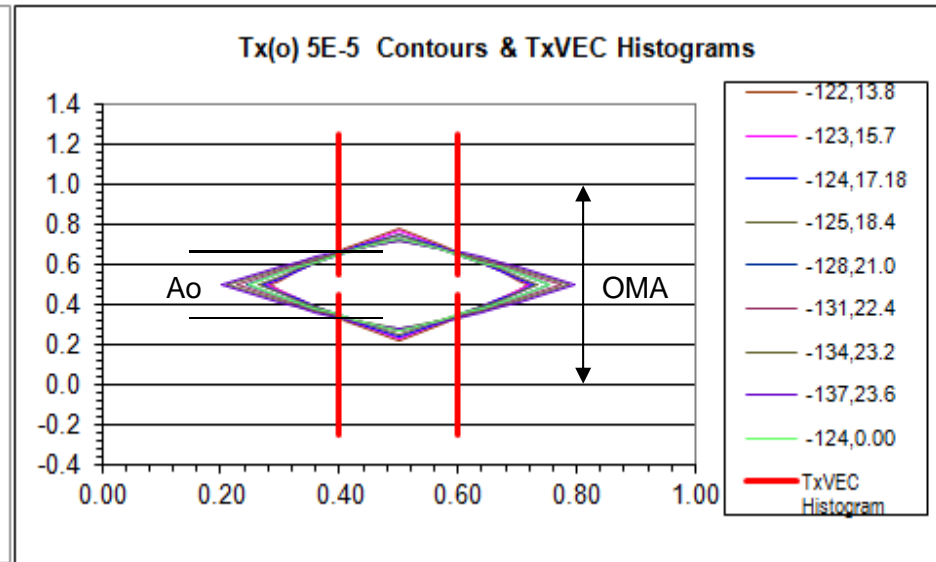
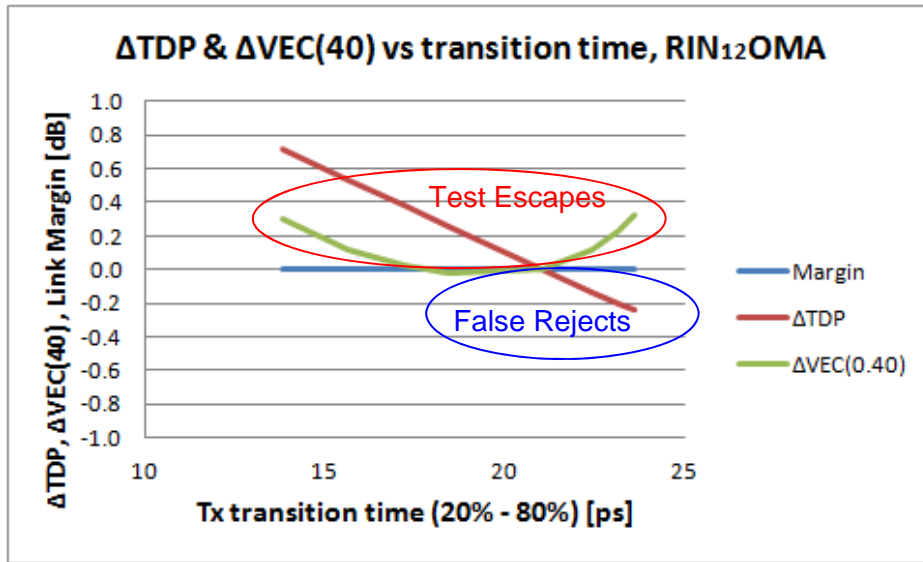

•The chart on the left indicates that a TxVEC metric, where $TxVEC = 10\log_{10}(OMA/Ao)$, can offer a better balance of test-escapes versus false-rejects than a TDP metric. Here histograms are taken at ± 0.10 UI offsets from the center of the eye. Ao is the vertical eye height between 5E-5 points on the histogram tails. OMA is the signal amplitude measured with the OMA measurement method.

•The $\DeltaVEC(0.40)$ line is based on deviation from TxVEC calculated for the Tx baseline condition of a 21 ps Tx transition time and a RIN₁₂OMA of -128 dB/Hz. For this baseline condition TxVEC = 5.12 dB and based on this condition a TxVEC max = 5.1 dB is recommended.

•Note that there is no need for a reference transmitter for the TxVEC measurement. With the inability of TDP to predict link margin shown above, the use of a non-ideal Ref Tx to calibrate the Sensitivity of the Ref Rx is suspect.

•Also note that Fibre Channel uses a transmitter vertical eye closure metric for MMF transmitters and not TDP.

Review: 100G 100m SR4: A metric to replace TDP (3 of 4)

Proposed replacement text for 95.8.5

95.8.5 Transmitter Vertical Eye Closure

Transmitter Vertical Eye Closure (TxVEC) shall be as follows:

- Each optical lane is tested individually with all other lanes in operation.
- The transmitter is tested using an optical channel with an optical return loss of 12 dB.
- OMA shall be measured as defined in 95.8.4.
- The transmit eye is observed as defined in 95.8.7 with the following exception: eye mask coordinates are not applied.
- The transmitter optical waveform is measured for vertical eye closure (TxVEC), as defined in Equation (52-4) for vertical eye closure penalty, but evaluated at ± 0.1 UI from the eye center and A_o is the amplitude of the eye opening from the 99.995th percentile of the lower histogram to the 0.005th percentile of the upper histogram. A_o is the smaller of the two measurements.
- The test setup illustrated in Figure 52-9 shows the reference method. Other measurement implementations may be used with suitable calibration.
- TxVEC is defined for each lane, at the BER specified in 95.1.1 and is for the lane under test on its own. See 95.8.1.1 for multi-lane pattern considerations. NOTE—Sampling instant offsets have to be calibrated because practical receivers and decision circuits have noise and timing impairments. One method of doing this is via a jitter bathtub method using a known low-jitter signal.

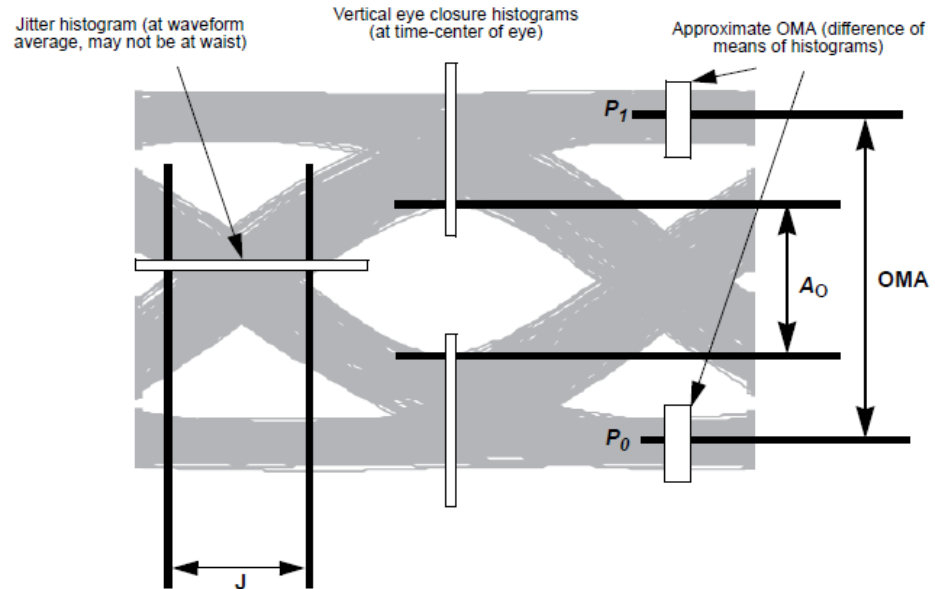
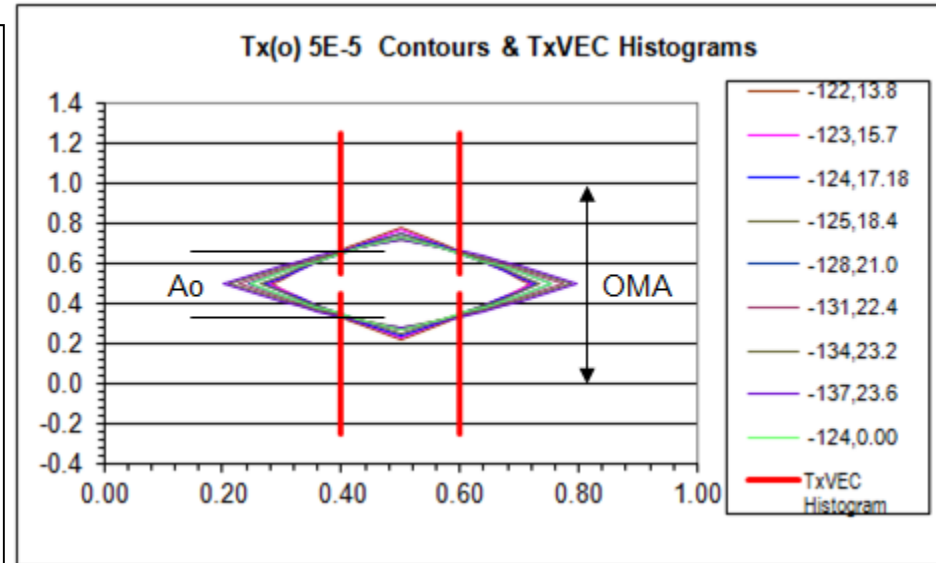
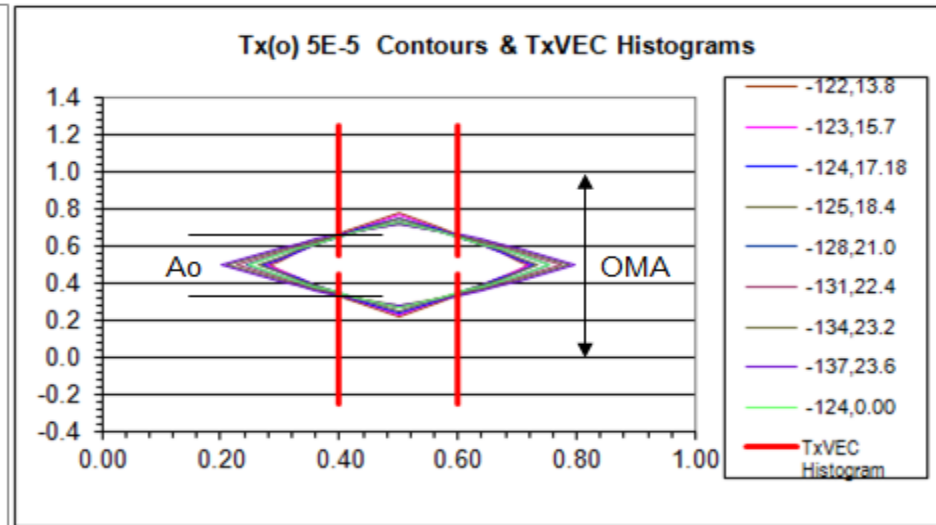
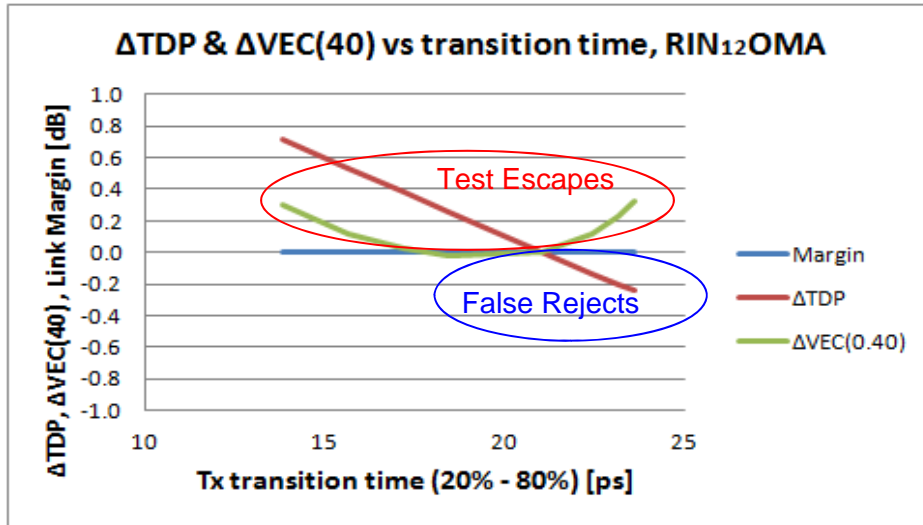

Figure 52-11—Required characteristics of the conformance test signal at TP3

Review: 100G 100m SR4: A metric to replace TDP (2 of 4)



- Based on the new metric TxVEC, in Draft 2.0 replace
 - in Table 95-6, Transmitter and dispersion penalty (TDP), each lane (max) = 5 dB
with Transmitter vertical eye closure, each lane (max) = 5.1 dB
 - in Table 95-6, Launch power in OMA minus TDP (min) = -8 dBm
with Launch power in OMA minus TxVEC (min) = -8.1 dBm
 - in Table 95-6, Optical Modulation Amplitude (OMA), each lane (min)^b = -7.1 dBm
with Optical Modulation Amplitude (OMA), each lane (min)^b = -7.2 dBm
 - in Table 95-6, footnote b, Even if the TDP < 0.9 dB, the OMA (min) must exceed this value.
with Even if the TxVEC < 0.9 dB, the OMA (min) must exceed this value.
 - in Table 95-8, Power budget (for max TDP) = 8.2 dB
with Power budget (for max TxVEC) = 8.2 dB
 - in Table 95-8, Allocation for penalties (for max TDP) = 6.3 dB
with Allocation for penalties (for max TxVEC) = 6.3 dB

New: 100G SR4: TDP & TxVEC Test Setups

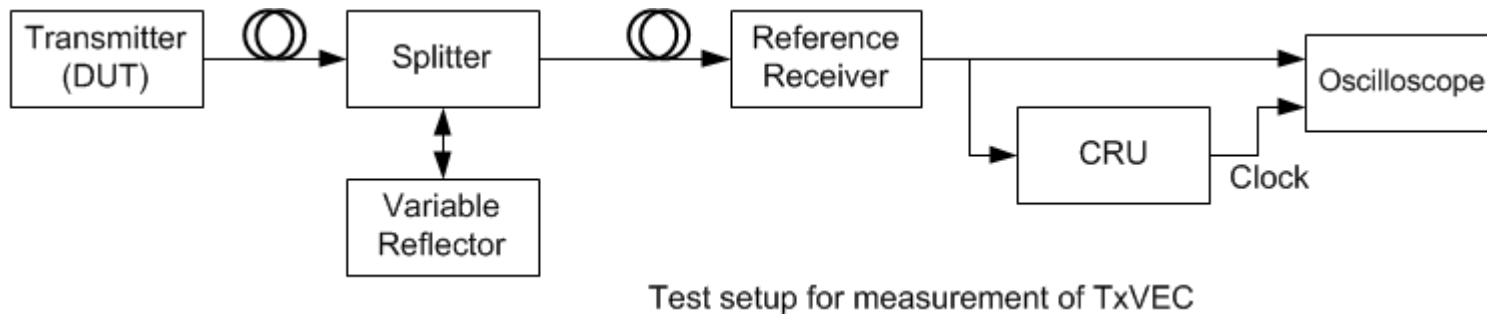
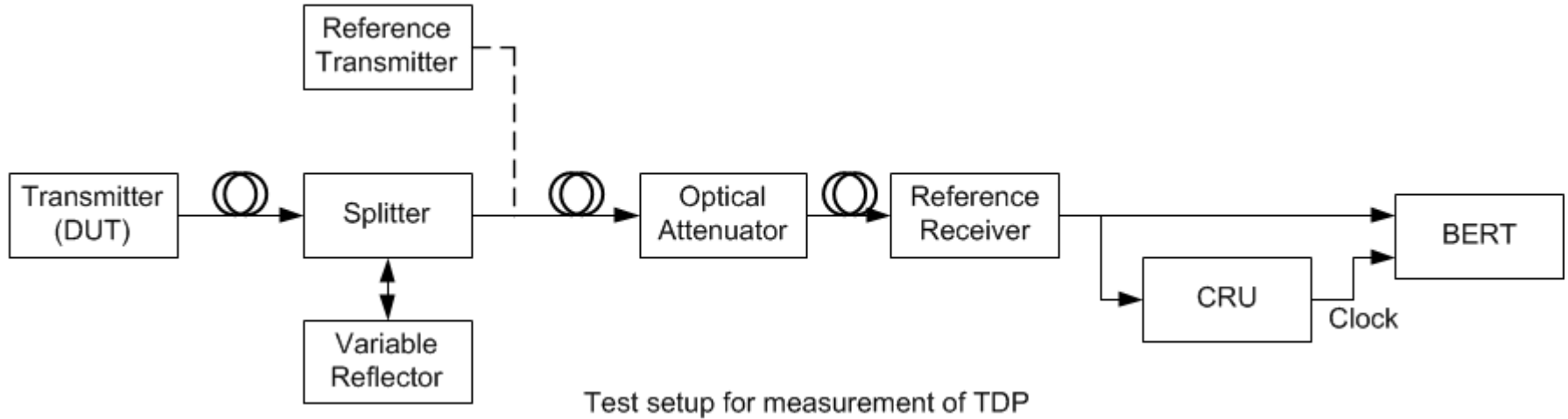

- The above drawings show setups for measurement of TDP and TxVEC.
- Significant differences include:
 - The Tx VEC setup does not need a Reference Transmitter.
 - The Reference Receiver for TxVEC can be an oscilloscope with an optical plug-in.
- Setup and calibration of the TxVEC setup is expected to be significantly easier.

New: 100G SR4: TDP & TxVEC Test Setups

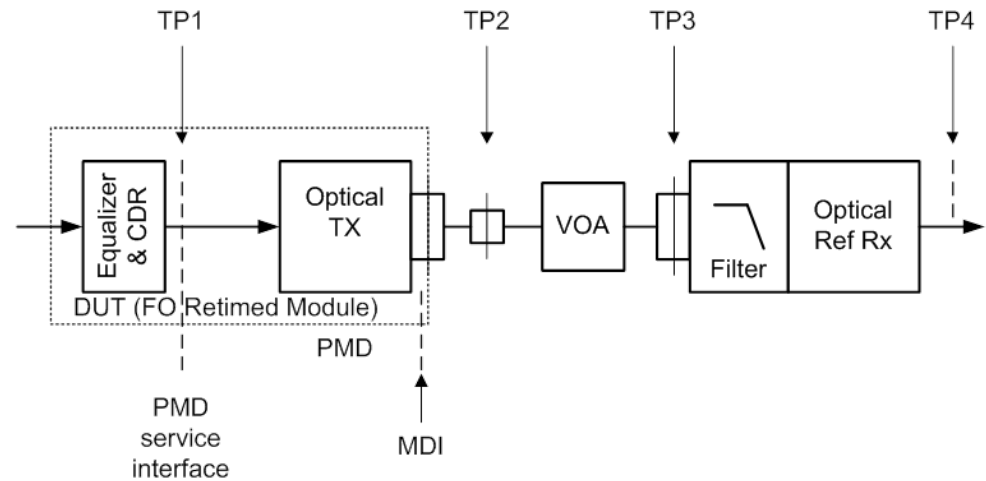
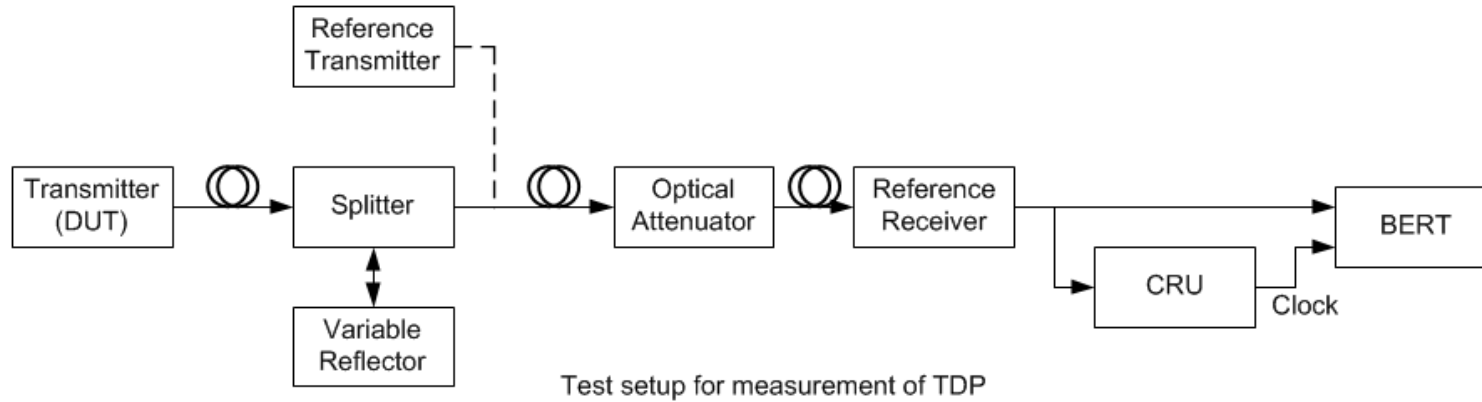

The above figures shows another view of the TDP Ref Rx. Here the TDP filter is combined with an optical Rx.

New: 100G SR4: TDP & TxVEC Test Setups

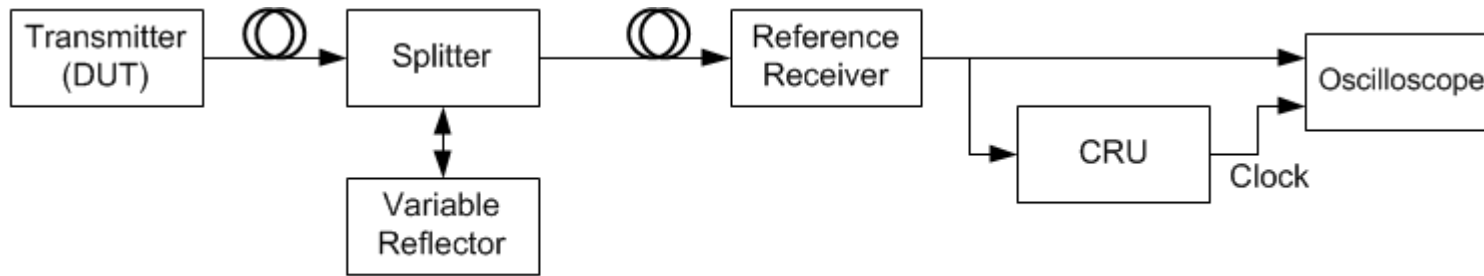

Test setup for measurement of TxVEC

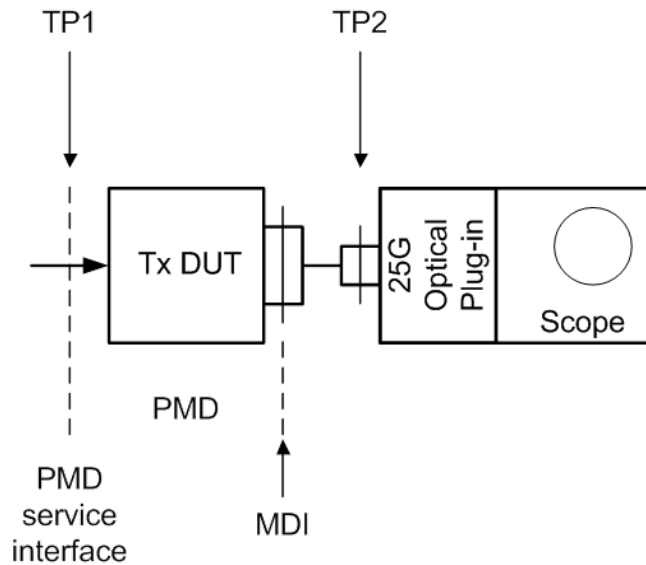

The above figures shows another view of the TxVEX Ref Rx, simply an oscilloscope with an optical plug-in.

Review: 100G 100m SR4: A metric to replace TDP (4 of 4)

Transmitter and dispersion penalty (TDP) Summary

- TDP results for MMF cases are not well aligned with margin calculations from the link model.
- TDP measurements require either an ideal reference transmitter or the ability to calibrate a reference for TDP with respect to the ideal. Since TDP results are not well aligned with link model margin, such a calibration now seems problematic. Underestimating the TDP of the Ref Tx is easy, perhaps common, permitting test escapes.
- TDP requires a reference receiver with a non-standard BW that will need setup and calibration.
- The complexities with TDP has limited its acceptance and use in the industry.

Transmitter Vertical Eye Closure (TxVEC) Summary

- TxVEC results for MMF cases are better aligned with link model margin than TDP results, promising a better balance of test escapes with rejecting acceptable devices.
- TxVEC does not require a reference transmitter.
- The Ref Rx for TxVEC can be an oscilloscope with a standard optical plug-in for the 25G signal rate.
- TxVEC uses the same test setup as the Tx eye mask test and same techniques as SRS VECP; no new equipment or techniques are needed.

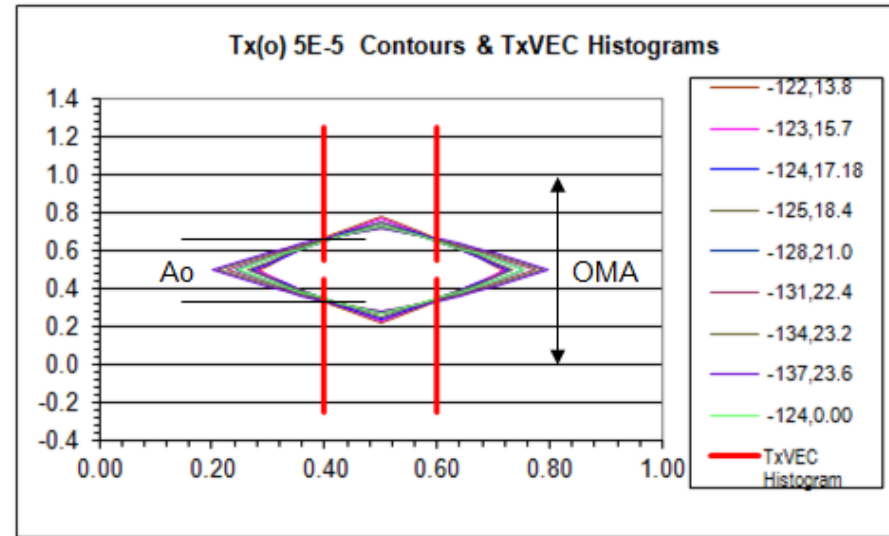

- TxVEC provides better results for MMF cases than TDP while using a simpler and friendlier test setup that is more likely to be adopted in the industry.
- The simpler and friendlier test requirements for TxVEC make it a preferable test even if TDP provided comparable results.
- 802.3bm should replace TDP with TxVEC.

New: 100G 100m SR4: A metric to replace TDP (5)

TDP Summary continued

• Since a TDP result is the difference between two optical Rx sensitivity measurement results, its accuracy and repeatability is driven by the accuracy and repeatability of optical Rx sensitivity measurements. Accuracy and repeatability of key attributes, such as TDP, are critical issues for operating life and other reliability tests where parametric drift is examined, setting tester guard bands and for correlating results between vendors and customers.

