

[Note: Material here is mostly adapted from D3.1 PHY I01 Section 7.5, some portions of other sections have been included, as noted. Some subsections have been omitted or modified based on existing P802.3bn Technical Decisions, are already covered in the PCS, are covered in other baseline material, or are T.B.D. that need to be brought in to a future P802.3bn meeting.]

[Note: the information in this document has not been separated into IEEE P802.3bn PHY sublayers.]

[Note: Copyediting is required to fix section, figure, and table numbers, etc. Expect an update before the Dallas meeting to fix section numbers and references.]

## **0.1 Abbreviations that might need to be added to EPoC:**

<b>dBc</b>	decibel carrier
<b>IDFT</b>	inverse discrete Fourier transform
<b>LLR</b>	log-likelihood ratio
<b>LTE</b>	long term evolution

## **1.1 Downstream Transmit and Receive**

### **1.1.1 Overview**

This section specifies the downstream electrical and signal processing requirements for the transmission of OFDM modulated RF signals from the CLT to the CNU.

This section is organized into subsections as summarized below:

#### **1.1.1 Overview**

Describes the structure of the EPoC Physical Layer (PHY) specification sub-section on CLT transmitter requirements and CNU receiver requirements.

#### **1.1.2 Signal Processing**

Informative description of the EPoC downstream channel signal processing including forward error correction, mapping of bits to constellation symbols, pilot insertion, Next Codeword Pointer insertion, interleaving, exclusion subcarrier insertion, PHY Link Channel insertion, inverse discrete Fourier transformation, pre-pending the cyclic prefix, and windowing.

#### **1.1.3 Time and Frequency Synchronization**

Defines CLT transmitter requirements for providing time and frequency references for downstream OFDM operation and CNU requirements for recovering and synchronizing to time and frequency references.

#### **1.1.4 Downstream Line Encoding and Forward Error Correction**

Defines CLT transmitter and CNU receiver requirements for forward error correction codeword creation, shortening, encoding, decoding and interleaving.

---

#### **1.1.5 Mapping Bits to QAM Constellations**

Defines CLT requirements for mapping serialized data bits from the FEC encoder to QAM constellations, bit stream demultiplexing, scrambling (randomization), mapping to constellations, bit loading, and inserting Next Codeword Pointers, and defines CNU and CLT modulation format requirements.

#### **1.1.6 Interleaving and De-interleaving**

Defines CLT requirements for time interleaving then frequency interleaving OFDM symbols and describes impacts of interleaving on pilots, PHY link channel and subcarrier excluded spectral regions. Defines CNU requirements for frequency and time de-interleaving.

#### **1.1.7 IDFT**

Defines CLT requirements for performing inverse discrete Fourier transform on the frequency-domain signal to be transmitted to CNU. Defines CNU requirements for performing discrete Fourier transform on the signal received from the CLT.

#### **1.1.8 Cyclic Prefix and Windowing**

Defines CLT requirements for inserting cyclic prefixes and applying windowing to the output of the IDFT and CNU requirements for processing cyclic prefixes.

#### **1.1.9 Fidelity Requirements**

Defines CLT transmitter requirements and limits for phase noise, modulation error ratio, spurious emissions, frequency accuracy, and modulation timing jitter.

#### **1.1.9 Fidelity Requirements**

Defines CLT transmitter requirements and limits for phase noise, modulation error ratio, spurious emissions, distortion, and noise,

#### **1.1.10 CLT Transmitter Output Requirements**

Defines CLT transmitter electrical output requirements including output power level, impedance, channel bandwidth and return loss.

#### **1.1.11 Cable Modem Receiver Input Requirements**

Defines CNU receiver input requirements including channel bandwidth, number of FFT blocks, bit loading, power level, impedance and return loss.

#### **1.1.12 Cable Modem Receiver Capabilities**

Defines CNU receiver capabilities and error ratio performance requirements.

#### **1.1.13 Physical Layer Link Channel (PLC)**

Defines requirements for the structure, preamble modulation, location, content, and forward error correction for the Physical Layer Link Channel.

#### **1.1.14 Next Codeword Pointer**

Defines requirements for bytes-to-bits mapping, forward error correction, FEC encoded bits to subcarriers mapping, subcarrier placement, and randomization for the Next Codeword Pointer.

---

### **1.1.15 Downstream Pilot Patterns**

Defines the structure of continuous and scattered pilots for downstream OFDM channels, describes the signaling of the pilot structure in the PLC, and defines CLT transmitter requirements for modulating and boosting the power of pilots.

## **1.2 Signal Processing**

Serial data signals received from the PHY-MAC Convergence Layer are received and processed by the PHY as illustrated in Figure 1–1. This process yields OFDM symbols with 4096 subcarriers for the 4K FFT mode and 8192 subcarriers for the 8K FFT mode, with each symbol consisting of:

- Data subcarriers
- Scattered pilots
- Continuous pilots
- PLC subcarriers
- Excluded subcarriers that are set to zero

This section briefly describes that process and provides links to the specific requirements for each process described in this specification.

Figure 1-1 - Downstream PHY Processing

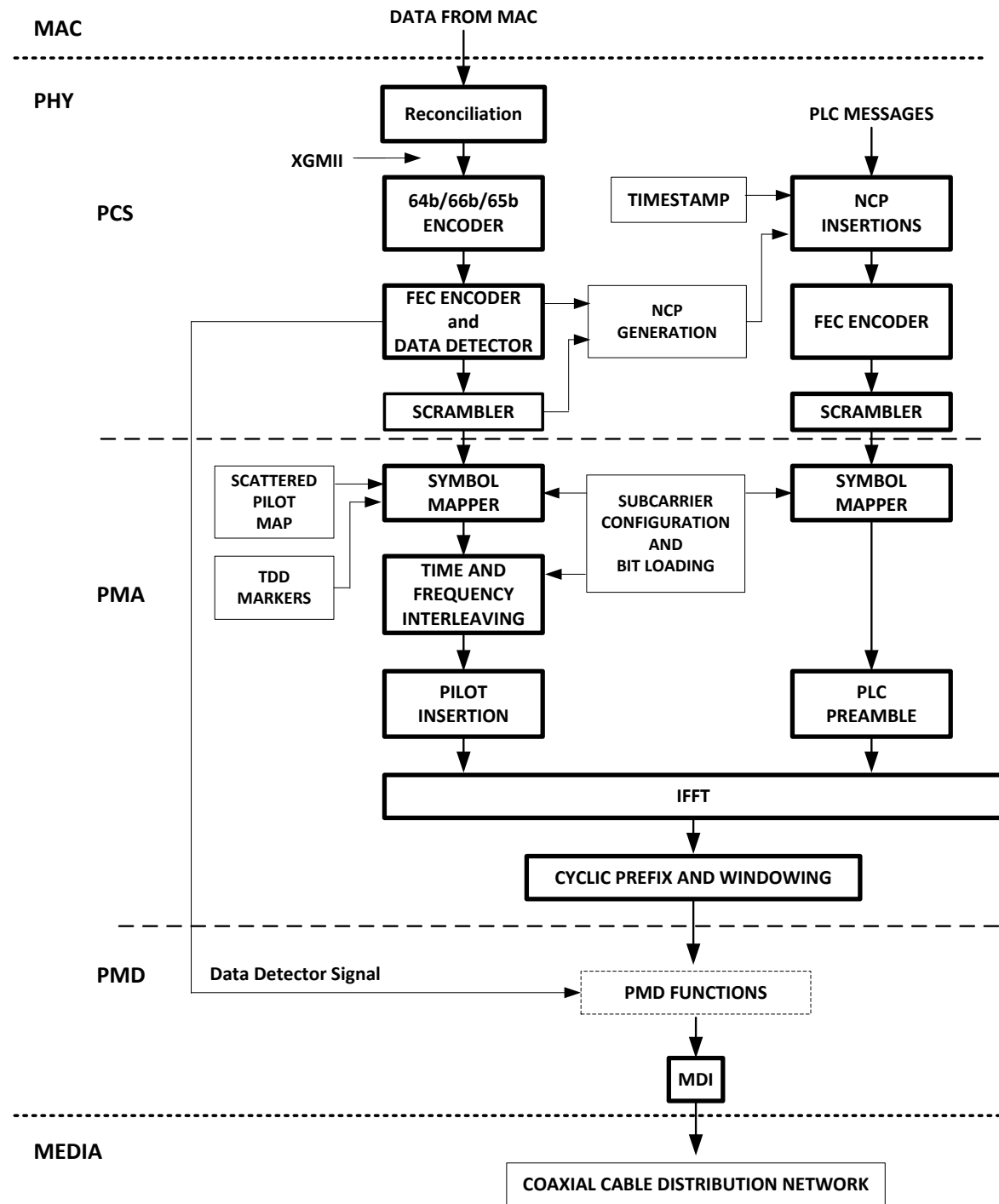

### **1.2.1 Forward Error Correction (FEC) Encoding and Data Detection**

The PHY begins processing incoming data by FEC encoding to data bits to form encoded codewords. Forward error correction adds redundancy to the transmitted data; these redundant bits can be used by the receiver to detect and correct errors in the transmission. For EPoC, FEC encoding applies an LDPC encoder, and then shuffling the bits in a codeword via bit interleaving. Downstream forward error correction is described in detail in Section 1.1.4.

#### **1.2.1.1 Symbol Mapping to QAM Constellations**

Once FEC encoded codewords have been created, the codewords are placed into OFDM symbols. Because each subcarrier in an OFDM symbol can have a different QAM modulation, the codewords must first be demultiplexed into parallel cell words; these cell words are then mapped into constellations based on the corresponding bit loading pattern of the subcarrier's QAM constellation. In EPoC, QAM constellations extend from 16-QAM to 4096-QAM (excluding 32-QAM), with both square and non-square constellations. This process is described in Section 1.1.5.

#### **1.2.1.2 Scattered Pilot Placeholder Insertion**

OFDM transmission requires the insertion of scattered pilots to enable channel estimation and equalization in the receiver. While the insertion happens after time and frequency interleaving, since these pilots are not in the same spectral location in every symbol, insertion of these scattered pilots disrupt the spectral location of the QAM data subcarriers. To overcome this problem, place-holders for scattered pilot locations are inserted during the symbol mapping process.

#### **1.2.1.3 Next Codeword Pointer Insertion**

Detecting where the next codeword begins in an OFDM symbol can be difficult: more than one codeword may map into one OFDM symbol, the number of codewords per OFDM symbol may not be an integer, a codeword can overflow from one OFDM symbol to another, and the codeword could be shortened. Therefore, the transmitter must convey to the receiver all of the locations where a new codeword begins within an OFDM symbol. These Next Codeword Pointers (NCPs) are encoded using another forward error correction method and are appended to OFDM symbols. The process of encoding and inserting the NCP for EPoC is discussed in Section 2.1.4.

#### **1.2.1.4 Interleaving**

These OFDM symbols, comprised of data subcarriers, scattered pilot placeholders, and NCPs, are then subjected to time and frequency interleaving. Time interleaving mitigates the impact of burst noise, while frequency interleaving mitigates the effect of ingress.

Time interleaving disperses the subcarriers of an input symbol over a set of output symbols, based on the depth of interleaving. Therefore, if an OFDM symbol is corrupted by a noise burst, this burst is spread over the symbols when it is de-interleaved, thereby reducing the error correction burden on the decoder. The time interleaving process is described in Section 1.1.6.

---

Frequency interleaving occurs after time interleaving. Frequency interleaving disperses subcarriers of the symbol along the frequency axis; therefore, OFDM subcarriers impacted by narrowband ingress are distributed between several codewords, reducing the number of errors in each codeword. The frequency interleaving process is described in Section 1.1.6.

#### **1.2.1.5 Insertion of Pilots and Exclusion Sub-Bands**

When interleaving is complete, placeholders for continuous pilots are inserted. These will be subject to modulation later, together with the placeholders already inserted for scattered pilots. Continuous pilots are pilots that occur at the same subcarrier location in every symbol. These are needed for receiver synchronization.

Exclusion bands and excluded subcarriers are inserted next. Nothing is transmitted at these subcarrier locations. The contiguous block of subcarriers allocated to the PHY Link Channel is also treated as an exclusion band at this stage; this is a placeholder for the PLC that is filled later. The regions outside the bandwidth of the OFDM signal may also be treated as exclusion bands.

Finally, the placeholders for scattered and continuous pilots are replaced with a BPSK pseudo-random sequence. This process is described in Section 1.1.15.

**[NOTE: following section from D3.1 PHY I01 Section 7.2.5.1]**

#### **1.2.1.6 Downstream Exclusion Band Rules**

- There has to be at least one contiguous modulated OFDM bandwidth of 22 MHz or greater, which will enable an OFDM channel bandwidth of 24 MHz including guardbands.
  - Exclusion bands separate contiguous modulation bands.
  - The minimum contiguous modulation band has to be 2 MHz.
  - Exclusion bands and individually excluded subcarriers are common to all downstream profiles.
  - Exclusion bands are a minimum of 1 MHz but increment above 1 MHz by granularity of individual subcarrier (25 kHz for 8k FFT and 50 kHz for 4K FFT).
  - Exclusion bands plus individually excluded subcarriers are limited to 20% or less of spanned modulation spectrum, where the spanned modulation spectrum is defined as: frequency of maximum active subcarrier – frequency of minimum active subcarrier.
  - The number of individually excluded subcarriers is limited by the following:
    - The total spectrum of individually excluded subcarriers cannot exceed 5% of any contiguous modulation spectrum.
    - The total spectrum of individually excluded subcarriers cannot exceed 5% of a 6 MHz moving window across the contiguous modulation spectrum.
    - The total spectrum of individually excluded subcarriers cannot exceed 20% of a 1 MHz moving window across the contiguous modulation spectrum.
  - The 6 MHz of contiguous spectrum reserved for the PLC cannot have any exclusion bands or excluded subcarrier.
-

### **1.2.1.7 Encoding and Insertion of the PLC**

The PLC is constructed within the PCS in parallel with the functions already discussed, relating to the main data channel. The PLC occupies the same contiguous set of subcarriers in every OFDM symbol. The PLC data is encoded for error correction, and then mapped into 16-QAM PLC data subcarriers. The PLC data is not subjected to the same time or frequency interleaving as the data; however they are block interleaved. The PLC is then inserted in place of its placeholder in each symbol. This process is described in Section 1.1.6.3.

### **1.2.1.8 IDFT Transformation and Cyclic Prefix Insertion**

In this stage each OFDM symbol is transformed into the time domain using a 4096-point or 8192-point inverse discrete Fourier transform (IDFT). This 4096 or 8192 sample sequence is referred to below as the IDFT output. This process is described in Section 1.1.7.

### **1.2.1.9 Cyclic Prefix and Windowing**

A segment at the end of the IDFT output is prepended to the IDFT, and this is referred to as the Cyclic Prefix (CP) of the OFDM symbol. There are five possible values for the length of the CP and the choice depends on the delay spread of the channel – a longer delay spread requires a longer cyclic prefix.

For windowing purposes another segment at the start of the IDFT output is appended to the end of the IDFT output – the roll-off postfix (RP). There are five possible values for the RP, and the choice depends on the bandwidth of the channel and the number of exclusion bands within the channel. A larger RP provides sharper edges in the spectrum of the OFDM signal; however, there is a time vs. frequency trade-off. Larger RP values reduce the efficiency of transmission in the time domain, but because the spectral edges are sharper, more useful subcarriers appear in the frequency domain. There is an optimum value for the RP that maximizes capacity for a given bandwidth and/or exclusion band scenario.

These topics are discussed in detail in Section 1.1.8.

## **1.2.2 Time and Frequency Synchronization**

This section specifies the timing and frequency synchronization requirements for EPoC CLT transmitters and CNU receivers.

The purpose of this section is to ensure that the CLT transmitter can provide proper timing and frequency references for EPoC downstream OFDM operation and that the CNU receiver can acquire the system timing and subcarrier from the downstream for proper EPoC operation.

The CLT downstream OFDM symbol and subcarrier frequency and timing relationship is defined in Section 1.2.2.3.

---

**1.2.2.1 Downstream sampling rate**

The CLT MUST lock the 204.8 MHz Downstream OFDM Clock to the 10.24 MHz CLT Master Clock (see Table 1-1).

**[Note: following section and table from D3.1 PHY I01 Section 7.3.1]**

**1.2.2.2 OFDM RF Transmission Synchronization**

The CLT MUST lock the Downstream OFDM RF transmissions to the 10.24 MHz CLT Master Clock (see Table 1-1).

**Table 1-1 - Downstream OFDM parameters**

Parameter	4K mode	8K mode
Downstream master clock frequency	10.24 MHz	
Downstream Sampling Rate (fs)	204.8 MHz	
Downstream Elementary Period (Tsd)	1/(204.8 MHz)	
Channel bandwidths	24 MHz ... 192 MHz	
Minimum contiguous bandwidth*	6 MHz	
IDFT size	4096	8192
Subcarrier spacing	50 kHz	25 kHz
FFT duration (Useful symbol duration) (Tu)	20 μs	40 μs
Number of active subcarriers in signal (192 MHz channel) Values refer to 190 MHz of used subcarriers.	3801	7601
Spacing between first and last active subcarrier	190 MHz	
Cyclic Prefix	0.9375 μs (192 * T <sub>sd</sub> ) 1.25 μs (256 * T <sub>sd</sub> ) 2.5 μs (512 * T <sub>sd</sub> ) 3.75 μs (768 * T <sub>sd</sub> ) 5 μs (1024 * T <sub>sd</sub> )	
Windowing	Tukey raised cosine window, embedded into cyclic prefix 0 μs (0 * T <sub>sd</sub> ) 0.15625 μs (32 * T <sub>sd</sub> ) 0.3125 μs (64 * T <sub>sd</sub> ) 0.625 μs (128 * T <sub>sd</sub> ) 0.9375 μs (192 * T <sub>sd</sub> ) 1.25 μs (256 * T <sub>sd</sub> )	

**[Note: following section is from D3.1 PHY I01 Section 7.3.3]**

**1.2.2.3 Subcarrier Clocking**

The "locking" of subcarrier "clock and carrier" are defined and characterized by the following rules:

- Each OFDM symbol is defined with a Subcarrier Clock frequency of nominally 20 usec or 40 usec. For each OFDM symbol, the Subcarrier Clock period (us) may vary from nominal with limits defined in Section 7.5.3.
  - The number of cycles of each subcarrier generated by the CLT during one period of the Subcarrier Clock (for each OFDM symbol) MUST be an integer number.
-



- The CLT Subcarrier Clock MUST be synchronous with the 10.24 MHz Master Clock defined by:  
Subcarrier Clock frequency =  $(M/N) \times \text{Master Clock frequency}$  where  $M = 20$  or  $40$ , and  $N = 8192$
- The limitation on the variation from nominal of the Subcarrier Clock frequency at the output connector is defined in Section 7.5.3.
- Each OFDM symbol has a cyclic prefix which is an integer multiple of  $1/64^{\text{th}}$ , of the Subcarrier Clock period.
- Each OFDM symbol duration is the sum of one Subcarrier Clock period and the cyclic prefix duration.
- The number of cycles of each subcarrier generated by the CLT during the OFDM symbol duration (of each symbol) MUST be  $K+K \times L/64$ , where  $K$  is an integer related to the subcarrier index and frequency upconversion of the OFDM channel, and  $L$  is an integer related to the cyclic prefix. ( $K$  is an integer related to the subcarrier index and increases by 1 for each subcarrier).
- The phase of each subcarrier within one OFDM symbol is the same, when each is assigned the same constellation point ( $I + jQ$ ), relative to the Reference Time of the OFDM symbol. There is nominally no change in phase on each subcarrier for every cycle of 64 OFDM symbols, when both are assigned the same  $I + jQ$ , and referenced to the Reference Time of their respective OFDM symbol.

### **1.2.2.4 Downstream OFDM Symbol Clock Jitter**

The CLT MUST adhere to the following double sideband phase noise requirements for the downstream OFDM symbol clock over the specified frequency ranges:

- $< [-21 + 20 \times \log(f_{DS}/204.8)]$  dBc (i.e.,  $< 0.07$  nSec RMS) 10 Hz to 100 Hz
- $< [-21 + 20 \times \log(f_{DS}/204.8)]$  dBc (i.e.,  $< 0.07$  nSec RMS) 100 Hz to 1 kHz
- $< [-21 + 20 \times \log(f_{DS}/204.8)]$  dBc (i.e.,  $< 0.07$  nSec RMS) 1 kHz to 10 kHz
- $< [-4 + 20 \times \log(f_{DS}/204.8)]$  dBc (i.e.,  $< 0.5$  nSec RMS) 10 kHz to 100 kHz
- $< [2 + 20 \times \log(f_{DS}/204.8)]$  dBc (i.e.,  $< 1$  nSec RMS) 100 kHz to  $(f_{DS}/2)$ ,

where  $f_{DS}$  is the frequency of the measured clock in MHz.

The CLT MUST use a value of  $f_{DS}$  that is an integral multiple or divisor of the downstream symbol clock. For example, an  $f_{DS} = 409.6$  MHz clock may be measured if there is no explicit 204.8 MHz clock available.

### **1.2.2.5 Downstream Timing Acquisition Accuracy**

The downstream clock timing is defined with respect to downstream OFDM frame.

The CNU MUST be able to adjust its clock to synchronize its own clock timing with OFDM downstream frame for proper operation.

The CNU MUST be able to acquire downstream clock timing from downstream traffic (pilots, preambles, or mixed pilots, preambles, and data).

The CNU MUST have a timing acquisition accuracy better than 1 sample (4.8828125 ns).

---

### 1.2.2.6 Downstream Carrier Frequency Acquisition Accuracy

The CNU MUST be able to acquire the carrier frequency from downstream (pilots, preambles, or mixed pilots, preambles and data).

### 1.2.2.7 Downstream Acquisition Time

The CNU MUST achieve downstream signal acquisition (frequency and time lock) in less than 60s for a device with no previous network frequency plan knowledge.

In other cases it is expected that the CNU would be able to achieve downstream acquisition in less than 30s.

## 1.2.3 Downstream Line Encoding and Forward Error Correction

**[NOTE: this section of the PCS is already substantially complete.]**

## 1.2.4 Mapping Bits to QAM Constellations

This section describes the method used in EPoC to map symbols onto QAM constellations.

**[NOTE: need to supply replacement overview [?]]**

The mapping of bits to QAM constellation is carried out using the three sequential operations depicted in *Figure 1–2*.

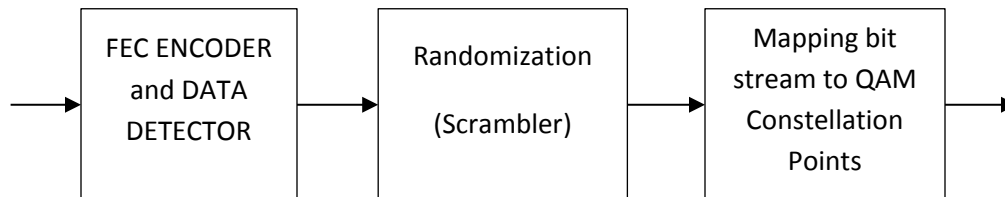

**Figure 1–2 - Bits to QAM Constellation Mapping**

### 1.2.4.4 Randomization - Scrambler

**[NOTE: scrambler specification, initialization, and synchronization is T.B.D.]**

### 1.2.4.5 Bit Stream into I/Q Constellations

The CLT MUST modulate the output of randomizer bit stream described in Section 1.1.5.1 using a BPSK, QPSK, 16-QAM, 64-QAM, 128-QAM, 256-QAM, 512-QAM, 1024-QAM, 2048-QAM, 4096-QAM, 8192-QAM or 16384-QAM constellation as described in Section **Error! Reference source not found..**

---

#### 1.2.4.6 Transmitter Bit Loading for Symbol Mapping

All subcarriers of an OFDM symbol may not have the same constellation; the constellation for each subcarrier is given in a table that details the bit loading pattern. This bit-loading pattern may change from profile to profile. This section describes how the bits to symbol mapping is performed, with reference to a bit-loading pattern, in the presence of interleaving, continuous pilots, scattered pilots and excluded subcarriers.

Excluded subcarriers are subcarriers that are forced to zero-valued modulation at the transmitter. Subcarriers are excluded to prevent interference to other transmissions that occupy the same spectrum as the EPoC OFDM transmission, for example, to accommodate legacy channels. Subcarriers are also excluded outside of the active OFDM bandwidth.

Excluded subcarriers are common to all profiles. The non-excluded subcarriers are referred to as active subcarriers. Active subcarriers are never zero-valued. The notation  $S^{(E)}$  is used here to define the set of excluded subcarriers. This set will never be empty because there are always excluded subcarriers at the edges of the OFDM channel.

Continuous pilots are pilots that occur at the same frequency location in every OFDM symbol. The notation  $S^{(C)}$  is used here to define the set of continuous pilots.

The PLC resides in a contiguous set of subcarriers in the OFDM channel. The CLT adds the PLC to the OFDM channel after time and frequency interleaving; the CNU extracts the PLC subcarriers before frequency and time de-interleaving. These subcarriers occupy the same spectral locations in every symbol. The notation  $S^{(P)}$  is used here to define the set of PLC subcarriers.

For bit loading, continuous pilots and the PLC are treated in the same manner as excluded subcarriers; hence, the set of subcarriers that includes the PLC, continuous pilots and excluded subcarriers is defined as:

$$S^{(PCE)} = S^{(P)} \cup S^{(C)} \cup S^{(E)}$$

The subcarriers in the set  $S^{(PCE)}$  do not carry data (PLC carry signaling information). The other subcarriers that do not carry data are the scattered pilots. However, scattered pilots are not included in the set  $S^{(PCE)}$  because they do not occupy the same spectral locations in every OFDM symbol.

The modulation order of the data subcarriers is defined using a bit-loading profile. This profile includes the option for zero bit-loading. Such subcarriers are referred to as zero-bit-loaded subcarriers and are BPSK modulated using the randomizer LSB, as described in Section 1.1.5.1.

All active subcarriers with the exception of pilots are transmitted with the same average power. Pilots are transmitted boosted by a factor of 2 in amplitude (approximately 6 dB).

---

Scattered pilots do not occur at the same frequency in every symbol; in some cases scattered pilots will overlap with continuous pilots. If a scattered pilot overlaps with a continuous pilot, then that pilot is no longer considered to be a scattered pilot. It is treated as a continuous pilot.

Because the locations of scattered pilots change from one OFDM symbol to another, the number of overlapping continuous and scattered pilots changes from symbol to symbol. Since overlapping pilots are treated as continuous pilots, the number of scattered pilots changes from symbol to symbol.

The following notation is used here:

$N$ : The total number of subcarriers in the OFDM symbol, equaling either 4096 or 8192

$N_C$ : The number of continuous pilots in an OFDM symbol

$N_S$ : The number of scattered pilots in an OFDM symbol

$N_E$ : The number of excluded subcarriers in an OFDM symbol

$N_P$ : The number of PLC subcarriers in an OFDM symbol

$N_D$ : The number of data subcarriers in an OFDM symbol

The values of  $N$ ,  $N_C$ ,  $N_E$  and  $N_P$  do not change from symbol to symbol for a given OFDM template; the values of  $N_S$  and  $N_D$  change from symbol to symbol.

The following equation holds for all symbols:

$$N = N_C + N_S + N_E + N_P + N_D$$

The value of  $N$  is 4096 for 50 kHz subcarrier spacing and 8192 for 25 kHz subcarrier spacing. From this equation it is clear that  $(N_S + N_D)$  is a constant for a given OFDM template. Therefore, although the number of data subcarriers ( $N_D$ ) and the number of scattered pilots ( $N_S$ ) in an OFDM symbol changes from symbol to symbol, the sum of these two numbers is invariant over all symbols. Interleaving and de-interleaving are applied to the set of data subcarriers and scattered pilots of size  $N_I = N_D + N_S$ .

#### 1.2.4.6.1 Bit Loading

The bit loading pattern defines the QAM constellations assigned to each of the 4096 or 8192 subcarriers of the OFDM transmission. This bit loading pattern can change from profile to profile. Continuous pilot locations, PLC locations and exclusion bands are defined separately, and override the values defined in the bit-loading profile. Let the bit loading pattern for profile  $i$  be defined as  $A_i(k)$ , where:

$k$  is the subcarrier index that goes from 0 to  $(N-1)$

$N$  is either 4096 or 8192

$A_i(k) \in \{0, 4, 6, 7, 8, 9, 10, 11, 12, 13, 14\}$ . A value of 0 indicates that the subcarrier  $k$  is zero-bit-loaded. Other values indicate that the modulation of subcarrier  $k$  is QAM with order  $2^{A_i(k)}$ .

---

Let the sequence  $\{A_i(k), k = 0, 1, \dots, (N - 1), k \notin S^{PCE}\}$  be arranged as  $N_I$  consecutive values of another sequence:

$$B_i(k), k = 0, 1, \dots, (N_I - 1)$$

Given the locations of the excluded subcarriers, continuous pilots and the PLC in the OFDM template, it is possible to obtain the bit-loading pattern  $B_i(k)$  that is applicable only to spectral locations excluding excluded subcarriers, continuous pilots, and PLC subcarriers. However, note that  $B_i(k)$  does contain the spectral locations occupied by scattered pilots; these locations change from symbol to symbol.

It is more convenient to define bit loading profiles in the domain in which subcarriers are transmitted. It is in this domain that signal-to-noise-ratios of subcarriers are calculated. Furthermore, defining the bit-loading patterns in the transmission domain allows significant data compression to be achieved, because a relatively large number of contiguous spectral locations can share the same QAM constellation.

Although the bit loading pattern is defined in the domain in which subcarriers are transmitted, the bit loading is not applied in that domain. Bit loading is applied prior to interleaving, as shown in Figure Error! No text of specified style in document.–3. Hence there is a permutation mapping of subcarriers, defined by the interleaving function, between the domain in which bit loading is applied to subcarriers and the domain in which subcarriers are transmitted.

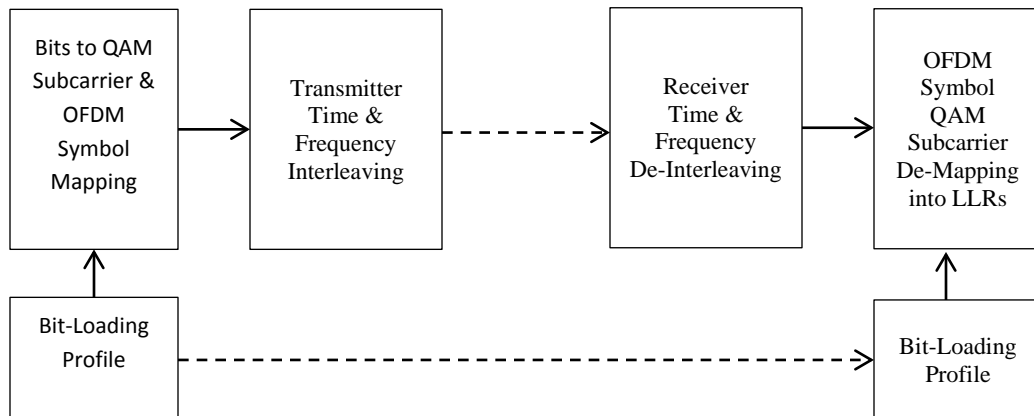

**Figure 1–3 - Bit Loading, Symbol Mapping, and Interleaving**

The excluded subcarriers, PLC subcarriers, and continuous pilots are excluded from the processes of interleaving and de-interleaving; scattered pilots and data subcarriers are subject to interleaving and de-interleaving. Hence, the total number of subcarriers that pass through the interleaver and de-interleaver is  $N_I = (N_D + N_S)$  and this number does not change from symbol to symbol.

The interleaver introduces a 1-1 permutation mapping  $P$  on the  $N_I$  subcarriers. Although interleaving consists of a cascade of two components, namely time and frequency interleaving, it is only frequency

---

interleaving that defines the mapping  $P$ . This is because time interleaving does not disturb the frequency locations of subcarriers.

The corresponding permutation mapping applied at the receiver de-interleaver is  $P^{-1}$ .

In order to perform bit-loading, it is necessary to work out the bit loading pattern at the node at which it is applied, i.e., at the input to the interleavers. This is given by:

$$C_i(k) = P^{-1}(B_i(k))$$

Since the time interleaver does not change the frequency locations of subcarriers, the sequence  $C_i(k)$  is obtained by sending  $\{B_i(k), k = 1, 2, \dots, N_I - 1\}$  through the frequency de-interleaver.

Note that  $C_i(k)$  gives the bit-loading pattern for  $N_I$  subcarriers. Yet, some of these subcarriers are scattered pilots that have to be avoided in the bit-loading process. Hence, a two-dimensional binary pattern  $D(k, j)$  is used to identify subcarriers to be avoided during the process of bit-loading. Because the scattered pilot pattern has a periodicity of 128 in the time dimension, this binary pattern also has periodicity 128 in the column dimension  $j$ .

$D(k, j)$  is defined for  $k = 0, 1, \dots, (N_I - 1)$  and for  $j = 0, 1, \dots, 127$

The process to create the binary pattern  $D(k, j)$  begins with the transmitted scattered pilot pattern defined in Section 1.1.6. There are two scattered pilot patterns, one for 4K FFTs and the other for 8K FFTs; both patterns are defined in reference to the preamble of the PLC and have a periodicity of 128 symbols.

The CLT executes the following steps to obtain the pattern  $D(k, j)$ :

1. Define a two-dimensional binary array  $P(k, j)$  in the subcarrier transmitted domain that contains a one for each scattered pilot location and zero otherwise:

$P(k, j)$ , for  $k = 0, 1, \dots, N - 1$  and for  $j = 0, 1, \dots, 127$

Here, the value of  $N$  is either 4096 or 8192. The first column of this binary sequence corresponds to the first OFDM symbol following the preamble of the PLC.

2. Exclude the rows corresponding to excluded subcarriers, continuous pilots, and PLC from the two-dimensional array  $P(k, j)$  to give an array  $Q(k, j)$ . The number of rows of the resulting array is  $N_I$  and the number of columns is 128.
  3. Pass this two-dimensional binary array  $Q(k, j)$  through the frequency de-interleaver and then the time de-interleaver, with each column treated as an OFDM symbol. After the 128 columns of the pattern have been input into the interleaver, re-insert the first  $M$  columns, where  $M$  is the depth of the time interleaver. This is equivalent to periodically extending  $Q(k, j)$  along the dimension  $j$  and passing  $(128+M)$  columns of this extended sequence through the frequency de-interleaver and the time de-interleaver.
-

4. Discard the first  $M$  symbols coming out of the time de-interleaver and collect the remaining 128 columns into an array to give the binary two-dimensional array  $D(k, j)$  of size  $(N_I \times 128)$ .

For bit loading the CLT accesses the appropriate column  $j$  of the binary pattern bit  $D(k, j)$  together with the appropriate bit loading profile  $C_i(k)$ . If the value of the bit  $D(k, j)$  is 1, the CLT MUST skip this subcarrier  $k$  and move to the next subcarrier. This subcarrier is included as a placeholder for a scattered pilot that will be inserted in this subcarrier location after interleaving. After each symbol the column index  $j$  has to be incremented modulo 128.

The CLT MUST use this binary two-dimensional array  $D(k, j)$  of size  $(N_I \times 128)$  in order to do bit-loading of OFDM subcarriers, as described earlier in this section.

The corresponding operation in the CNU is de-mapping the QAM subcarriers to get Log-Likelihood-Ratios (LLRs) corresponding to the transmitted bits. This operation, described below, is much simpler than the mapping operation in the transmitter.

The scattered pilots and data subcarriers of every received symbol are subjected to frequency and time de-interleaving. The scattered pilots have to be tagged so that these can be discarded at the output of the time and frequency de-interleavers. This gives  $N_I$  subcarriers for every OFDM symbol. The CNU accesses these  $N_I$  de-interleaved subcarriers together with the bit-loading pattern  $C_i(k)$  to implement the de-mapping of the QAM subcarriers into LLRs. If the subcarrier  $k$  happens to be a scattered pilot, then this subcarrier, as well as the corresponding value  $C_i(k)$ , is skipped and the CNU moves to the next subcarrier  $(k + 1)$ .

#### 1.2.4.6.2 NCP Insertion

Next Codeword Pointers (NCPs) point to the beginning of codewords in a symbol, counting only data subcarriers. The format of an NCP is described in Section 2.1.4, **Next Codeword Pointer**, which also describes the FEC applied to the NCP. Each FEC encoded NCP is 48 bits wide. NCPs may be modulated using QPSK, 16-QAM or 64-QAM and this modulation is signaled by PLC. In addition to the NCPs carrying next codeword pointers, there will also be a NCP carrying the CRC for all the NCPs of the symbol. The CRC is generated as described in section 2.3.4.2. For 8K FFT node, there will be NCPs in each symbol. For the 4K FFT, there will be one set of NCPs per pair of symbols.

As the NCPs are constructed while the OFDM symbols are being constructed, the NCPs are inserted in the opposite direction to data and beginning from the opposite end. Data is inserted beginning from the low frequency towards the high frequency end. The NCPs are inserted from the high frequency end towards the low frequency end.

Note that  $N_I$  subcarriers in each symbol are subjected to the data and NCP mapping operation. These subcarriers consist of data subcarriers and scattered pilot place-holder subcarriers as described in the preceding section. During the course of mapping data or NCP subcarriers, if a scattered pilot placeholder is encountered, this is skipped.

---

The figure given below shows an OFDM symbol comprising a Data segment, an NCP segment and a "Filler" segment. "Filler" subcarriers have to be inserted into the OFDM symbol when there is no data to be transmitted, or when the number of codewords has exceeded the upper limit or when it is not possible to begin a new codeword because of insufficient space to include a NCP. These filler subcarriers are zero-bit-loaded.

The CLT MUST use zero-bit-loaded filler subcarriers when there is no data to be transmitted or when the number of codewords has exceeded the upper limit or when it is not possible to begin a new codeword because of insufficient space to include a NCP.

Data segment contains codewords belonging to several profiles. Some of the subcarriers may be zero-bit-loaded in some of the profiles. The NCP also has a profile. This profile allows some of the subcarriers in the NCP segment to be zero-bit-loaded. Note that the NCP modulation is a constant for given OFDM transmission. It does not change from subcarrier to subcarrier.

Note that throughout the symbol there can be scattered pilot placeholders. These have to be skipped during the insertion of data subcarriers, NCP subcarriers or filler subcarriers. Moreover, these have to be tagged before sending the  $N_i$  subcarriers through the time and frequency interleavers. Scattered pilots will be inserted in their place with the appropriate BPSK modulation before the data is transmitted.

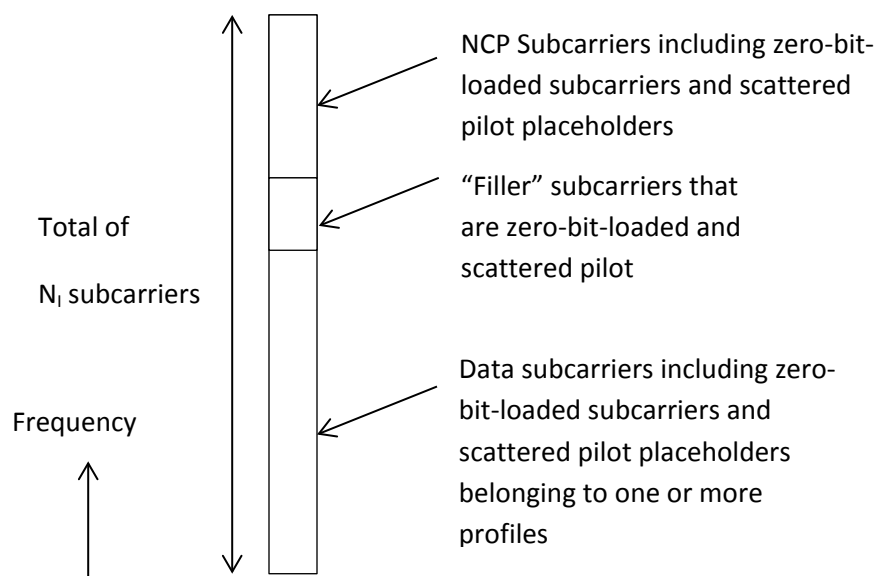

**Figure 1–4 - NCP Insertion**

---



### 1.2.5 Interleaving and De-interleaving

To minimize the impacts of burst noise and ingress on the EPOC signals, time and frequency interleaving are applied to OFDM symbols in the following order: time interleaving, then frequency interleaving. These interleaving methods are discussed in this section.

The time interleaver is a convolutional interleaver that operates in the time dimension on individual subcarriers of a sequence of OFDM symbols. The time interleaver does not change the frequency location of any OFDM subcarrier. A burst event can reduce the SNR of all the subcarriers of one or two consecutive OFDM symbols; the purpose of the time interleaver is to disperse these burst-affected OFDM subcarriers between  $M$  successive OFDM symbols, where  $M$  is the interleaver depth. This dispersion distributes the burst-affected subcarriers uniformly over a number of LDPC codewords.

The frequency interleaver works along the frequency dimension. The frequency interleaver changes the frequency locations of individual OFDM subcarriers; latency is not introduced, except for the data store and read latency. The aim of frequency interleaving is to disperse ingress, e.g., LTE that affects a number of consecutive subcarriers over the entire OFDM symbol. Frequency interleaving distributes the burst-affected subcarriers over a number of LDPC codewords.

The CLT first applies a time interleaver to an OFDM symbol worth of  $N_I$  subcarriers to get a new set of  $N_I$  subcarriers. These  $N_I$  subcarriers are made up of  $N_D$  data subcarriers and  $N_S$  scattered pilots.

$$N_I = N_D + N_S$$

It must be noted that although  $N_D$  and  $N_S$  are not the same for every OFDM symbol, the value of  $N_I$  is a constant for all OFDM symbols in a given system configuration. The value of  $N_I$  is a function of the channel bandwidth, number of excluded subcarriers, number of PLC subcarriers and the number of continuous pilots. The CLT then subjects these  $N_I$  subcarriers to frequency interleaving. The value of  $N_I$  does not exceed 7537 for 8K FFT mode and 3745 for the 4K FFT mode.

Note that both time and frequency interleaving are applied only to data subcarriers and scattered pilots. Continuous pilot, subcarriers that have been excluded (used to support legacy channels in spectral regions, for example) and the subcarriers of the physical layer link channel (PLC) are not interleaved. The CLT MUST NOT interleave continuous pilots, excluded subcarriers or the subcarriers of the PLC.

#### 1.2.5.4 Time Interleaving

The CLT MUST time interleave as described in this section. The CLT MUST time interleave after OFDM symbols have been mapped to QAM constellations and before they are frequency interleaved.

The time interleaver is a convolutional interleaver that operates at the OFDM subcarrier level. If the depth of the interleaver is  $M$ , then there are  $M$  branches, as shown in Figure Error! *No text of specified style in document.*–5.

---

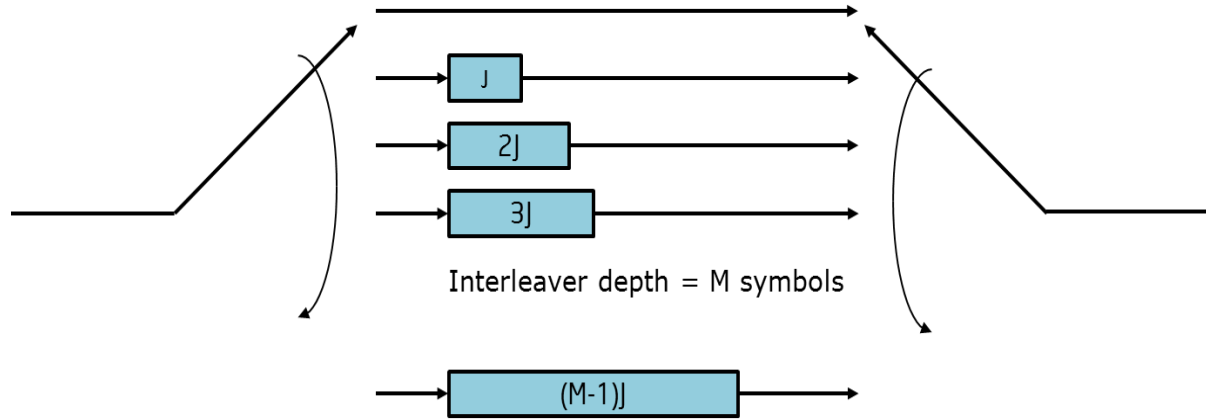

**Figure Error! No text of specified style in document.-5 - Time Interleaver Structure**

The CLT MUST support a maximum value of M equal to 32 for 20 μs symbol duration (50 kHz subcarrier spacing) and 16 for 40 μs symbol duration (25 kHz subcarrier spacing).

The CLT MUST support all values of M from 1 to the maximum value of M (inclusive of both limits).

Each branch is a delay line; the input and output will always be connected to the same delay line. This delay line will be clocked to insert a new subcarrier into the delay line and to extract a subcarrier from the delay line. Next, the commutator switches at the input, and the output will move to the next delay line in the direction shown by the arrows in Figure 1–1. After the delay line with the largest delay, the switch will move to the delay line with zero delay.

The lowest frequency subcarrier of an OFDM symbol always goes through the branch with zero delay. Then the commutator switch at input and the corresponding commutator switch at output are rotated by one position for every new subcarrier.

The value of J is given by the following equation:

$$J = \text{ceil}\left(\frac{N_I}{M}\right)$$

Here,  $N_I$  is the number of data subcarriers and scattered pilots in an OFDM symbol. See Section 1.1.6.3 for details on interleaving scattered pilots.

If  $N_I$  were not divisible by  $M$ , all of the branches would not be filled. Therefore, "dummy subcarriers" are added to the symbol to make the number of subcarriers equal to a multiple of  $M$ . The number of dummy subcarriers is given by:

$$J * M - N_I$$

---

The dummy subcarriers are added for definition purposes only; at the output of the interleaver these dummy subcarriers are discarded. An implementation will use a single linear address space for all the delay lines in Figure 1–1. Writing and reading dummy subcarriers will not be needed.

#### **1.2.5.5 Frequency Interleaving**

**[Note: this section is T.B.D.]**

#### **1.2.5.6 Interleaving Impact on Continuous Pilots, Scattered Pilots, PLC and Excluded Spectral Regions**

EPoC transmissions contain continuous pilots for receiver synchronization and scattered pilots for channel estimation. In addition, there could be nulled regions to accommodate legacy channels. There will also be a physical layer link channel (PLC).

The CLT interleaves scattered pilots and data subcarriers, but does not interleave continuous pilots, the PLC, and subcarriers belonging to nulled regions. With respect to scattered pilots, it must be noted here that CLT actually interleaves the subcarriers that are tagged to act as placeholders for scattered pilots, since at the time of interleaving the scattered pilots have not yet been inserted. The actual BPSK modulation to these placeholder subcarriers is applied after interleaving as described in Section 1.1.15.

The CLT inserts scattered pilot placeholders prior to time and frequency interleaving such that when these placeholders get time and frequency interleaved, the resulting placeholders conform to the required scattered pilot pattern described in Section 1.1.15.

To accomplish this, the CLT has to retain a reference pattern for inserting scattered pilot placeholders prior to interleaving. Since the scattered pilot pattern repeats every 128 symbols, this pattern is a  $(N_s \times 128)$  two-dimensional bit pattern. A value of one in this bit-pattern indicates the location of a scattered pilot. The CLT inserts data subcarriers where this reference pattern has a zero and scattered pilot placeholders where this pattern has a one.

This reference pattern may be derived from the following procedure:

1. In the time-frequency plane, create a two-dimensional bit-pattern of zeros and ones from the transmitted "diagonal" scattered pilot patterns described in Section 1.1.15. This pattern has a periodicity of 128 symbols and has a value of one for a scattered pilot location and zero otherwise. Let the time axis be horizontal and the frequency axis vertical.
  2. Delete all horizontal lines containing continuous pilots, excluded subcarriers, and PLC from the above mentioned two-dimensional bit pattern; note the some scattered pilots could coincide with continuous pilots. These locations are treated as continuous pilot locations.
  3. Send the resulting bit-pattern through the frequency de-interleaver and the time de-interleaver in succession. This will give another two-dimensional bit pattern that has a periodicity of 128 symbols. The appropriate 128-symbol segment of this bit-pattern is chosen as the reference bit pattern referred to above.
-

Note that the CLT has to synchronize the scattered pilot pattern to the PLC preamble, as described in Section 1.1.15. This uniquely defines the 128-symbol segment that has to be used as the reference pattern.

Scattered pilots are not in the same subcarrier location in every symbol; hence some scattered pilots can coincide with continuous pilots in some OFDM symbols. The size of the overlap between the set of scattered pilots and the set of continuous pilots will change from symbol to symbol. As a result, the number of data subcarriers in a symbol will not be the same for all OFDM symbols. Note that in the nomenclature used below, when a scattered pilot coincides with a continuous pilot, then that pilot is referred to as a continuous pilot.

Although the number of data subcarriers can change from symbol to symbol, the number of data subcarriers and scattered pilots are the same for every symbol. This is referred to as  $N_I$  in this section. Let  $N_D$  denote the number of data subcarriers in a symbol and  $N_S$  denote the number of scattered pilots in a symbol. These two parameters, i.e.,  $N_D$  and  $N_S$ , will change from symbol to symbol. However, the sum of these two, i.e.,  $N_I$  is a constant for a given system configuration.

$$N_I = N_S + N_D$$

Hence the number of OFDM subcarriers that are interleaved does not change from symbol to symbol. This is important, because if not for this, the output of the convolutional time interleaver may have dummy or unused subcarriers in the middle of interleaved OFDM symbols.

The insertion of continuous pilots, PLC and excluded regions happens after both time and frequency interleaving.

Interleaving data and scattered pilots together has another important advantage. This is to do with bit loading. A transmitted profile is said to have non-uniform bit loading if the QAM constellation that is applied to subcarriers is not constant over the entire frequency band. If the data subcarriers are interleaved and scattered pilots are added later, then the data subcarriers will have to be shifted to accommodate the scattered pilots. This shift will be different from symbol to symbol, and this complicates non-uniform bit-loading. Hence, having the scattered pilots in-place during the bit-loading process greatly simplifies the bit loading operation. The insertion of continuous pilots, PLC and nulled regions also results in shift of data subcarriers, but this shift is the same for every symbol, and can easily be accounted for in the bit loading process.

The CLT only interleaves data subcarriers and scattered pilots, and therefore only needs information about the number of data subcarriers and scattered pilots per symbol. In addition, the interleaver does not need to know what modulation has been applied to an individual data subcarrier. Regardless of modulation scheme, all OFDM symbols will have the same number of data subcarriers and scattered pilots, and the modulation pattern of these data subcarriers may change from symbol to symbol.

---

## 1.2.6 IDFT

### 1.2.6.4 Downstream Transmitter Inverse Discrete Fourier Transform

The CLT transmitter MUST use the IDFT definition and subcarrier referencing method described in this section.

This section defines the inverse discrete Fourier transform (IDFT) used in the CLT transmitter for EPoC. OFDM subcarrier referencing for other definitions such as PLC location, continuous pilots, exclusion bands and bit loading is also described.

The OFDM signal assembled in the frequency domain consists of 4096 subcarriers for the 4K FFT and 8192 subcarriers for the 8K FFT. The OFDM signal is composed of:

- Data subcarriers
- Scattered pilots
- Continuous pilots
- PLC subcarriers
- Excluded subcarriers that are zero valued

This signal is described according to the following IDFT equation:

$$x(i) = \frac{1}{\sqrt{N}} \sum_{k=0}^{N-1} X(k) \exp(j \frac{2\pi i (k - \frac{N}{2})}{N}), \text{ for } i = 0, 1, \dots, (N - 1)$$

The resulting time domain discrete signal,  $x(i)$ , is a baseband complex-valued signal, sampled at 204.8 Msamples per second.

In this definition of the IDFT:

$X(0)$  is the lowest frequency component;

$X(N/2)$  is the DC component or the mean value of the sequence  $x(i)$ ;

$X(N-1)$  is the highest frequency component.

The IDFT is illustrated in Figure 1–6.

---

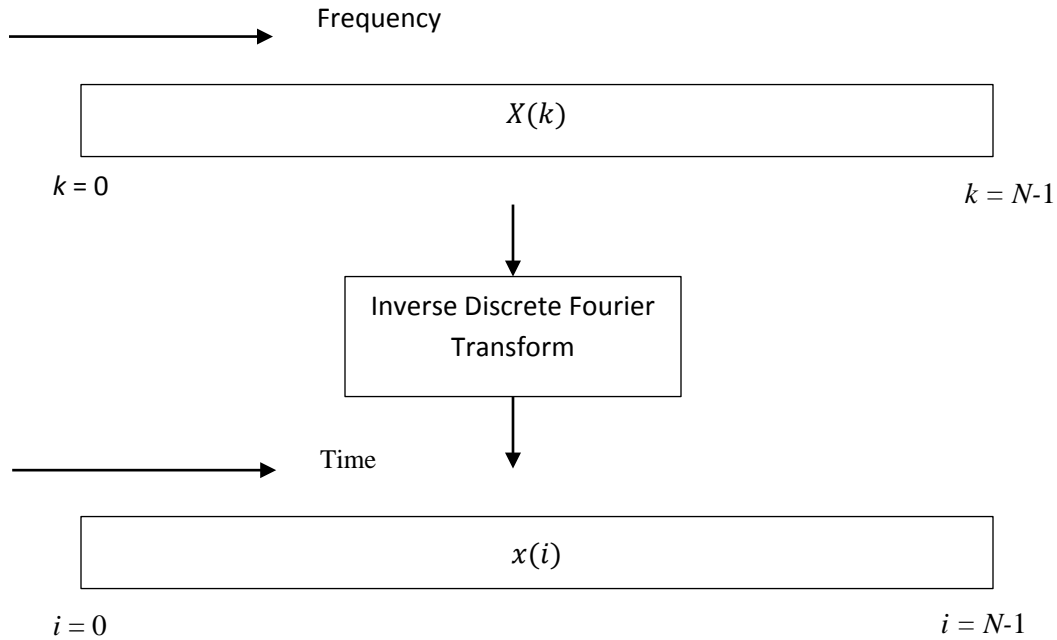

**Figure 1–6 - Inverse Discrete Fourier Transform**

The sample rate in the time domain is 204.8 Msamples/s. Hence, the  $N$  samples of the discrete Fourier transform cover a frequency range of 204.8 MHz. This gives the subcarrier spacing shown in Table 1–2.

**Table 1–2 - Subcarrier Spacing**

IDFT Size $N$	Carrier Spacing
4096	50 kHz
8192	25 kHz

The maximum channel bandwidth is 192 MHz; this corresponds to 3841 subcarriers in 4K mode and 7681 subcarriers in 8K mode. The active bandwidth of the channel is expected to be 190 MHz; this corresponds to 3801 subcarriers in 4K mode and 7601 subcarriers in 8K mode.

Table 1–3 describes what the different values of  $k$  mean for 4K FFTs and 8K FFTs.

---

**Table 1–3 -  $k$  Definitions for 4K and 8K FFT**

Value of $k$		Description
4K FFT	8K FFT	
0	0	Lowest frequency subcarrier of the DFT
128	256	Lower-end subcarrier of the 192 MHz channel
148	296	Lower-end subcarrier of the 190 MHz band
2048	4096	DC component
3948	7896	Upper-end subcarrier of the 190 MHz band
3968	7936	Upper-end subcarrier of the 192 MHz channel
4095	8191	Highest frequency subcarrier of the DFT

The OFDM channel bandwidth can be any value from 24 MHz to 192 MHz; smaller bandwidths than 192 MHz are achieved by nulling subcarriers  $X(k)$  prior to the IDFT. Note that the channel need not be centered at the subcarrier  $k = N/2$ , although this would be the most logical approach when transmitting a channel with bandwidth less than 192 MHz.

For example, consider transmitting an OFDM signal with a subcarrier spacing of 25 kHz over a 24 MHz channel with an active bandwidth of 22 MHz. The channel would have 881 active subcarriers, including all edge subcarriers. The most logical thing to do would be to assign these active subcarriers to:

$$\{X(k), k = 3656, 3657, \dots, 4095, 4096, 4097, \dots, 4535, 4536\}$$

All other subcarriers are nulled for exclusion. This results in a channel that is symmetrically placed around the DC component of the time domain sequence  $\{x(i), i = 0, 1, \dots, 8191\}$ . However, the 881 active subcarriers may occupy any other contiguous region of the frequency domain sequence  $\{x(k), k = 0, 1, \dots, 8191\}$ .

#### **1.2.6.5 Subcarrier Referencing**

It is necessary to refer to specific OFDM subcarriers for several definitions:

- a) Defining continuous pilot locations
  - b) Defining exclusion bands and excluded individual subcarriers
  - c) Defining bit loading profiles
-

Each of these definitions uses the index  $k$  of the equation defined in the preceding section to refer to a specific subcarrier.

The subcarrier index goes from 0 to 4095 for the 4K FFT and from 0 to 8191 for the 8K FFT; each of these definitions is limited to these subcarrier indices.

The PLC is also defined with reference to  $k = 0$ . The OFDM template carried by the PLC defines the subcarrier index of the lowest frequency subcarrier of the PLC. Hence, once the CNU detects the PLC, the CNU knows the location of  $k = 0$ . Since the FFT size is also known, it is possible to precisely compute the FFT of the data channel containing the PLC.

Note that scattered pilot placement is not referenced to  $k = 0$ ; instead, it is referenced directly to the PLC preamble.

### **1.2.7 Cyclic Prefix and Windowing**

This section describes how cyclic prefixes are inserted and how a window is applied to the output of the IDFT at the CLT and how they are handled by the CNU.

The addition of a cyclic prefix enables the receiver to overcome the effects of inter-symbol-interference and inter-carrier-interference caused by micro-reflections in the channel. Windowing maximizes channel capacity by sharpening the edges of the spectrum of the OFDM signal. Spectral edges occur at the two ends of the spectrum of the OFDM symbol, as well as at the ends of internal exclusion bands.

The number of active OFDM subcarriers can be increased by sharpening these spectral edges. However, sharper spectral edges in the frequency domain imply longer tapered regions in the time domain, resulting in increased symbol duration and reduction in throughput. Therefore, there is an optimum amount of tapering that maximizes channel capacity. This optimum is a function of channel bandwidth as well as the number of exclusion bands.

#### **1.2.7.4 Cyclic Prefix Insertion and Windowing**

The CLT MUST follow the procedure described in section 1.1.8.2 for cyclic prefix insertion and windowing, using CLT specific cyclic prefix and roll-off period values.

The CLT MUST support cyclic prefix extension and windowing as described in section 1.1.8.2.

The CLT MUST support the cyclic prefix values defined in Table 1–4 for both 4K and 8K FFTs.

The CNU MUST support the cyclic prefix values listed defined Table 1–4 for both 4K and 8K FFTs.

---



**Table 1–4 - Cyclic Prefix (CP) Values**

Cyclic Prefix ( $\mu\text{s}$ )	Cyclic Prefix Samples ( $N_{cp}$ )
0.9375	192
1.25	256
2.5	512
3.75	768
5.0	1024

The cyclic prefix (in  $\mu\text{s}$ ) are converted into samples using the sample rate of 204.8 Msamples/s and is an integer multiple of:  $1/64 * 20 \mu\text{s}$ .

The CLT MUST support the five parameter values specified for this roll-off listed in Table 1–5.

**Table 1–5 - Roll-Off Prefix (RP) Values**

Roll-Off Period ( $\mu\text{s}$ )	Roll-Off Period Samples ( $N_{rp}$ )
0	0
0.15625	32
0.3125	64
0.625	128
0.9375	192
1.25	256

The CLT MUST NOT allow a configuration in which the RP value is  $\geq$  the CP value.

**[NOTE: the following section is from D3.1 PHY I01 Section 7.4.11.1]**

**1.2.7.5 Cyclic Prefix and Windowing Algorithm**

The algorithm for cyclic prefix extension and windowing is described here with reference to Figure 1-7.

The CNU MUST support cyclic prefix extension and windowing as described in this section.

---

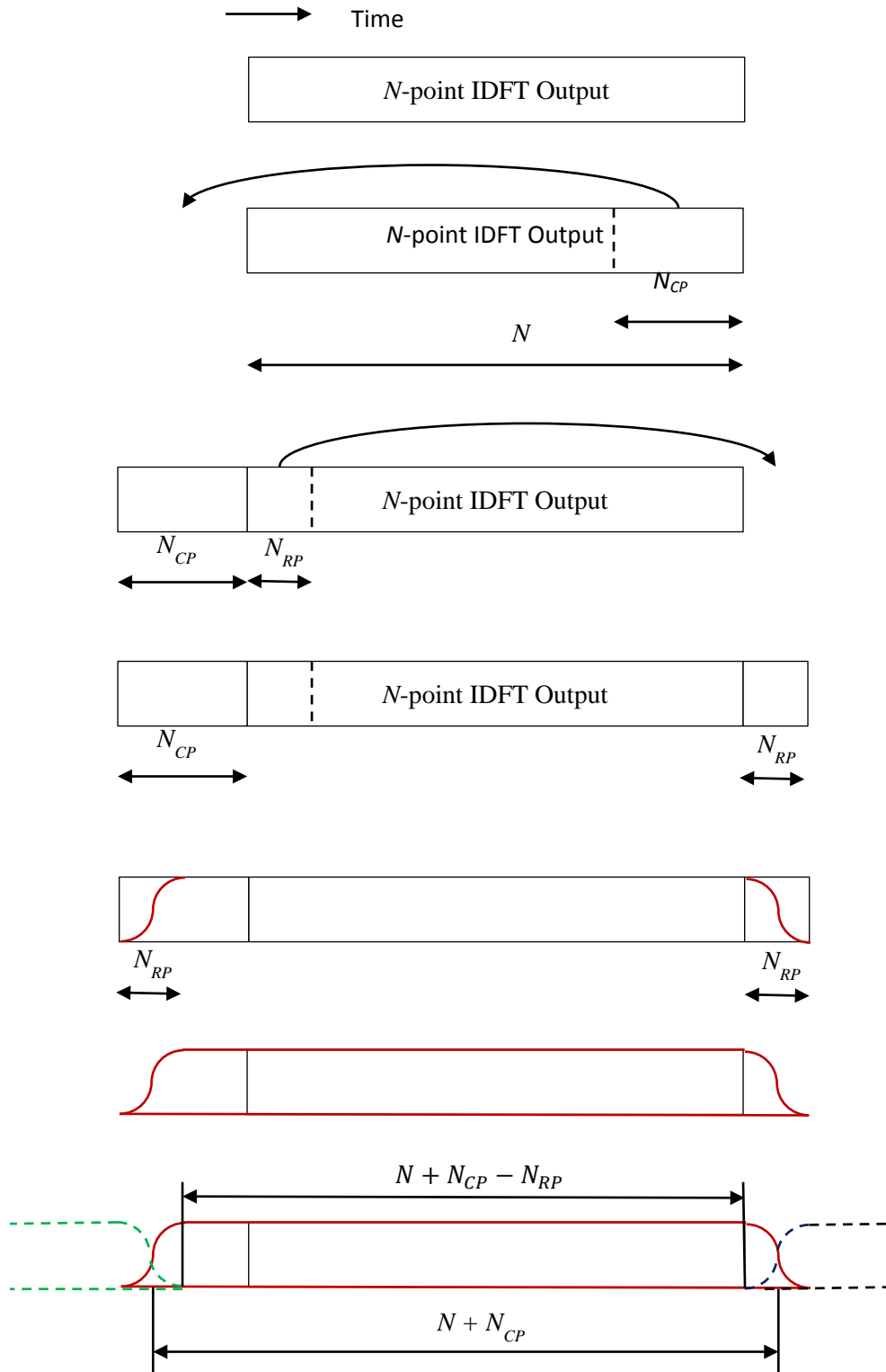

**Figure 1-7 – Cyclic Prefix and Windowing Algorithm**

Processing begins with the  $N$ -point output of the IDFT. Let this be:

$$\{x(0), x(1), \dots, x(N-1)\}$$

The  $N_{CP}$  samples at the end of this  $N$ -point IDFT are copied and prepended to the beginning of the IDFT output to give a sequence of length  $(N+N_{CP})$ :

$$\{x(N-N_{CP}), x(N-N_{CP}+1), \dots, x(N-1), x(0), x(1), \dots, x(N-1)\}$$

The  $N_{RP}$  samples at the start of this  $N$ -point IDFT are copied and appended to the end of the IDFT output to give a sequence of length  $(N+N_{CP}+N_{RP})$ :

$$\{x(N-N_{CP}), x(N-N_{CP}+1), \dots, x(N-1), x(0), x(1), \dots, x(N-1), x(0), x(1), \dots, x(N_{RP}-1)\}$$

Let this extended sequence of length  $(N+N_{CP}+N_{RP})$  be defined as:

$$\{y(i), i = 0, 1, \dots, (N+N_{CP}+N_{RP}-1)\}$$

$N_{RP}$  samples at both ends of this extended sequence are subject to tapering. This tapering is achieved using a raised-cosine window function; a window is defined to be applied to this entire extended sequence. This window has a flat top and raised-cosine tapering at the edges, as shown in Figure Error! No text of specified style in document.-8.

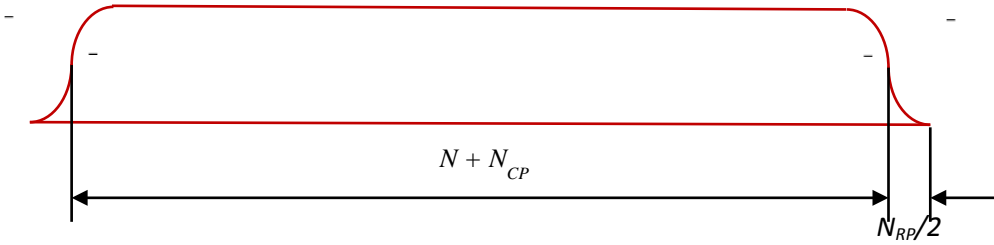

Figure Error! No text of specified style in document.-7 – Tapering Window

The window function  $w(i)$  is symmetric at the center; therefore, only the right half of the window is defined in the following equation:

$$w\left(\frac{N+N_{CP}+N_{RP}}{2}+i\right) = 1.0, \text{ for } i = 0, 1, \dots, \left(\frac{N+N_{CP}-N_{RP}}{2}-1\right)$$

$$w\left(i+\frac{N+N_{CP}+N_{RP}}{2}\right) = \frac{1}{2} \left(1 - \sin\left(\frac{\pi}{\alpha(N+N_{CP})}\left(i-\frac{N+N_{CP}}{2}+1/2\right)\right)\right),$$

$$\text{for } i = \left(\frac{N+N_{CP}-N_{RP}}{2}\right), \dots, \left(\frac{N+N_{CP}+N_{RP}}{2}-1\right)$$

Here,

$$\alpha = \frac{N_{RP}}{N+N_{CP}}$$

defines the window function for  $(N+N_{CP}+N_{RP})/2$  samples. The complete window function of length  $(N+N_{CP}+N_{RP})$  is defined using the symmetry property as:

$$w\left(\frac{N+N_{CP}+N_{RP}}{2}-i-1\right) = w\left(\frac{N+N_{CP}+N_{RP}}{2}+i\right),$$

$$\text{for } i = 0, 1, \dots, \frac{N+N_{CP}+N_{RP}}{2}-1$$

---

This yields a window function (or sequence):  $\{w(i), i = 0, 1, \dots, (N + N_{CP} + N_{RP} - 1)\}$ . The length of this sequence is an even-valued integer.

The above window function is applied to the sequence  $\{y(i)\}$ :

$$z(i) = y(i) w(i), \text{ for } i = 0, 1, \dots, (N + N_{CP} + N_{RP} - 1)$$

Each successive set of  $N$  samples at the output of the IDFT yields a sequence  $z(i)$  of length  $(N + N_{CP} + N_{RP})$ . Each of these sequences is overlapped at each edge by  $N_{RP}$  samples with the preceding and following sequences, as shown in the last stage of Figure Error! **No text of specified style in document.**-7. Overlapping regions are added together.

To define this "overlap and add" function mathematically, consider two successive sequences  $z_1(i)$  and  $z_2(i)$ . The overlap and addition operations of these sequences are defined using the following equation:

$$z_1(N + N_{CP} + i) + z_2(i), \text{ for } i = 0, 1, \dots, N_{RP} - 1$$

That is, the last  $N_{RP}$  samples of sequence  $z_1(i)$  are overlapped and added to the first  $N_{RP}$  samples of sequence  $z_2(i)$ .

### 1.2.8 Fidelity Requirements

**[NOTE: this section is contained in another baseline proposal.]**

### 1.2.9 CLT Transmitter Output Requirements

**[NOTE: this section is contained in another baseline proposal.]**

### 1.2.10 Cable Modem Receiver Input Requirements

**[NOTE: this section is contained in another baseline proposal.]**

### 1.2.11 Cable Modem Receiver Capabilities

**[NOTE: this section is contained in another baseline proposal.]**

### 1.2.12 Physical Layer Link Channel (PLC)

This section contains the description of the Physical layer Link Channel (PLC) that the CLT follows during the construction of the PLC.

The aim of the PLC is for the CLT to convey to the CNU the physical properties of the OFDM channel. In a blind acquisition, that is, in an acquisition without prior knowledge of the physical parameters of the channel, the CNU first acquires the PLC, and from this extracts the parameters needed to acquire the complete OFDM channel.

#### 1.2.12.4 PLC Placement

The CLT MUST transmit a PLC for every downstream OFDM channel.

The CLT MUST place this PLC on a 1 MHz grid, that is, the center frequency of the lowest frequency subcarrier of the PLC has to be an integer number of MHz.

---

**1.2.12.5 PLC Structure**

The CLT MUST place the PLC so that it occupies the same set of contiguous subcarriers in every OFDM symbol.

The CLT MUST place 8 OFDM subcarriers in the PLC of every OFDM symbol when using 4K FFT OFDM (i.e., a subcarrier spacing of 50 kHz).

The CLT MUST place 16 OFDM subcarriers in the PLC of every OFDM symbol when using 8K FFT OFDM (i.e., a subcarrier spacing of 25 kHz).

**Table 1–6 - PLC components**

DFT size	Subcarrier spacing	Number of PLC subcarriers ( $N_p$ )
4096	50 kHz	8
8192	25 kHz	16

The CLT MUST use a 16-QAM constellation for the PLC subcarriers.

The CLT MUST construct the PLC as 8 symbols of preamble followed by 120 symbols of data subcarriers, as shown in Figure 1–9.

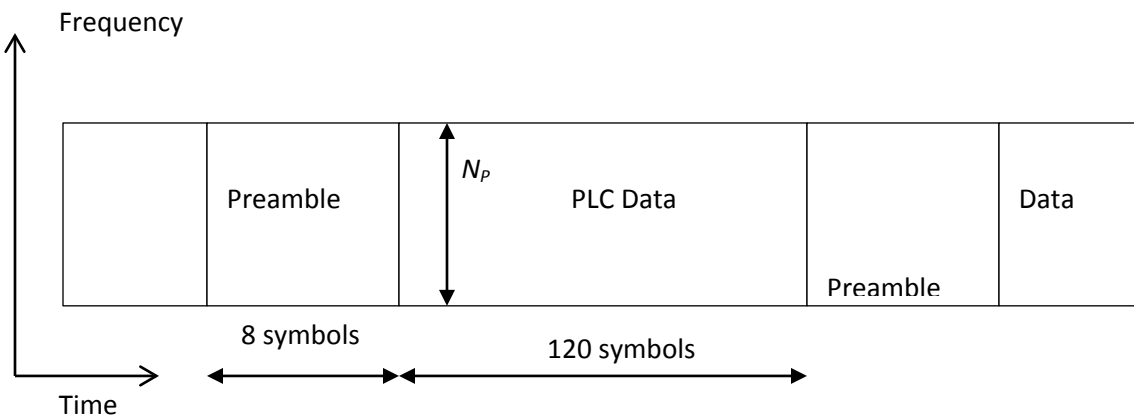

**Figure 1–8 - Structure of the PLC**

---

The CLT MUST place the PLC at the center of a 6 MHz within the active bandwidth of the OFDM channel. For 4K FFT OFDM, this 6 MHz channel, in the increasing order of frequency, will consist of 56 subcarriers followed by the 8 PLC subcarriers followed by another 56 subcarriers. For 8K FFT OFDM, this 6 MHz channel, in the increasing order of frequency, will consist of 112 subcarriers followed by the 16 PLC subcarriers followed by another 112 subcarriers.

The CLT MUST NOT insert any exclusion zones or excluded subcarriers within this 6 MHz band that contains the PLC, including the PLC.

The CLT MUST insert 8 continuous pilots in this 6 MHz bandwidth, 4 on each side of the PLC, as defined in the section on downstream pilots.

The CLT MUST interleave the PLC subcarriers on their own, as described in the section on "PLC Interleaving".

The CLT MUST NOT interleave the PLC preamble.

The CLT MUST synchronize the scattered pilot pattern to the PLC preamble as defined in section 1.1.15 such that in the OFDM symbol that follows the last symbol of the preamble sequence, the subcarrier next to the highest-frequency subcarrier in the PLC is a scattered pilot.

The CLT MUST NOT insert any scattered pilots or continuous pilots within the PLC frequency band.

The CLT MUST synchronize the downstream data randomizer to the PLC preamble as described in the section on "Downstream Data randomization". That is, the CLT must initialize the downstream randomizer just before the lowest frequency data subcarrier of the first OFDM symbol following the preamble.

The CLT MUST synchronize the downstream PLC randomizer to the PLC preamble as described in the section on "Downstream PLC randomization". That is, the CLT MUST initialize the downstream PLC randomizer just before the lowest frequency PLC subcarrier of the first OFDM symbol following the preamble.

Two possible locations for the PLC channel are illustrated in the example of **Figure 1–10**. In this example there are three contiguous OFDM spectral bands in the 192 MHz channel, of width 22, 12 and 5 MHz. There are two exclusion zones between these. The spectrum outside these bands is also excluded.

It is not necessary to place the PLC in the largest contiguous spectral segment of the OFDM channel. The 6 MHz channel containing the PLC at its center may be anywhere provided it contains 6 MHz of spectrum without any excluded subcarriers. In the example given the one possible location for the PLC channel is in the 12 MHz wide segment.

Since the downstream channel will contain a minimum of 22 MHz of contiguous OFDM spectrum, there will always be a spectral band to place the PLC. It may be noted that it not necessary to place the PLC at the center of the 22 MHz bandwidth.

---

The CLT is expected to place the PLC in part of the spectrum that is less susceptible to noise and interference.

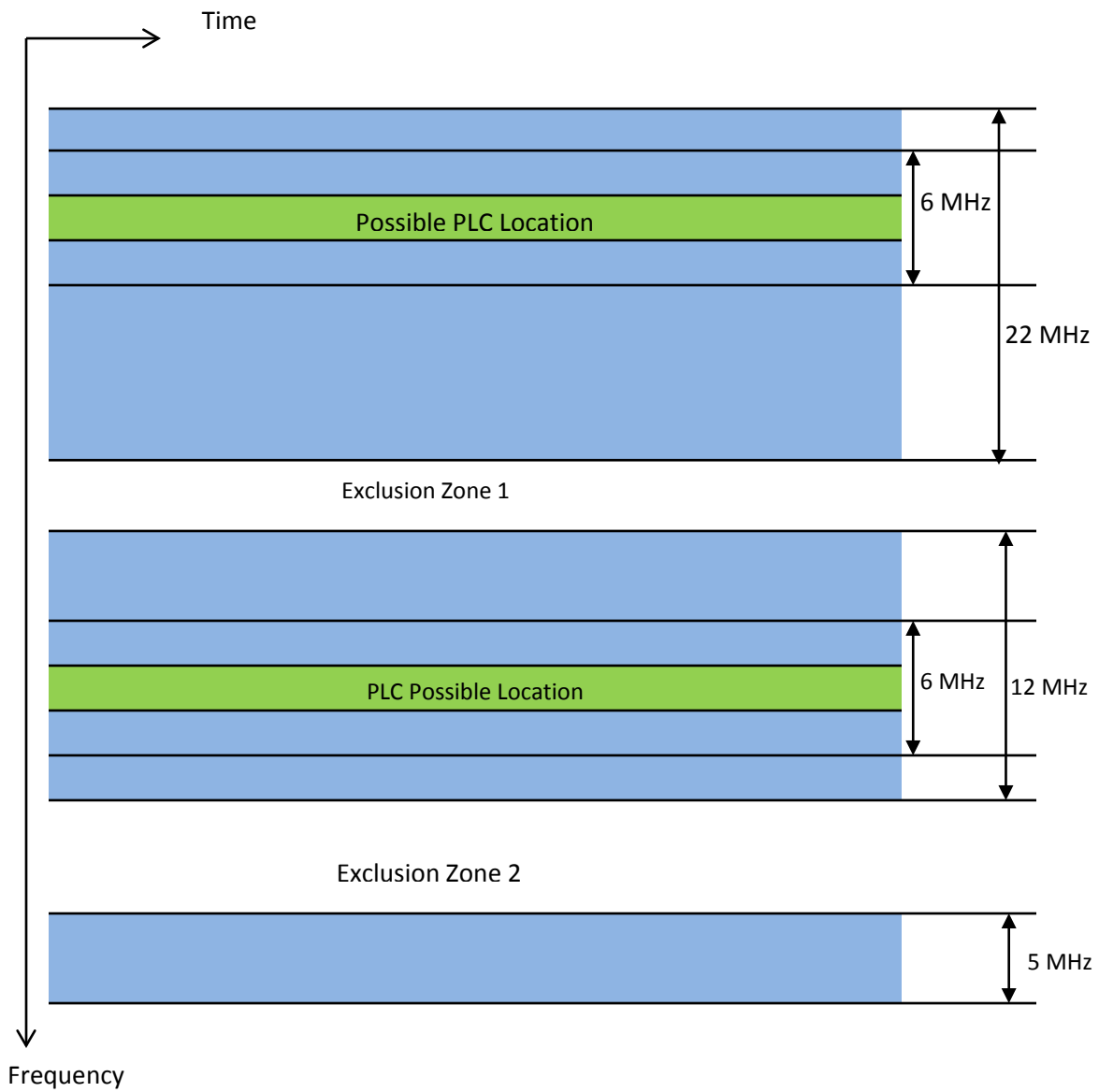

**Figure 1–9 - Examples of PLC placement**

The CLT MUST generate the PLC as shown in **Figure 1–11**:

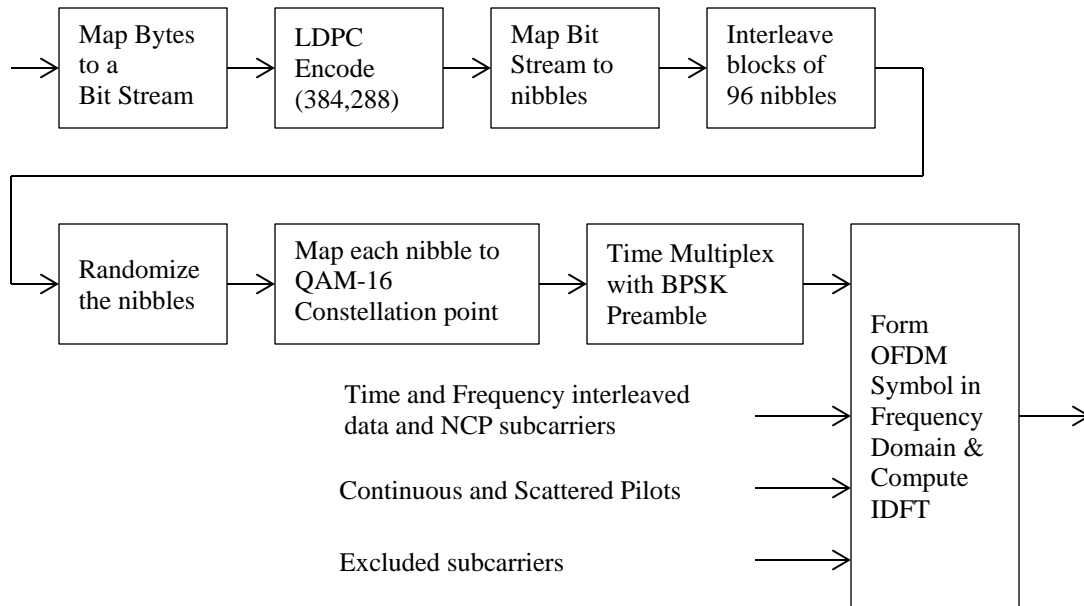

**Figure 1–10 - Physical Layer Operations for Forming the PLC Subcarriers**

**1.2.12.6 PLC Preamble Modulation**

**[NOTE: Verify with montreuil\_3bn\_01\_0713.pdf]**

The CLT PLC transmitted preamble will MUST use BPSK. The Preamble will be cyclically extended in frequency for 16, 32 and 64 subcarriers. The intent of the PLC Preamble is to provide correlation in frequency direction first and then correlation in time direction next (e.g. a moving average filter). At each new symbol, reuse previously calculated frequency direction correlation. No need to recalculate all 56 samples (or 112 samples) 2D correlation every time. The preamble configuration for 4K FFT PLC is in Table 1-x and 1-x, and for 8K FFT PLC in Table 1-x and 1-x.

The CLT MUST map each of the above binary bits to a BPSK constellation point in the complex plane using the following transformation:

$$0 \rightarrow (1 + j0)$$

$$1 \rightarrow (-1 + j0)$$



Table 1-x. 4K FFT PLC Preamble

		<b>2-d TX Preamble Sequence – 4K FFT PLC</b>							
		Symbol 1	Symbol 2	Symbol 3	Symbol 4	Symbol 5	Symbol 6	Symbol 7	Symbol 8
<b>Subcarrier -&gt;</b>	Subcarrier 8	1	0	1	0	0	0	1	1
	Subcarrier 7	1	0	1	0	0	0	1	1
	Subcarrier 6	1	0	1	0	0	0	1	1
	Subcarrier 5	0	0	0	0	1	0	1	1
	Subcarrier 4	1	0	1	0	0	0	1	1
	Subcarrier 3	0	0	0	0	1	0	0	1
	Subcarrier 2	0	0	0	0	1	0	0	1
	Subcarrier 1	1	0	1	0	0	0	1	1
		<b>Symbol →</b>							

Table 1-x. 4K FFT PLC Differential Demodulated Sequence

		<b>Differential Demodulation Sequence – 4K FFT PLC</b>							
		Symbol 1	Symbol 2	Symbol 3	Symbol 4	Symbol 5	Symbol 6	Symbol 7	Symbol 8
<b>Subcarrier -&gt;</b>	Subcarrier 8	X	1	1	1	0	0	1	0
	Subcarrier 7	X	1	1	1	0	0	1	0
	Subcarrier 6	X	1	1	1	0	0	1	0
	Subcarrier 5	X	0	0	0	1	1	0	1
	Subcarrier 4	X	1	1	1	0	0	1	0
	Subcarrier 3	X	0	0	0	1	1	0	1
	Subcarrier 2	X	0	0	0	1	1	0	1
	Subcarrier 1	X	1	1	1	0	0	1	0
		<b>Symbol →</b>							

Table 1-x. 8K FFT PLC Preamble

		<b>2-d TX Preamble Sequence – 8K FFC</b>							
		Symbol 1	Symbol 2	Symbol 3	Symbol 4	Symbol 5	Symbol 6	Symbol 7	Symbol 8
<b>Subcarrier -&gt;</b>	Subcarrier 16	1	0	1	0	0	0	1	1
	Subcarrier 15	1	0	1	0	0	0	1	1
	Subcarrier 14	1	0	1	0	0	0	1	1
	Subcarrier 13	1	0	1	0	0	0	1	1
	Subcarrier 12	0	0	0	0	1	0	0	1
	Subcarrier 11	1	0	1	0	0	0	1	1
	Subcarrier 10	0	0	0	0	0	1	0	1
	Subcarrier 9	1	0	1	0	0	0	1	1
	Subcarrier 8	1	0	1	0	0	0	1	1
	Subcarrier 7	0	0	0	0	1	0	0	1
	Subcarrier 6	0	0	0	0	1	0	0	1
	Subcarrier 5	1	0	1	0	0	0	1	1
	Subcarrier 4	0	0	0	0	1	0	0	1
	Subcarrier 3	0	0	0	0	1	0	0	1
	Subcarrier 2	0	0	0	0	1	0	0	1
	Subcarrier 1	1	0	1	0	0	0	1	1
		<b>Symbol →</b>							

Table 1-x. 8K FFC PLC Demodulated Sequence

		<b>Differential Demodulation Sequence – 8K FFT PLC</b>							
		Symbol 1	Symbol 2	Symbol 3	Symbol 4	Symbol 5	Symbol 6	Symbol 7	Symbol 8
<b>Subcarrier ^</b>	Subcarrier 16	X	1	1	1	0	0	1	0
	Subcarrier 15	X	1	1	1	0	0	1	0
	Subcarrier 14	X	1	1	1	0	0	1	0
	Subcarrier 13	X	1	1	1	0	0	1	0
	Subcarrier 12	X	0	0	0	1	1	0	1
	Subcarrier 11	X	1	1	1	0	0	1	0
	Subcarrier 10	X	0	0	0	1	1	0	1
	Subcarrier 9	X	1	1	1	0	0	1	0
	Subcarrier 8	X	1	1	1	0	0	1	0
	Subcarrier 7	X	0	0	0	1	1	0	1
	Subcarrier 6	X	0	0	0	1	1	0	1
	Subcarrier 5	X	1	1	1	0	0	1	0
	Subcarrier 4	X	0	0	0	1	1	0	1
	Subcarrier 3	X	0	0	0	1	1	0	1
	Subcarrier 2	X	0	0	0	1	1	0	1
	Subcarrier 1	X	1	1	1	0	0	1	0
		<b>Symbol →</b>							

**1.2.12.7 PHY Parameters Carried by the PLC**

The PLC conveys OFDM channel description information from the CLT to each CNU. This section contains only a brief description of the physical layer parameters carried by the PLC.

The inverse discrete Fourier transform that defines the OFDM signal at the CLT is given by the following equation:

$$x(i) = \frac{1}{\sqrt{N}} \sum_{k=0}^{N-1} X(k) \exp\left(\frac{j2\pi i(k-\frac{N}{2})}{N}\right); \text{ for } i = 0, 1, \dots, N - 1 \tag{1}$$

The sampling rate in the previous equation is 204.8 Msamples/s and the value of N is either 4096 or 8192. The CLT MUST specify this value of N via the PLC.

The CLT MUST define, via the PLC, the frequency of the subcarrier X(0) in equation (1) as a 32-bit positive integer in units of Hz.

The PLC subcarriers constitute a set of contiguous subcarriers given by:

$$\{X(k), k = L, L + 1, \dots, L + N_p - 1\} \tag{2}$$

The CLT MUST define the value of L to define the location of the PLC within an OFDM channel.

The CLT MUST define the locations of the continuous pilots, excluding the eight predefined ones, via the PLC.

The CLT MUST define the locations of excluded subcarriers via the PLC.

The CLT MUST define the bit loading profile for all 4096 or 8192 subcarriers of equation (1), excluding continuous pilots and excluded subcarriers, via the PLC.

The CLT MUST use the indices  $k$  of equation (1) to specify the locations of subcarriers in all of the above definitions.

In addition to above, the CLT MUST define the following physical parameters of the OFDM channel:

- Cyclic prefix length (five possible settings)
- Roll-off postfix (RP) (six possible settings)
- Time interleaver depth (any integer from 0 to 32).
- Modulation of the NCP (QPSK, QAM-16 or QAM-64)

**1.2.12.8 Mapping of Bytes to a Bit Stream**

The CLT MUST convert the stream of bytes received by the PLC into a stream of bits, MSB first, as illustrated in Figure Error! No text of specified style in document.–12.

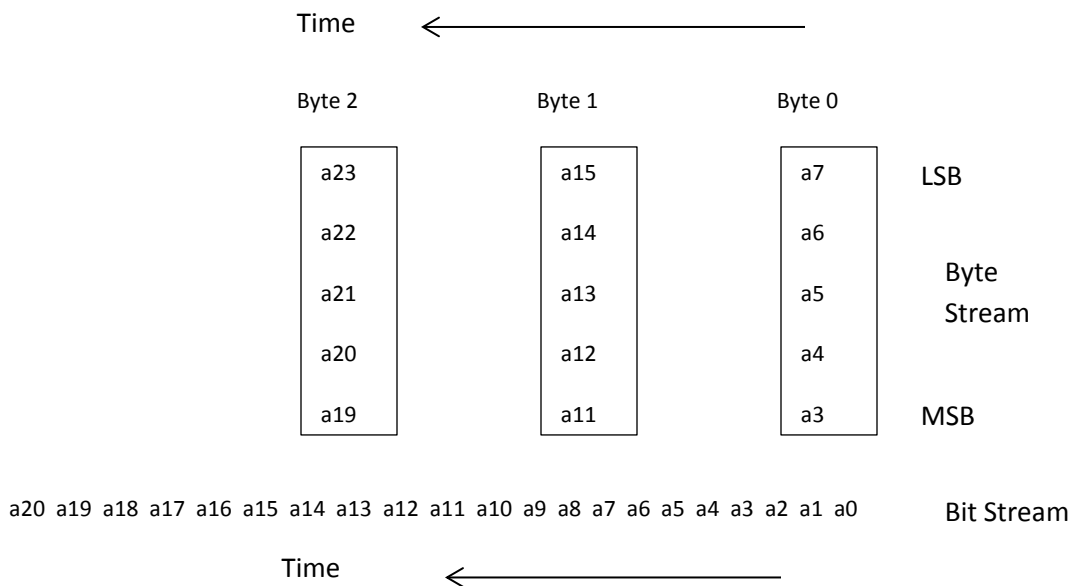

**Figure Error! No text of specified style in document.–11 - Mapping Bytes into a Bit Stream for FEC Encoding**

**1.2.12.9 Forward Error Correction code for the PLC**

The CLT MUST encode the PLC data using (384,288) puncturing LDPC encoder, see Section Error! Reference source not found. for the definition of puncturing encoder.

---

The puncturing encoder uses the same mother encoder for fine ranging FEC (Section 1.1.13.7), that is the rate 3/5 (480,288) LDPC encoder listed in Table 7-14.

**Table 7-7 - Cyclic Prefix and Roll-Off samples for initial ranging**

Cyclic Prefix Samples ( $N_{cp}$ )	Roll-Off Samples ( $N_{rp}$ )
96	96
128	128
160	160
192	192
224	224
256	224
288	224
320	224
384	224
512	224
640	224

**[NOTE: Table 7-14 above is copied by from D3.1 PHY I01 Section 7.4.15.1]**

Denote the information bits sent to the mother code encoder by  $(a_0, \dots, a_{287})$  and let the encoder output being  $(a_0, \dots, a_{287}, b_{288}, \dots, b_{479})$ , where  $b_{288}, \dots, b_{479}$  are parity-check bits. The coordinates to be deleted by the puncturing step are:

Period 1: 48 consecutive coordinates  $a_{48}, \dots, a_{95}$

Period 2: 48 consecutive coordinates  $b_{384}, \dots, b_{431}$

<gork>

Note: Also see Figure 1-28.

The puncturing is described in Figure 1-13.

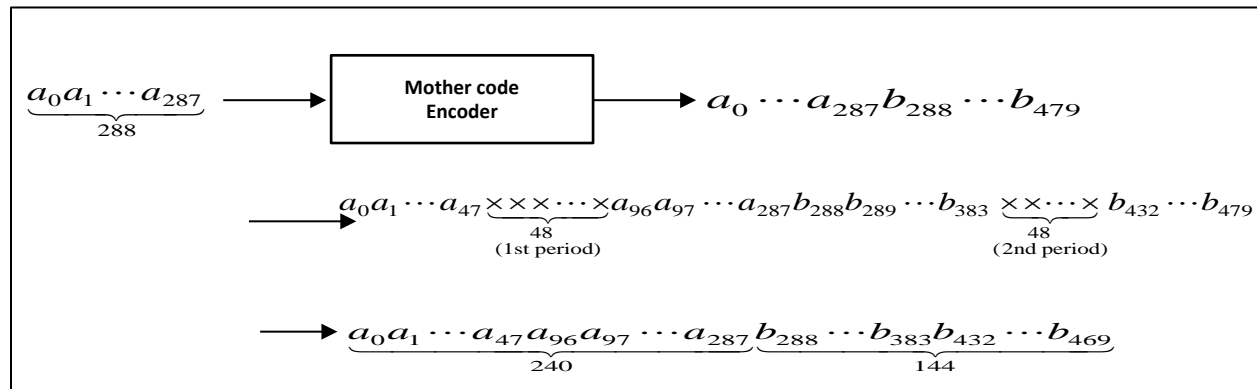

**Figure 1-12 - Puncturing Encoder for the PLC FEC**

**[NOTE: The following subsection is from D3.1 PHY I01 Section 7.4.15.2.3 and is copied here for reference. The PLC FEC shares the same mother code as the Fine Ranging FEC.]**

**1.2.12.10 Fine Ranging FEC (Also PLC FEC)**

The CLT MUST encode the 34 bytes of fine ranging information data using (362,272) shortening and puncturing LDPC encoder.

Shortening and puncturing encoder consists of three steps. In this step, the shortening step, one or more information bits are filled with 0 and the rest are filled with input bits. Then all information bits are encoded using the mother code matrix. After mother code encoding, the zero filled bits are deleted. The puncturing step is as described in Section 7.4.x.x.

The mother code is a rate 3/5 (480,288) binary LDPC code. A parity check matrix of the mother code is represented by Table 7-15, where sub-matrix size (lifting factor) L = 48, see Section 7.5.4.1 for the compact definition of parity check matrix.

**Table 7-158 - (480, 288) LDPC Code Parity Check Matrix**

16	1	28	9	40	38	16	-	-	-
28	42	36	11	39	9	8	38	-	-
5	2	18	16	25	47	-	2	19	-
18	18	40	18	0	34	-	-	7	32

Denote the information bits sent to the mother code encoder by  $(a_0, \dots, a_{271})$  and let the encoder output being  $(a_0, \dots, a_{271}, b_{288}, \dots, b_{479})$ , where  $b_{288}, \dots, b_{479}$  are parity-check bits. Then the shortening and puncturing steps can be described as follows:

The shortening step fills 0 to 16 consecutive bits starting at position 272, i.e., let  $a_{272} = a_{273} = \dots = a_{287} = 0$ . The rest 272 bits i.e.,  $a_0, \dots, a_{271}$ , are fine ranging information data.

The bits to be deleted by the puncturing step are:

- Period 1: 54 consecutive bits  $a_0, a_1, \dots, a_{53}$
- Period 2: 48 consecutive bits  $b_{432}, b_{433}, \dots, b_{479}$

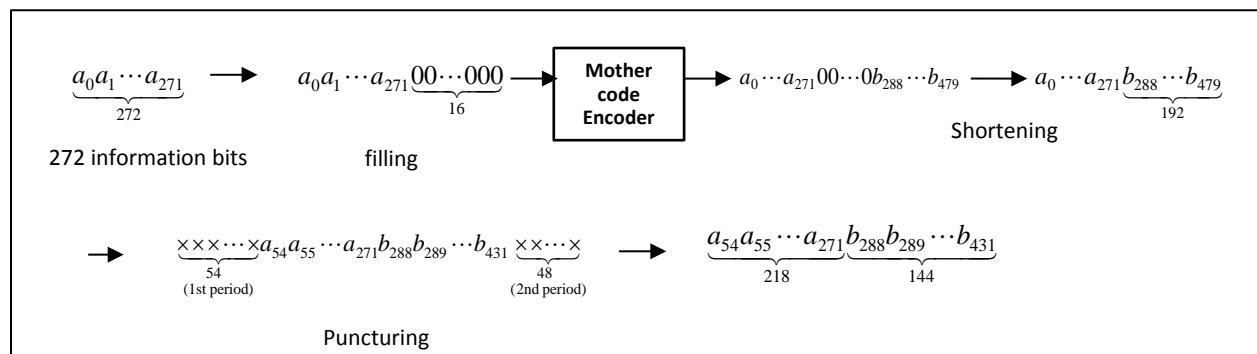
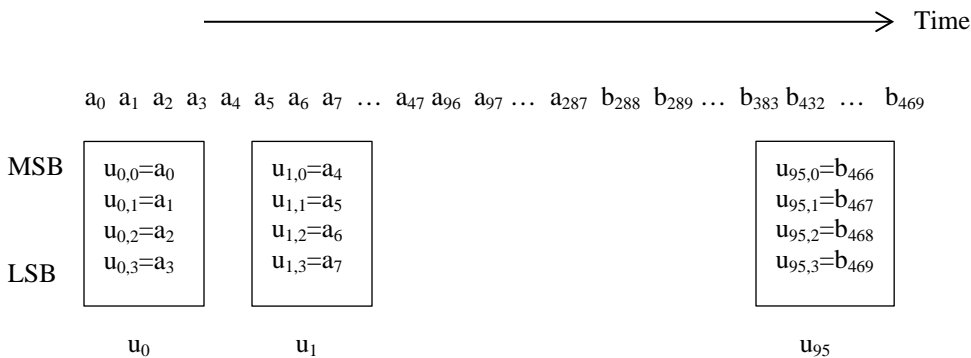

**Figure .1-13 - Shortening and Puncturing Encoder for The Fine Ranging FEC**

**1.2.12.11 Block Interleaving of the PLC Subcarriers**

The preceding section shows 240 data bits entering the LDPC encoder and 384 encoded bits exiting the LDPC encoder. This sequence is in effect is time-reversed order. The time-ordered sequence takes the form shown in the figure below.

The CLT MUST map these 384 data bits into 96 4-bit nibbles  $\{u_i, i = 0, 1, \dots, 95\}$  as described below using Figure 1–15 before interleaving.



**Figure 1–14 - Mapping Encoded Bit Stream into a Stream of Nibbles**

The CLT MUST interleave this 96-nibble sequence  $\{u_0 u_1 u_2 \dots u_{95}\}$  as described below.

For 4K FFT, the CLT MUST use an (8x12) array. The CLT MUST write the values  $u_i$  along the rows of this two-dimensional array, as shown in **Figure 1–16**.

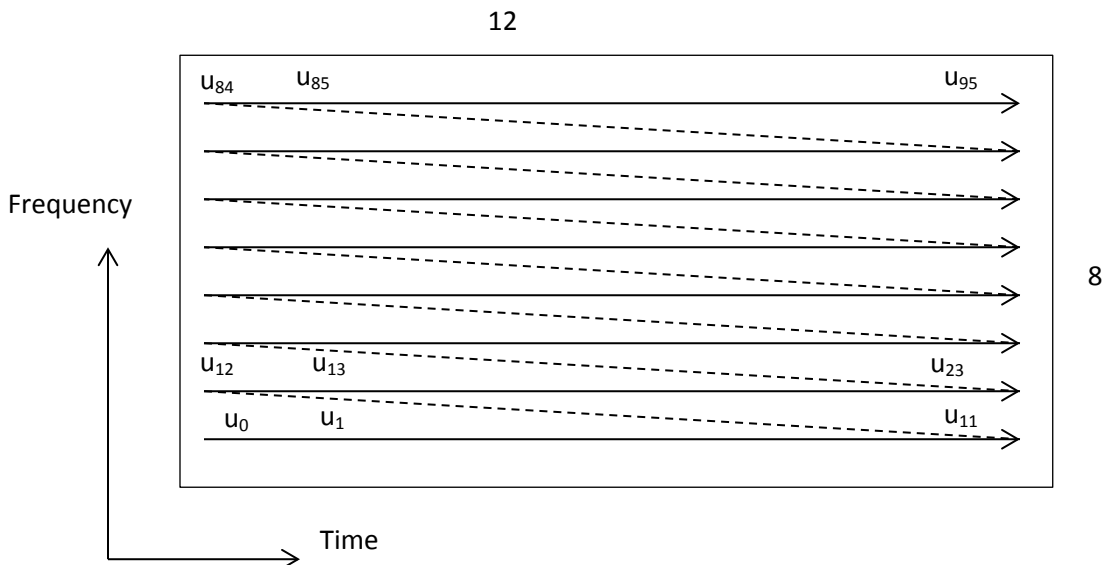

**Figure 1–15 - Block Interleaving of PLC Subcarriers for 4K FFT**

The CLT MUST then read this two-dimensional array along vertical columns to form the two-dimensional sequence  $\{v_{t,f}, t = 0, 1, \dots, 11 \text{ and } f = 0, 1, \dots, 7\}$ . This operation is mathematically represented as:

$$v_{t,f} = u_{t+12f}$$

The CLT MUST map each of the 8-point sequence given below to the 8 successive PLC subcarriers of an OFDM symbol after randomization described in the next section.

$$V_t = \{v_{t,f}, f = 0, 1, \dots, 7\} \quad \text{for 12 successive OFDM symbols } t = 0, 1, \dots, 11$$

Therefore each FEC codeword will occupy the PLC segment of twelve successive 4K FFT OFDM symbols. There will be ten such codewords in an 128-symbol PLC frame, including the 8-symbol preamble.

The CLT MUST map ten complete FEC codewords into one 4K FFT OFDM frame.

For 8K FFT, the CLT MUST use a (16 x 6) array. The CLT MUST write the values  $u_i$  along the rows of this two-dimensional array, as shown Figure 1–17.

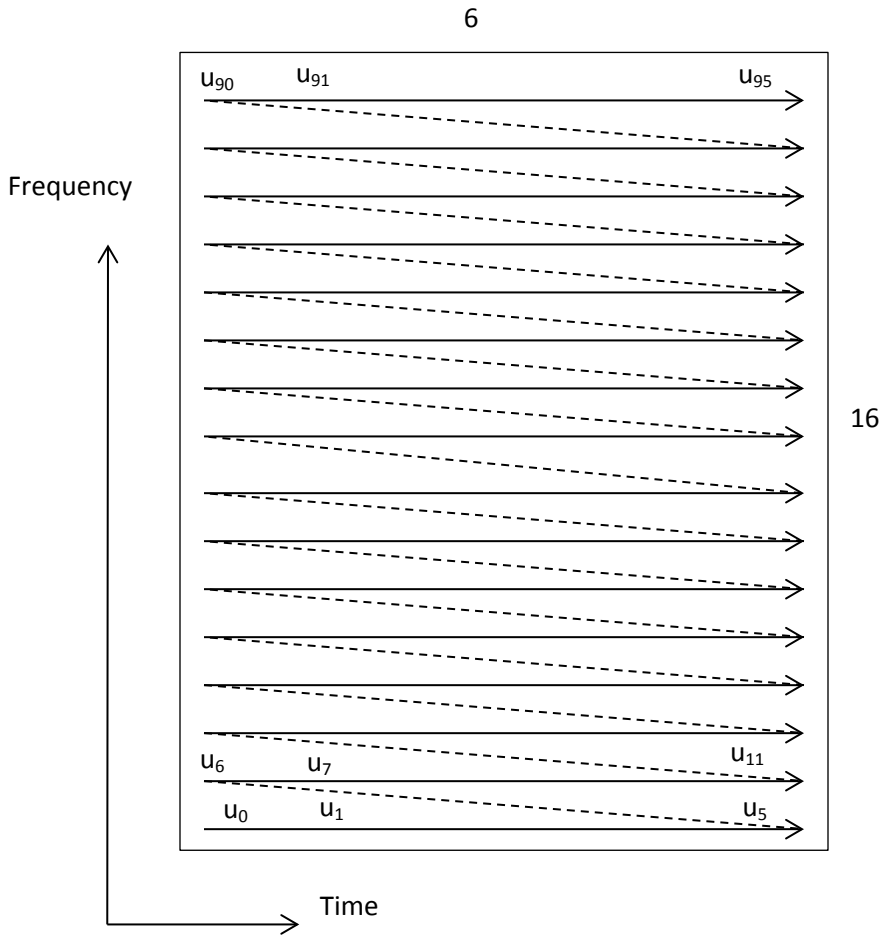

**Figure 1–16 - Block Interleaving of PLC Subcarriers for 8K FFT**

The CLT MUST then read this two-dimensional array along vertical columns to form the two-dimensional sequence  $\{v_{t,f}, t = 0, 1, \dots, 5 \text{ and } f = 0, 1, \dots, 15\}$ . This operation is mathematically represented as:

$$v_{t,f} = u_{t+6f}$$

The CLT MUST map each of the 16-point sequence given below to the 16 successive PLC subcarriers of an OFDM symbol after randomization described in the next section.

$$V_t = \{v_{t,f}, f = 0, 1, \dots, 15\} \quad \text{for 6 successive OFDM symbols } t = 0, 1, \dots, 5$$

Therefore, each FEC codeword will occupy the PLC segment of six successive 8K FFT OFDM symbols. There will be twenty such codewords in an 128-symbol PLC frame, including the 8-symbol preamble.

The CLT MUST map twenty complete FEC codewords into one 8K FFT OFDM frame.

**1.2.12.12 Randomizing the PLC Subcarriers**

The CLT MUST randomize the sequence  $\{v_{t,f}, t = 0, 1, \dots, 5 \text{ and } f = 0, 1, \dots, 15\}$  using a copy of the linear feedback shift register in  $GF[2^{12}]$  used for randomizing the data subcarriers. This is shown in Figure 1–18.

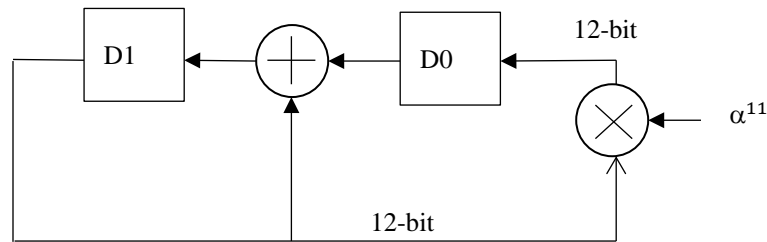

**Figure 1–17 - Linear Feedback Shift Register for PLC Randomization**

The LFSR is defined by the following polynomial in  $GF[2^{12}]$ .

$$x^2 + x + \alpha^{11}$$

The  $GF[2^{12}]$  is defined through polynomial algebra modulo the polynomial:

$$\alpha^{12} + \alpha^6 + \alpha^4 + \alpha + 1$$

This LFSR is initialized to the hexadecimal numbers given below:

---



D0 = "4A7"

D1 = "B4C"

The CLT MUST initialize the LFSR with the above two 12-bit numbers at the beginning of the first OFDM symbol following the PLC preamble. The CLT MUST clock the LFSR once after randomizing one PLC subcarrier. The CLT MUST randomize each subcarrier through an exclusive-OR operation of the 4 bits representing the subcarrier ( $v_{t,f}$ ) with the four LSBs of register D0.

The first subcarrier to be randomized is the lowest frequency subcarrier of the PLC in the OFDM symbol immediately after the preamble. This will be randomized using the four LSBs of the initialized D0, namely 0x7. The LFSR will be clocked once after randomizing each PLC subcarrier of the OFDM symbol. After randomizing the highest frequency PLC subcarrier of an OFDM symbol the CLT MUST clock the LFSR before randomizing the lowest frequency PLC subcarrier in the next OFDM symbol.

The CLT MUST use the bit ordering given below to perform randomization. The four LSBs of D0 are defined as the coefficients of  $\{\alpha^3\alpha^2\alpha^1\alpha^0\}$  of the Galois field polynomial representing D0. The LSB is defined as the coefficient of  $\alpha^0$  of the polynomial representing D0. The ordering of the four bits representing the subcarrier is defined with reference to **Figure 1–15**. Assume that the FEC block shown in **Figure 1–15** is the first FEC block in the PLC frame. Then, since the location of the first nibble does not change as a result of interleaving:

$$v_{0,0} = \{a_0 a_1 a_2 a_3\}$$

Then the randomization operation (i.e., exclusive-OR with 0x7) is given by:

$$\{y_0, y_1, y_2, y_3\} = \{a_0 + 0, a_1 + 1, a_2 + 1, a_3 + 1\}$$

The addition operations in the above equation are defined in GF[2], that is, these are bit-wise exclusive-OR operations. The LFSR is clocked once before randomizing the next nibble  $v_{0,1}$ .

The CLT MUST NOT randomize the PLC preamble.

#### **1.2.12.13 Mapping to 16-QAM Subcarriers**

The CLT MUST map each randomized nibble  $\{y_0y_1y_2y_3\}$  into a complex number using the 16-QAM constellation mapping shown in **Error! Reference source not found.**

The CLT MUST multiply the real and imaginary parts by  $1/\sqrt{10}$  to ensure that mean-square value of the QAM constellation is unity.

#### **1.2.12.14 PLC Timestamp Reference Point**

The PLC subcarriers following the preamble may contain a timestamp.

---

The CLT MUST define this timestamp with reference to the first OFDM symbol following the preamble if such a timestamp exists. This OFDM symbol is indicated by an arrow in Figure 1–19.

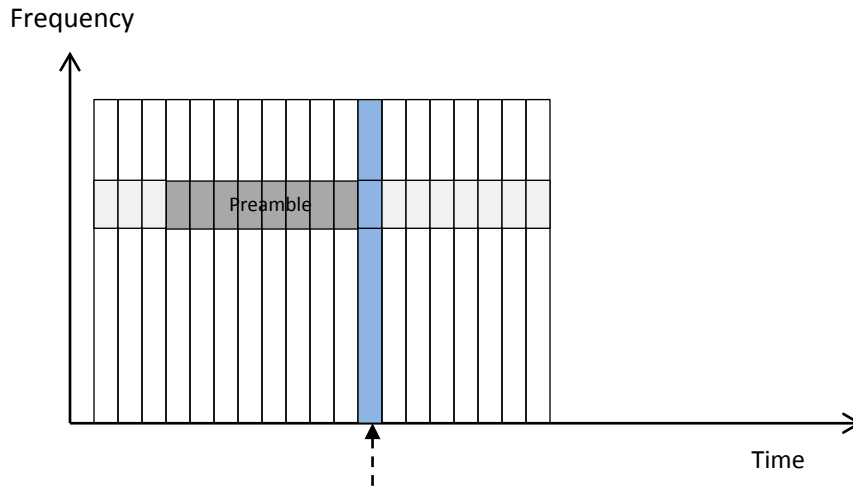
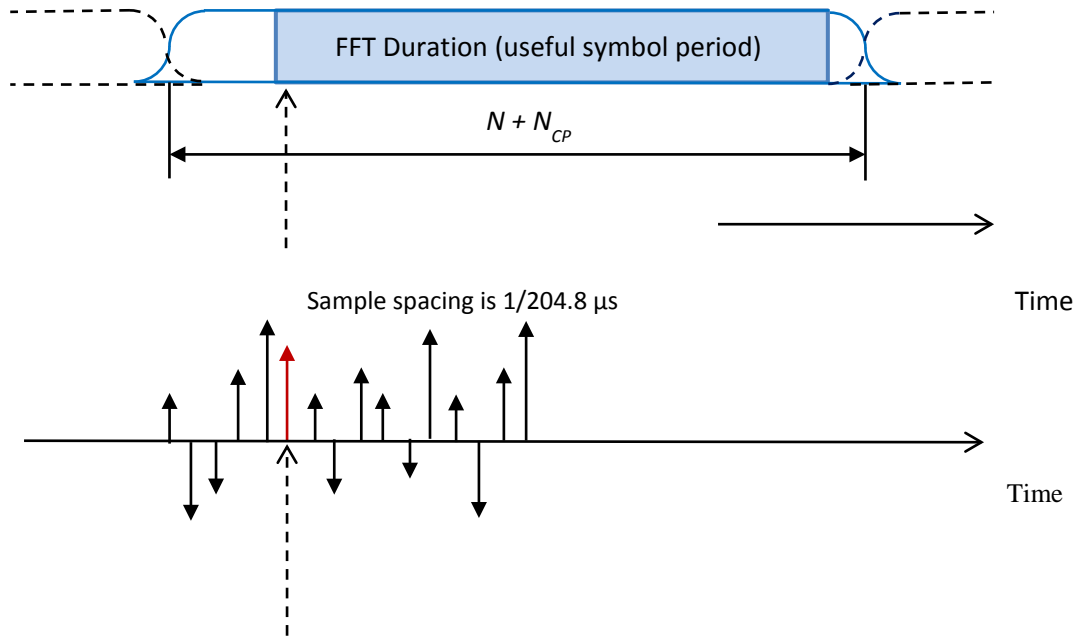

**Figure 1–18 - Time - Frequency Plane Representation of PLC Timestamp Synchronization**

Time domain version of the OFDM symbol is shown in Figure 1–20. The inverse discrete Fourier transform of the symbol of Figure 1–19 results in the set of 4096 or 8192 samples occupying the FFT duration shown. After this the CLT will introduce a configurable cyclic prefix (CP), window the symbol and overlap successive symbols in the time domain.

The CLT MUST use the time of the first sample of the FFT duration as the timestamp.

To clarify this further, individual time domain samples are also shown in Figure 1–20. (This is for illustration only; actual samples are complex-valued.) The sample rate is 204.8 Msamples/s. The dotted arrow points to the first sample of the FFT symbol duration.



**Figure 1–19 - Time Domain Representation of PLC Timestamp Synchronization**

### 1.2.13 Next Codeword Pointer

#### 1.2.13.4 Mapping of Bytes to Bits

Each NCP consists of three bytes as defined in Section 2.1.4. The first byte (Byte 0) contains the profile identifier as the four MSBs and four control bits as the four LSBs. The other two bytes (Byte 1 and Byte 2) contain the start pointer.

The CLT MUST map the three NCP bytes into 24-bit serial bit stream  $\{a_{23} a_{22} \dots a_0\}$  for the purpose of LDPC encoding, as shown in Figure 1–21. Note that the LDPC encoder is also defined using the same bit pattern  $\{a_{23} a_{22} \dots a_0\}$ .

---

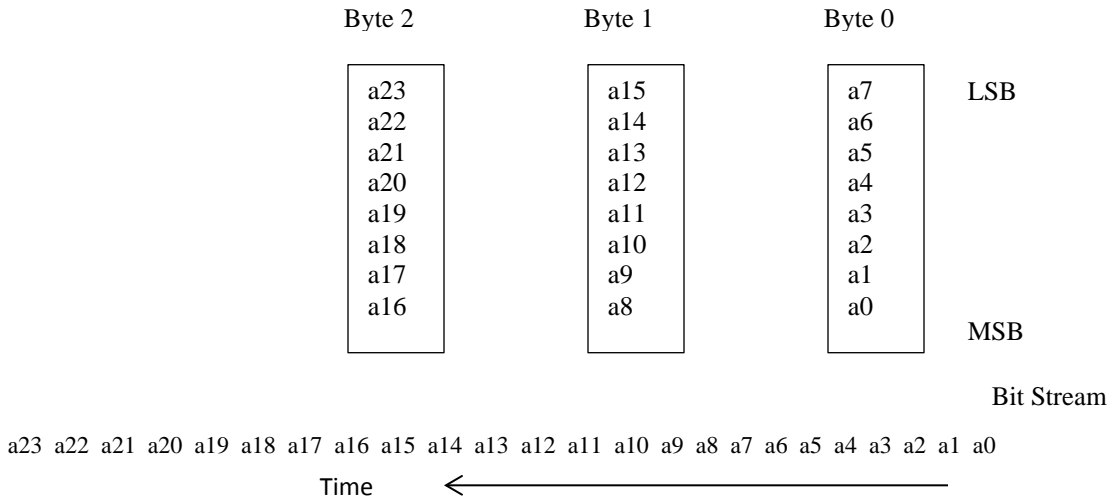

**Figure 1–20 - Mapping NCP Bytes into a Bit Stream for FEC Encoding**

**1.2.13.5 Forward Error Correction code for the NCP**

The CLT MUST encode the 24 information bits of a Next Codeword Pointer using (48, 24) shortening and puncturing LDPC encoder, see Section 1.1.14.2.1 for the definition of shortening and puncturing encoder.

The shortening puncturing encoder uses the same mother encoder for initial ranging FEC (Section **Error! Reference source not found.**), that is the rate 1/2 (160, 80) LDPC encoder listed by Table **Error! No text of specified style in document.**–8.

Denote the information bits sent to the mother code encoder by  $(a_0, \dots, a_{79})$  and let the encoder output being  $(a_0, \dots, a_{79}, b_{80}, \dots, b_{159})$ , where  $b_{80}, \dots, b_{159}$  are parity-check bits. Then the shortening and puncturing steps can be described as follows, also see Figure 1-79:

The shortening step fills 0 to 56 consecutive coordinate starting at position 24, i.e., let  $a_{24} = a_{25} = \dots = a_{79} = 0$ . The rest 24 bits i.e.  $a_0, \dots, a_{23}$ , are NCP information data.

The coordinates to be deleted by the puncturing step are:

- Period 1: 24 consecutive coordinates  $b_{80}, \dots, b_{103}$
- Period 2: 16 consecutive coordinates  $b_{112}, \dots, b_{127}$

- Period 3: 16 consecutive coordinates  $b_{144}, \dots, b_{159}$

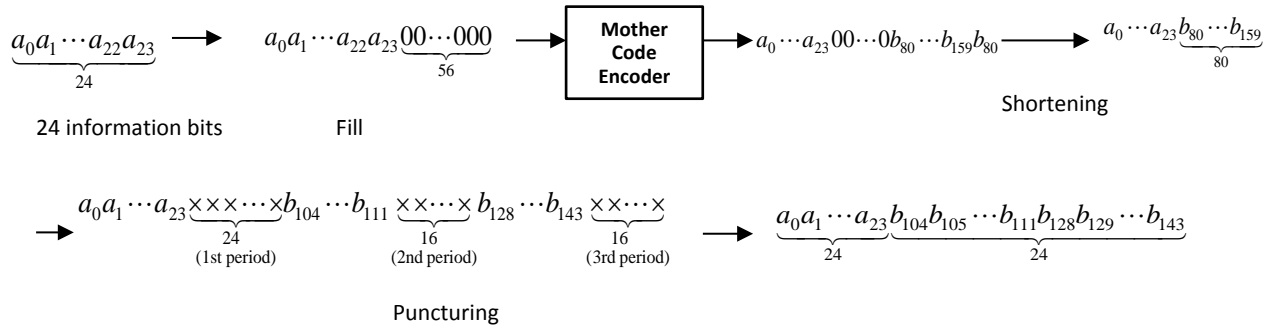

**Figure 1–21 - Shortening and Puncturing Encoder for the NCP FEC**

**[NOTE: this following section is from D3.1 PHY I01 Section 7.4.15.4.]**

1.2.13.5.1 FEC for the NCP (copy of FEC for the Initial Ranging Data from upstream section)

The CLT MUST encode the initial ranging message using the LDPC (128,80) encoder as described below.

A puncturing encoder consists of two steps. The first step encodes the input bit sequence with an encoder of the mother code. The second step, called puncturing step, deletes one or more bits from the encoded codeword.

The mother code is a rate  $\frac{1}{2}$  (160, 80) binary LDPC code. A parity check matrix of the mother code is represented by Table Error! No text of specified style in document.–8, where sub-matrix size (lifting factor)  $L = 16$ , see Section Error! Reference source not found. for the compact definition of parity check matrix.

**Table Error! No text of specified style in document.–9 - (160,80) LDPC code Parity Check Matrix**

1	11	10	12	7	9	-	-	-	-
2	1	14	15	14	14	12	-	-	-
0	9	3	2	-	-	11	7	-	-
6	8	-	10	3	-	-	10	4	-
12	13	11	-	0	-	-	-	5	2

Let the information bits sent to the mother code encoder be denoted by  $(a_0, \dots, a_{79})$  and let the encoder output be denoted by  $(a_0, \dots, a_{79}, b_{80}, \dots, b_{159})$ , where  $b_{80}, \dots, b_{159}$  are parity-check bits. The bits to be deleted by the puncturing step are (also see Figure Error! No text of specified style in document.–23)

- Period 1: 16 consecutive bits  $a_0, \dots, a_{15}$
- Period 2: 16 consecutive bits  $b_{144}, \dots, b_{159}$

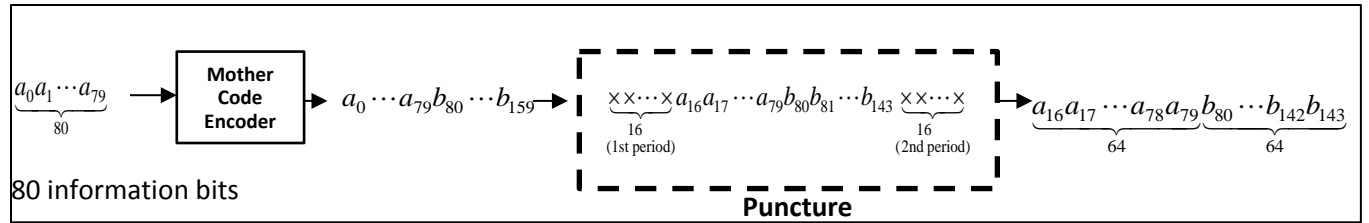

**Figure Error! No text of specified style in document. -22 - LDPC Two-Period Puncturing Encoder for Initial Ranging FEC**

### 1.2.13.6 Mapping LDPC Encoded Bits into to OFDM Subcarriers

The LDPC encoder outputs a stream of 48 bits:

$$\{b_{143} b_{142} \dots b_{128} b_{111} b_{110} \dots b_{104} a_{23} a_{22} \dots a_0\}$$

The NCP QAM constellation can be a member of the set {QPSK, QAM-16, QAM-64}.

For QAM-64 the CLT MUST map the LDPC encoded bits into eight 6-bit QAM constellation points as defined below:

$$\{y_{0,0} y_{0,1} y_{0,2} y_{0,3} y_{0,4} y_{0,5}\} = \{a_5 a_4 a_3 a_2 a_1 a_0\}$$

$$\{y_{1,0} y_{1,1} y_{1,2} y_{1,3} y_{1,4} y_{1,5}\} = \{a_{11} a_{10} a_9 a_8 a_7 a_6\}$$

...

$$\{y_{7,0} y_{7,1} y_{7,2} y_{7,3} y_{7,4} y_{7,5}\} = \{b_{143} b_{142} b_{141} b_{140} b_{139} b_{138}\}$$

The mapping of these 6-bit integers to points in the complex plane is given by the figure below.

Hexadecimal notation has been used to represent the 6-bit numbers  $\{y_{i,0} y_{i,1} y_{i,2} y_{i,3} y_{i,4} y_{i,5}\}$ .

The CLT MUST multiply the real and imaginary parts by  $1/\sqrt{42}$  to ensure that mean-square value of the QAM constellation is unity.



**Figure 1–23 - 64-QAM Constellation Mapping of  $\{y_{i,0}y_{i,1}y_{i,2}y_{i,3}y_{i,4}y_{i,5}\}$**

For QAM-16 the CLT MUST map the LDPC encoded bits into twelve 4-bit QAM constellation points as defined below:

$$\{y_{0,0} y_{0,1} y_{0,2} y_{0,3}\} = \{a_3 a_2 a_1 a_0\}$$

$$\{y_{1,0} y_{1,1} y_{1,2} y_{1,3}\} = \{a_7 a_6 a_5 a_4\}$$

...

$$\{y_{11,0} y_{11,1} y_{11,2} y_{11,3}\} = \{b_{143} b_{142} b_{141} b_{140}\}$$

The mapping of these 4-bit integers to points in the complex plane is given by the figure below. Hexadecimal notation has been used to represent the 4-bit numbers  $\{y_{i,0}y_{i,1}y_{i,2}y_{i,3}\}$ .

The CLT MUST multiply the real and imaginary parts by  $1/\sqrt{10}$  to ensure that mean-square value of the QAM constellation is unity.

---

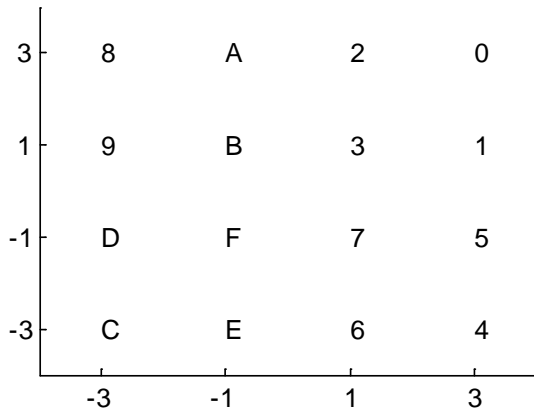

**Figure 1–24 - 16QAM Constellation Mapping of  $\{y_{i,0} y_{i,1} y_{i,2} y_{i,3}\}$**

For QPSK the CLT MUST map the LDPC encoded bits into twenty four 2-bit QAM constellation points as defined below:

$$\{y_{0,0} y_{0,1}\} = \{a_1 a_0\}$$

$$\{y_{1,0} y_{1,1}\} = \{a_3 a_2\}$$

...

$$\{y_{23,0} y_{23,1}\} = \{b_{143} b_{142}\}$$

The mapping of these 2-bit integers to points in the complex plane is given by the figure below. Hexadecimal notation has been used to represent the 2-bit numbers  $\{y_{i,0}y_{i,1}\}$ .

The CLT MUST multiply the real and imaginary parts by 1/√2 to ensure that mean-square value of the QAM constellation is unity.

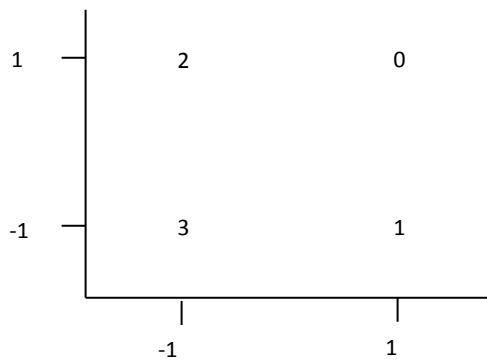

**Figure 1–25 - QPSK Constellation Mapping of  $\{y_{i,0}y_{i,1}\}$**

---



#### **1.2.13.7      *Placement of NCP Subcarriers***

The CLT MUST place the NCP subcarriers beginning from the frequency location of the highest frequency active data subcarrier of the OFDM symbol, and going downwards along active data subcarriers of the OFDM symbols before they are time and frequency interleaved.

Therefore the first subcarrier of the first NCP occupies the frequency location of the highest frequency active data subcarrier of the OFDM symbol. The term active data subcarrier is used to indicate a subcarrier that is neither excluded and that is neither a continuous pilot nor a scattered pilot. This highest frequency active subcarrier may not occur at the same frequency in every symbol owing to the presence of scattered pilots.

The OFDM symbol, prior to time and frequency interleaving at the CLT, will have subcarriers assigned to be scattered pilot placeholders. Furthermore, the NCP profile may indicate subcarriers that are to be zero-bit-loaded. The CLT MUST skip both of these types of subcarriers during the placement of NCP subcarriers.

#### **1.2.13.8      *Randomization and Interleaving of NCP Subcarriers***

The CLT MUST randomize the NCP subcarriers using the algorithm applied to the data subcarriers, described in section on data subcarrier randomization.

The CLT MUST time and frequency interleave the NCP subcarriers using the algorithm applied to data subcarriers and this is described in section interleaving.

#### **1.2.14    *Downstream Pilot Patterns***

Downstream pilots are subcarriers modulated by the CLT with a defined modulation pattern that is known to all the CNU in the system to allow interoperability.

There are two types of pilots: continuous and scattered. Continuous pilots occur at fixed frequencies in every symbol. Scattered pilots occur at different frequency locations in different symbols. Each of these pilot types for EPoC is defined in the following sections.

##### **1.2.14.4      *Scattered Pilots***

The main purpose of scattered pilots is the estimation of the channel frequency response for the purpose of equalization. There are two scattered pilot patterns, one for 4K FFT and one for 8K FFT. Although these pilots occur at different frequency locations in different OFDM symbols, the patterns repeat after every 128 OFDM symbols; in other words, the scattered pilot pattern has a periodicity of 128 OFDM symbols along the time dimension.

###### **1.2.14.4.1    *Scattered Pilot Pattern for 4K FFT***

The CLT MUST create scattered pilots for 4K FFTs in the manner described in this section.

---

Figure 1–27 shows the 4K FFT scattered pilot pattern for OFDM transmissions.

The scattered pilot pattern is synchronized to the PLC as shown in Figure 1–27. The first OFDM symbol after the PLC preamble has a scattered pilot in the subcarrier just after the highest frequency subcarrier of the PLC. Two such scattered pilots that are synchronized to the PLC preamble are marked as red circles in Figure 1–30.

The remainder of the scattered pilot pattern is linked to the scattered pilot synchronized to the PLC preamble, using the following rules:

In each symbol scattered pilots are placed every 128 subcarriers.

From symbol to symbol, scattered pilots are shifted by one subcarrier position in the increasing direction of the frequency axis. This will result in scattered pilots placed in the exclusion band and in the PLC band.

Scattered pilots are nulled in the exclusion bands; all the subcarriers in the exclusion bands are zero-valued subcarriers.

Scattered pilots are nulled when these coincide with nulled subcarriers; all nulled subcarriers are zero-valued subcarriers.

In the PLC, normal PLC signals (i.e., PLC data or the PLC preamble) are transmitted instead of scattered pilots. The CLT MUST NOT transmit scattered pilots in the PLC band.

---

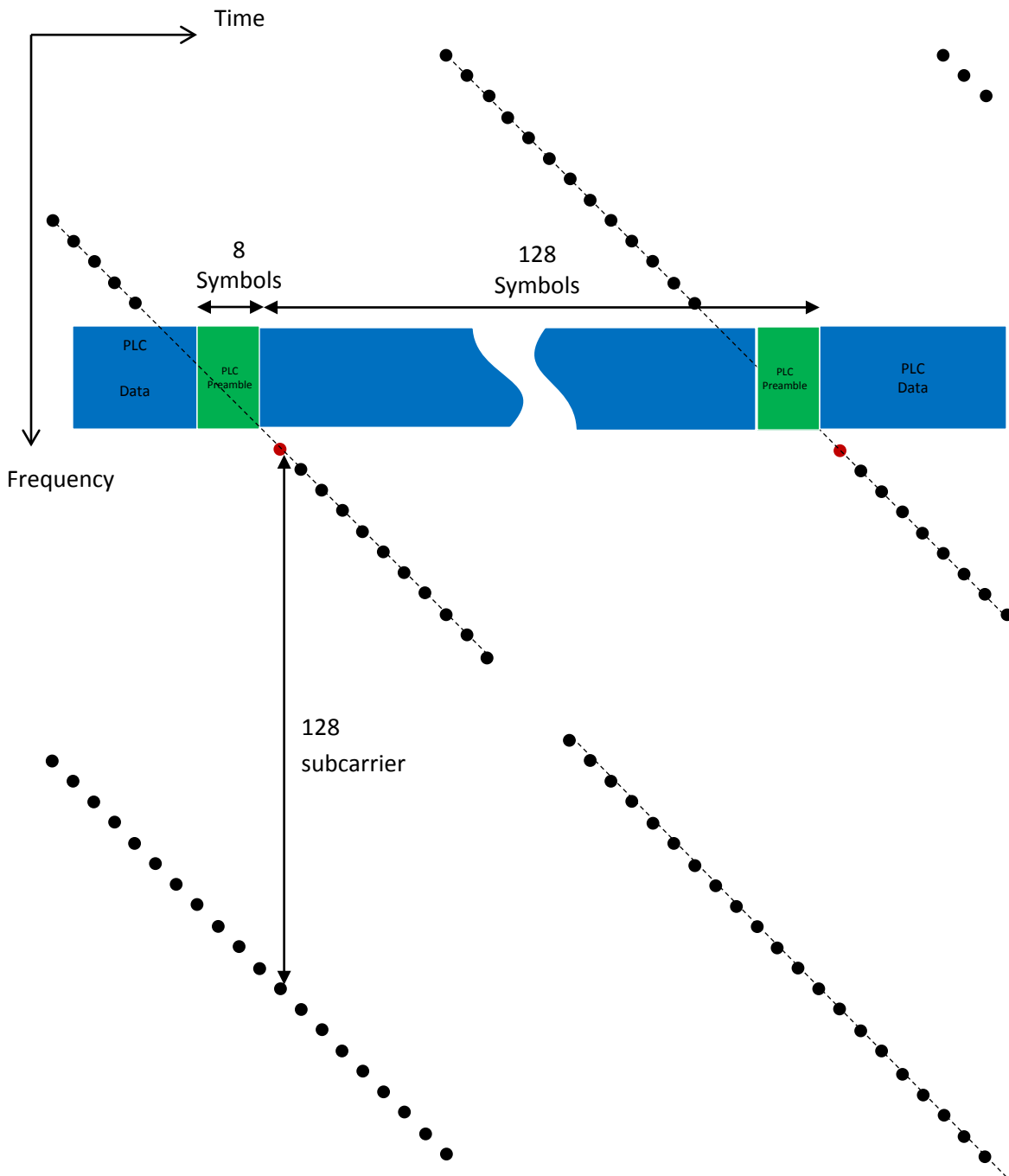

**Figure 1–26 - 4K FFT Downstream Pilot Pattern**

There are 8 preamble symbols in the PLC; for 4K FFT, there are 8 PLC subcarriers in each symbol.

---

Mathematically, the scattered pilot pattern for a 4K FFT is defined as follows. Let a subcarrier (depicted in red in the above figure just after the PLC preamble) be referred to as  $x(m,n)$ , where:

$m$  is the frequency index

$n$  is the time index (i.e., the OFDM symbol number)

The scattered pilots in the 128 symbols following (and including symbol  $n$ ) are given by:

- Symbol  $n$ :  $x(n, m \pm 128i)$ , for all non-negative integers  $i$
- Symbol  $(n+1)$ :  $x(n+1, m \pm 128i + 1)$ , for all non-negative integers  $i$
- Symbol  $(n+2)$ :  $x(n+2, m \pm 128i + 2)$ , for all non-negative integers  $i$
- ⋮
- Symbol  $(n+127)$ :  $x(n+127, m \pm 128i + 127)$ , for all non-negative integers  $i$

Each of the above locations is a scattered pilot, provided that it does not fall on a continuous pilot, on the PLC, on an exclusion zone or on a excluded subcarrier. If the scattered pilot coincides with a continuous pilot it is treated as a continuous pilot and not as a scattered pilot.

This pattern repeats every 128 symbols. That is, symbol  $(128+n)$  has the same scattered pilot pattern as symbol  $n$ .

#### *1.2.14.4.2 Scattered Pilot Pattern for 8K FFT*

The CLT MUST create scattered pilots for 8K FFTs in the manner described in this section.

Figure 1–28 shows a scattered pilot pattern that may be used for OFDM transmissions employing 8K FFT. This is used here for explanation purposes only and to help with the derivation of the scattered pilot pattern actually used in 8K FFT OFDM transmissions depicted in Figure 1–29.

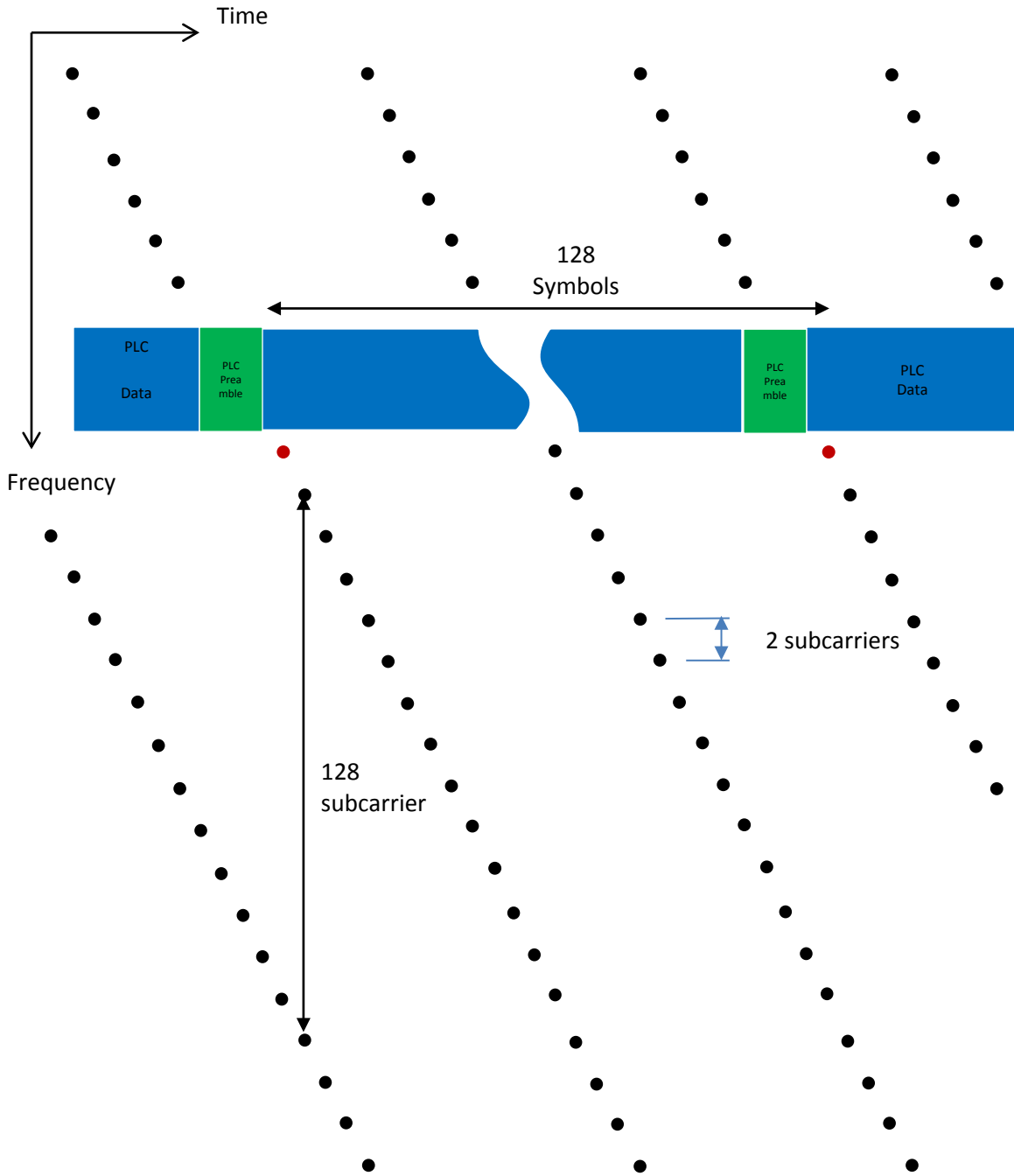

**Figure 1–27 - A Downstream Scattered Pilot Pattern for 8K FFT (for Explanation Purposes Only)**

The scattered pilot pattern is synchronized to the PLC as shown in Figure 1–27. The first OFDM symbol after the PLC preamble has a scattered pilot in the subcarrier just after the highest frequency subcarrier

of the PLC. Two such scattered pilots that are synchronized to the PLC preamble are marked as red circles in Figure 1–28.

In the case of an 8K FFT, pilots are stepped by two subcarriers from one OFDM symbol to the next. Since the pilot spacing along the frequency axis is 128, this results in a pilot periodicity of 64 in the time dimension. When Figure 1–27 and Figure 1–28 are compared, it is clear that the periodicity is half for the 8K scattered pilot pattern. However, because an 8K symbol is twice as long as a 4K symbol, the scattered pilot periodicity in terms of actual time is approximately the same for both the 4K and 8K FFTs. This allows channel estimates for 8K FFTs to be obtained in approximately the same amount of time as for the 4K FFT. However, scattered pilots for 8K FFTs do not cover all subcarrier locations and hence intermediate channel estimates have to be obtained through interpolation.

Noise can also be estimated using scattered pilots, and again, the noise at subcarrier locations not covered by scattered pilots in the 8K FFT can be obtained through interpolation. Note that this interpolation operation could fail in the presence of narrowband ingress; interpolation could also be problematic when there are excluded subcarriers.

To overcome these interpolation problems, the entire 8K scattered pilot location can be shifted by one subcarrier location after 64 subcarriers, as illustrated in Figure 1–29. This may be treated as the interlacing of two identical scattered pilot patterns. The set of purple scattered pilots are shifted one subcarrier space in relation to the set of green scattered pilots. As a result the scattered pilots cover all subcarrier locations; noise at every subcarrier location can be estimated without interpolation. Note that periodicity of the 8K FFT scattered pilot pattern is now 128, not 64.

---

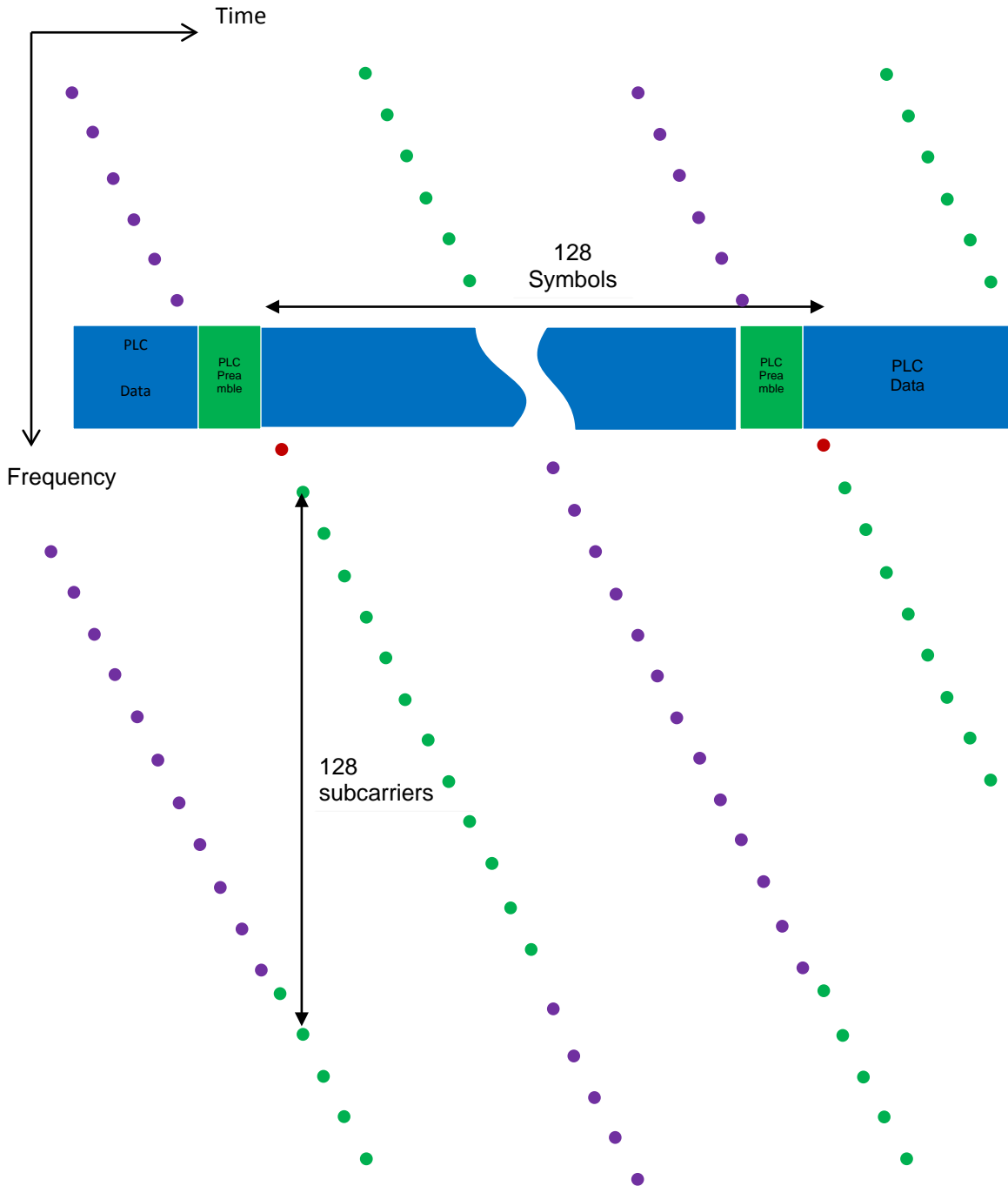

**Figure 1–28 - 8K FFT Downstream Scattered Pilot Pattern**

Mathematically, the scattered pilot pattern for an 8K FFT is defined as follows. Let the subcarrier (depicted in red in Figure 1–29 just after the PLC preamble) be referred to as  $x(m, n)$  where:

$m$  is the frequency index

$n$  is the time index (i.e., the OFDM symbol number)

The scattered pilots in the first 64 symbols following and including symbol  $n$  are given by:

Symbol  $n$ :  $x(n, m \pm 128i)$ , for all non-negative integers  $i$   
Symbol  $(n+1)$ :  $x(n + 1, m \pm 128i + 2)$ , for all non-negative integers  $i$   
Symbol  $(n+2)$ :  $x(n + 2, m \pm 128i + 4)$ , for all non-negative integers  $i$   
:  
Symbol  $(n+63)$ :  $x(n + 63, m \pm 128i + 126)$ , for all non-negative integers  $i$

The scattered pilot sequence of the next 64 symbols is the same as above, but with a single subcarrier shift in the frequency dimension.

Symbol  $(n+64)$ :  $x(n + 64, m \pm 128i + 1)$ , for all non-negative integers  $i$   
Symbol  $(n+65)$ :  $x(n + 65, m \pm 128i + 3)$ , for all non-negative integers  $i$   
Symbol  $(n+66)$ :  $x(n + 66, m \pm 128i + 5)$ , for all non-negative integers  $i$   
:  
Symbol  $(n+127)$ :  $x(n + 127, m \pm 128i + 127)$ , for all non-negative integers  $i$   
:

Each of the above locations is a scattered pilot, provided that it does not fall on a continuous pilot, on the PLC, on an exclusion zone or on a nulled subcarrier. If the scattered pilot coincides with a continuous pilot it is treated as a continuous pilot and not as a scattered pilot.

This pattern repeats every 128 symbols. That is, symbol  $(128+n)$  has the same scattered pilot pattern as symbol  $n$ .

#### **1.2.14.5 Continuous Pilots**

Continuous pilots occur at the same frequency location in all symbols and are used for receiver synchronization. Placement of continuous pilots is determined in two ways:

- a) Predefined continuous pilot placement around the PLC
  - b) Continuous pilot placement defined via PLC messages
-



Note that continuous and scattered pilots can overlap; the amount of overlap, in terms of number of carriers, changes from symbol to symbol. Overlapping pilots are treated as continuous pilots.

1.2.14.5.1 *Predefined Continuous Pilots around the PLC*

As discussed in Section 1.1.13.1, the PLC is placed at the center of a 6 MHz spectral region. Four pairs of predefined continuous pilots are placed symmetrically around the PLC as shown in Figure 1–30. The spacing between each pilot pair and the PLC are different to prevent all pilots from being impacted at the same time by echo or interference.

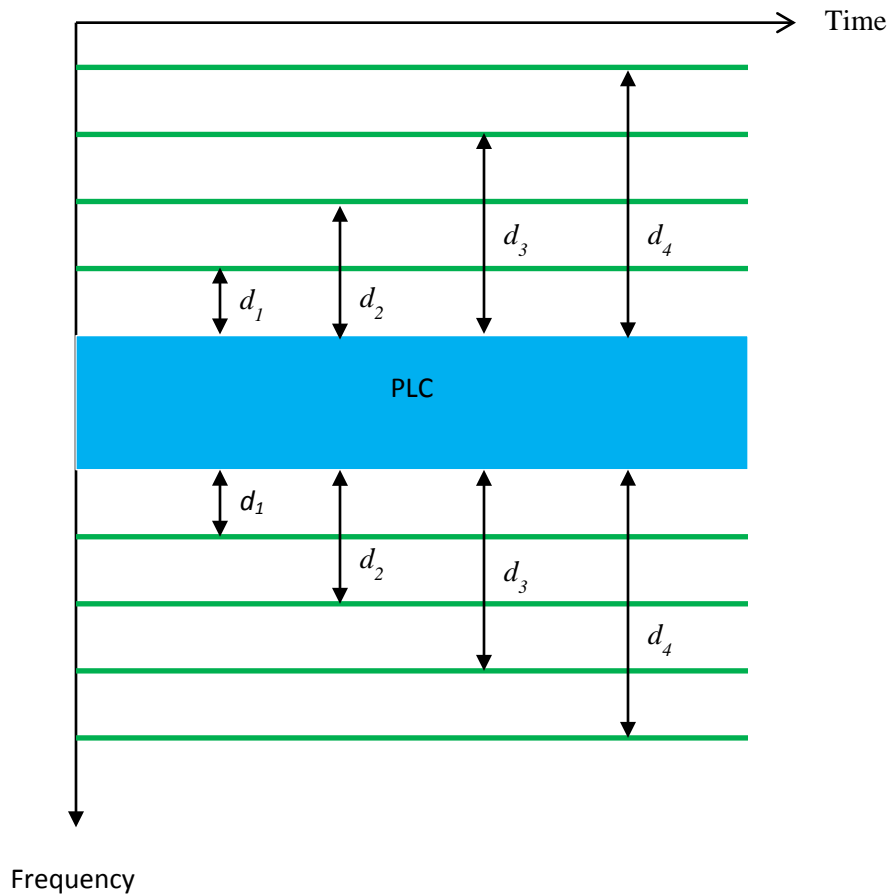

**Figure 1–29 - Placement of Predefined Continuous Pilots Around the PLC**

The locations of the continuous pilots are defined with reference to the edges of the PLC band. Hence, once the PLC has been detected, these continuous pilots also become known to the receiver.

Table 1–9 provides the values of  $d_1$ ,  $d_2$ ,  $d_3$ , and  $d_4$ , measured in number of subcarriers from the PLC edge. That is,  $d_x$  is absolute value of the difference between the index of the continuous pilot and the index of the PLC subcarrier at the PLC edge nearest to the continuous pilot. The index of a subcarrier is

the integer  $k$  of the IDFT definition given in Section 1.1.2.8. For example, let the lowest frequency subcarrier of the PLC have the IDFT index  $k$  equal to 972. Then according to Table 1–36 for the 4K FFT mode the continuous pilot nearest to this lowest frequency PLC subcarrier will have the IDFT index  $k$  of  $(972-15)=957$ . The index  $k$  of the highest frequency PLC subcarrier of this OFDM channel is 979. Hence continuous pilot that is nearest upper frequency edge of the PL has an index  $k$  of 994.

The table provides the number of subcarriers from the edge of the PLC to the placement of the pilot for the two FFT sizes. For each distance ( $d_x$ ) defined in Table 1–9, the CLT MUST place two pilots: one  $d_x$  subcarriers above and one  $d_x$  subcarriers below the edge of the PLC band.

**Table 1–10 - Subcarrier Distances for Placement of Predefined Pilots**

		$d_1$	$d_2$	$d_3$	$d_4$
<b>4K FFT</b>	<b>PLC 8 subcarriers</b>	15	24	35	47
<b>8K FFT</b>	<b>PLC 16 subcarriers</b>	30	48	70	94

**1.2.14.5.2 Continuous Pilot Placement Defined by PLC Message**

The CLT MUST define a set of continuous pilots distributed as uniformly as possible over the entire OFDM spectrum in addition to the predefined continuous pilots described in the preceding section.

The CLT MUST ensure that there are no isolated active OFDM spectral regions that are not covered by continuous pilots.

It is not practical to predefine the locations of this set of continuous pilots because of exclusion bands and excluded subcarriers.

The CLT MUST provide the continuous pilot placement definition via the PLC in accordance with messaging formats contained in the MULPI specification.

The CLT MUST adhere to the rules given below for the definition of this set of continuous pilot locations conveyed to the CNU via PLC messaging. It is noted that these rules do not apply to the eight predefined pilots.

The CLT MUST place the continuous pilots generated using these rules in every OFDM symbol, in addition to the eight predefined continuous pilots.

The CLT MUST obtain the value of  $N_{CP}$  using the following formula:

$$N_{CP} = \min \left( \max \left( 8, \text{ceil} \left( M * \left( \frac{F_{max} - F_{min}}{190e6} \right) \right) \right), 120 \right) \quad (1)$$

In this equation  $F_{max}$  refers to frequency in Hz of the highest frequency active subcarrier and  $F_{min}$  refers to frequency in Hz of the lowest frequency active subcarrier of the OFDM channel. It is observed that the number of continuous pilots is linearly proportional to the frequency range of the OFDM channel. It may also be observed that the minimum number of continuous pilots defined using the PLC cannot be less than 8, and the maximum number of continuous pilots defined using the PLC cannot exceed 120. Therefore, the total number of continuous pilots, including the predefined ones, will be in the range 16 to 128, both inclusive.

The value of  $M$  in equation (1) is kept as a parameter that can be adjusted by the CLT. Nevertheless, the CLT MUST ensure that  $M$  is in the range given by the following equation:

$$120 \geq M \geq 48 \quad (2)$$

The typical value proposed for  $M$  is 48.

The CLT MUST use the algorithm given below for defining the frequencies for the location of these continuous pilots.

**Step 1:**

Merge all the subcarriers between  $F_{min}$  and  $F_{max}$  eliminating the following:

Exclusion bands

6 MHz band containing the PLC

Known regions of interference, e.g., LTE

Known poor subcarrier locations, e.g., CTB/CSO

Let the merged frequency band be defined as the frequency range  $[0, F_{merged\_max}]$ .

**Step 2:**

Define a set of  $N_{CP}$  frequencies using the following equation:

$$F_i = \frac{F_{merged\_max}}{2N_{CP}} + \frac{i \cdot F_{merged\_max}}{N_{CP}}, \text{ for } i = 0, 1, \dots, N_{CP} - 1 \quad (3)$$

This yields a set of uniformly spaced  $N_{CP}$  frequencies:

$$\left\{ \frac{F_{merged\_max}}{2N_{CP}}, \frac{3F_{merged\_max}}{2N_{CP}}, \dots, F_{merged\_max} - \frac{F_{merged\_max}}{2N_{CP}} \right\} \quad (4)$$

**Step 3:**

Map the set of frequencies given above to the nearest subcarrier locations in the merged spectrum. This will give a set of  $N_{CP}$  approximately uniformly spaced subcarriers in the merged domain.

---

**Step 4:**

De-merge the merged spectrum through the inverse of the operations through which the merged spectrum was obtained in step 1.

**Step 5:**

If any continuous pilot is within 1 MHz of a spectral edge, move this inwards (but avoiding subcarrier locations impacted by interferences like CSO/CTB) so that every continuous pilot is at least 1 MHz away from a spectral edge. This is to prevent continuous pilots from being impacted by external interferences. If the width of the spectral region does not allow the continuous pilot to be moved 1 MHz from the edge then the continuous pilot has to be placed at the center of the spectral band.

**Step 6:**

Identify any spectral regions containing active subcarriers (separated from other parts of the spectrum by exclusion bands on each side) that do not have any continuous pilots. Introduce an additional continuous pilot at the center of every such isolated active spectral region.

In the unlikely event that the inclusion of these extra pilots results in the total number of continuous pilots defined by PLC exceeding 120, return to step 1 and re-do the calculations after decrementing the value of  $N_{CP}$  by one.

**Step 7:**

Test for periodicity in the continuous pilot pattern and disturb periodicity, if any, through the perturbation of continuous pilot locations using a suitable algorithm. A simple procedure would be to introduce a random perturbation of up to  $\pm 5$  subcarrier locations around each continuous pilot location, but avoiding subcarrier locations impacted by interferences like CSO/CTB.

The CLT MUST transmit this continuous pilot pattern to the CNU in the system using the PLC.

**1.2.14.6 Pilot Modulation**

For both continuous and scattered pilots, the CLT MUST modulate these subcarriers as described in the following section.

Continuous and scattered pilots are BPSK modulated using a pseudo-random sequence. This pseudo-random sequence is generated using a 13-bit linear feedback shift register, shown in Figure 1–31 with polynomial  $(x^{13}+x^{12}+x^{11}+x^8+1)$ .

This linear feedback shift register is initialized to all ones at the  $k=0$  index of the 4K or 8K discrete Fourier transform defining the OFDM signal (refer to Section 1.1.7). It is then clocked after every subcarrier of the FFT. If the subcarrier is a pilot (scattered or continuous), then the BPSK modulation for that subcarrier is taken from the linear feedback shift register output.

---

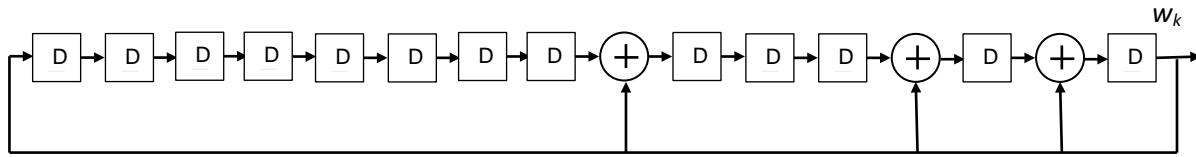

**Figure 1–30 - 13-Bit Linear Feedback Shift Register for the Pilot Modulation Pseudo-Random Sequence**

For example, let the output of the linear feedback shift register be  $w_k$ . The BPSK modulation used for the pilot would be:

$$w_k = 0: \text{BPSK Constellation Point} = 1 + j0$$

$$w_k = 1: \text{BPSK Constellation Point} = -1 + j0$$

### 1.2.14.7 Pilot Boosting

The CLT MUST multiply the real and imaginary components of continuous and scattered pilots by a real-valued number such that the amplitude of the continuous and scattered pilots is twice the root-mean-square value of the amplitude of other subcarriers of the OFDM symbol; That is, continuous and scattered pilots are boosted by approximately 6 dB with reference to other subcarriers.

**[NOTE: The following section from D3.1 PHY I01 Section 8.3]**

## 2 NEXT CODEWORD POINTERS (NCP)

### 2.2 NCP Details

#### 2.2.2 Operation

The operation of the downstream can be split between the user plane and the control plane. The *user plane* contains the data packets that are destined to the user (i.e., peer MAC entity). The *control plane* carries MAC management messages and other types of control messages such as PLC PHY-sublayer management for “low level” link negotiation, monitoring, and configuration, as well as OAM and eOAM message for higher level entity and device management.

#### 2.2.3 MAC Frame to Codewords

**[NOTE: PCS operation is already described.]**

When the codeword gets mapped across subcarriers within a symbol, there may be residual bits left over on the last subcarrier within that symbol. Since the number of residual bits may be more or less than 8, the receiver cannot simply round down to a byte boundary. To permit the downstream receiver to discard these residual bits properly, the CLT MUST make the codeword payload an odd number of bytes.

One potential set of algorithms for the CLT codeword builder and the CNU codeword receiver is as follows.

On the CLT, the algorithm is:

Number of total bytes is (header + payload + parity) and never exceeds 2025 bytes.

IF (total bytes = odd), send to FEC engine.

---

IF (total bytes = even), add a0xFF stuff byte to the payload if legal or change the number of bytes.

CLT Symbol mapper adds trailing bits to map codeword to a symbol boundary.

On the CNU, the corresponding algorithm is:

CNU extracts total bits between two NCP pointers.

IF total bits > 16200, use initial 16200 bits, and a full codeword is declared.

IF total bits = 16200, and a full codeword is declared.

IF total bits < 16200, round down to the nearest odd number of bytes.

Discard [(total bits + 8) Modulo 16] bits.

### 2.2.4 Subcarrier Numbering Conventions

Subcarriers are numbered from lower frequency to higher frequency within a FFT block. All subcarriers within the 204.8 MHz bandwidth are numbered, including the outside excluded subcarriers. Numbering starts at 0 and goes to 4095 for 4K FFT, and 0 to 8191 for 8K FFT.

Data codewords are mapped to subcarriers - prior to time and frequency interleaving - from a lower number to a higher number.

### 2.2.5 Next Codeword Pointer

When the data codewords are mapped to subcarriers within a symbol, a pointer is needed to identify where a data codeword starts. This is known as the Next Codeword Pointer (NCP). There are a variable number of NCP message blocks (MBs) on each OFDM symbol. To make sure that all subcarriers are used without reserving empty NCP MBs, the mapping of the NCP occurs in the opposite direction of the mapping for data. The relationship of NCP message blocks to the data channel is shown in Figure 2–32 (scattered pilots are not shown; last NCP MB is a CRC).

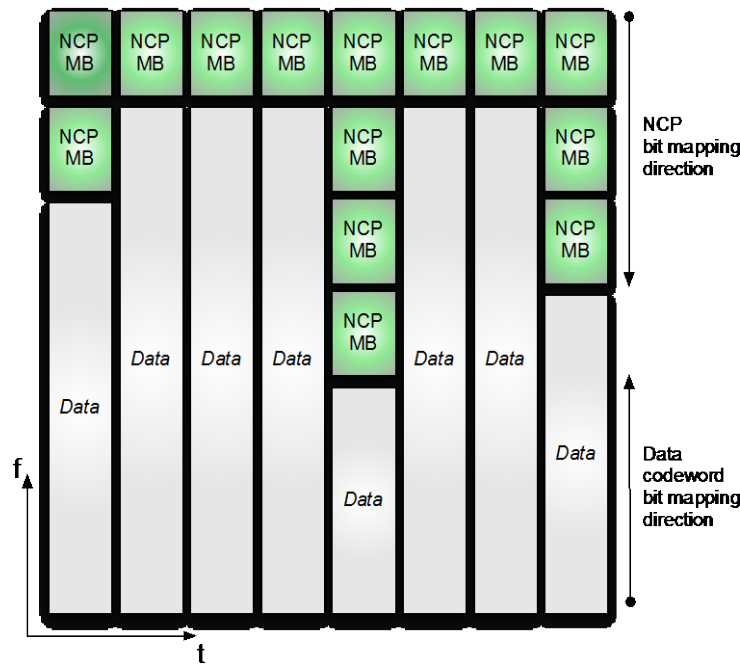
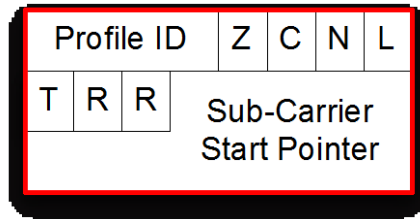

Figure 2–31 - Data and NCP Prior to Interleaving

The CLT MUST map data subcarriers within a symbol, starting from a lower frequency and proceeding to a higher frequency. The CLT MUST map NCP message blocks starting at a higher frequency and moving to a lower frequency.

**Next Codeword Ptr (NCP)  
Message Block**



*Figure 2–32 - NCP Message Block*

The format of the NCP is illustrated in Figure 2–33 and defined in **Error! Reference source not found.** Note that each three byte NCP MB is mapped into a unique FEC codeword that has a 3 byte payload with 3 bytes of FEC. The last FEC codeword is then followed by a 3 byte CRC-24-D (section 2.3.4.2) that is also placed in its own FEC block.

**Table 2–11 - NCP Parameters**

<b>Field</b>	<b>Size</b>	<b>Description</b>
<b>Profile ID</b>	<b>4 bits</b>	<b>Profile ID for the data channel</b> <i>0 = Profile A    1 -15 = reserved</i>
<b>Z</b>	<b>1 bit</b>	<b>Zero Bit Loading</b> <i>0 = subcarriers follow profile    1 = subcarriers are all zero-bit-loaded</i>
<b>C</b>	<b>1 bit</b>	<b>Data Profile Update</b> <i>0 = use even profile    1 = reserved</i>
<b>N</b>	<b>1 bit</b>	<b>NCP Update</b> <i>0 = use even profile    1 = use odd profile</i> <i>This bit is equal to the LSB of the NCP profile change count. This bit refers to the NCP profile usage for the next symbol rather than the current symbol.</i>
<b>L</b>	<b>1 bit</b>	<b>Last NCP Block</b> <i>0 = This NCP is followed by another NCP.</i> <i>1 = This is the last NCP in the chain and is followed by a CRC.</i>
<b>T</b>	<b>1 bit</b>	<b>Directed Test</b> <i>0 = this codeword is not suitable for directed profile testing by CNU's</i> <i>1 = this codeword is suitable for directed profile testing by CNU's</i>
<b>R</b>	<b>1 bit</b>	<b>Reserved</b>
<b>Subcarrier pointer</b>	<b>13 bits</b>	<b>This is the number assigned to the first subcarrier used by the codeword. The maximum value is 0x1FFE = 8190. The value 0x1FFF is reserved as a null pointer.</b>

CNU's support only one profile (i.e., Profile A) and therefore must only process NCP and referenced codewords with NCP field values Profile ID = 0 and C = 0; NCP and referenced codewords with NCP field values other than Profile ID = 0 or C = 0 must be skipped and not processed.

The NCP structure is predicated upon the following facts:

- FEC codewords are mapped continuously across successive symbols.
- The PHY can determine the first subcarrier of the first NCP message block
- The PHY can determine the first subcarrier of the data field in the current symbol.

Based upon these facts and combined with the information in the NCP fields, then

- The PHY can determine the last subcarrier of the last NCP message block
- The next subcarrier after the last NCP message block CRC is last subcarrier of the data field.

The main task of the NCP message block is to provide a reference to the appropriate profile and a start pointer for codewords. The length of a codeword is determined by the difference between the subcarrier pointer in two successive NCP message blocks.

---



Data subcarriers may contain FEC codewords or unused sub-carriers. These functions are referred to as fields in the NCP header.

The CLT MUST include one NCP within the same symbol for each start of codeword or a group of unused subcarriers that exists in that symbol. The CLT MUST include a valid Profile ID when the field is a FEC codeword field and no zero-bit-loading (Z bit not asserted).

The CLT MUST assert the Zero load bit ("Z") to mark a set of subcarriers which are not used as described in Section 2.1.4.1.

The CNU MUST ignore the Profile ID when the Z bit is asserted.

The CNU MUST use the Profile Update bit ("C") to select the odd or even data profile.

The CNU MUST use the NCP Update bit ("N") to select the odd or even NCP profile. Since the profile for NCP has to be known prior to receiving the NCP, this bit refers to the profile used for NCP in the next symbol. The CNU MUST use the NCP Update bit ("N") to select the odd or even NCP profile for the next OFDM symbol. The CLT MUST assert this bit to the same value in all the NCPs of any symbol.

The CLT MUST assert the Last bit ("L") if the NCP is the last NCP message block. The CLT MUST follow the NCP block that has its Last bit asserted with a CRC-24-D. The CRC-24-D is calculated across all message blocks in a symbol exclusive of the FEC parity bits. The CLT MUST assert the Test indicator ("T") when the subcarriers pointed to contain data that the CNU should perform a test on. See section 2.3.4.2.

A NULL NCP is defined as an NCP with the start pointer set to 0x1FFF. The usage of Null NCPs is defined in the next section. An Active NCP is an NCP that points to valid FEC codeword. Therefore, an Active NCP is an NCP in which Z-bit is Zero and the Start Pointer is not equal to 0x1FFF.

### **2.2.5.4 NCP Usage**

The CLT MUST NOT place more than 11 NCPs plus a CRC for a total of 12 NCP MBs in an 8K OFDM symbol. The CLT MUST NOT place more than 12 NCPs plus two CRCs for a total of 14 NCP MBs in any two successive 4K OFDM symbols.

In the case of an 8K FFT OFDM symbol, the 12 NCP MBs will be formed by a maximum of 10 active NCP MBs, the NULL or zero-bit-loaded NCP MB (i.e. NCP with Z-bit set to ONE) and the NCP CRC MB.

In the case of a 4K FFT, in addition to the 10 maximum active NCP MBs over two successive symbols, each of these symbols may have one additional NULL or zero-bit-loaded NCP MB, and each symbol will have a NCP CRC MB. This brings the maximum number of NCP MBs over two successive symbols to 14.

If the data FEC blocks are small in one 8K FFT OFDM symbol, there could be data subcarriers left in the symbol after the placement of 10 active NCPs and the corresponding data. In such a case the CLT MUST include an NCP describing the remaining subcarriers as zero-bit-loaded ("Z" bit asserted).

The CLT MUST NOT place more than 10 active NCPs in any two consecutive 4K OFDM symbols, i.e., the number of active NCPs in 4K FFT OFDM symbols  $n$  and  $n+1$  MUST NOT exceed 10, for any value of  $n$ .

If the data FEC blocks are small, there could be data subcarriers remaining and unused after the placement of 10 active NCPs and the corresponding data in two consecutive 4K OFDM symbols. In such a case, the CLT MUST include an NCP describing the remaining subcarriers as zero-bit-loaded ("Z" bit asserted). Furthermore, in the case of 4K FFT, if all of the 10 active NCPs are consumed by the symbol  $n$ , then the CLT MUST place an NCP in symbol  $n+1$  indicating that the unused subcarriers are zero-bit-loaded. The symbol  $n+1$  may contain a continuation of a codeword from symbol  $n$ , but no new codeword can start in symbol  $n+1$ .

For small bandwidths it is possible that there may not be a beginning or an end of a FEC codeword in a symbol. That is, a codeword may begin in the previous symbol and end in the following symbol. In such a case the CLT MUST insert a NULL NCP in the current symbol.

There may also be scenarios in which a FEC codeword may end within a symbol without leaving sufficient space to include an NCP. In this case, the CLT MUST insert a NULL NCP and move some of the data subcarriers of the FEC codeword to next OFDM symbol.

---

2.2.5.5 NCP Example



Figure 2-33 - NCP Examples

Figure 2-34 shows some examples of how the NCP field is used. This view is prior to interleaving. NCP blocks are mapped to sub-carriers starting with the first non-excluded subcarrier at the top of the spectrum and then down in frequency. After the last NCP MB is a CRC-24-D. Data is mapped to the first non-excluded subcarrier at the bottom of the frequency range and then continuing upwards in frequency.

- In symbol 1, codeword A starts at the beginning of the symbol and has a start pointer. Codeword B starts after codeword A and has a start pointer. The length of codeword A is the difference between the codeword A start pointer and the codeword B start pointer.
- In symbol 2, codeword C starts at the beginning of the symbol and has a start pointer. The length of the previous codeword B is derived from the difference between the codeword B start pointer and the codeword C start pointer, taking into account where the last data subcarrier was in symbol 1. Codeword D gets a start pointer.
- In symbol 3, codeword D continues from symbol 2 and finishes. Codeword A follows and is given a start pointer. The length of codeword D is derived from the difference between the codeword C start pointer and the codeword D start pointer, taking into account where the last data subcarrier was in symbol 2.
- In symbol 4, codeword A continues. Since there is no start pointer required, but at least one NCP block is required, an NCP block with a null pointer is included.
- In symbol 5, codeword A ends. Codeword B begins and ends. A single NCP block is created with a start pointer to codeword B.
- In symbol 6, codeword C both starts and ends. A single NCP block is created with a start pointer to codeword C.

- In symbol 7, codeword D starts and ends. There are no more data packets to send, so the remaining subcarriers are unused. A NCP block is assigned for the codeword D start pointer. A second NCP block is assigned to the start pointer of the unused subcarriers. This start pointer is used to determine the length of codeword D.
- In symbol 8, codeword A begins and ends. Codeword B begins and tried to end with a few subcarriers unused between the end of the data codeword and the end of the NCP field. Since no subcarriers can be left unused, and since an NCP would not fit, an NCP with a null pointer was inserted and some of the last few bytes of codeword B were forced into the next symbol. There is an NCP message block for codeword A, codeword B, and the null NCP.
- In symbol 9, codeword C starts a few subcarriers into the symbol. There is one NCP block for codeword C.

**[NOTE: the following subsection is from D3.1 PHY I01 Annex E]**

### 2.3.4.2 24-bit Cyclic redundancy check (CRC) Code

This section contains a 24-bits CRC code encoding, which is used for NCPs as specified in Section 1.1.14 and Initial Ranging as specified in Section **Error! Reference source not found.**

The CRC encoder generates the 24 bits parity bits denoted by  $p_0, p_1, p_2, p_3, \dots, p_{23}$  for the input bit stream  $b_0, b_1, \dots, b_{k-1}$  using the following generator polynomial:

$$g_{CRC24}(x) = x^{24} + x^{22} + x^{20} + x^{19} + x^{18} + x^{16} + x^{14} + x^{13} + x^{11} + x^{10} + x^8 + x^7 + x^6 + x^3 + x + 1$$

(127266713 in octal representation)<sup>[1]</sup>, which means in GF(2) the following equation holds

$$b_0x^{k+23} + b_1x^{k+22} + \dots + b_{k-1}x^{24} + p_0x^{23} + p_1x^{22} + \dots + p_{22}x^1 + p_{23} = 0 \text{ mod } g_{CRC24}(x).$$

This 24-bit CRC polynomial is optimized by G. Castangnoli, S. Bräuer and M. Hermann in **Error! Reference source not found.**

---