

# **RTPGE BCI Noise Analysis for Common Mode Termination & Grounding Effects**

**November 12, 2013**

**Ahmad Chini, Broadcom**  
**Mehmet Tazebay, Broadcom**

# Contributors & Supporters

---

## Contributors

Ahmad Chini, Broadcom

Jay Cordaro, Broadcom

Neven Pischl, Broadcom

Mehmet Tazebay, Broadcom

## Supporters

Stefan Buntz, Daimler

Thomas Hogenmueller, Bosch

Bryan Moffitt, Commscope

Thuyen Dinh, Pulse Electronics

Mike Gardner, Molex

Dave Dwelley, Linear Technology

Bernd Koerber, FTZ

Sterling Vaden, OCC

Todd Hermann, Commscope

Richard Mei, Commscope

Kirsten Matheus, BMW

Sasha Babenko, Molex

Benson Huang, Realtek

Mandeep Chadha, Vitesse

Sujan Pandey, NXP

Xiaofeng Wang, Qualcomm

Nirmal Warke, Texas Instruments

Michael Rucks, Delphi

Martin Huber, MD Electronics

Thomas Muller, Rosenberger

# AGENDA

---

- **Objectives & Methodology**
- **Set-up & Calibration Information**
- **3-Port Test Model & Results**
- **5-Port Test Model & Results**
- **A Simplified Link Model for EMC**
- **Conclusions**

# OBJECTIVES

---

1. Investigate the effect of test head grounding (floating) on BCI noise.
2. Analyze the effect of CM termination on CM-to-DM conversion and BCI Noise.
3. Preliminary analysis of noise for a simplified link model with CM chokes & terminations.

# METHODOLOGY

---

1. A BCI test setup was established in order to measure 3-port and 4-port VNA Transfer Functions with grounding and floating options.
2. 3-port VNA measurements were used in Agilent ADS simulations to obtain Differential Mode Transfer Functions and estimate noise for various Common Mode termination values and grounding options.
3. 5-port model generated in ADS using 3-port and 4-port VNA measurements, allowing noise analysis for various CM terminations applied on both sides of a link.
4. A simplified link model established in ADS incorporating measured CMC and CM terminations for input-referred noise analysis.

# BCI TEST SETUP

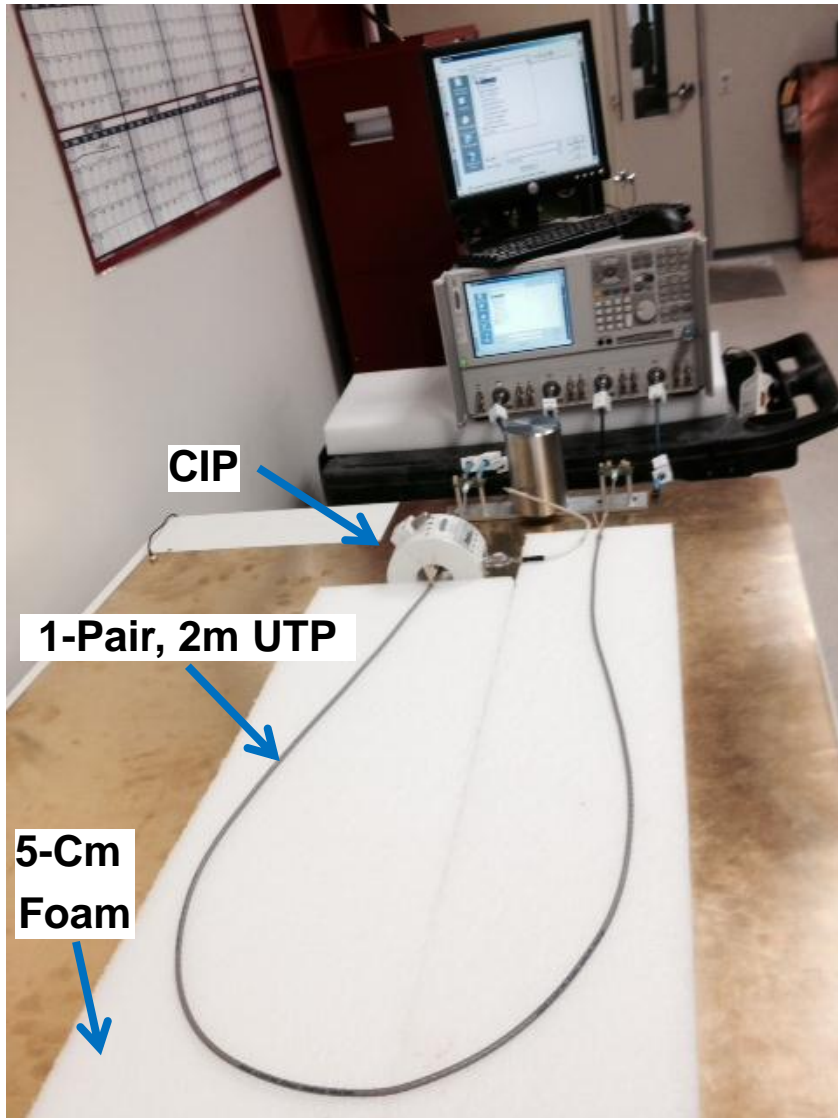

- BCI Clamp [TESEQ CIP9136A] was used to couple common mode noise.
- 3-port and 4-port VNA measurements were conducted.
- When measuring 3-port ( 2 cable ports and one clamp port), the other side of the cable was terminated with 50 $\Omega$  load (100 $\Omega$  differential).
- Test heads had optional grounding stands in order to study the effect of grounding or floating.

# TEST HEADS AND BCI CLAMP

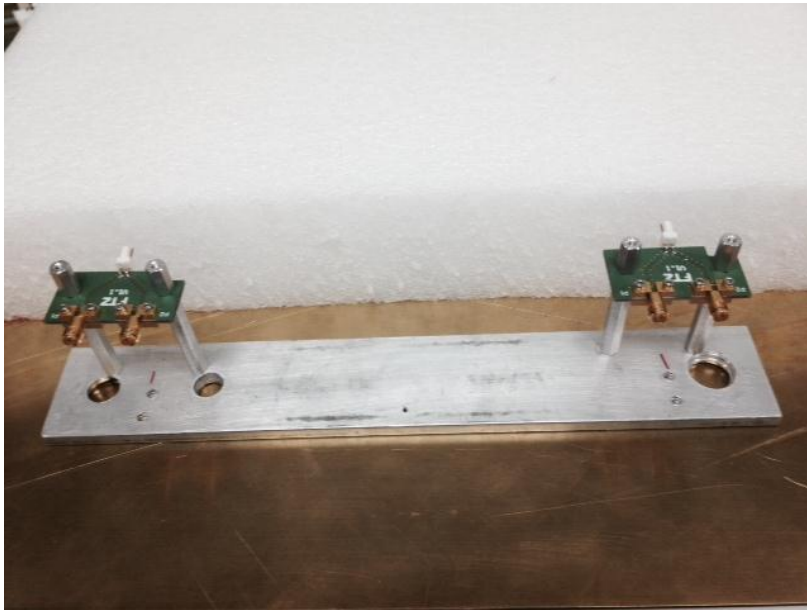

Test heads with grounding stand

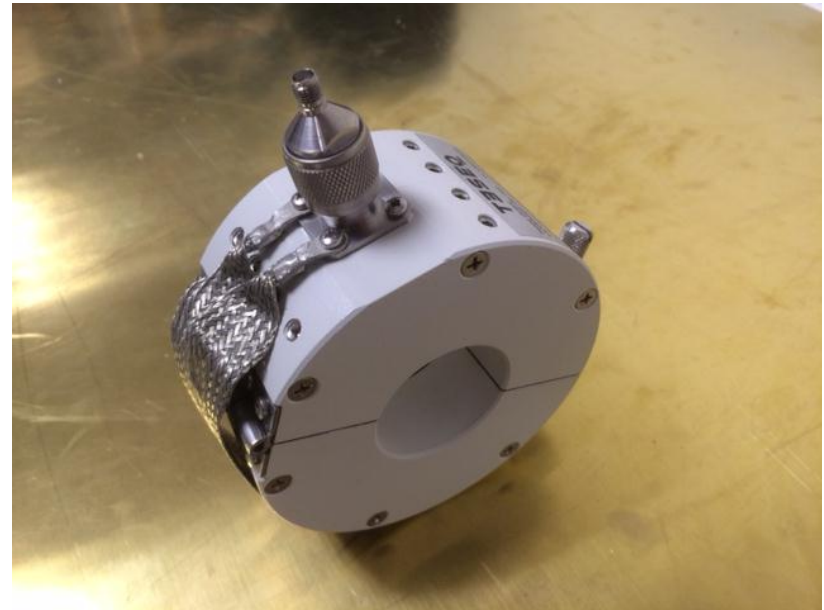

BCI clamp, TESEQ CIP9136A

# VNA + TEST HEAD CALIBRATION RESULTS

- Mechanical VNA calibration was conducted with matched coax loads, opens and thrus.
- Test heads were de-embedded to improve the measurement balance.
- The reflected balance results shown below are for grounded test heads with ports open.

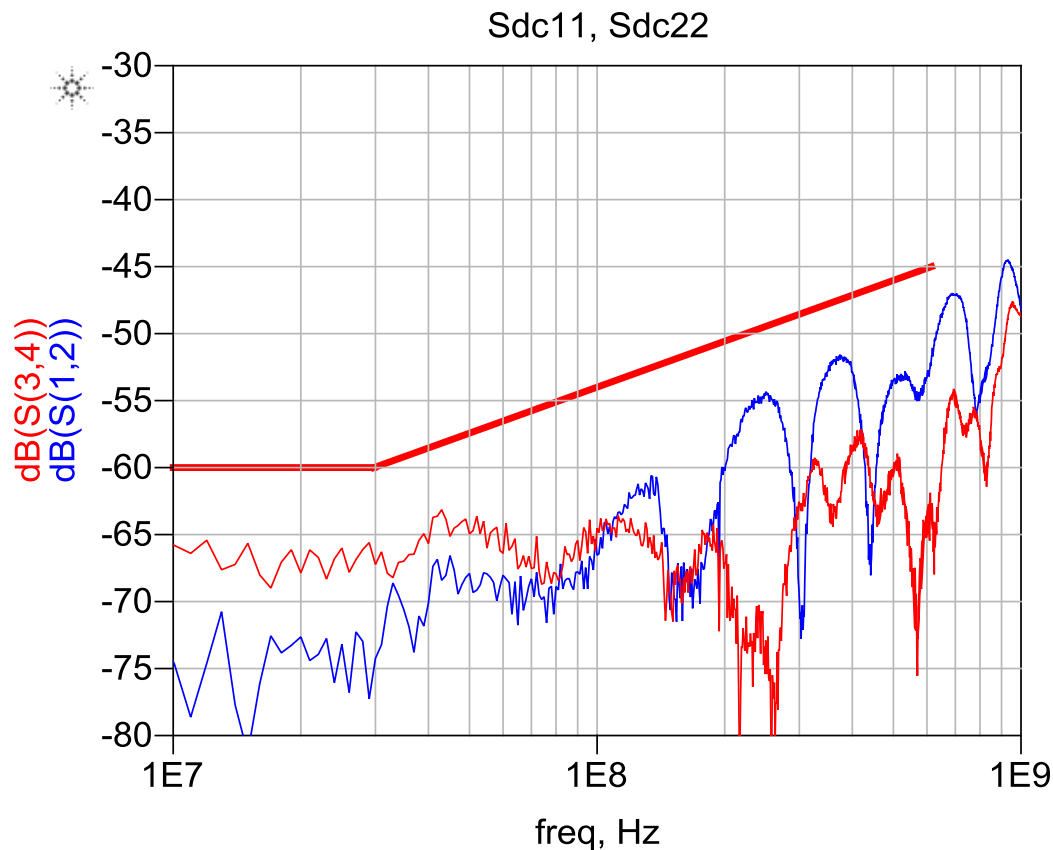



# 3-PORT BCI TEST MODEL

## SETUP INFORMATION

- S3P data was measured for a 2m 1-pair UTP cable with three different test head configurations;
  1. Test heads grounded on both sides
  2. Test heads grounded on clamp side and floating on the other side
  3. Test heads floating on both sides
- The measured S3P data was then used in Agilent ADS to simulate for various CM termination values. The CM termination value ( $X$ ) varied on the clamp side of the cable which is connected to the VNA.

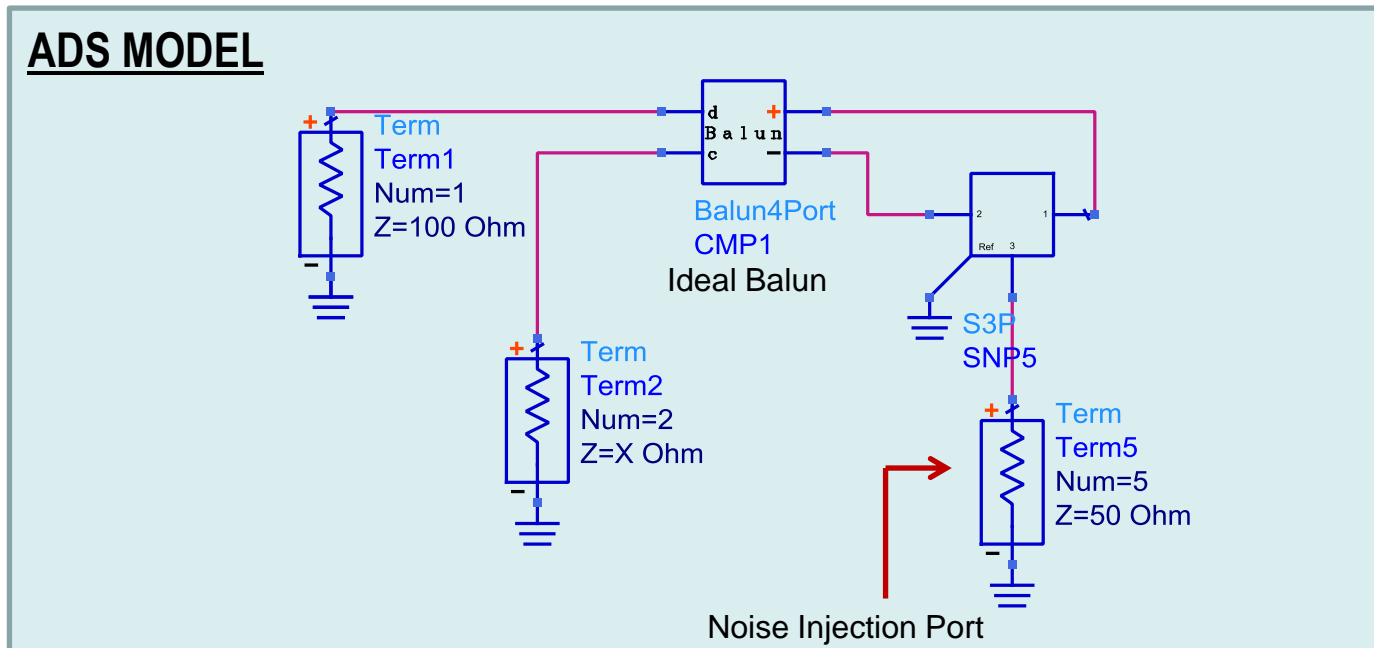

# CM & DM TRANSFER FUNCTIONS

## CASE #1: TEST HEADS ARE GROUNDED ON BOTH SIDES

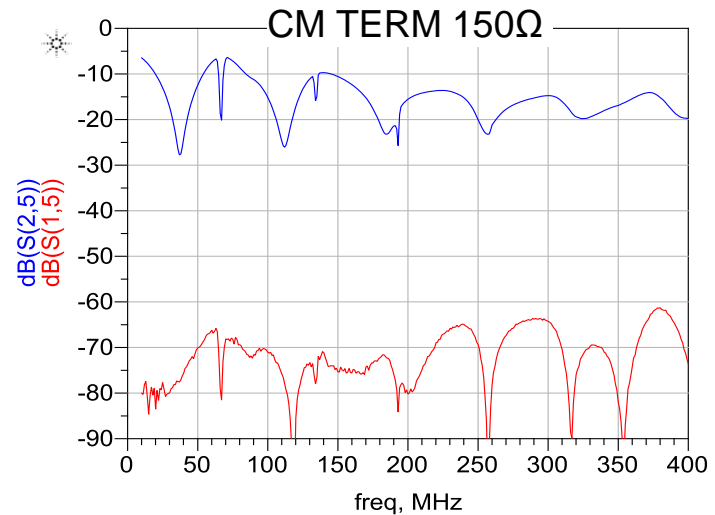
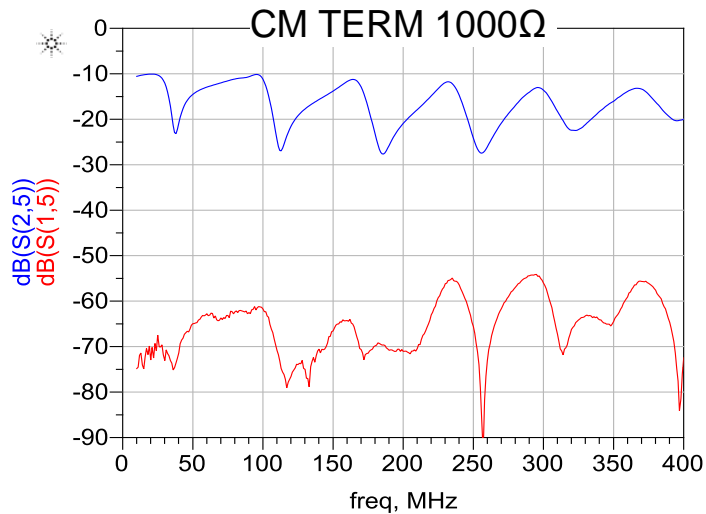
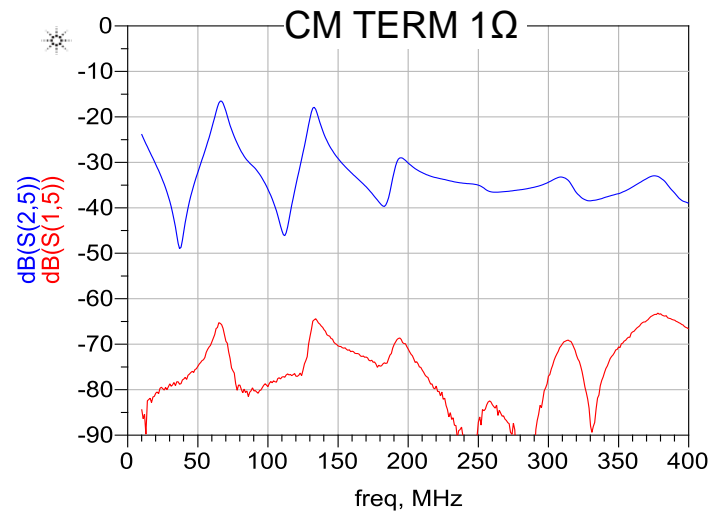
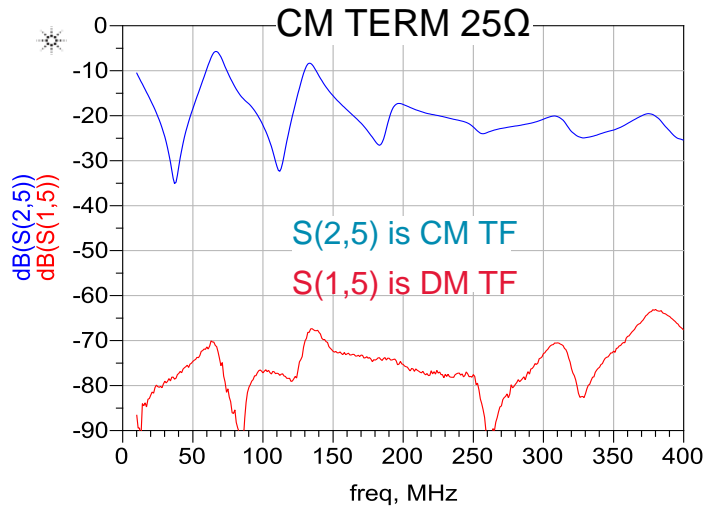

# CM & DM TRANSFER FUNCTIONS (cntd.)

## CASE #2: TEST HEAD IS GROUNDED ON THE CLAMP SIDE AND FLOATING ON THE OTHER SIDE

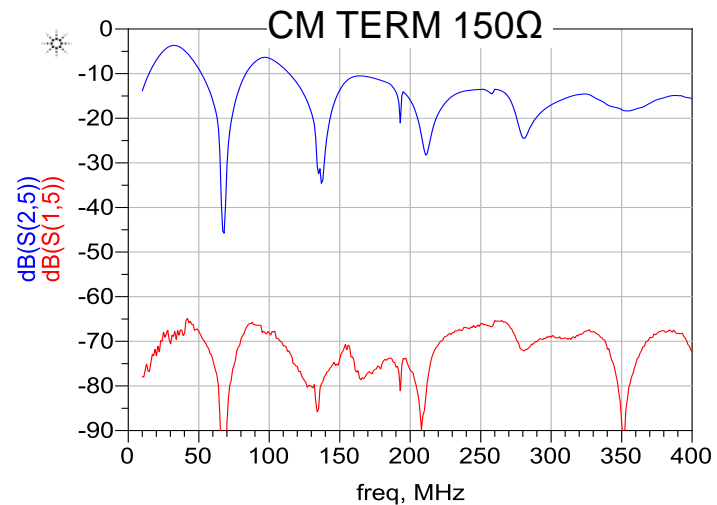
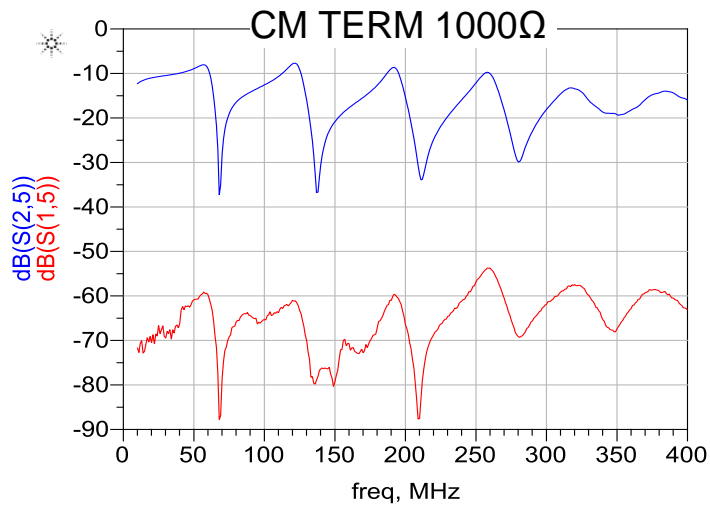
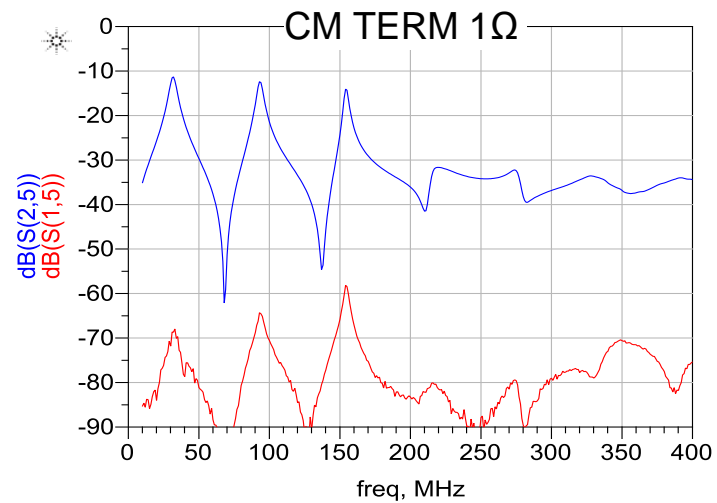
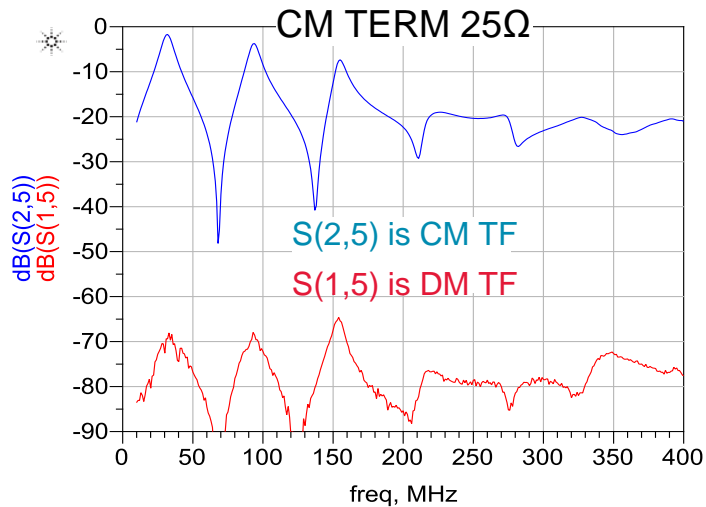

# CM & DM TRANSFER FUNCTIONS (cntd.)

## CASE #3: TEST HEADS ARE FLOATING ON BOTH SIDES

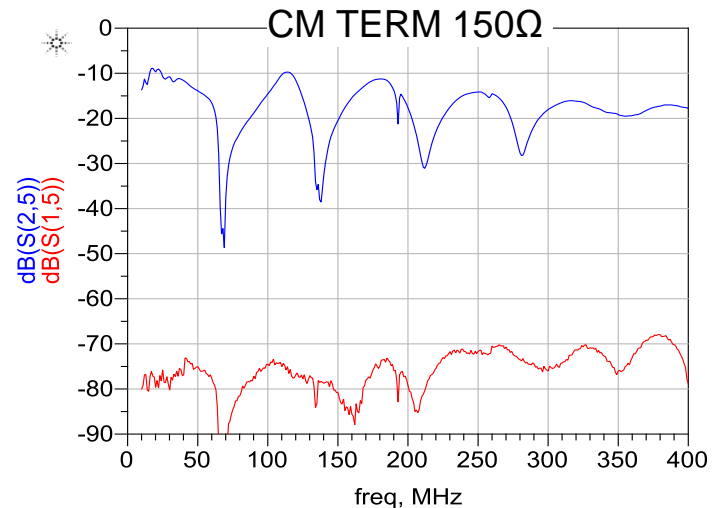
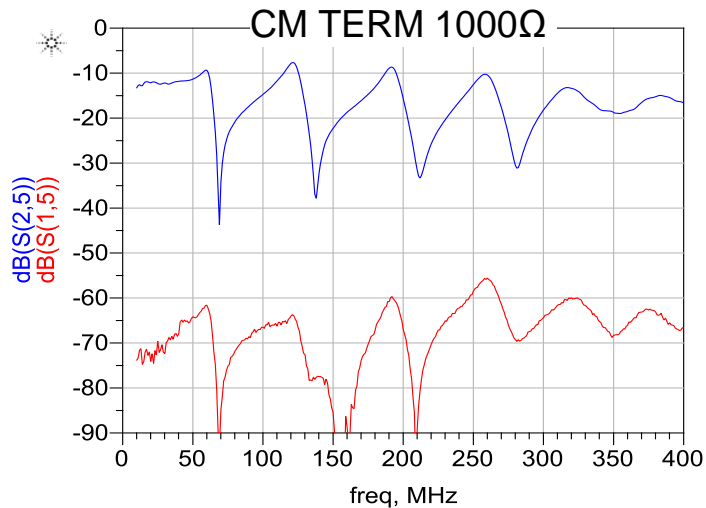
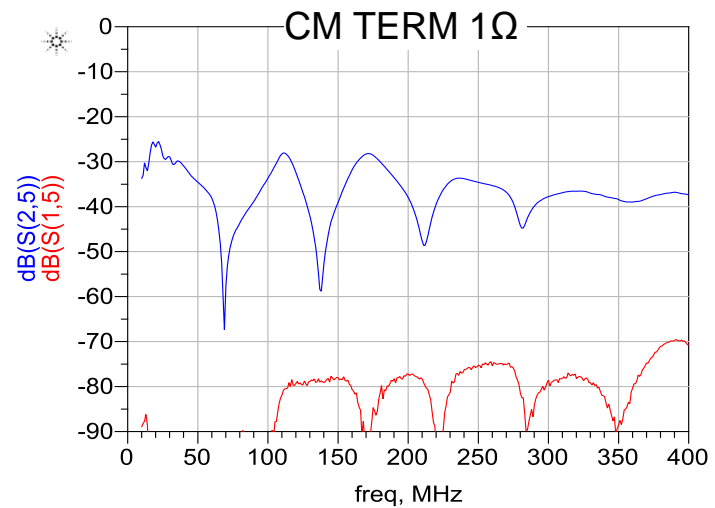
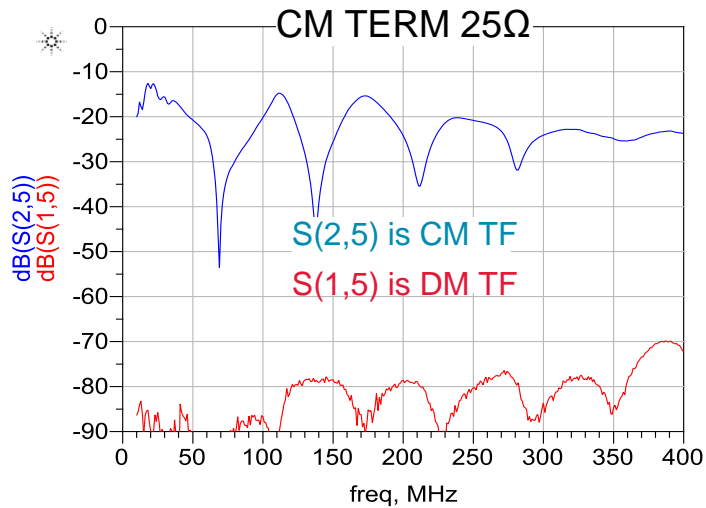

# BCI NOISE ESTIMATION METHOD

- Based on the VNA DM Transfer Function, the differential mode noise is estimated as the following:

$$V_{DM} \text{ (mVpp)} = 2\sqrt{2} * \sqrt{2} * 50\Omega * I_{\text{test}} \text{ (mA)} * \left| \frac{S_{ds15}}{H_C(f)} \right|$$

where;

$I_{\text{test}}$  : BCI test level in mA (RMS)

$S_{ds15}$  : Differential Mode Transfer Function (in linear scale)

$H_C(f)$  : BCI Clamp Transfer Function (in linear scale)

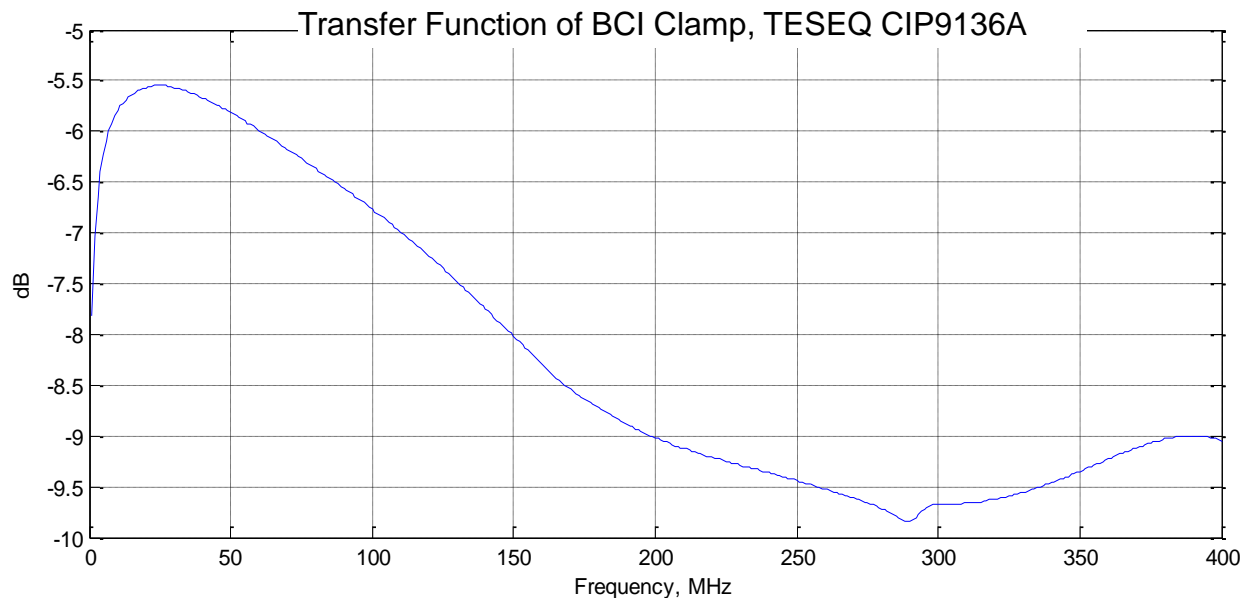

\* Clamp TF was obtained using Teseq 50Ohm calibration tool

# DIFFERENTIAL NOISE FOR $I_{\text{test}} = 200\text{mA (RMS)}$ & $Z_{\text{CM}} = 1\Omega$

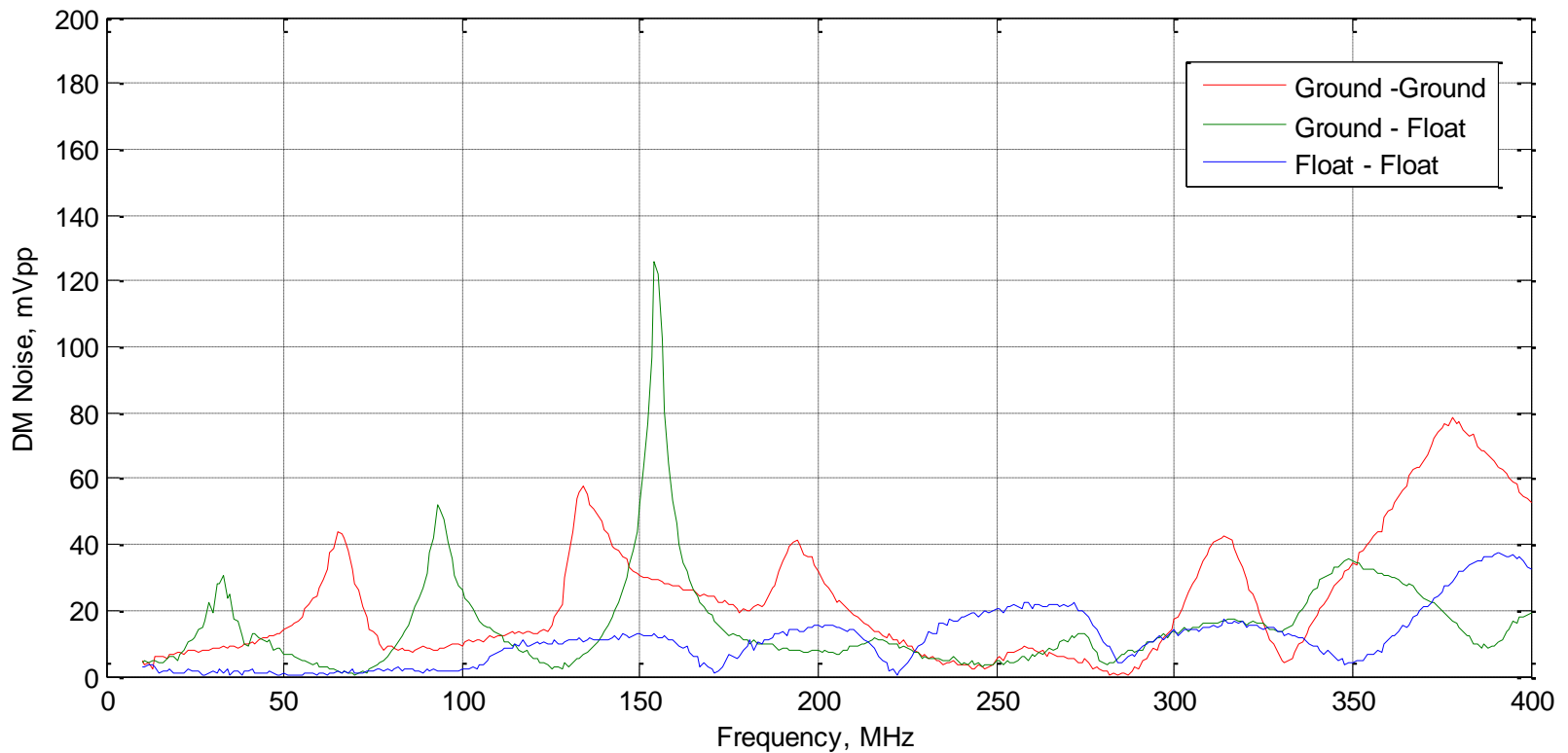

- DM noise shown above are for three grounding options of test heads

# DIFFERENTIAL NOISE FOR $I_{\text{test}} = 200\text{mA (RMS)}$ & $Z_{\text{CM}} = 25\Omega$

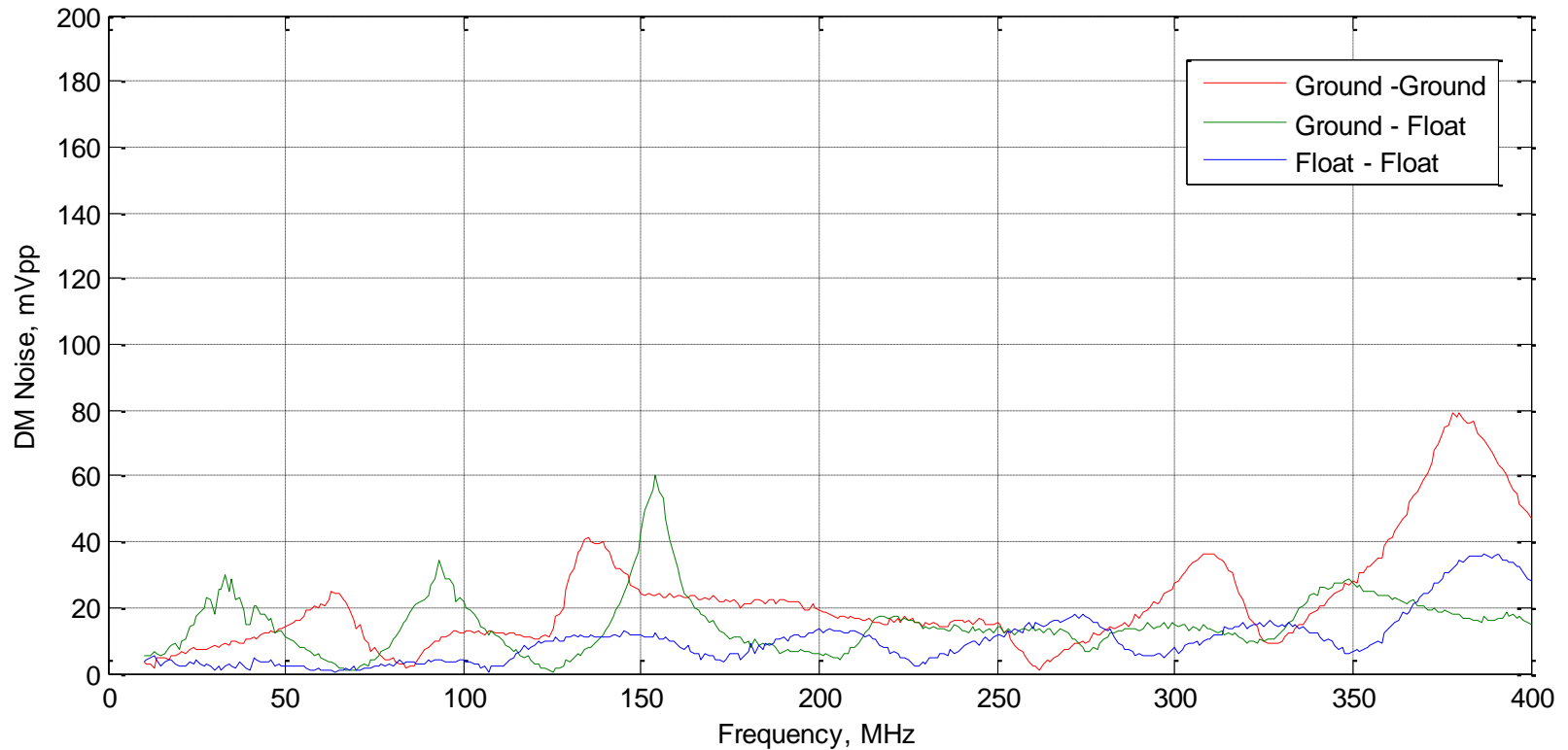

- DM noise shown above are for three grounding options of test heads

# DIFFERENTIAL NOISE FOR $I_{\text{test}} = 200\text{mA (RMS)}$ & $Z_{\text{CM}} = 150\Omega$

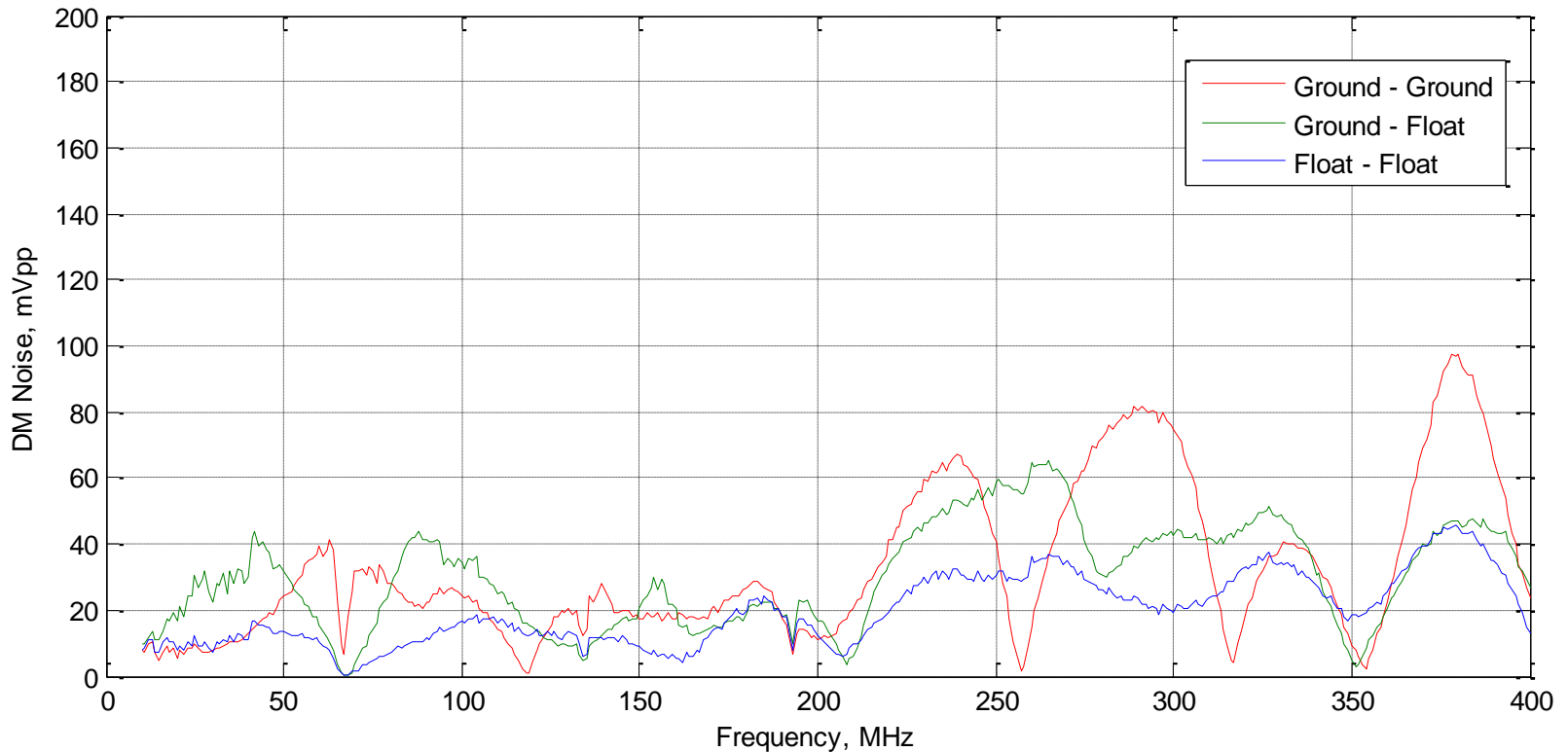

- DM noise shown above are for three grounding options of test heads



# DIFFERENTIAL NOISE FOR $I_{\text{test}} = 200\text{mA (RMS)}$ & $Z_{\text{CM}} = 1000\Omega$

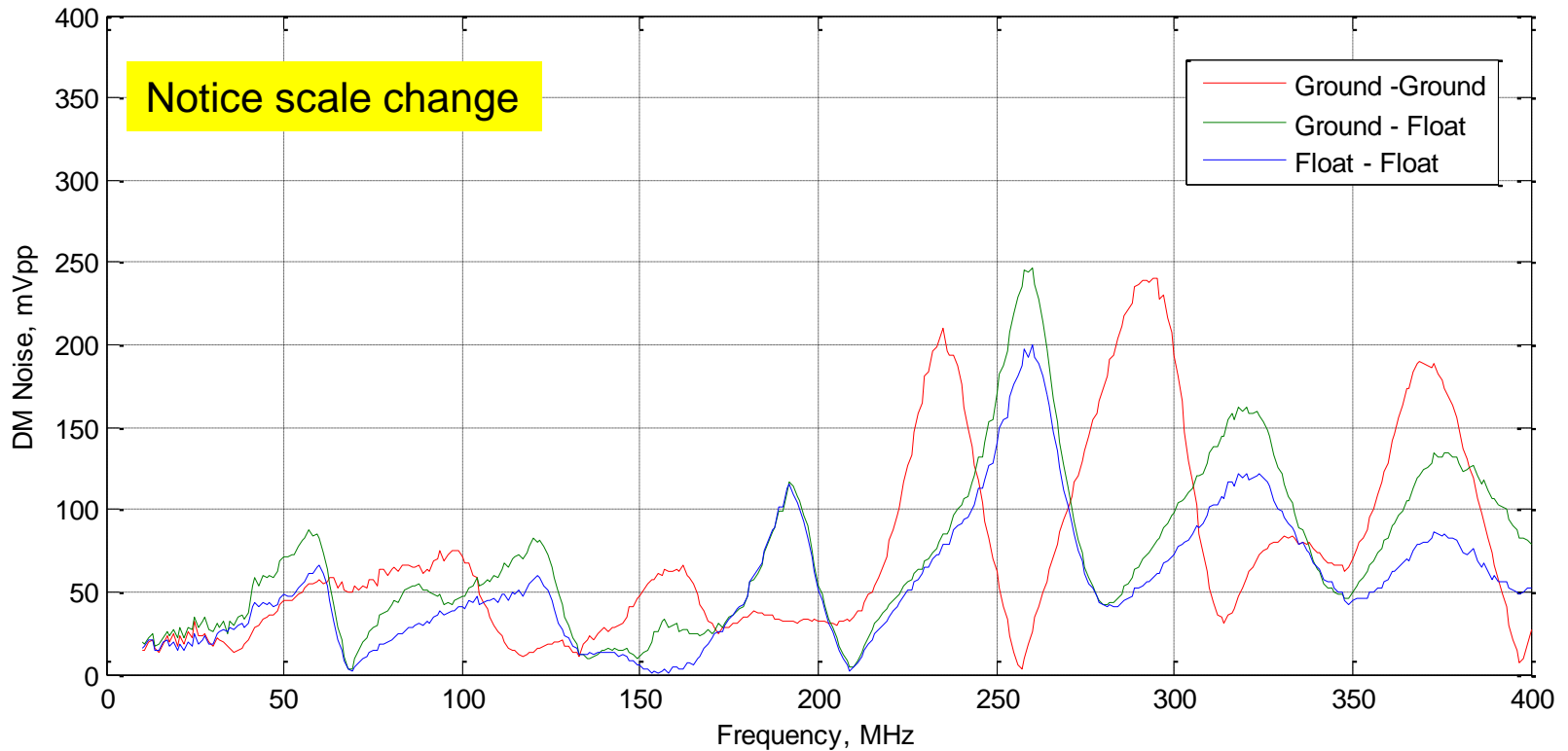

- DM noise shown above are for three grounding options of test heads

# 5-PORT BCI TEST MODEL

## SETUP INFORMATION

1. S5P generated combining cable S4P (with BCI clamp present) and two S3P (one cable end and clamp port) measurements.
2. Port-2 and port-4 are for CM terminations. The termination value (X) is varied in ADS simulations.

## ADS MODEL

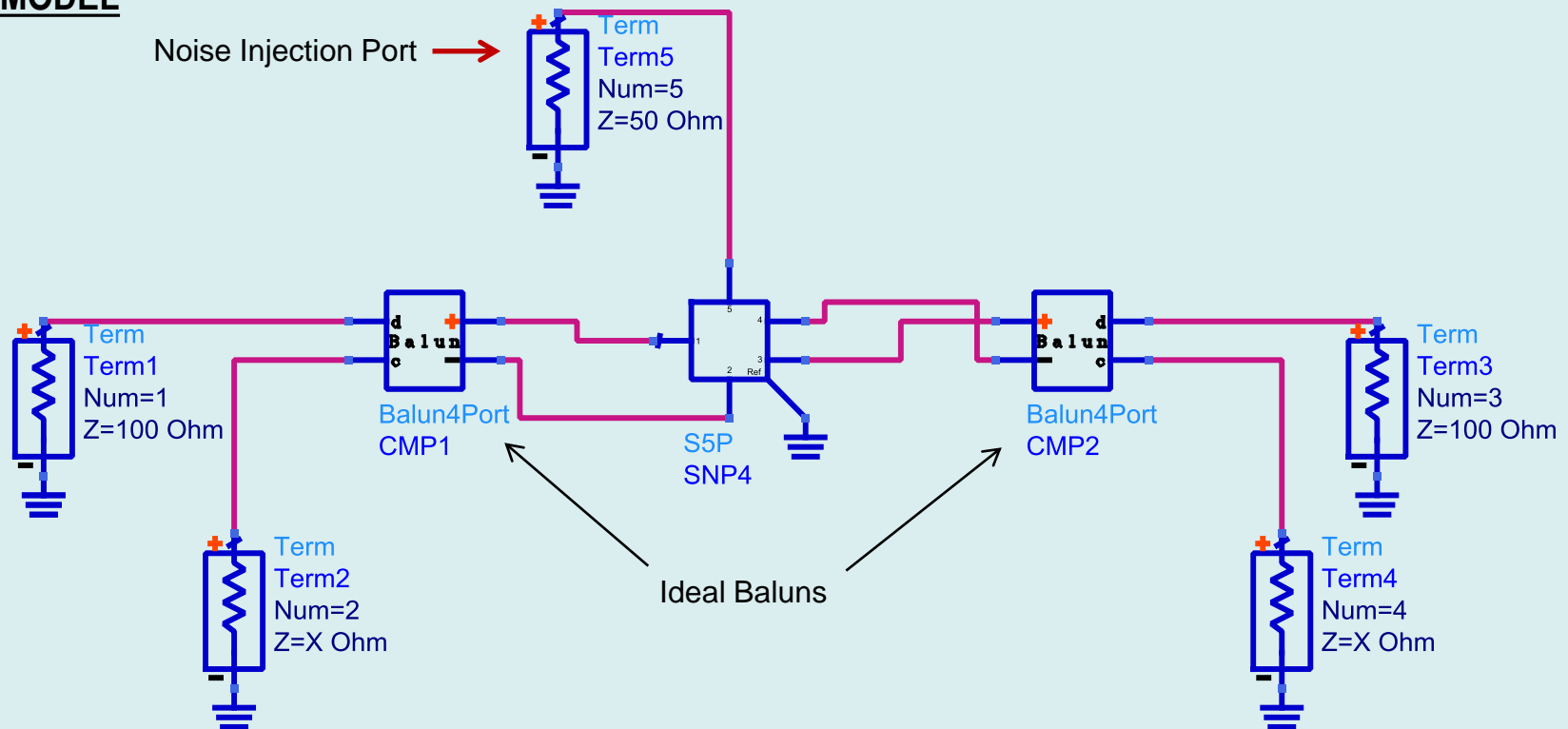

# DIFFERENTIAL NOISE FOR $I_{\text{test}} = 200\text{mA}$ (RMS) and VARIOUS CM TERMINATIONS ON BOTH SIDES OF THE CABLE

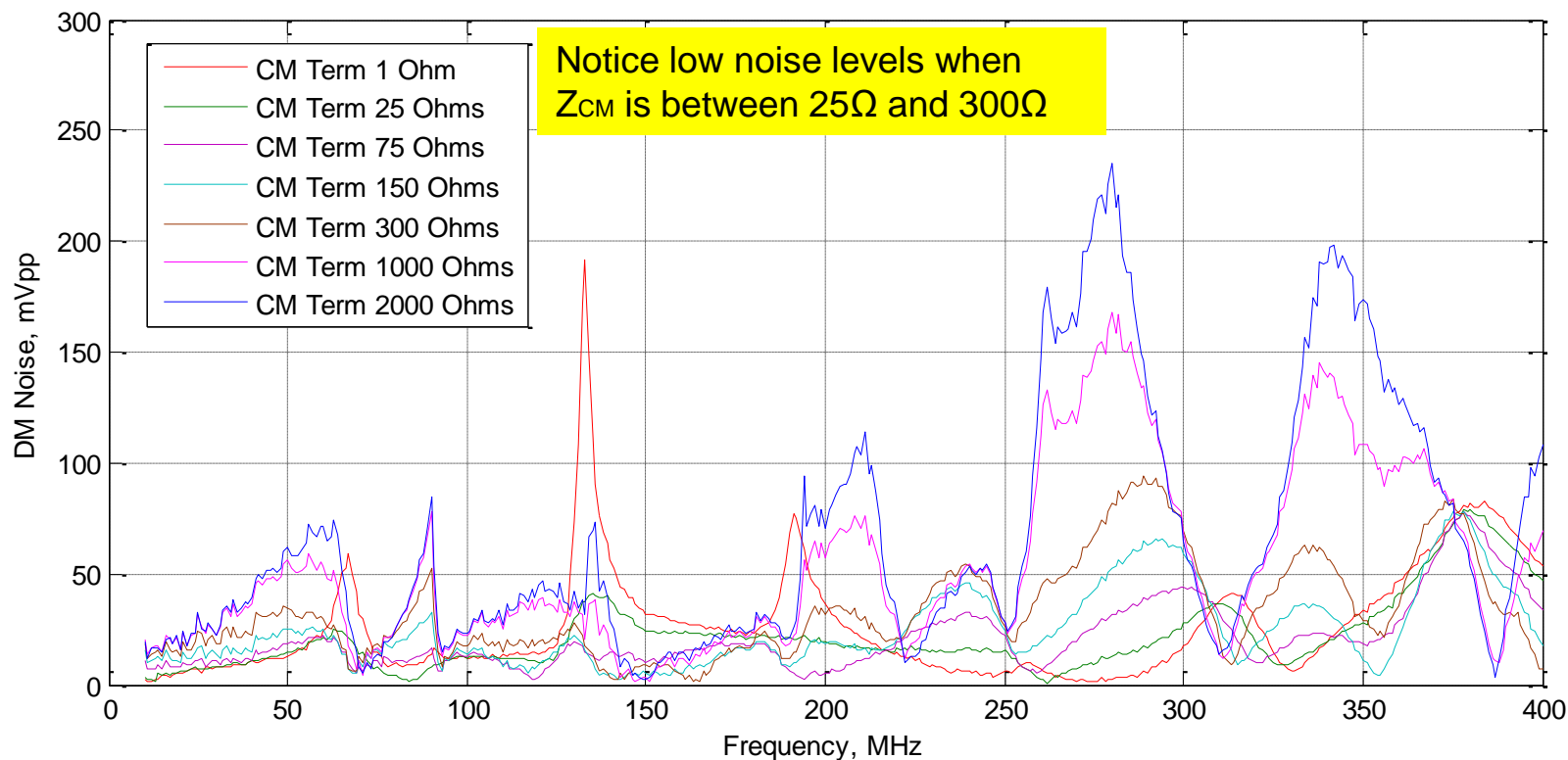

- CM termination is applied on both grounded sides.
- To avoid high noise levels, CM termination should not be too high or too low.
- The results suggest a CM termination between 25 and 300 Ohms.

# SIMPLIFIED LINK MODEL WITH CM CHOKES AND TERMINATION

## SETUP INFORMATION

1. Noise estimated using ADS simulation with a measured CMC (S4P) incorporated into the 5-port BCI test model.
2. Resistors “R” are used to terminate all the single ends of the cable to the ground (CM termination of the cable).
3. PHY is modeled with  $100\Omega$  DM and  $25\Omega$  CM terminations.

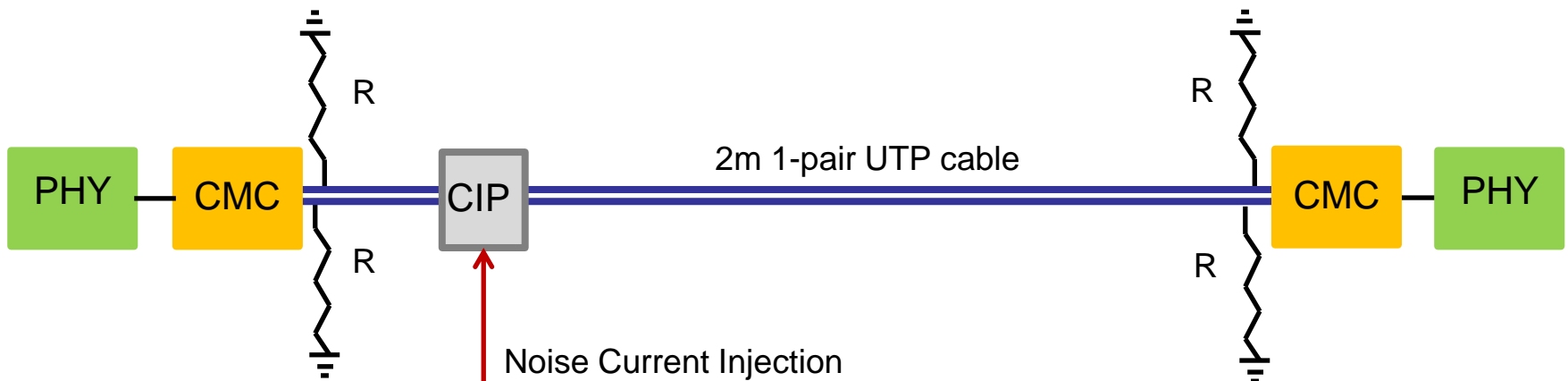

# DIFFERENTIAL NOISE @ PHY INPUT USING THE SIMPLIFIED LINK MODEL

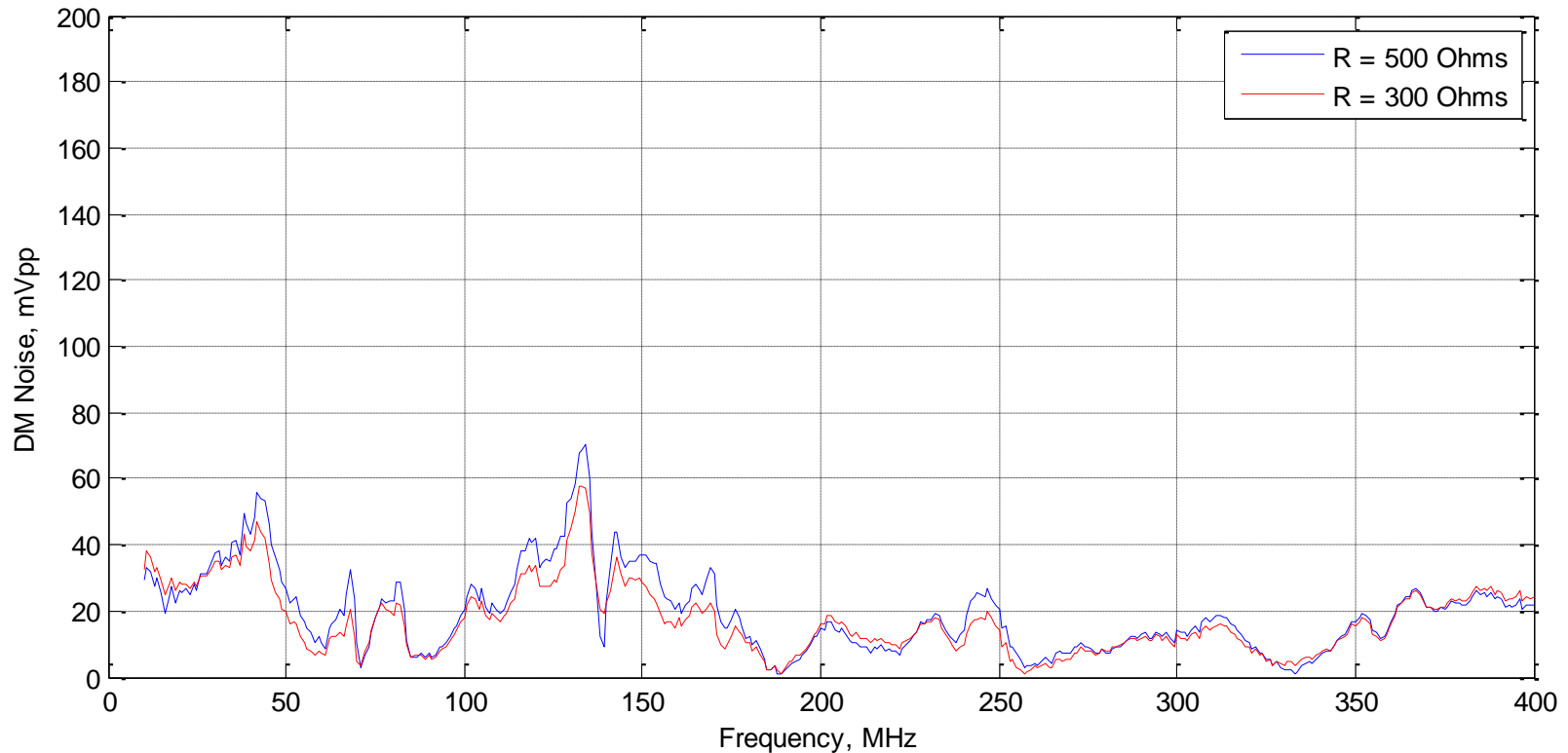

- Noise is seen below 70mV with termination resistors of up to 500Ohms and  $I_{test}=200\text{mA}$  (RMS).
- Note that CM termination is  $R/2$  in parallel with the CMC CM impedance.

# CONCLUSIONS

---

- **Grounding Effects for the Test Heads**

- Comparing noise results for grounded and floating test heads, show lower noise for floating case. Notice that when test heads are floating, connection to ground plane is established through VNA 3<sup>rd</sup> port that is connected to BCI clamp. The BCI clamp ground is connected to the brass ground plane.

- **CM Termination Effect**

- As expected, a proper choice of CM termination helps limiting the input differential noise.

- **BCI Noise Results**

- With BCI test current of 200mA (RMS), noise is seen below 100mVpp when proper CM termination is used.
- At 100mA test level, the noise is scaled down below 50mVpp.