

Characteristics of pattern in daw_3bs_01_0317

Pete Anslow, Ciena

IEEE P802.3bs Task Force, Vancouver, March 2017

Introduction

[dawe_3bs_01_0317](#) proposes to modify the SSPRQ test pattern by changing the first seed from 0x00000002 to 0x022A0ED0.

This contribution provides the characteristics of the resulting pattern.

Baseline wander

Previous NRZ contributions have used a “baseline wander” parameter

This was defined as:

Baseline wander is the instantaneous offset (in %) in the signal generated by AC coupling at the Baud rate / 10,000.

For PAM4, the eye height is 1/3 that of NRZ so the baseline wander parameter is defined as:

Baseline wander is the instantaneous offset (in %) in the signal generated by AC coupling at the Baud rate / 30,000.

Clock content

The “clock content” parameter is defined here as:

Create a function which is a 1 for a transition and a 0 for no transition and then filter the resulting sequence with a corner frequency of **Baud/6641** or **Baud/13281**.

This analysis defines a transition as one of three possibilities (as per [healey_3bs_01_1115](#)):

- Symmetrical transitions through the signal average
- Transitions through the signal average
- All transitions

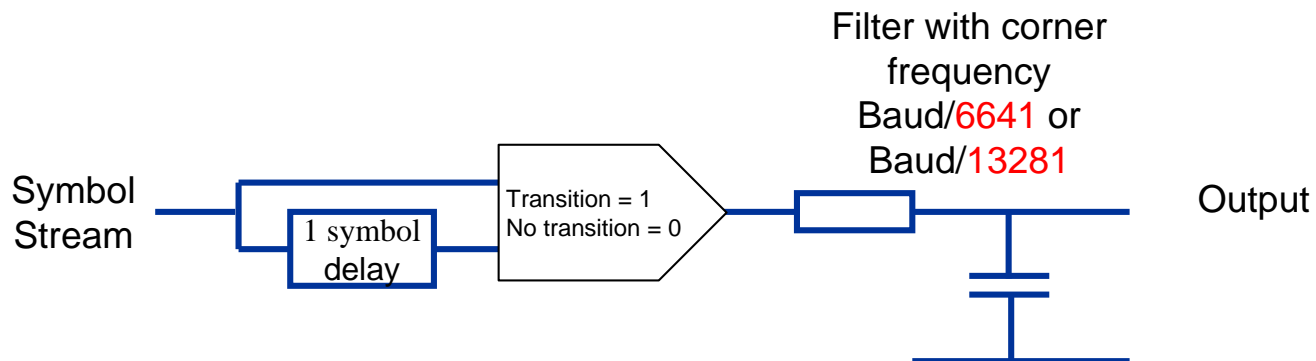

Clock content illustration

Symmetrical
transitions
through the
signal average

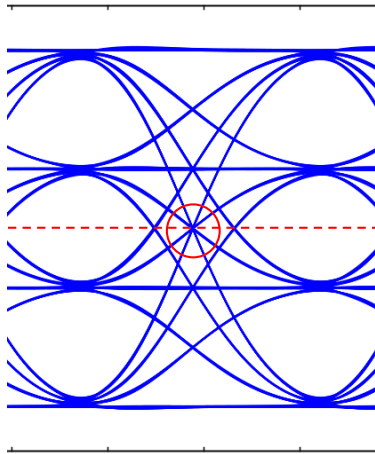

Transitions
through the
signal average

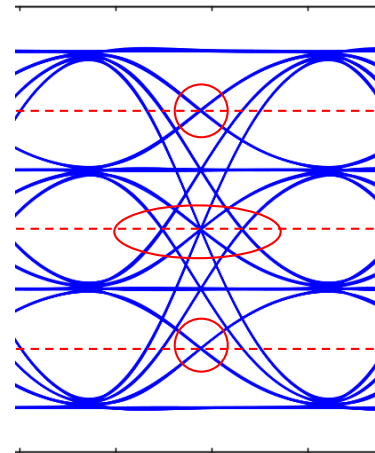
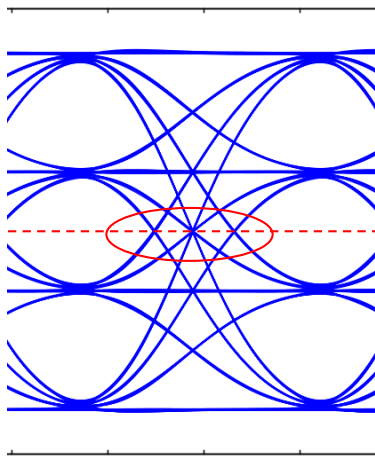

All transitions

dawe_3bs_01_0317 baseline wander

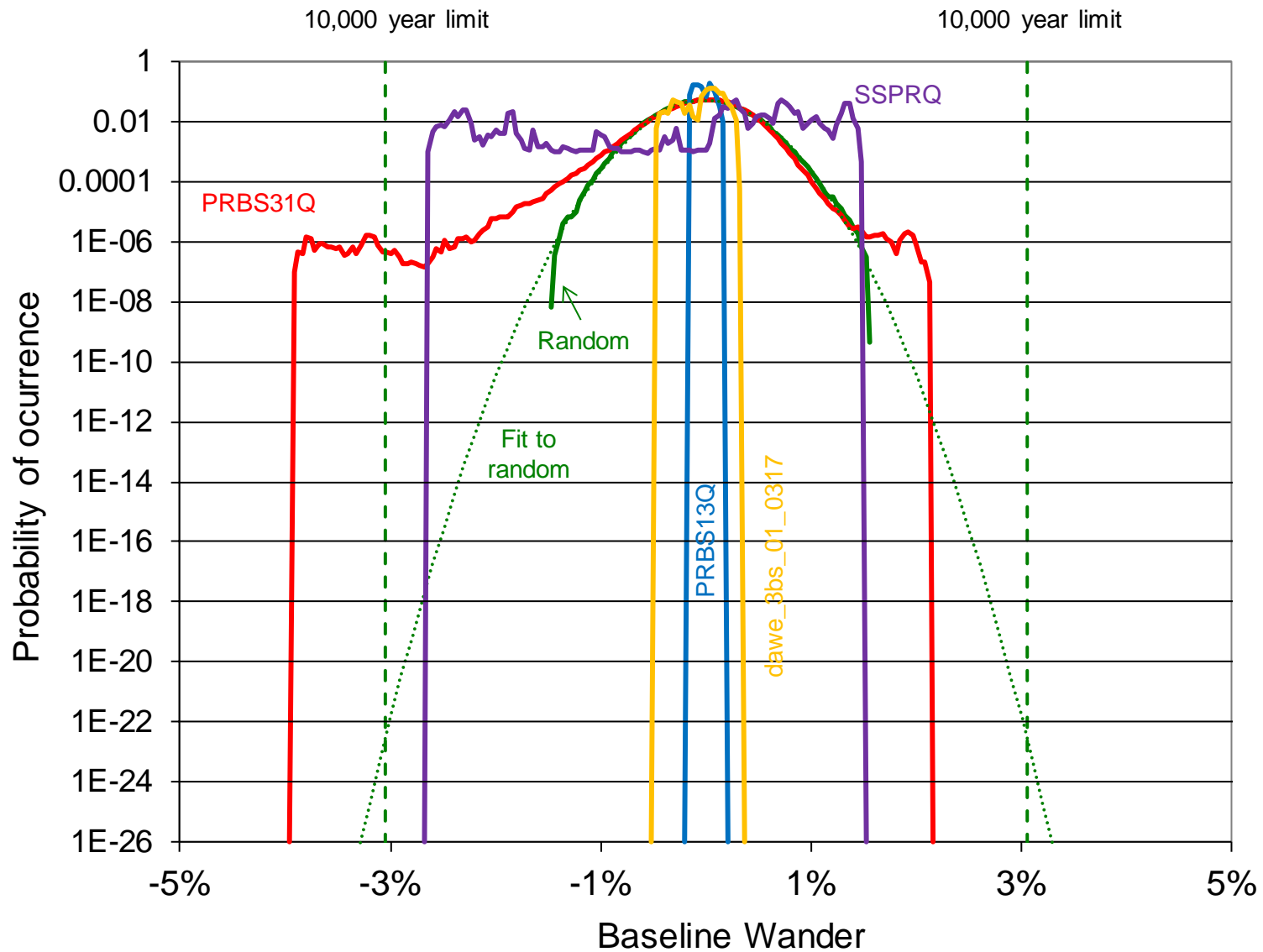

clock, sym trans through ave, 6641

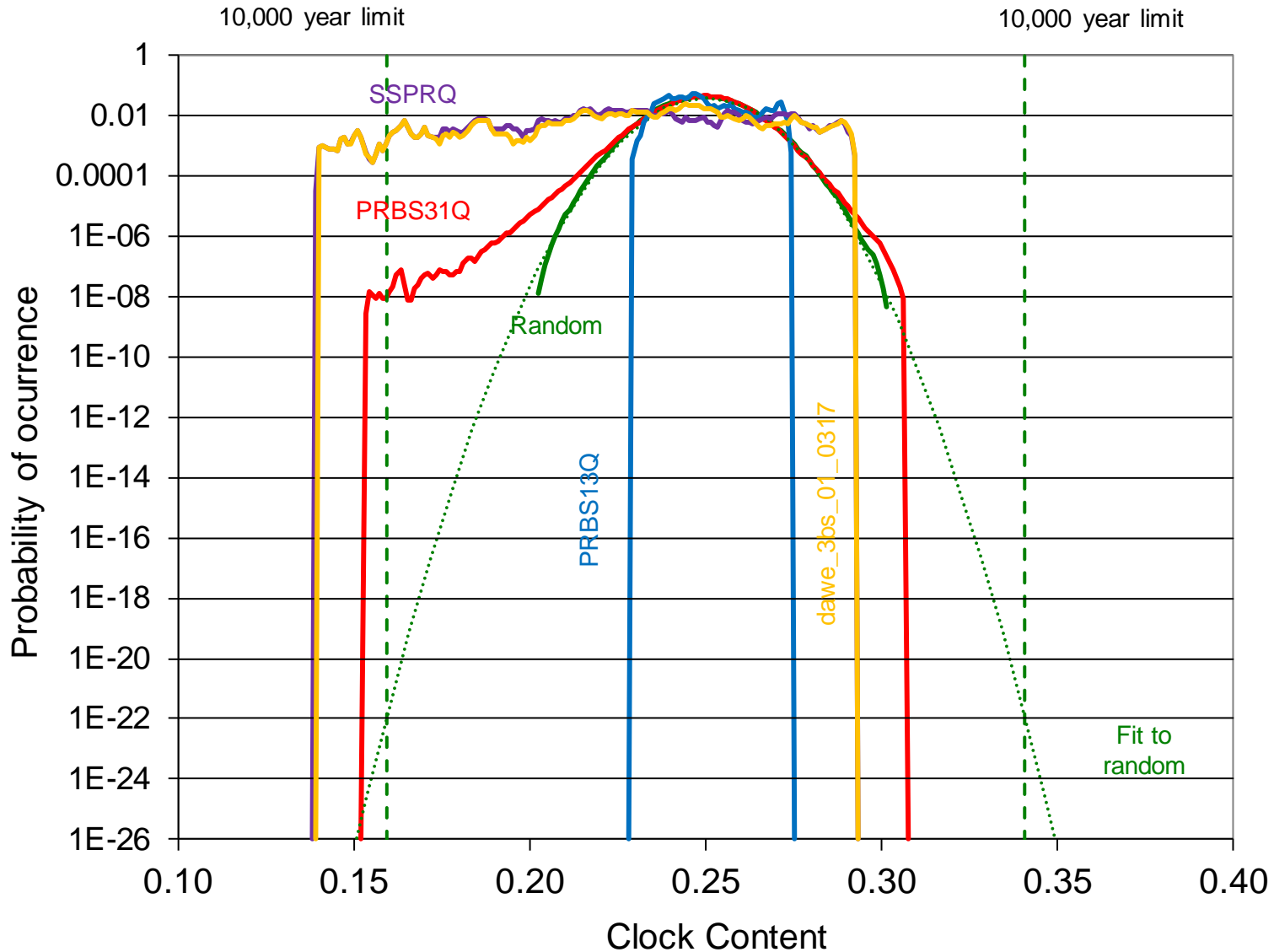

clock, trans through ave, 6641

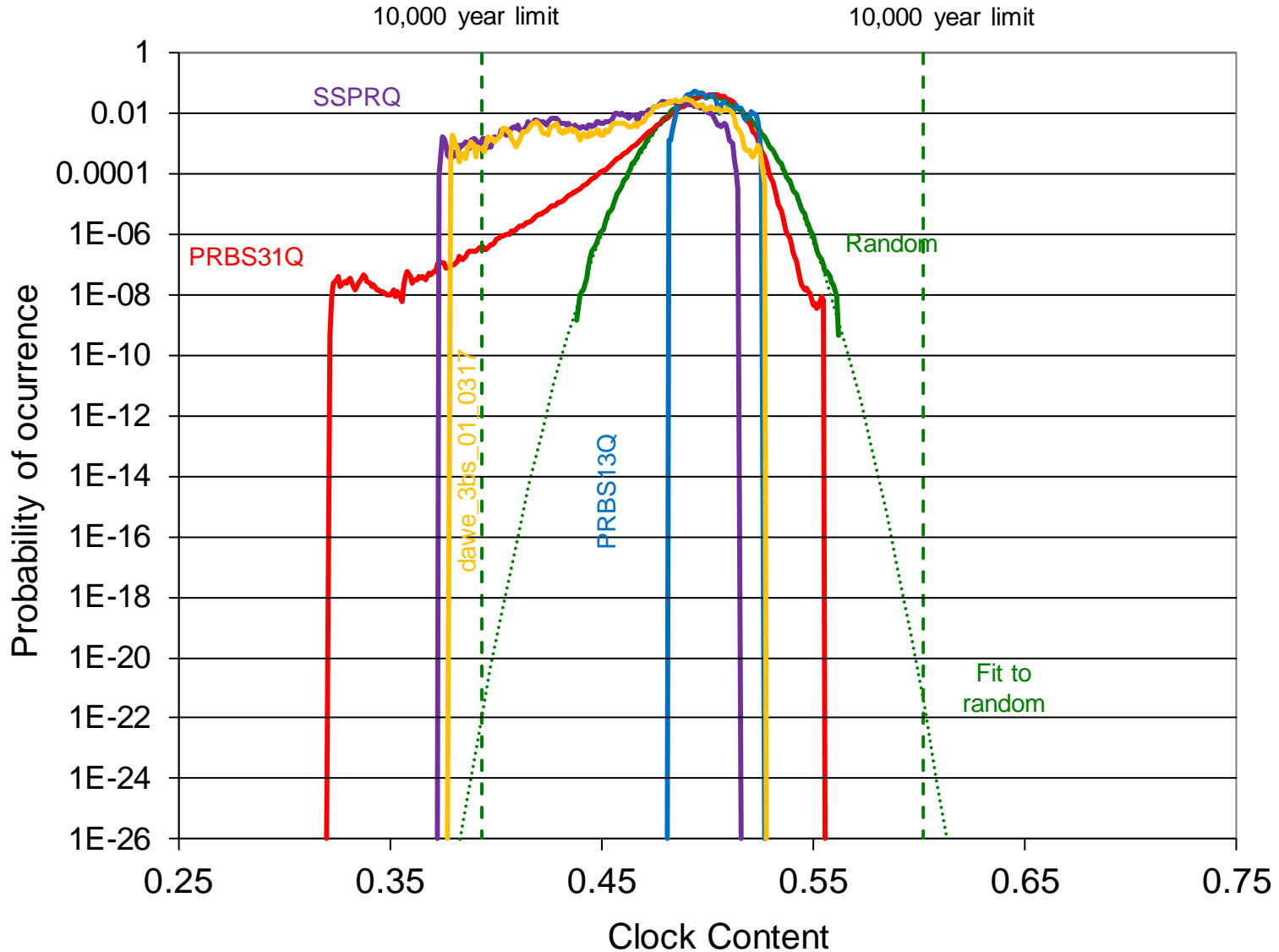

clock, all transitions, 6641

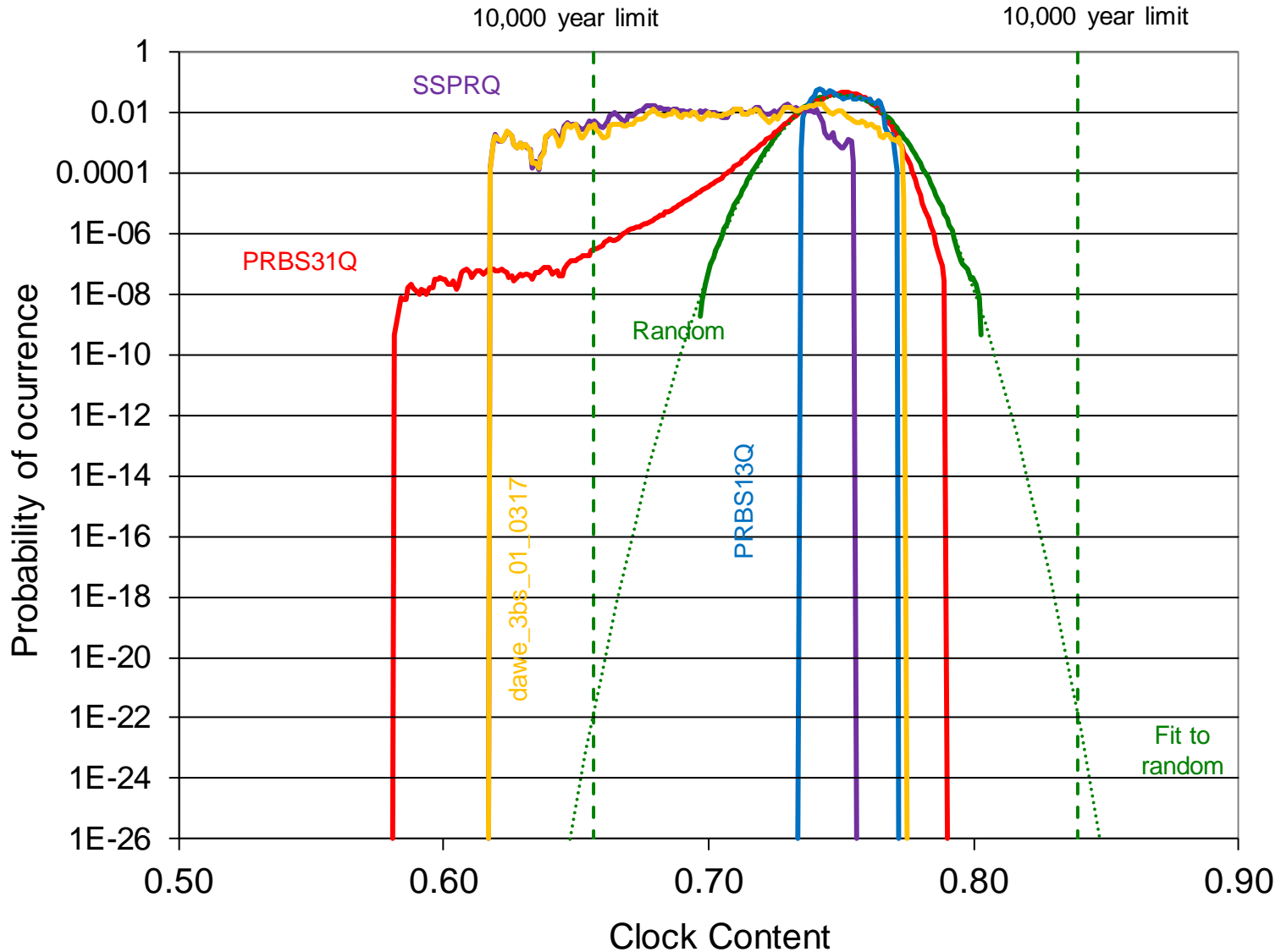

clock, sym trans through ave, 13281

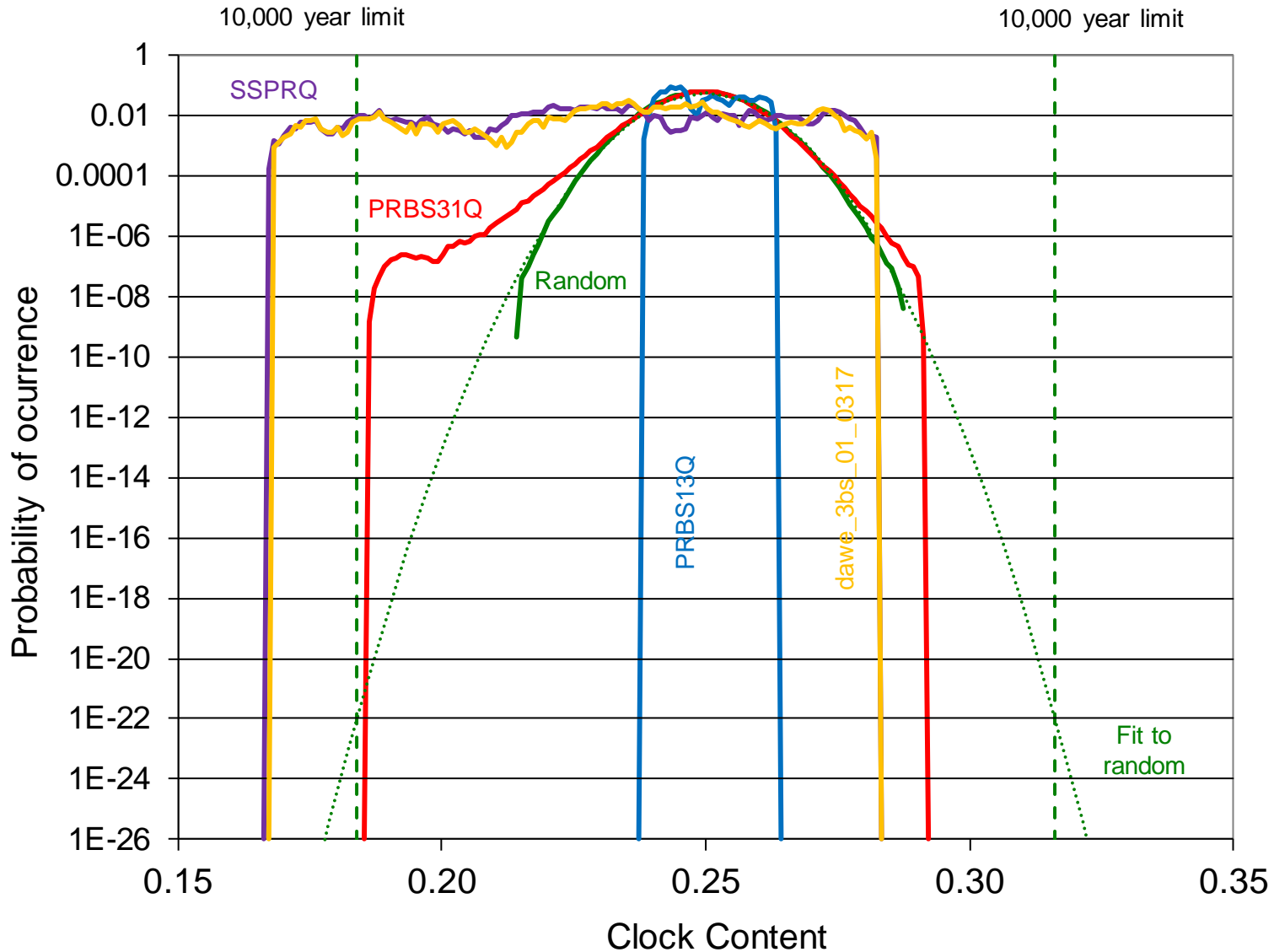

clock, trans through ave, 13281

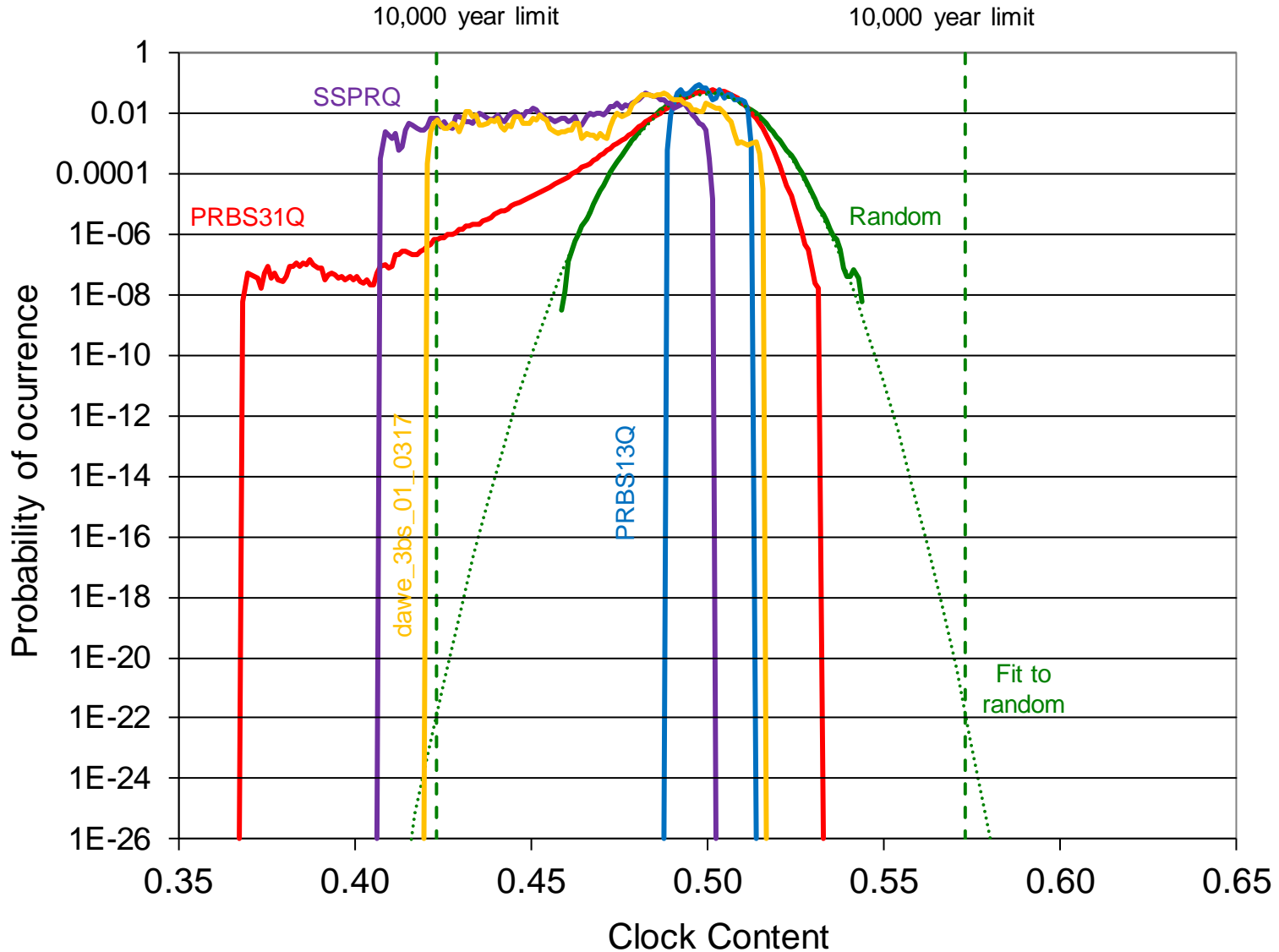

clock, all transitions, 13281

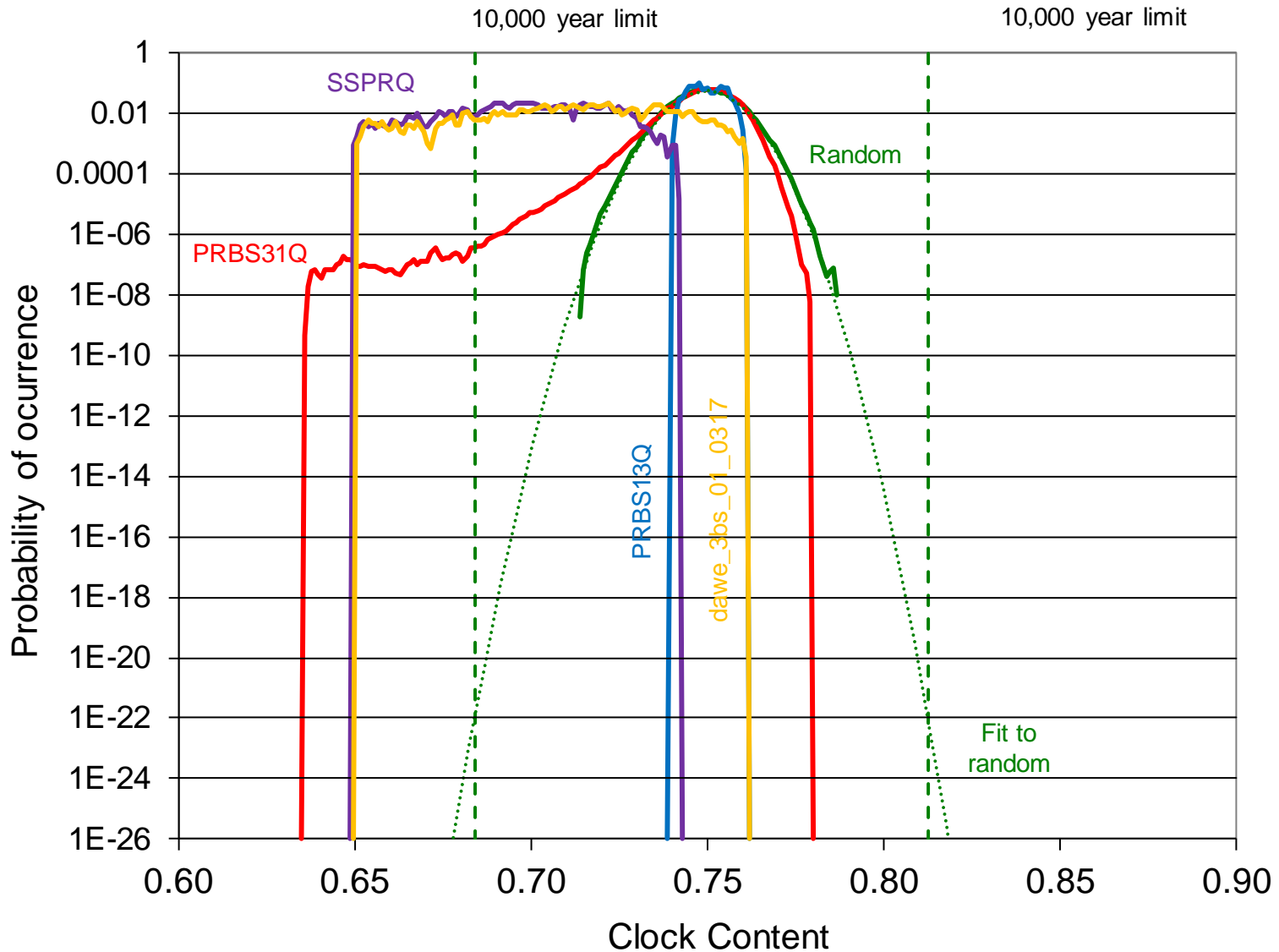

Thanks!