

# Timing diagrams

Miklos Lukacs (Silicon Labs) | 20 May 2016

# Autoclass timing

comment #63

- Into section 33.2.5.11 PSE Type 3 and Type 4 functions: do\_autoclassification
  - Type 3 or Type 4 PSE and PD autoclass example

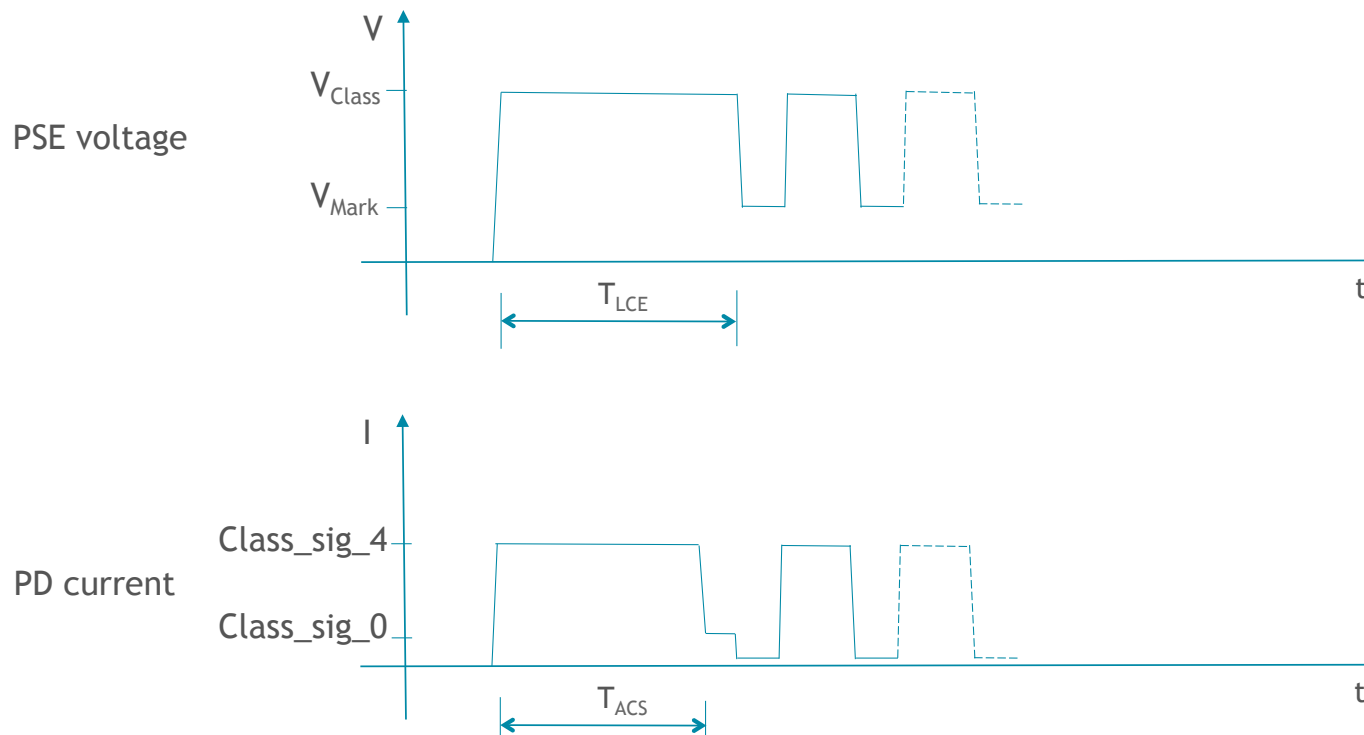

# Connection Check sequence diagrams

comment #64

- After CC\_DET\_SEQ constant description in section 33.2.5.8
- CC\_DET\_SEQ = 0

Single PD load

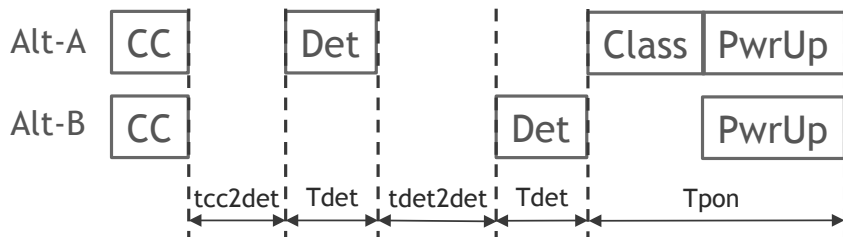

Dual PD load  
Type 3/4

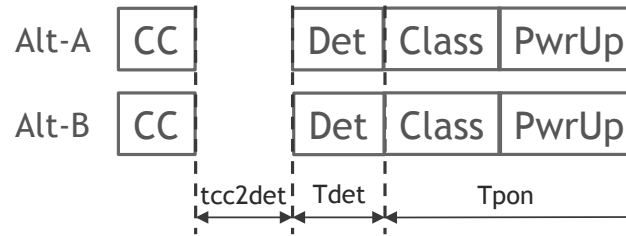

Type 1/2

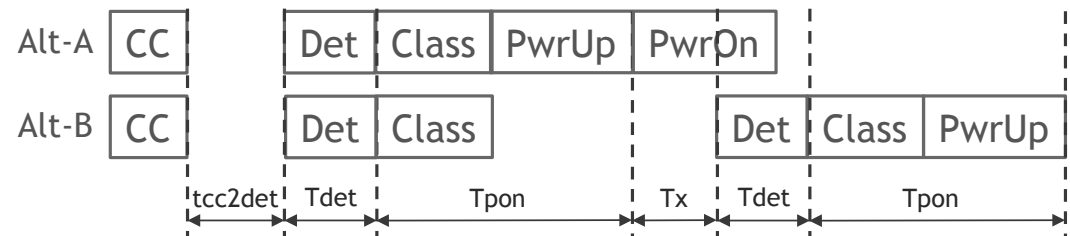

- The Alternatives are interchangeable
- Tx is application dependent

# Connection Check sequence diagrams

comment #64

- CC\_DET\_SEQ = 1

Single PD load

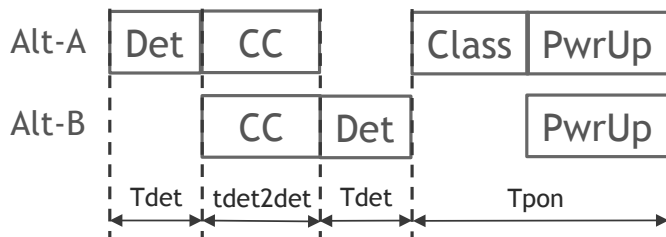

Dual PD load  
Type 3/4

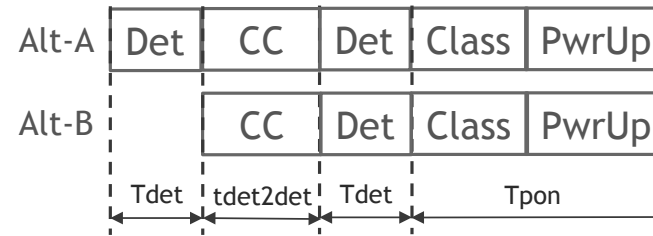

Type 1/2

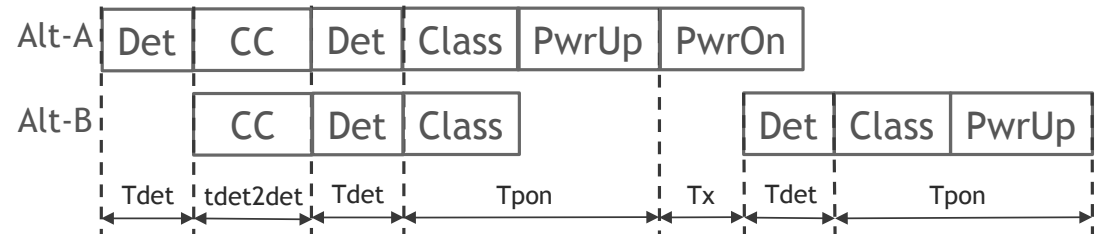

- The Alternatives are interchangeable
- Tx is application dependent

# Connection Check sequence diagrams

comment #64

- CC\_DET\_SEQ = 2

Single PD load

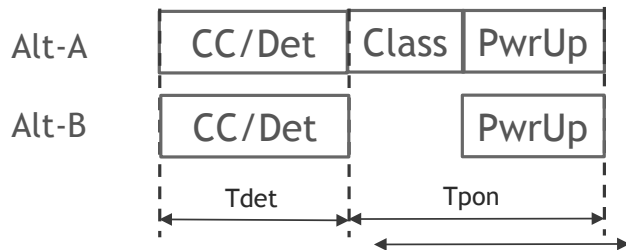

Dual PD load

Type 3/4

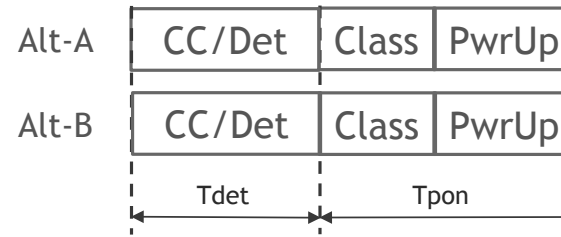

Type 1/2

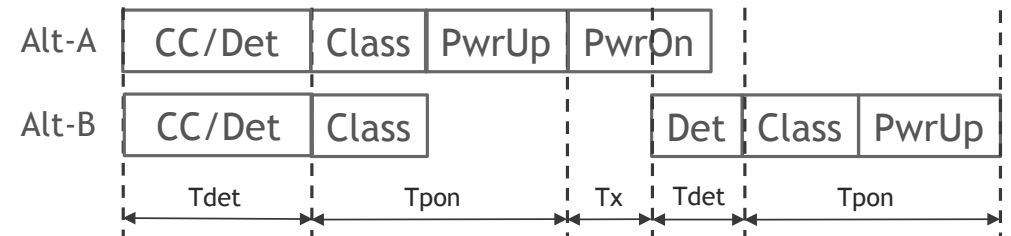

- The Alternatives are interchangeable
- Tx is application dependent

# Connection Check sequence diagrams

comment #64

- CC\_DET\_SEQ = 3

Single PD load

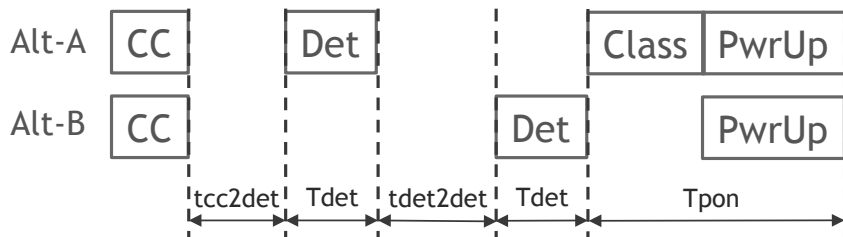

Dual PD load

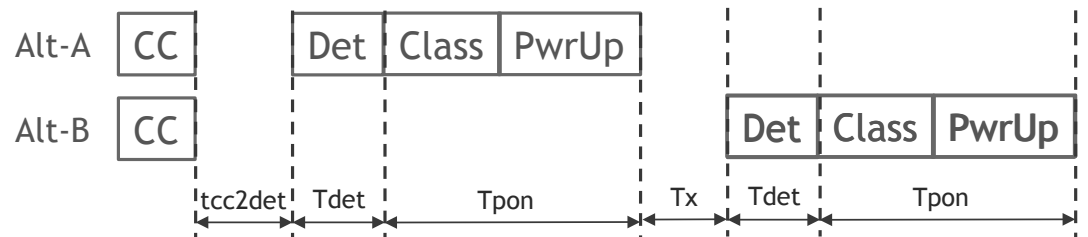

- The Alternatives are interchangeable
- Tx is application dependent

# Single-Event classification

comment #59

- Into section 33.2.7.1 PSE 1-Event Physical Layer classification

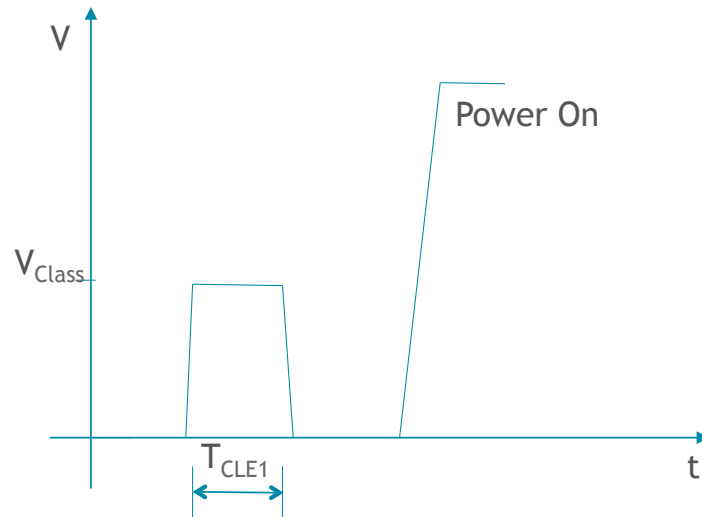

# Multiple-Event Physical Layer classification

comment #60

- Into section 33.2.7.2 PSE Multiple Event Physical Layer classification
  - Diagram 1: Type 2 PSE - Class 4 PD

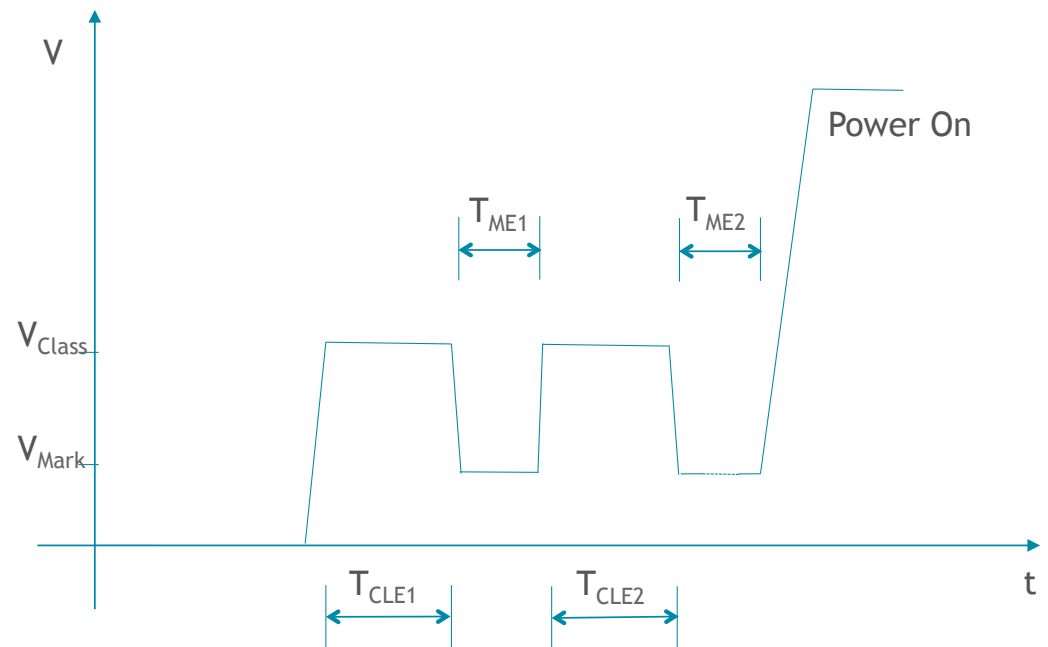



# Multiple-Event Physical Layer classification

comment #60

- Into section 33.2.7.2 PSE Multiple Event Physical Layer classification
- Diagram 2: Type 4 PSE - Class 8 PD - no autotest

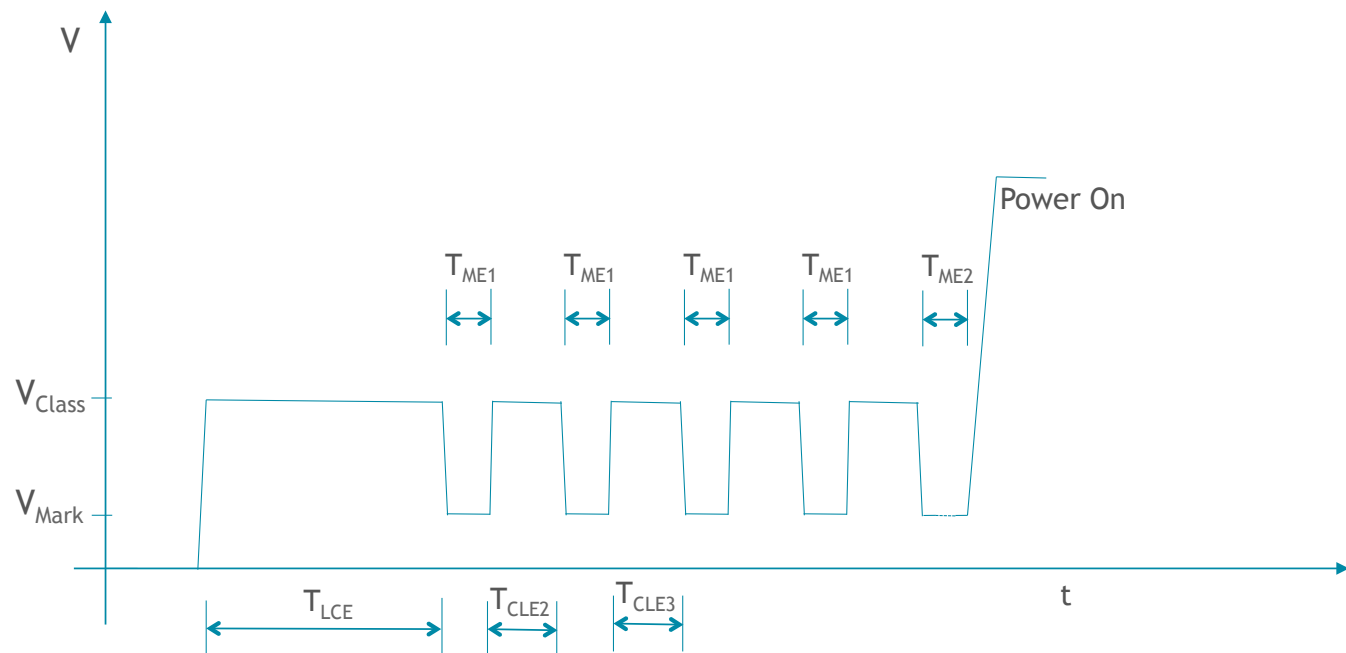

**Thank You!**