

# **Agenda and General Information**

**IEEE P802.3ca 100G-EPON**

Curtis Knittle  
CableLabs  
Chicago, IL  
March 5-7, 2018

# Agenda

NG-EPON

- Appoint Recording Secretary
- Welcome and Introductions
- Decorum
- Approve Agenda
- Approve Minutes
- Reflector and Web
- Ground Rules
- IEEE
  - Structure, Bylaws and Rules
  - Call for Patents
  - IEEE Standards Process
- Liaisons and Communications
- Goals for this meeting
- Presentations
- Motions and Closing Business
- Future Meetings

# P802.3ca Task Force Organization

- ❑ Chair: Curtis Knittle, CableLabs
- ❑ Vice Chair: Glen Kramer, Broadcom
- ❑ Chief Editor: Marek Hajduczenia, Charter

# Task Force Decorum

NGUEPON



- An officer is permitted to make an audio or slideshow recording of this meeting exclusively for the purpose of generating minutes which shall not be copied or distributed. **IEEE 802.3 meetings do not use this option.** Recording of the proceedings by any other participant or observer, in part or in whole, via any means, is prohibited. (December 2017 IEEE-SA Standards Board Ops Manual 5.3.3.2)
- Press (i.e., anyone reporting publicly on this meeting) are to announce their presence (December 2017 IEEE-SA Standards Board Ops Manual 5.3.3.3)
- Cell phone ringers off
- Wear your badges at all times in meeting areas
  - Help the hotel security staff improve the general security of the meeting rooms
  - **PCs HAVE BEEN STOLEN** at previous meetings
  - **DO NOT** assume that meeting areas are secure
- Please observe proper decorum in meetings

# Motion #1

Approve the agenda for 802.3ca March 2018 Task Force meeting as shown in file agenda\_3ca\_1a\_0318.pdf.

Moved: Marek Hajduczenia

Seconded: Alan Brown

Procedural (> 50%)

For: 20

Against: 1

Abstain: 1

Motion: Passes

# Motion #2

NGUEPON

Approve the Minutes of 802.3ca Task Force meeting held January 2018, in Geneva, CH as shown in minutes\_unapproved\_3ca\_0118.pdf and post the approved minutes as minutes\_approved\_3ca\_0118.pdf

Moved: Duane Remein

Seconded: Glen Kramer

Procedural (> 50%)

Motion: passes by voice vote without opposition

# Reflector and Web

NG-EPON

- ❑ To subscribe to the 100G-EPON Task Force reflector, send an email to:

**ListServ@ieee.org**

with the following in the body of the message (do not include "<>"):

**subscribe STDS-802-3-NGEPON** <yourfirstname> <yourlastname>  
**end**

- ❑ Send 100G-EPON reflector messages to:

**STDS-802-3-NGEPON@listserv.ieee.org**

- ❑ Task Force web page URL:

**<http://www.ieee802.org/3/ca/index.shtml>**

# Task Force Private Area



- ❑ Access from 802.3ca home page:  
<http://www.ieee802.org/3/ca/index.shtml>
  
- ❑ Draft 0.7:
  - [http://www.ieee802.org/3/ca/private/drafts/draft\\_ver.shtml?D0\\_7](http://www.ieee802.org/3/ca/private/drafts/draft_ver.shtml?D0_7)
  
  - Username:
  - Password:
  
- ❑ Write it down...
  
- ❑ Note - The draft, and any other content, is posted for your review only, and neither the content nor access information should be copied or redistributed to others in violation of document copyrights.



# Ground Rules

NG-EPON

- ❑ Based upon IEEE 802.3 Rules
  - Foundation based upon Robert's Rules of Order
  - Anyone in the room may speak
  - Anyone in the room may vote
- ❑ **RESPECT**... give it, get it
- ❑ NO product pitches
- ❑ NO corporate pitches
- ❑ NO prices!!!
  - This includes costs, ASPs, etc. no matter what the currency
- ❑ NO restrictive notices

- Tutorial Material on attendance tool
  - [http://ieee802.org/3/minutes/attendance\\_procedures.pdf](http://ieee802.org/3/minutes/attendance_procedures.pdf)
  
- Access details
  - URL: <http://imat.ieee.org/>
  - (For interim) Password will be provided

# IEEE Structure

NG-EPON

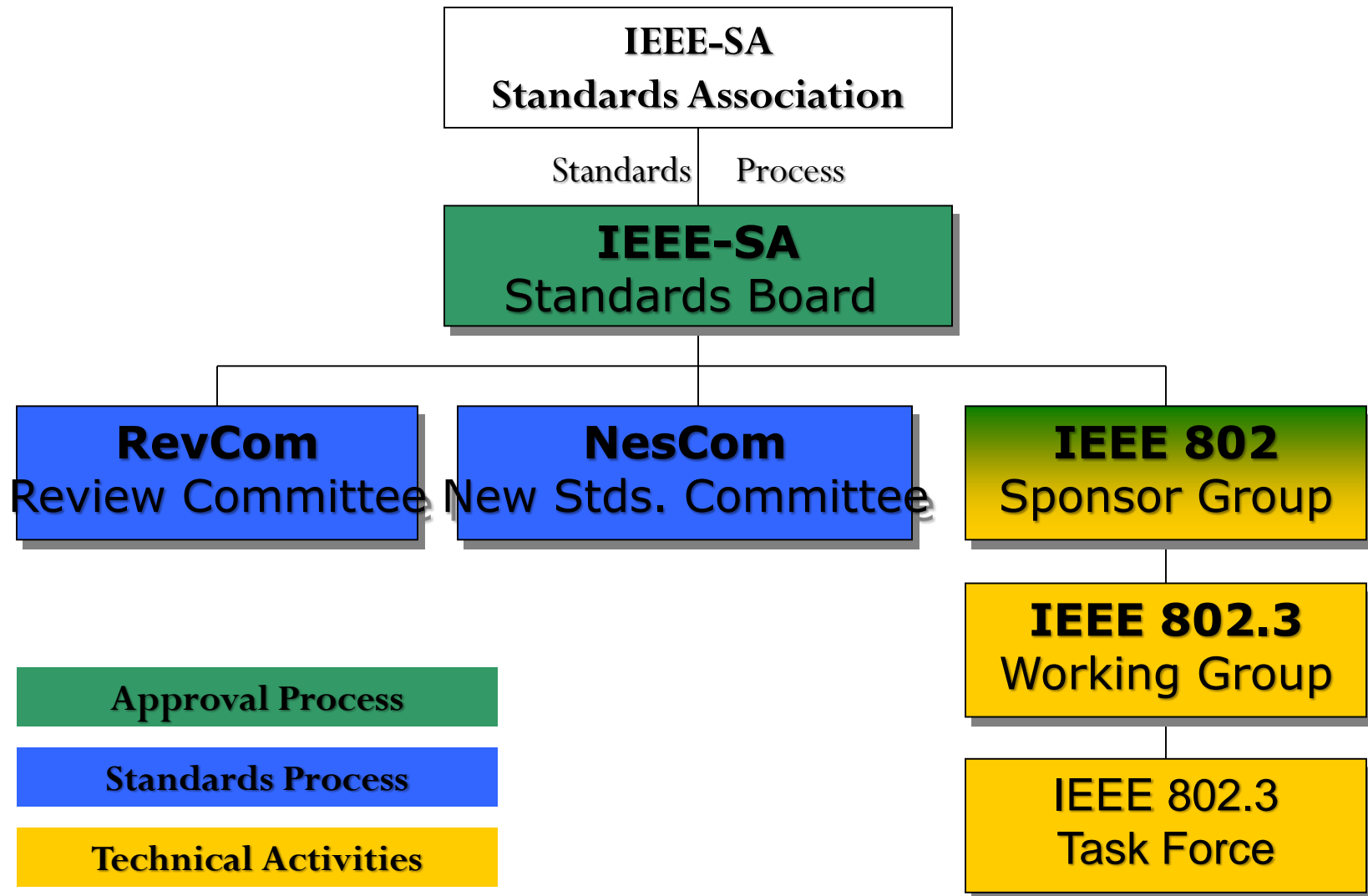

# Important Bylaws and Rules

- ❑ **IEEE-SA Operations Manual**  
[http://standards.ieee.org/develop/policies/sa\\_opman/](http://standards.ieee.org/develop/policies/sa_opman/)
- ❑ **IEEE-SA Standards Board Bylaws**  
<http://standards.ieee.org/develop/policies/bylaws/>
- ❑ **IEEE-SA Standards Board Operations Manual**  
<http://standards.ieee.org/develop/policies/opman/>
- ❑ **IEEE 802 LAN/MAN Standards Committee (LMSC) Policies and Procedures**  
<http://standards.ieee.org/about/sasb/audcom/np/LMSC.pdf>
- ❑ **IEEE 802 LAN/MAN Standards Committee (LMSC) Operations Manual**  
<http://www.ieee802.org/devdocs.shtml>
- ❑ **IEEE 802 LAN/MAN Standards Committee (LMSC) Working Group (WG) Policies and Procedures**  
<http://www.ieee802.org/devdocs.shtml>
- ❑ **IEEE 802.3 Working Group Operating Rules**  
[http://ieee802.org/3/rules/P802\\_3\\_rules.pdf](http://ieee802.org/3/rules/P802_3_rules.pdf)

# Participants have a duty to inform the IEEE

- Participants shall inform the IEEE (or cause the IEEE to be informed) of the identity of each holder of any potential Essential Patent Claims of which they are personally aware if the claims are owned or controlled by the participant or the entity the participant is from, employed by, or otherwise represents
- Participants should inform the IEEE (or cause the IEEE to be informed) of the identity of any other holders of potential Essential Patent Claims
- Early identification of holders of potential Essential Patent Claims is encouraged

# Ways to inform IEEE

NG-EPON

- ❑ **Cause an LOA to be submitted to the IEEE-SA (patcom@ieee.org); or**
- ❑ **Provide the chair of this group with the identity of the holder(s) of any and all such claims as soon as possible; or**
- ❑ **Speak up now and respond to this Call for Potentially Essential Patents**

If anyone in this meeting is personally aware of the holder of any patent claims that are potentially essential to implementation of the proposed standard(s) under consideration by this group and that are not already the subject of an Accepted Letter of Assurance, please respond at this time by providing relevant information to the WG Chair

# Other guidelines for IEEE WG meetings

- All IEEE-SA standards meetings shall be conducted in compliance with all applicable laws, including antitrust and competition laws.
  - Don't discuss the interpretation, validity, or essentiality of patents/patent claims.
  - Don't discuss specific license rates, terms, or conditions.
    - Relative costs of different technical approaches that include relative costs of patent licensing terms may be discussed in standards development meetings.
      - » Technical considerations remain the primary focus
  - Don't discuss or engage in the fixing of product prices, allocation of customers, or division of sales markets.
  - Don't discuss the status or substance of ongoing or threatened litigation.
  - Don't be silent if inappropriate topics are discussed ... do formally object.

-----  
For more details, see IEEE-SA Standards Board Operations Manual, clause 5.3.10 and Antitrust and Competition Policy: What You Need to Know at <http://standards.ieee.org/develop/policies/antitrust.pdf>

# Patent-related information

The patent policy and the procedures used to execute that policy are documented in the:

- ***IEEE-SA Standards Board Bylaws***  
(<http://standards.ieee.org/develop/policies/bylaws/sect6-7.html#6>)
- ***IEEE-SA Standards Board Operations Manual***  
(<http://standards.ieee.org/develop/policies/opman/sect6.html#6.3>)

Material about the patent policy is available at  
<http://standards.ieee.org/about/sasb/patcom/materials.html>

**If you have questions, contact the IEEE-SA  
Standards Board Patent Committee  
Administrator at [patcom@ieee.org](mailto:patcom@ieee.org)**



# Participation in IEEE 802 Meetings

March 2017

**All participation in IEEE 802 Working Group meetings is on an individual basis**

- **Participants in the IEEE standards development individual process shall act based on their qualifications and experience.**  
([https://standards.ieee.org/develop/policies/bylaws/sb\\_bylaws.pdf](https://standards.ieee.org/develop/policies/bylaws/sb_bylaws.pdf) section 5.2.1)
- **IEEE 802 Working Group membership is by individual; “Working Group members shall participate in the consensus process in a manner consistent with their professional expert opinion as individuals, and not as organizational representatives”. (subclause 4.2.1 “Establishment”, of the IEEE 802 LMSC Working Group Policies and Procedures)**
- **Participants have an obligation to act and vote as an individual and not under the direction of any other individual or group. A Participant’s obligation to act and vote as an individual applies in all cases, regardless of any external commitments, agreements, contracts, or orders.**
- **Participants shall not direct the actions or votes of any other member of an IEEE 802 Working Group or retaliate against any other member for their actions or votes within IEEE 802 Working Group meetings, see [https://standards.ieee.org/develop/policies/bylaws/sb\\_bylaws.pdf](https://standards.ieee.org/develop/policies/bylaws/sb_bylaws.pdf) section 5.2.1.3 and the IEEE 802 LMSC Working Group Policies and Procedures, subclause 3.4.1 “Chair”, list item x.**

**By participating in IEEE 802 meetings, you accept these requirements. If you do not agree to these policies then you shall not participate.**

(Latest revision of IEEE 802 LMSC Working Group Policies and Procedures: <http://www.ieee802.org/devdocs.shtml>)

# Role of the Chair

- ❑ Per the IEEE 802.3 Ethernet WG Operations Manual ([http://www.ieee802.org/3/rules/P802\\_3\\_rules.pdf](http://www.ieee802.org/3/rules/P802_3_rules.pdf))
  - The operation of the TF has to be balanced between democratic procedures that reflect the desires of the TF members and the TF Chair's responsibility to produce a draft standard, recommended practice, or guideline in a reasonable amount of time for review and approval by the WG. Robert's Rules of Order shall be used in combination with these operating rules to achieve this balance.
  - The full responsibilities of the chair are specified in 3.4.3 Task Force Chair's Responsibilities.
- ❑ Reminder - individual standards activities within the WG are, at the discretion of the WG, carried out by Task Forces (TF) operating under, and reporting to, the WG.

# Overview of IEEE 802.3 Standards Process (1/5)- Study Group Phase

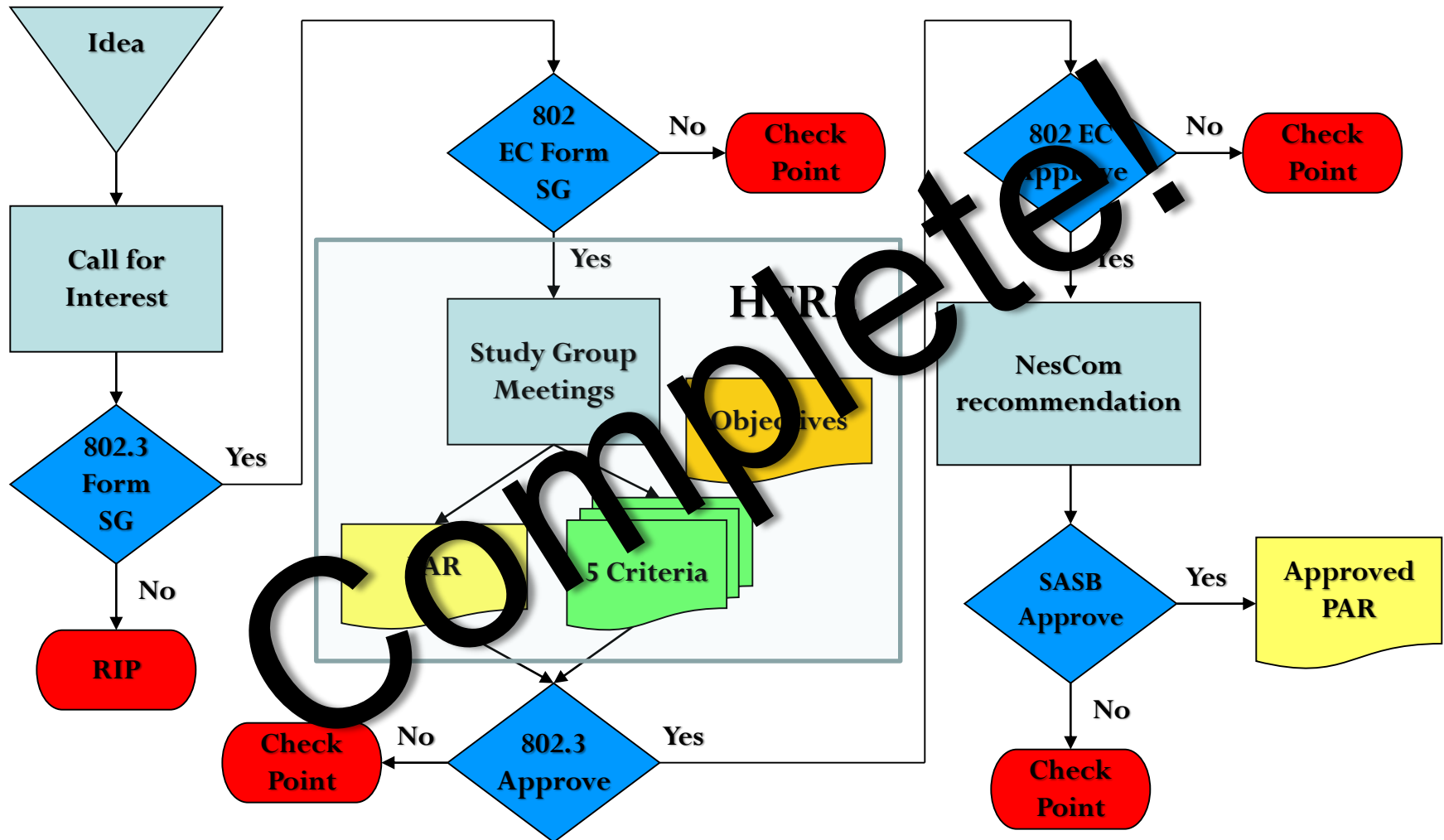

Note: At "Check Point", either the activity is ended, or there may be various options that would allow reconsideration of the approval.

# Overview of IEEE 802.3 Standards Process (2/5) – Task Force Comment Phase

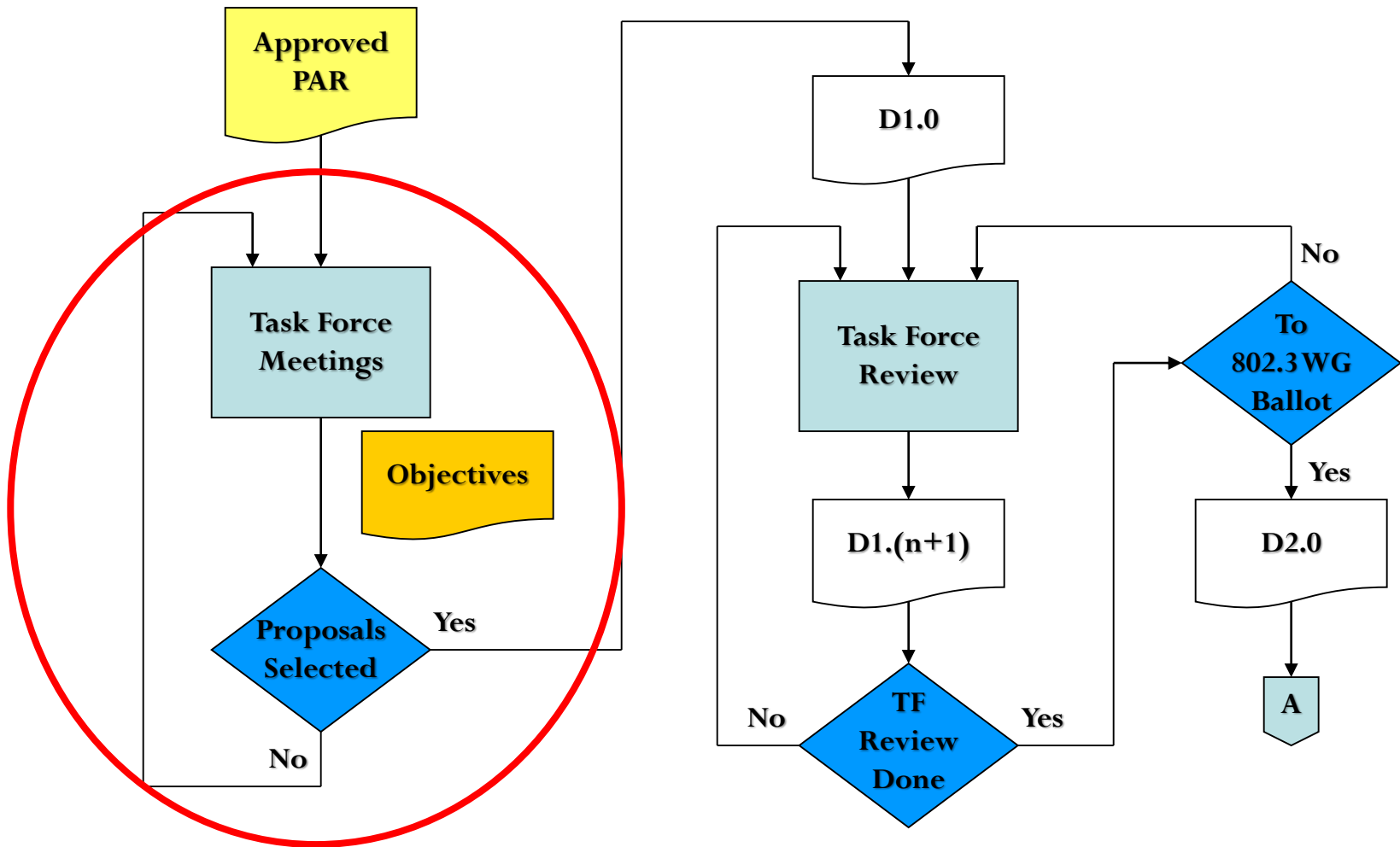

# Overview of IEEE 802.3 Standards Process (3/5) – Working Group Ballot Phase

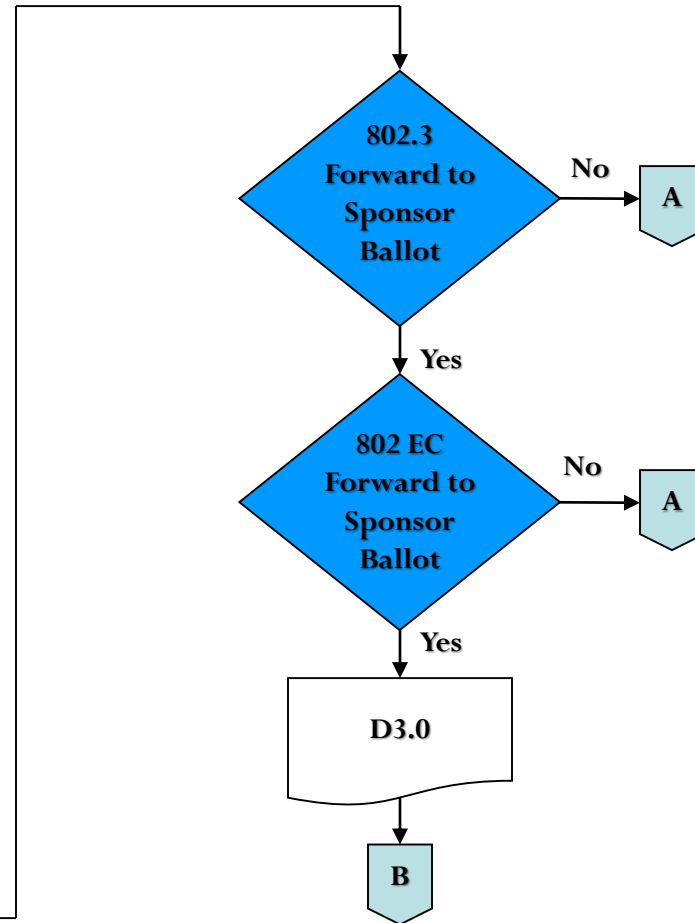
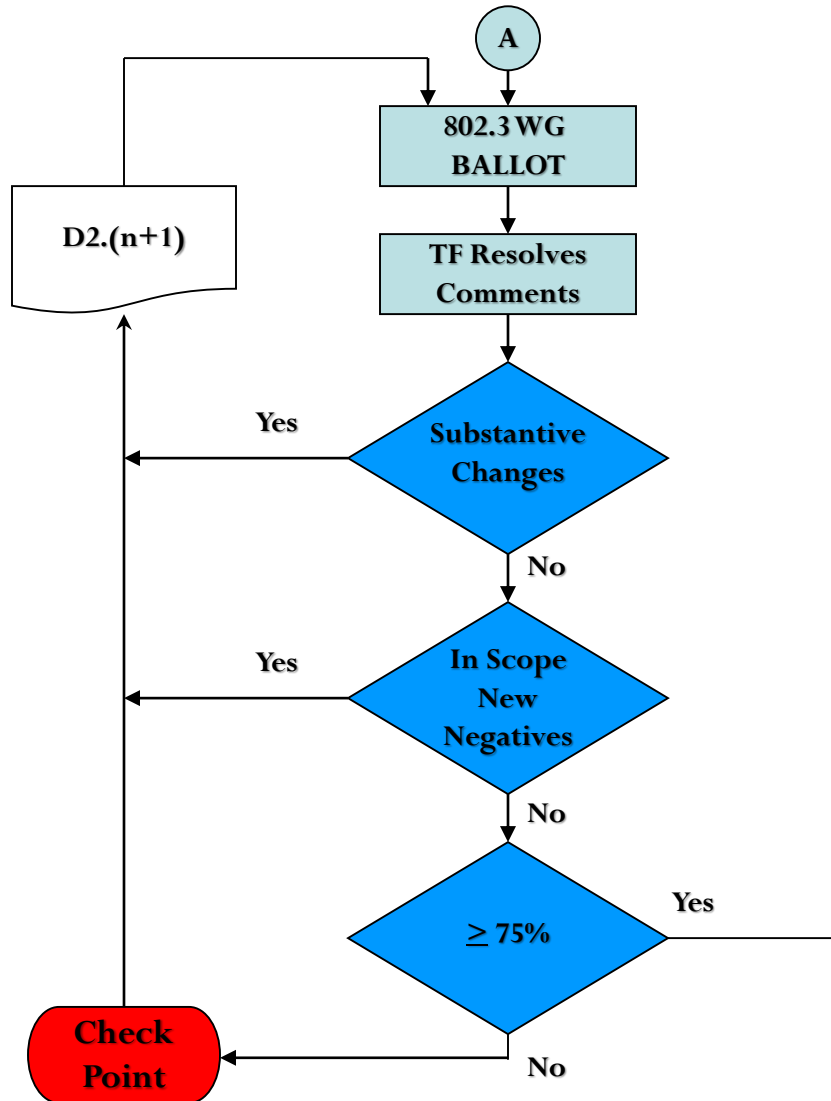

**Notes:** At "Check Point", either the activity is ended, or there may be various options that would allow reconsideration of the approval.

See 802.3 Operating Rules 7.1.4 and listed references for complete description

# Overview of IEEE 802.3 Standards Process (4/5)- Sponsor Ballot Phase

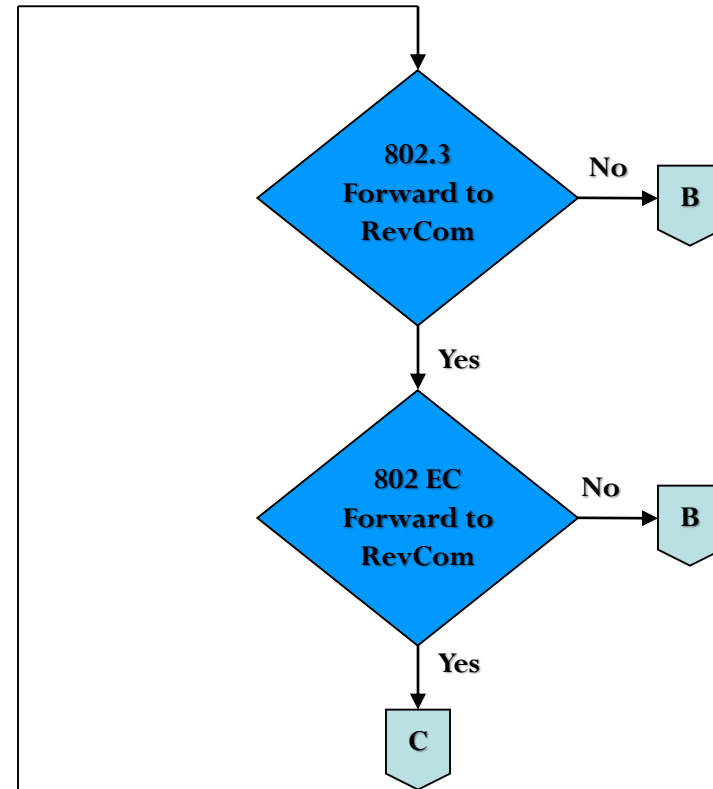
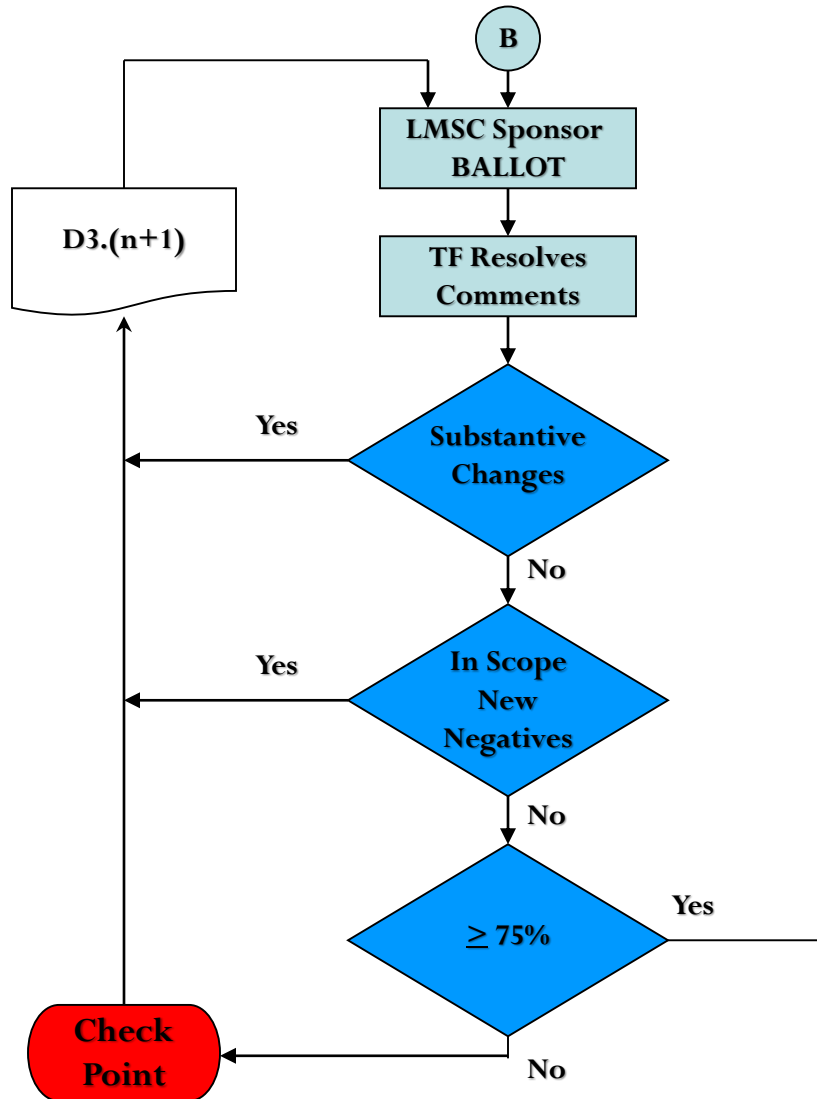

**Notes:** At "Check Point", either the activity is ended, or there may be various options that would allow reconsideration of the approval.

See 802.3 Operating Rules 7.1.5 and listed references for complete description

# Overview of IEEE 802.3 Standards Process (5/5) – Final Approvals / Standard Release

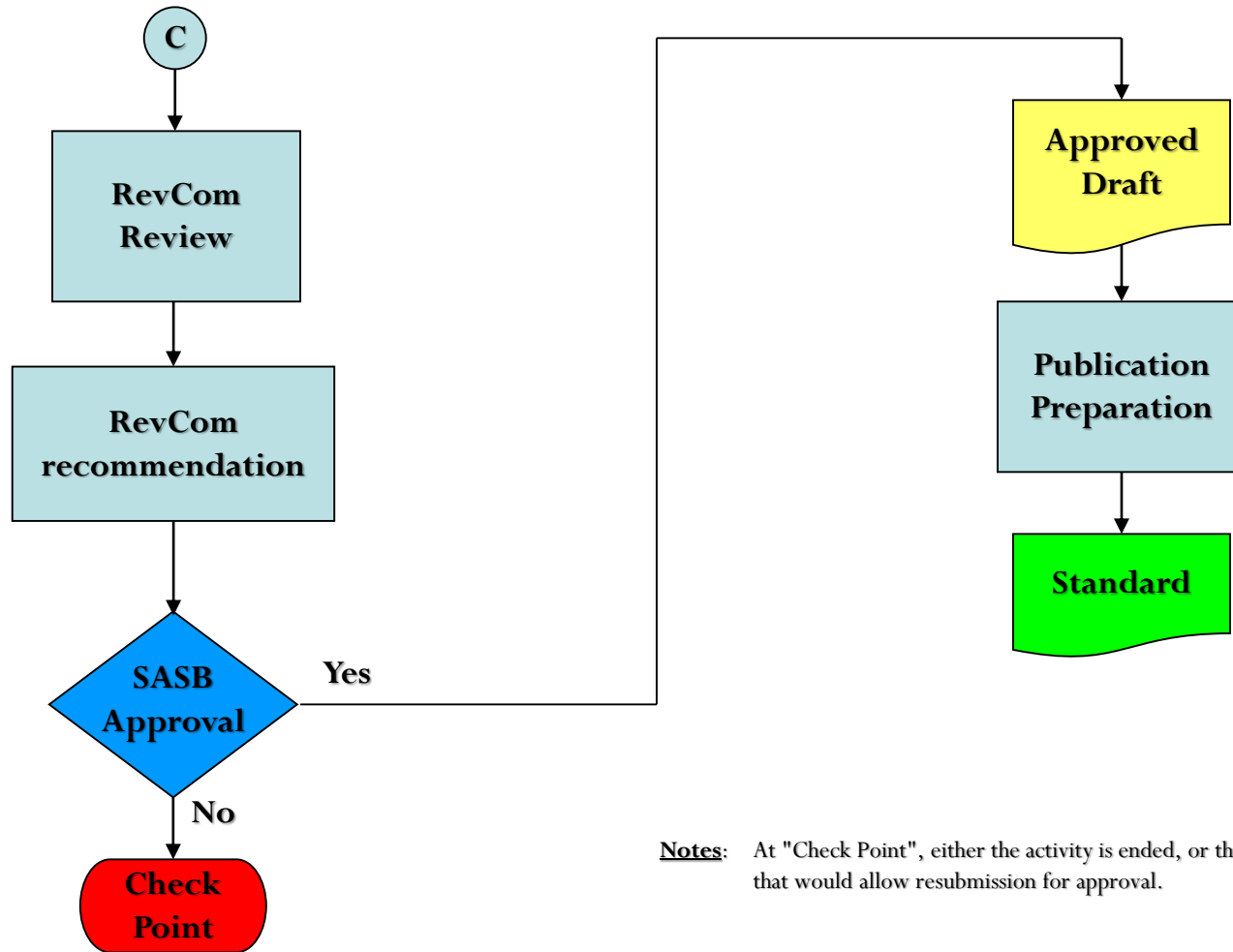

**Notes:** At "Check Point", either the activity is ended, or there may be various options that would allow resubmission for approval.

# Liaisons and Communications

From: ITU-T Study Group 15

Title: LS - High Speed PON Liaison to IEEE  
P802.3ca

[http://www.ieee802.org/3/minutes/mar18/incoming/ITU\\_SG15-LS-95\\_to\\_IEEE\\_802d3.pdf](http://www.ieee802.org/3/minutes/mar18/incoming/ITU_SG15-LS-95_to_IEEE_802d3.pdf)



# Goals for this Meeting

NG-EPON

- ❑ Hear technical contributions
- ❑ Adopt baseline proposals for wavelength plan, MPCP, FEC, ...
- ❑ Identify steps moving forward

# IEEE P802.3ca 100G-EPON Approved Project Documents

## □ PAR

- [http://www.ieee802.org/3/ca/documents/P802\\_3ca\\_par\\_approved.pdf](http://www.ieee802.org/3/ca/documents/P802_3ca_par_approved.pdf)

## □ CSD

- <https://mentor.ieee.org/802-ec/dcn/15/ec-15-0100-00-ACSD-802-3ca.pdf>

## □ Objectives

- [http://www.ieee802.org/3/ca/documents/P802\\_3ca\\_objectives.pdf](http://www.ieee802.org/3/ca/documents/P802_3ca_objectives.pdf)

# IEEE P802.3ca 100G-EPON Objectives

- ❑ Support subscriber access networks using point-to-multipoint topologies on optical fiber
- ❑ Provide Physical Layer specifications that
  - Operate over a single SMF strand
  - Support symmetric and/or asymmetric MAC data rates of:
    - 25 Gb/s in downstream and less than or equal to 25 Gb/s in upstream (25G-EPON)
    - 50 Gb/s in downstream and less than or equal to 50 Gb/s in upstream (50G-EPON)
    - ~~100 Gb/s in downstream and less than or equal to 100 Gb/s in upstream (100G-EPON)~~
  - Have a BER better than or equal to  $10^{-12}$  at the MAC/PLS service interface (or the frame loss ratio equivalent)
  - Support coexistence with **select legacy PON technologies**
    - Optical power budgets to accommodate channel insertion losses equivalent to **PR20 and PR30, as defined in Clause 75.**
    - Wavelength allocation allowing concurrent operation with 10G-EPON, XG-PON1, and XGS-PON PHYs (**1575nm-1580nm downstream, 1260nm-1280nm upstream**)
    - Wavelength allocation allowing concurrent operation of 25G-EPON and G-PON reduced wavelength set (**1480nm-1500nm downstream, 1290nm-1330nm upstream**) PHYs

# IEEE P802.3ca 100G-EPON Timeline

## IEEE P802.3ca Timeline

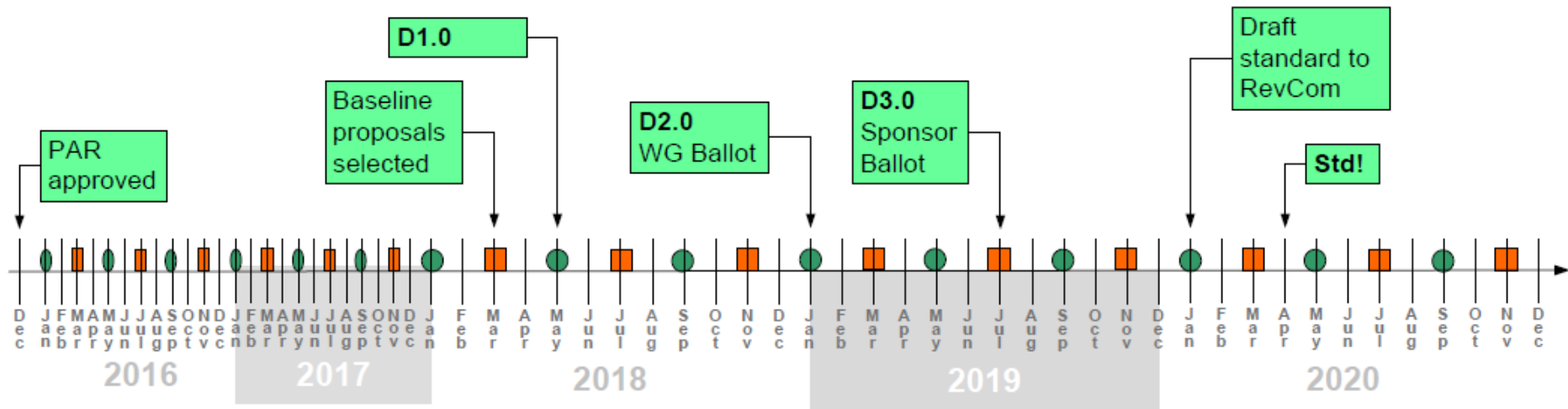

- - 802.3 Interim Meeting
- - 802.3 Plenary Meeting

# Future Meetings

NG-EPON

- ❑ See: <http://www.ieee802.org/3/interims/index.html>
  
- ❑ May 2018 Interim
  - Pittsburgh, PA
  - Week of May 21, 2018
  
- ❑ July 2018 Plenary
  - San Diego, CA
  - Week of July 9, 2018
  
- ❑ Anyone interested in hosting a interim meeting contact me or the IEEE 802.3 Executive Secretary [Steve Carlson](#).

# Attendance at Future Meetings

Attend May 2018 interim in Pittsburgh, PA, USA :  
Y: 20 N: 2 M: 2

Attend July 2018 802 Plenary in San Diego, CA,  
USA:  
Y: 21 N: 1 M: 4

Total in the room: 25

- *We have a draft standard (v0.7)....*

IEEE P802.3ca™/D0.6, 14 November 2017  
(Amendment of IEEE Std 802.3™-2015)

**IEEE P802.3ca™/D0.6**

**Draft Standard for Ethernet**

**Amendment:**

**Physical Layer Specifications and  
Management Parameters for 25 Gb/s,  
50 Gb/s, and 100 Gb/s Passive Optical  
Networks**

1  
2  
3  
4  
5  
6  
7  
8  
9  
10  
11  
12  
13  
14  
15  
16  
17  
18  
19  
20  
21

# State of 802.3ca

- ❑ *The architecture approved by the task force, and written into the draft, is 1, 2, and 4 lanes of 25 Gbps*

Draft Amendment to IEEE Std 802.3-2015  
IEEE P802.3ca 100G-EPON PHY Task Force

IEEE Draft P802.3ca/D0.5  
14 September 2017

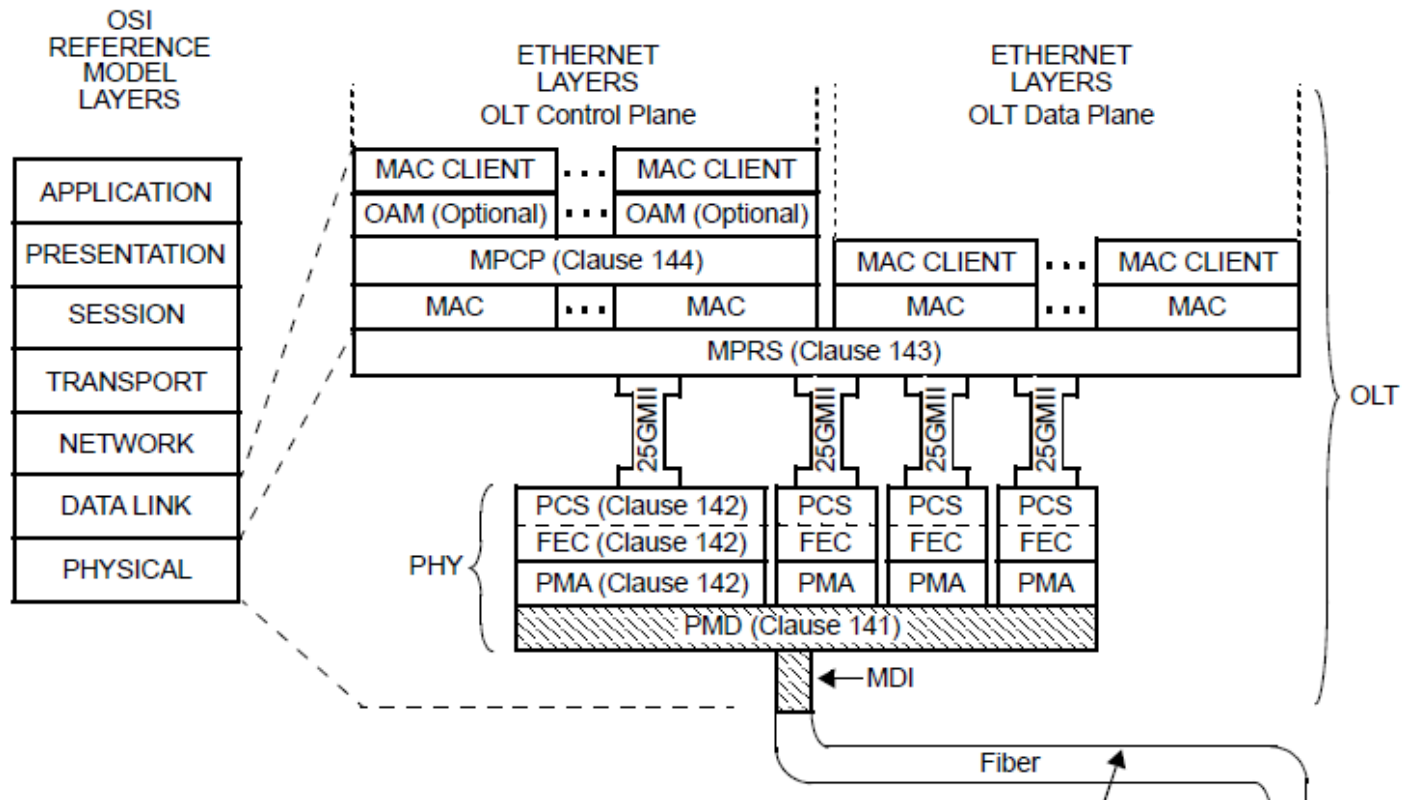



**Thank you!**