

---

# Baseline proposals for copper twinaxial cable specifications

Chris DiMinico  
MC Communications/PHY-SI LLC/Panduit  
[cdiminico@ieee.org](mailto:cdiminico@ieee.org)

# Purpose

---

- Baseline proposals for 802.3cd copper twinaxial cable specifications consistent with adopted objectives
  - Tx/Rx receiver PCB insertion loss specifications
  - Test fixtures PCB insertion loss specifications
  - Host channel insertion loss specifications
  - Channel insertion loss specifications
  - Cable assembly specifications
  - Test fixture specifications
  - MDI specifications

# Supporters

---

- **Scott Sommers, Chris Roth, Tom Palkert – Molex**
- **Rich Mellitz – Intel**
- **Jon Lewis – Dell**
- **Ron Nordin, Brett Lane – Panduit**
- **Nathan Tracy – TE Connectivity**
- **Erdem Matoglu, Andrew Zambell – Amphenol**
- **Ali Ghiasi – Ghiasi Quantum LLC**
- **Mike Dudek – QLogic Corporation**

# 802.3cd Objectives

## Objectives 1 of 2

- Support full-duplex operation only
- Preserve the Ethernet frame format utilizing the Ethernet MAC
- Preserve minimum and maximum FrameSize of current IEEE 802.3 standard
- Support optional Energy-Efficient Ethernet operation
- Provide appropriate support for OTN
- Support a MAC data rate of 50 Gb/s and 100 Gb/s
- Support a BER of better than or equal to  $10^{-12}$  at the MAC/PLS service interface (or the frame loss ratio equivalent) for 50 Gb/s and 100 Gb/s operation
- Support a MAC data rate of 200 Gb/s
- Support a BER of better than or equal to  $10^{-13}$  at the MAC/PLS service interface (or the frame loss ratio equivalent) for 200 Gb/s operation

Source: [http://www.ieee802.org/3/cd/P802d3cd\\_objectives\\_v2.pdf](http://www.ieee802.org/3/cd/P802d3cd_objectives_v2.pdf)

# 802.3cd Objectives

## Objectives 2 of 2

### 50 Gb/s Ethernet PHYs

- Define single-lane 50 Gb/s PHYs for operation over
  - copper twin-axial cables with lengths up to at least 3m.
  - printed circuit board backplane with a total channel insertion loss of  $\leq 30$ dB at 13.28125 GHz.
  - MMF with lengths up to at least 100m
  - SMF with lengths up to at least 2km
  - SMF with lengths up to at least 10km

### 100 Gb/s Ethernet PHYs

- Define a two-lane 100 Gb/s PHY for operation over
  - copper twin-axial cables with lengths up to at least 3m.
  - printed circuit board backplane with a total channel insertion loss of  $\leq 30$ dB at 13.28125 GHz.
  - MMF with lengths up to at least 100m
  - SMF with lengths up to at least 500m
- Define a 100 Gb/s PHY for operation over SMF with lengths up to at least 2 km

### 200 Gb/s Ethernet PHYs

- Define four-lane 200 Gb/s PHYs for operation over
  - copper twin-axial cables with lengths up to at least 3m.
  - printed circuit board backplane with a total channel insertion loss of  $\leq 30$ dB at 13.28125 GHz.
- Define 200 Gb/s PHYs for operation over MMF with lengths up to at least 100m

Source: [http://www.ieee802.org/3/cd/P802d3cd\\_objectives\\_v2.pdf](http://www.ieee802.org/3/cd/P802d3cd_objectives_v2.pdf)

# Tx/Rx receiver PCB IL - Baseline

- Use transmitter and receiver differential printed circuit board trace loss min and max (with IL @ 13.28GHz)
  - Specified in 92A.4 EQ(92A-1 (max) and 92A-2 (min))—referenced 110A.4

# Transmitter and receiver differential PCB IL

- IL @ 13.28 GHz

$$IL_{PCB}(f) \leq IL_{PCBmax}(f) = 0.5(0.0694 + 0.4248\sqrt{f} + 0.9322f) \quad (\text{dB})$$

for  $0.01 \text{ GHz} \leq f \leq 19 \text{ GHz}$ .

IL @ 12.89 GHz = 6.81 dB

where

IL @ 13.28 GHz = 7.00 dB

- $f$  is the frequency in GHz
- $IL_{PCB}(f)$  is the insertion loss for the transmitter and receiver PCB
- $IL_{PCBmax}(f)$  is the recommended maximum insertion loss for the transmitter and receiver PCB

$$IL_{PCB}(f) \geq IL_{PCBmin}(f) = 0.086(0.0694 + 0.4248\sqrt{f} + 0.9322f) \quad (\text{dB})$$

for  $0.01 \text{ GHz} \leq f \leq 19 \text{ GHz}$ .

IL @ 12.89 GHz = 1.17 dB

where

IL @ 13.28 GHz = 1.20 dB

- $f$  is the frequency in GHz
- $IL_{PCB}(f)$  is the insertion loss for the transmitter and receiver PCB
- $IL_{PCBmin}(f)$  is the minimum insertion loss for the transmitter and receiver PCB

IL @ 12.89 GHz = Max 6.81 dB  
= Min 1.17 dB

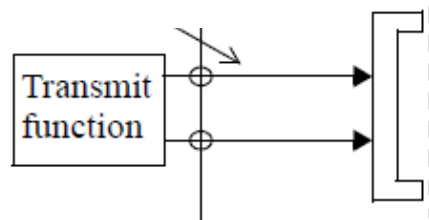

IL @ 13.28 GHz = Max 7.00 dB  
= Min 1.20 dB

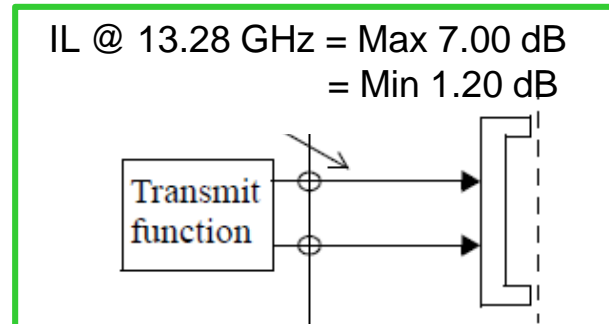

# Test Fixture PCB IL - Baseline

- Use TP2 or TP3 (HCB) test fixture printed circuit board reference insertion loss with IL @ 13.28 GHz specified in
  - 802.3bj 92.11.1.2 Test fixture insertion loss equation (92-34)
    - Referenced in 802.3by 110B.1.1 SFP28 TP2 or TP3 test fixture
- Use Cable assembly (MCB) test fixture printed circuit board reference insertion loss with IL @ 13.28 GHz specified in
  - 802.3bj 92.11.1.2 Test fixture insertion loss equation (92-34)
    - Referenced in 802.3by 110B.1.1 SFP28 TP2 or TP3 test fixture

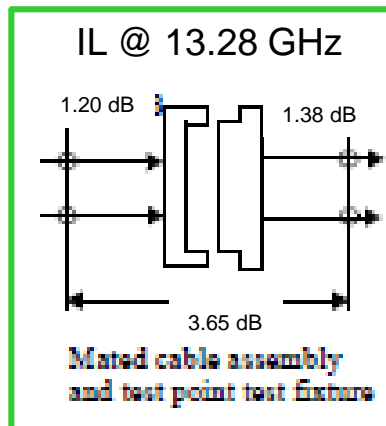
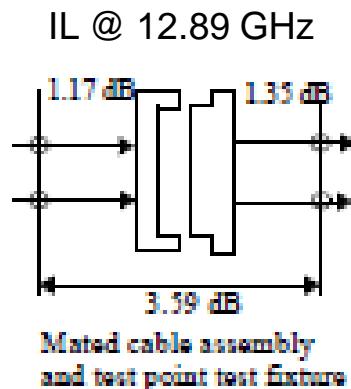



# Test fixtures PCB IL

$$IL_{tref}(f) = -0.00144 + 0.13824\sqrt{f} + 0.06624 f \quad (\text{dB})$$

for  $0.01 \leq f \leq 25$  GHz

IL @ 12.89 GHz = 1.35 dB

where

IL @ 13.28 GHz = 1.38 dB

$f$  is the frequency in GHz

$IL_{tref}(f)$  is the reference test fixture PCB insertion loss at frequency  $f$

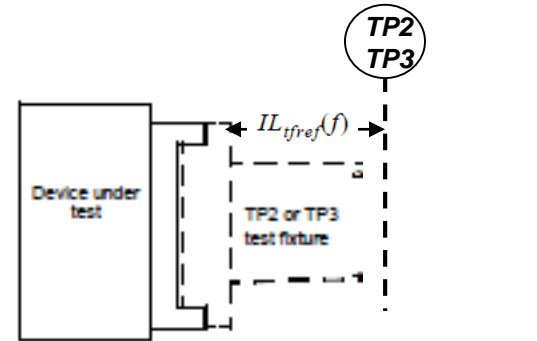

$$IL_{catf}(f) = -0.00125 + 0.12\sqrt{f} + 0.0575f \quad (\text{dB})$$

for  $0.01 \text{ GHz} \leq f \leq 25$  GHz

IL @ 12.89 GHz = 1.17 dB

where

IL @ 13.28 GHz = 1.20 dB

$f$  is the frequency in GHz

$IL_{catf}(f)$  is the reference test fixture printed circuit board insertion loss at frequency  $f$

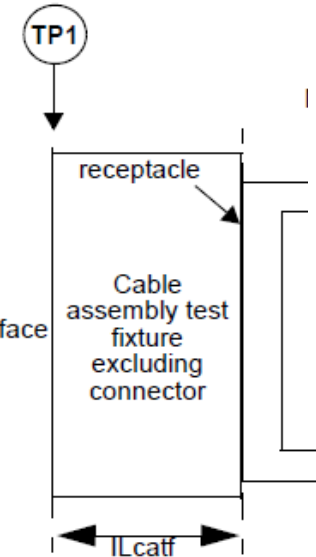

IL @ 12.89 GHz

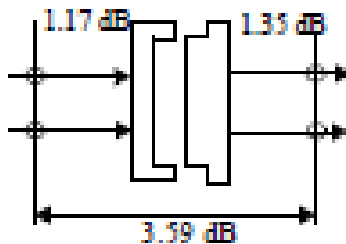

Mated cable assembly and test point test fixture

IL @ 13.28 GHz

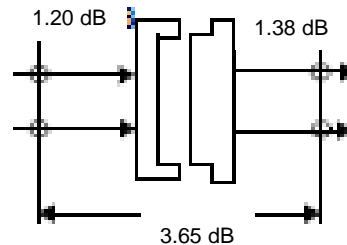

Mated cable assembly and test point test fixture

NOTE—The connector insertion loss is 1.07 dB for the mated test fixture. The host connector is allocated 0.62 dB of additional margin.

# Host Channel – Baseline

- Use transmitter and receiver differential printed circuit board trace loss max (with IL @ 13.28GHz) max
  - Specified in 92A.4 EQ(92A-1 – referenced 110A.4

NOTE—The connector insertion loss is 1.07 dB for the mated test fixture. The host connector is allocated 0.62 dB of additional margin. IL host connector @ 12.89 GHz =  $9.85 - 6.81 - 1.35 = 1.69$  dB

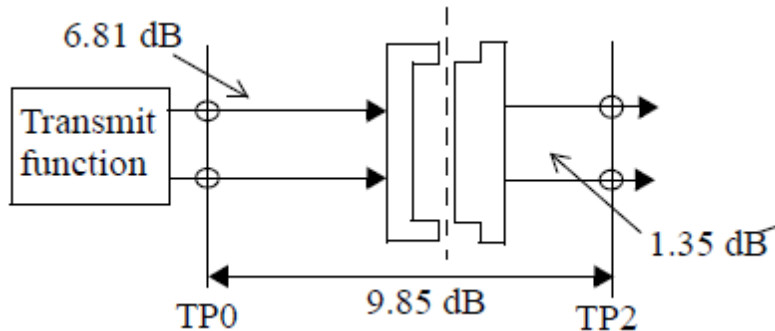

Host Loss budget at 12.8906 GHz

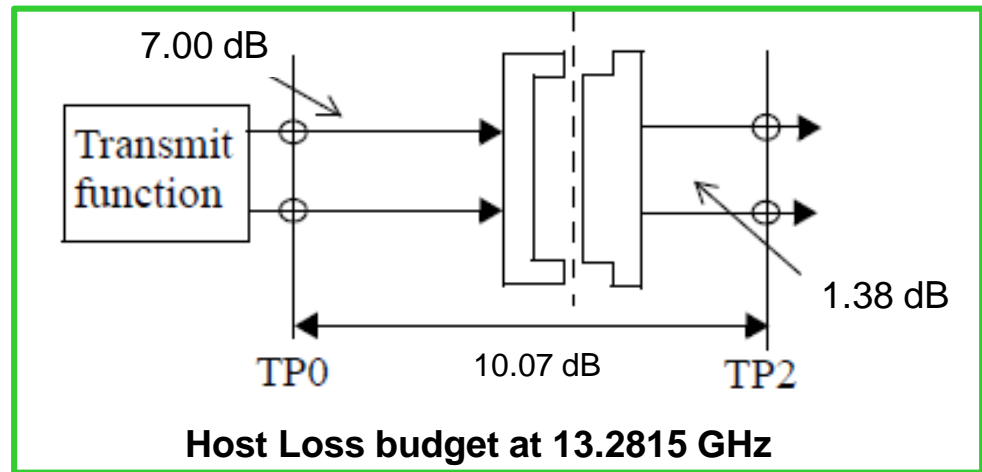

Host Loss budget at 13.2815 GHz

# Cable assembly IL max and min – Baseline

- Use 16.06 dB @ 13.28 as maximum cable assembly IL
- Use 802.3bj 92.10.2 Cable assembly insertion loss min equation (92-26) @ 13.28 GHz – referenced 110.10.2 – calculated as 8.3 dB @ 13.28 GHz

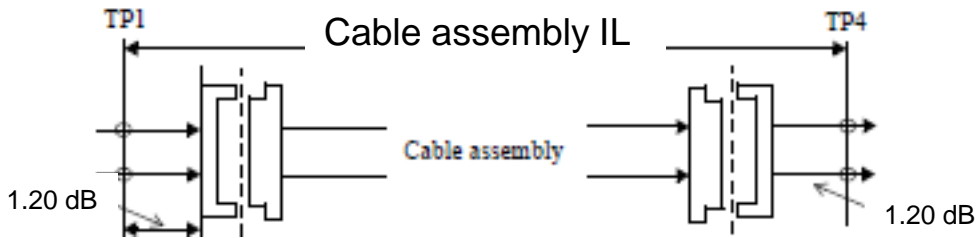

Bulk cable assumed @13.28 GHz = Cable assembly IL-(2\*1.20)+(2\*1.07)

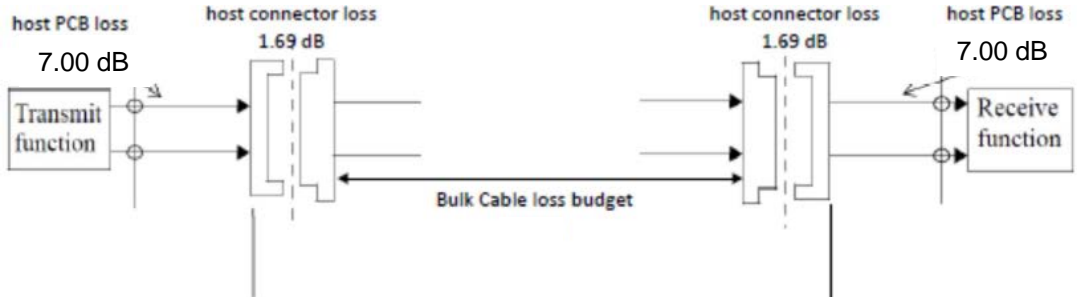

Bulk cable assumed @13.28 GHz = Channel IL- (2\*7)+(2\*1.69)

NOTE—The connector insertion loss is 1.07 dB for the mated test fixture. The host connector is allocated 0.62 dB of additional margin.

$$IL_{Cabmin}(f) = 0.7\sqrt{f} + 0.3f + 0.01f^2 \quad (\text{dB})$$

Equation 92-26

where  $f$  is the frequency in GHz  
 $IL_{Cabmin}(f)$  is the minimum cable assembly insertion loss at frequency  $f$

Channel IL (dB)@ 13.28 GHz	Max Cable assembly IL (db)@ 13.28 GHz	Bulk cable dB @ 13.28 GHz
28.0	15.16	10.62
28.1	15.26	10.72
28.2	15.36	10.82
28.3	15.46	10.92
28.4	15.56	11.02
28.5	15.66	11.12
28.6	15.76	11.22
28.7	15.86	11.32
28.8	15.96	11.42
28.9	16.06	11.52
29.0	16.16	11.62
29.1	16.26	11.72
29.2	16.36	11.82
29.3	16.46	11.92
29.4	16.56	12.02
29.5	16.66	12.12
29.6	16.76	12.22
29.7	16.86	12.32
29.8	16.96	12.42
29.9	17.06	12.52
30.0	17.16	12.62

# NGOATH Contributed Channel Data

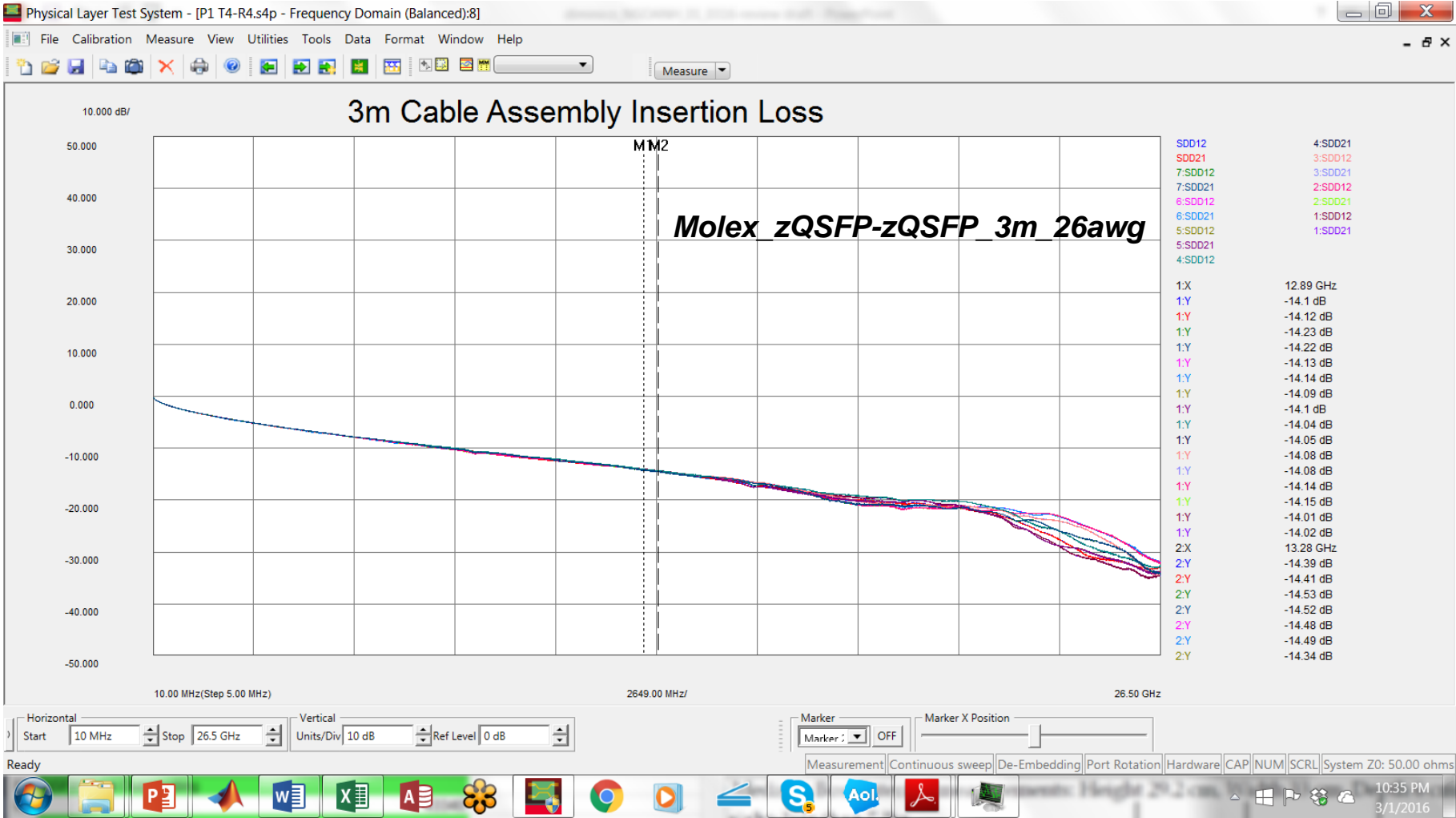

<http://www.ieee802.org/3/50G/public/channel/index.html>

Molex\_zQSFP-zQSFP\_3m\_26awg

# Channel Insertion Loss – Baseline

- Use form of channel insertion loss equations max and min with IL @ 13.28 GHz
  - Specified in 802.3bj Equation (92A–3) max and Equation (92A–5) min
  - Specified in 802.3by 110A.5 Channel insertion loss
    - Where frequency @ 13.28 GHz
      - + ILChmax = 28.90 dB, ILCamax = 16.06 dB
      - + ILChmin = 21.14 dB, ILCamin = 8.3 dB
      - + ILHost = 10.07 dB
      - + ILMatedTF = 3.65 dB

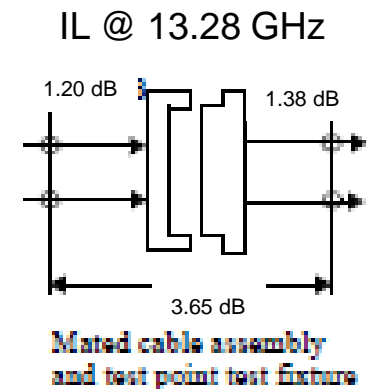
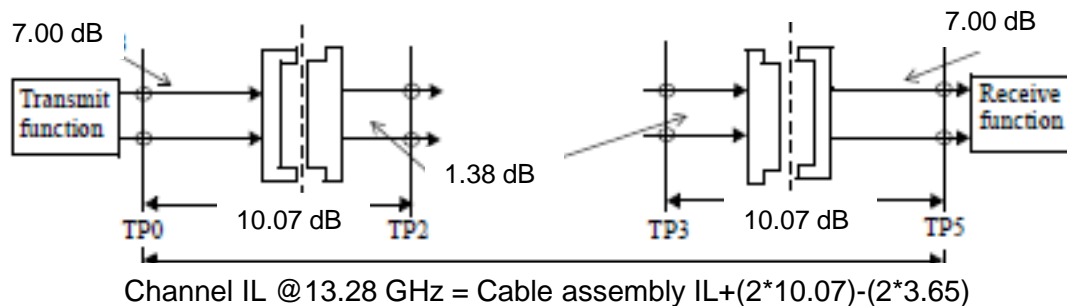

NOTE—The connector insertion loss is 1.07 dB for the mated test fixture. The host connector is allocated 0.62 dB of additional margin.

# Cable Assembly – Baseline (Use magenta RL/XTLK to indicate need to consider)

- Cable assembly - consistent with CL92 and CL110 – referenced parameters @ 13.28 GHz
- Use 16.06 dB @ 13.28 GHZ as maximum cable assembly IL
- Use 8.3 dB @ 13.28 GHZ as minimum cable assembly IL
- Use magenta font for return loss to indicate limit under consideration

Table 92-10—Cable assembly differential characteristics summary

Description	Reference	Value	Unit
Maximum insertion loss at 12.8906 GHz	92.10.2	22.48	dB
Minimum insertion loss at 12.8906 GHz	92.10.2	8	dB
Minimum return loss at 12.8906 GHz	92.10.3	6	dB
Differential to common-mode return loss	92.10.4	Equation (92-28)	dB
Differential to common-mode conversion loss	92.10.5	Equation (92-29)	dB
Common-mode to common-mode return loss	92.10.6	Equation (92-30)	dB

Table 110-10—Cable assembly characteristics summary

Description	Reference	CA-25G-L	CA-25G-S	CA-25G-N	Unit
Maximum insertion loss at 12.8906 GHz	110.10.2	22.48	16.48	15.5	dB
Minimum insertion loss at 12.8906 GHz	110.10.2	8			dB
Minimum differential return loss at 12.8906 GHz	110.10.3	6			dB
Differential to common-mode return loss	110.10.4	Equation (92-28)			dB
Differential to common-mode conversion loss	110.10.5	Equation (92-29)			dB
Common-mode to common-mode return loss	110.10.6	Equation (92-30)			dB
COM	110.10.7	See Table 110-11			dB

from  $[0.01/0.05/0.2] \leq f \leq 19$  GHz

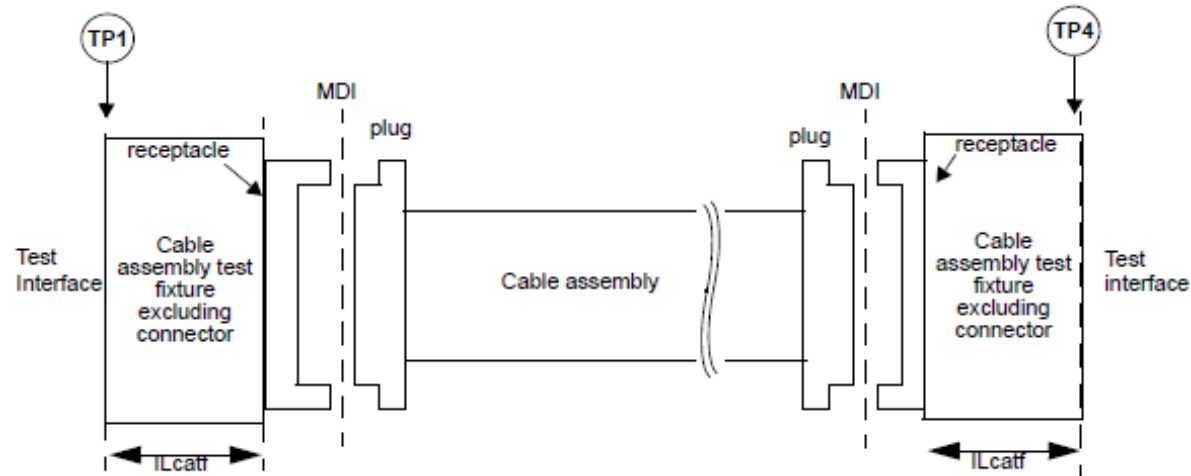

# COM- Baseline

- COM - consistent with methodology CL92 and CL110 – signaling rate 25.78125 GBd
- COM parameter values TBD

Table 110–11—COM parameter values

Parameter	Symbol	CA-25G-N	CA-25G-S	CA-25G-L <sup>a</sup>	Units
Signaling rate	$f_b$	25.78125			GBd
Maximum start frequency	$f_{min}$	0.05			GHz
Maximum frequency step <sup>b</sup>	$\Delta f$	0.01			GHz
Device package model					
Single-ended device capacitance	$C_d$	$2.5 \times 10^{-4}$			nF
Transmission line length, Test 1	$z_p$	12			mm
Transmission line length, Test 2	$z_p$	30			mm
Single-ended package capacitance at board interface	$C_p$	$1.5 \times 10^{-4}$			nF
Single-ended reference resistance	$R_0$	50			$\Omega$
Single-ended termination resistance	$R_d$	5 <sup>c</sup>			$\Omega$
Receiver 3 dB bandwidth		$0.5 \sim f_b$			GHz
Transmitter equalizer, minimum cursor coefficient	$\alpha(0)$	0.62			
Transmitter equalizer, pre-cursor coefficient	$\alpha(-1)$				
Minimum value		-0.18			
Maximum value		0			
Step size		0.02			
Transmitter equalizer, post-cursor coefficient	$\alpha(1)$				
Minimum value		-0.38			
Maximum value		0			
Step size		0.02			
Continuous time filter, DC gain	$g_{DC}$				
Minimum value		-16	-12	-12	dB
Maximum value		0	0	0	dB
Step size		1	1	1	dB
Continuous time filter, zero frequency	$f_z$	$f_b / 4$			GHz
Continuous time filter, pole frequencies	$f_{p1}$ $f_{p2}$	$f_b / 4$ $f_b$			GHz

Table 110–11—COM parameter values (continued)

Parameter	Symbol	CA-25G-N	CA-25G-S	CA-25G-L <sup>a</sup>	Units
Transmitter differential peak output voltage					
Victim	$A_v$	0.4			V
Far-end aggressor	$A_{fe}$	0.6			V
Near-end aggressor	$A_{ne}$	0.6			V
Number of signal levels	$L$	2			
Level separation mismatch ratio	$R_{LSM}$	1			
Transmitter signal-to-noise ratio	$SNR_{TX}$	28		27	dB
Number of samples per unit interval		3			
Decision feedback equalizer (DFE) length	$N_b$				
Normalized DFE coefficient magnitude limit, for $n = 1$ to $N_b$	$b_{max}(n)$	0.35	0.5	1	—
Random jitter, RMS	$\sigma_{RJ}$	0.01			UI
Dual-Dirac jitter, peak	$A_{DJ}$	0.05			UI
One-sided noise spectral density	$\eta_0$	$5.2 \times 10^{-8}$			V <sup>2</sup> /GHz
Target detector error ratio	$DER_0$	$10^{-12}$	$10^{-8}$	$10^{-5}$	—
Channel Operating Margin (min.)	COM	3 <sup>c</sup>	3	3	dB

<sup>a</sup>The parameters for CA-25G-L are the same as those for 100GBASE-CR4 (Table 93–8), except for  $A_b$ .

<sup>b</sup>For cable lengths greater than 4 m, a frequency step ( $\Delta f$ ) no larger than 5 MHz is recommended.

<sup>c</sup>For CA-25G-N cable assemblies with insertion loss at 12.8906 GHz greater than 12 dB, the minimum COM is relaxed to 2.2 dB.

Consider: <http://www.ieee802.org/3/bs/public/adhoc/elect/index.shtml>  
 COM update for Annex 120D (CDAUI-8 C2C) 12-Jan-16 (2157k)  
 config\_com\_ieee8023\_93a=CDAUI-8-C2C\_D1p1\_mellitz\_01\_0116.xls

# Test Fixtures

- Test Fixture specifications - consistent with CL92 and CL110
- Test fixtures specified in a mated state used for testing the transmitter, the receiver and cable assembly measurements
- The TP2/TP3 test fixture also known in the industry as Host Compliance Board (HCB) is required for measuring the transmitter specifications at TP2 and the receiver return loss at TP3.
- The cable assembly test fixture also known in the industry as Module Compliance Board (MCB) is required for measuring the cable assembly specifications at TP1 and TP4.

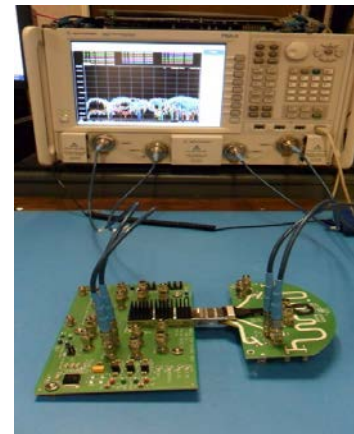
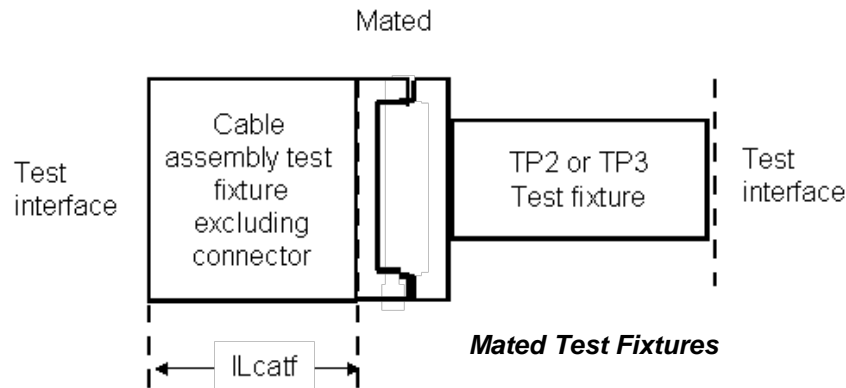



# Test Fixtures

- Test Fixture specifications – Adopt CL92 and CL110 – referenced parameters @ 13.28 GHz (signaling rate 25.78125 GBd).
- Use magenta font for return loss and ICN to indicate limit under consideration.

## Mated test fixtures parameters

Parameter description	Reference	f(GHz)	Unit
Maximum insertion Loss	92.11.3.1	$0.01 \leq f \leq 25$	dB
Minimum Insertion Loss	92.11.3.1	$0.01 \leq f \leq 25$	dB
Figure of Merit(FOM) ILD	92.11.3.1	$0.01 \leq f \leq 25$	dB
Minimum Return Loss	92.11.3.2	$0.01 \leq f \leq 25$	dB
Common-mode conversion insertion loss	92.11.3.3	$0.01 \leq f \leq 25$	dB
Common-mode return loss	92.11.3.4	$0.01 \leq f \leq 25$	dB
Common-mode to differential –mode return loss	92.11.3.5	$0.01 \leq f \leq 25$	dB
Integrated crosstalk noise	92.11.3.5 (QSFP28) 110B.1.3.6 (SFP28)		

# MDI/plug connector - Baseline

- MDI/Plug connector - Single-lane 50 Gb/s PHYs for operation – copper twin-axial cables (reference)
  - 110.11.1 Single-lane MDI connectors
    - + The single-lane MDI uses the SFP+ 28 Gb/s 1X Pluggable (SFP28) plug and receptacle as defined in SFF-8402 and SFF-8432.
- MDI/Plug connector – two-lane/four-lane 100/200 Gb/s PHY – copper twin-axial cables (references for two-lane/four-lane)
  - 92.12.1.1 Style-1 100GBASE-CR4 MDI connectors
    - + The plug connector for each end of the cable assembly QSFP+ 28 Gb/s 4X Pluggable (QSFP28) plugs defined in SFF-8665.
    - + The MDI connector shall be the QSFP+ 28 Gb/s 4X Pluggable (QSFP28) receptacle with the mechanical mating interface defined in SFF-8665.

---

# BACKUP

# IEEE 802.3bj: 100GBASE-CR4 Specifications

## Host Tx and Rx PCB losses

- Transmitter and receiver differential printed circuit board trace loss

GHz	dB/in
1	0.1856
6.5	0.8971
7	0.9557
12.89	1.5924
14	1.702

Attenuation* (dB/in) at:	1 GHz	6.5 GHz	7 GHz	12.89 GHz	14 GHz
Meg6_LowSR – Wide	0.0951	0.4159	0.4433	0.7562	0.8127
Meg6_LowSR – Narrow	0.1466	0.5849	0.6205	1.0152	1.0847
Meg6_HighSR – Wide	0.1175	0.5960	0.6367	1.0891	1.1688
Meg6_HighSR – Narrow	0.1856	0.8971	0.9557	1.5924	1.7020
ImpFR4_LowSR – Wide	0.1202	0.6096	0.6541	1.1772	1.2734
ImpFR4_LowSR – Narrow	0.1717	0.7794	0.8323	1.4410	1.5512
ImpFR4_HighSR – Wide	0.1427	0.7904	0.8484	1.5158	1.6367
ImpFR4_HighSR – Narrow	0.2106	1.0930	1.1692	2.0283	2.1813

\*using Algebraic Model v2.02a – see backup slides for values entered in Model

PROPOSED PARAMETERS;  
GRAPHS ON PREVIOUS SLIDE

[Proposal for Defining Material Loss](#)

26-Jan 12

Elizabeth  
Kochuparambil  
Joel Goergen

Cisco

[http://www.ieee802.org/3/bj/public/jan12/kochuparambil\\_01a\\_0112.pdf](http://www.ieee802.org/3/bj/public/jan12/kochuparambil_01a_0112.pdf)

12

802.3bj Cu specifications

[http://www.ieee802.org/3/bj/public/may12/diminico\\_01a\\_0512.pdf](http://www.ieee802.org/3/bj/public/may12/diminico_01a_0512.pdf)

802.3cd Task Force

# Channel Insertion Loss

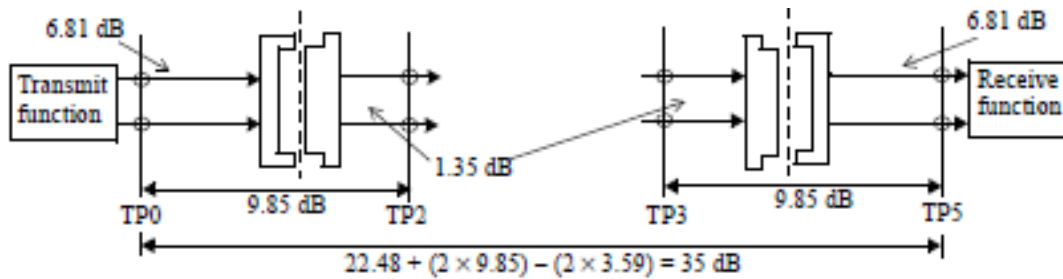

Channel IL @ 12.89 GHz = Cable assembly IL+(2\*9.85)-(2\*3.59)

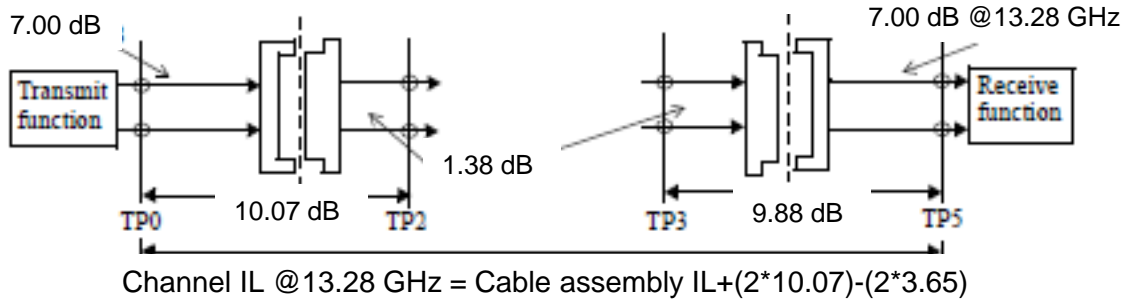

NOTE—The connector insertion loss is 1.07 dB for the mated test fixture. The host connector is allocated 0.62 dB of additional margin.

Table 110A-1—Cable insertion loss budget values at 12.8906 GHz

Parameter	CA-25G-L	CA-25G-S	CA-25G-N	Units
$IL_{Cltmax}$	35	29	28.02	dB
$IL_{Cltmax}$	22.48	16.48	15.50	dB
$IL_{Ch0.5m}$		20.52		dB
$IL_{Cltmin}$		8		dB
$IL_{Host}$		9.85		dB
$IL_{MatedITF}$		3.59		dB

IL @ 12.89 GHz

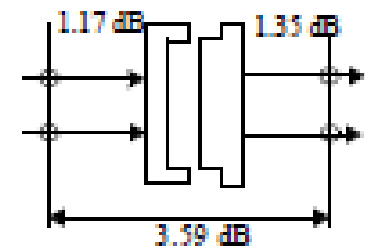

Mated cable assembly and test point test fixture

IL @ 13.28 GHz

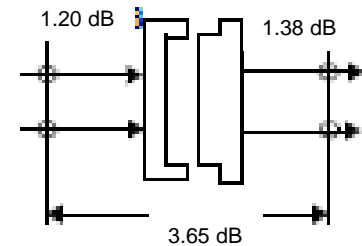

Mated cable assembly and test point test fixture

# QSFP28-Mated Test Fixture – 802.3bj/802.3by Specification

- Measurements 10 MHz-40 GHz

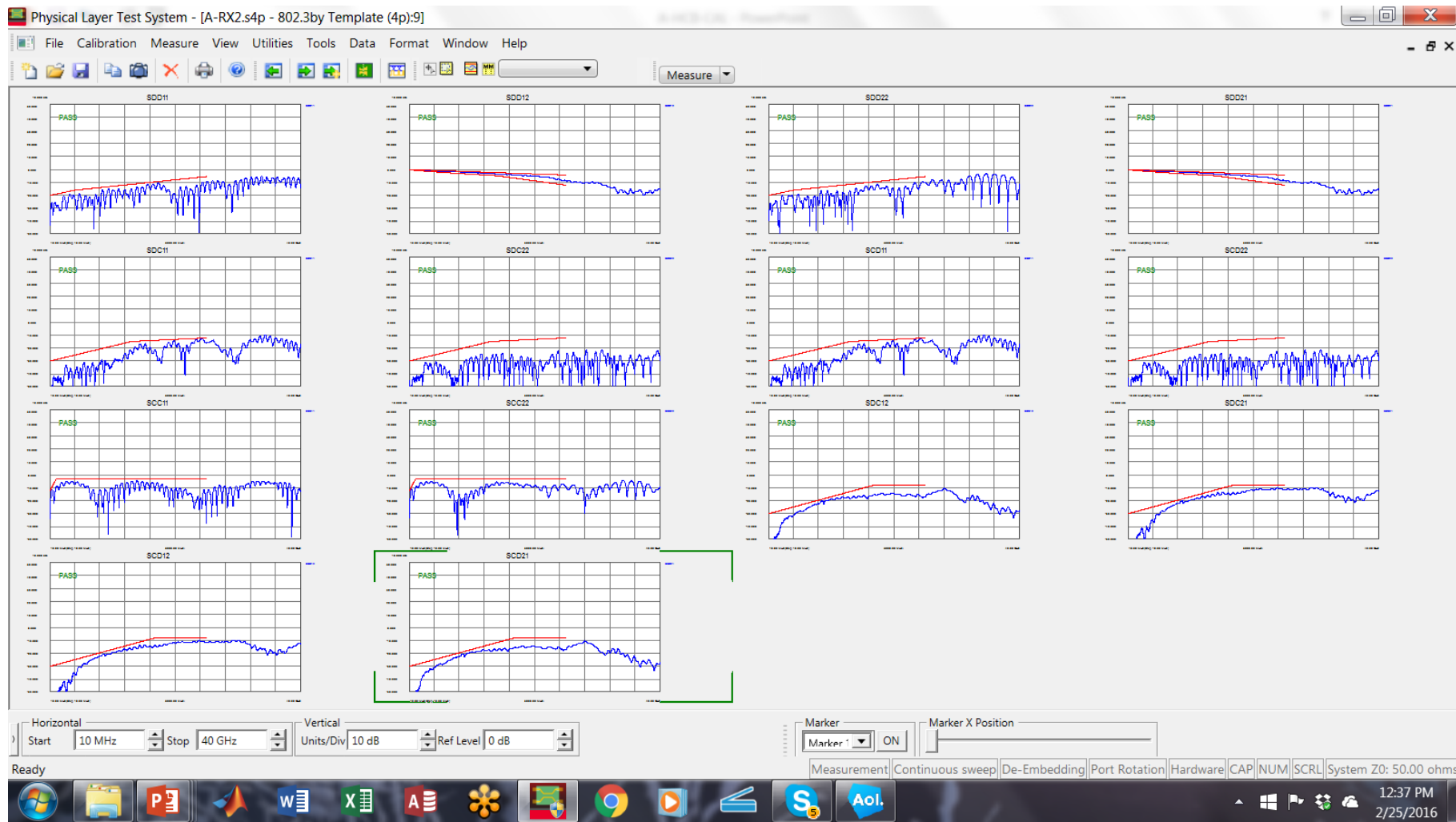

# SFP28-Mated Test Fixture – 802.3bj/802.3by Specification

- Measurements 10 MHz-40 GHz

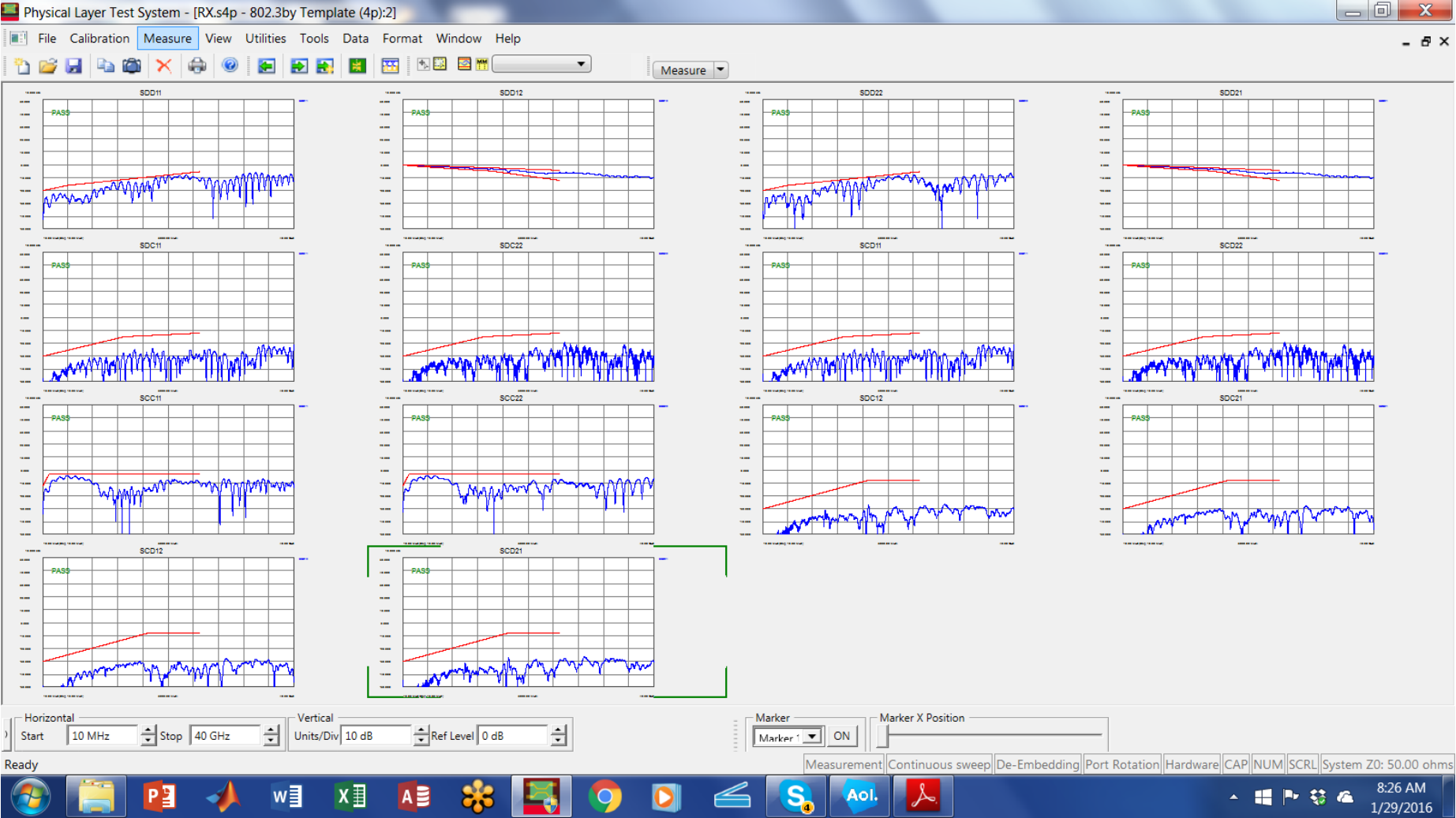

# QSFP28 MTF – Figure of merit – ILD

$FOM_{ILD}$  is calculated according to 93A.4 with  $f_b=25.78125$  GHz,  $T_f=9.6$  ps, and  $f_r=0.75 \times f_b$ . The fitted insertion loss and insertion loss deviation are computed over the range  $f_{min}=0.01$  GHz to  $f_{max}=25$  GHz.  $FOM_{ILD}$  shall be less than 0.13 dB.

Lane	$FOM_{ILD}$ (dB)
TX1	0.075
TX2	0.045
TX3	0.039
TX4	0.044
RX1	0.067
RX2	0.046
RX3	0.042
RX4	0.053

[http://www.ieee802.org/3/bm/public/jul14/plenary/diminico\\_01\\_0714\\_optx.pdf](http://www.ieee802.org/3/bm/public/jul14/plenary/diminico_01_0714_optx.pdf)



# SFP28 - Mated test fixture specifications - ICN

Table 110B–2—Mated test fixture integrated near-end crosstalk noise parameters

Description	Symbol	Value	Units
Symbol rate	$f_b$	25.78125	GBd
Near-end disturber peak differential output amplitude	$A_{nt}$	600	mV
Near-end disturber 20% to 80% rise and fall times	$T_{nt}$	9.6	ps

Table 110B–1—Mated test fixtures integrated near-end crosstalk noise

Parameter	Value	Units
Integrated near-end crosstalk noise voltage	Less than 1.8	mV

25.78125 GBd	MCB-TD-MCB-RD	HCB-TD-HCB-RD
NEXT ICN (mV)	0.945	0.926
26.5625 GBd	MCB-TD-MCB-RD	HCB-TD-HCB-RD
NEXT ICN (mV)	0.976	0.962

# QSFP28 - Mated test fixture specifications - ICN

Table 92-14—Mated test fixture integrated crosstalk noise parameters

Description	Symbol	Value	Units
Symbol rate	$f_b$	25.78125	GBd
Near-end disturber peak differential output amplitude	$A_{nt}$	600	mV
Far-end disturber peak differential output amplitude	$A_{ft}$	600	mV
Near-end disturber 20% to 80% rise and fall times	$T_{nt}$	9.6	ps
Far-end disturber 20% to 80% rise and fall times	$T_{ft}$	9.6	ps

Table 92-13—Mated test fixtures integrated crosstalk noise

Parameter	100GBASE-CR4	Units
MDNEXT integrated crosstalk noise voltage	less than 1.8	mV
MDFEXT integrated crosstalk noise voltage	less than 4.8	mV

25.78125 GBd /26.5625 GBd

	RX1	RX2	RX3	RX4
MDNEXT ICN (mV)	1.08	0.95	1.00	0.95
MDFEXT ICN (mV)	3.72	4.09	2.77	3.01
	TX1	TX2	TX3	TX4
MDNEXT ICN (mV)	1.39/1.47	1.13	1.11	0.81
MDFEXT ICN (mV)	4.17/4.27	3.19	3.74	3.00

[http://www.ieee802.org/3/bm/public/jul14/plenary/diminico\\_01\\_0714\\_optx.pdf](http://www.ieee802.org/3/bm/public/jul14/plenary/diminico_01_0714_optx.pdf)

# QSFP28 - Mated test fixture specifications - ICN

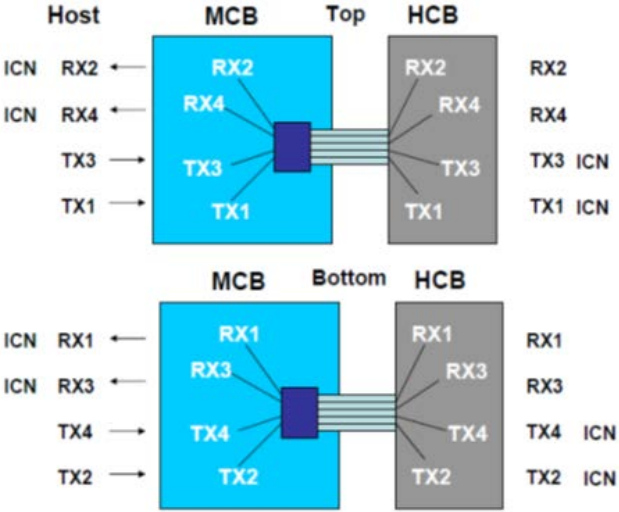

	RX1	RX2	TX1	TX2
MDNEXT ICN	0.81	0.79	1.19	1.00
MDFEXT ICN	2.12	2.57	2.66	2.29

- |            |                                   |                                   |            |
|------------|-----------------------------------|-----------------------------------|------------|
|            | <b>MCB-ICN-RX1</b>                | <b>MCB-ICN-TX1</b>                |            |
| <b>MCB</b> | <b>RX1-MDFEXT-RX2,RX3,RX4</b>     | <b>TX1-MDFEXT-TX2,TX3,TX4</b>     | <b>MCB</b> |
| <b>MCB</b> | <b>RX1-MDNEXT-TX1,TX2,TX3,TX4</b> | <b>TX1-MDNEXT-RX1,RX2,RX3,RX4</b> | <b>MCB</b> |
|            | <b>MCB-ICN-RX2</b>                | <b>MCB-ICN-TX2</b>                |            |
| <b>MCB</b> | <b>RX2-MDFEXT-RX1,RX3,RX4</b>     | <b>TX2-MDFEXT-TX1,TX3,TX4</b>     | <b>MCB</b> |
| <b>MCB</b> | <b>RX2-MDNEXT-TX1,TX2,TX3,TX4</b> | <b>TX2-MDNEXT-RX1,RX2,RX3,RX4</b> | <b>MCB</b> |
|            | <b>MCB-ICN-RX3</b>                | <b>MCB-ICN-TX3</b>                |            |
| <b>MCB</b> | <b>RX3-MDFEXT-RX1,RX2,RX4</b>     | <b>TX3-MDFEXT-TX1,TX2,TX4</b>     | <b>MCB</b> |
| <b>MCB</b> | <b>RX3-MDNEXT-TX1,TX2,TX3,TX4</b> | <b>TX3-MDNEXT-RX1,RX2,RX3,RX4</b> | <b>MCB</b> |
|            | <b>MCB-ICN-RX4</b>                | <b>MCB-ICN-TX4</b>                |            |
| <b>MCB</b> | <b>RX4-MDFEXT-RX1,RX2,RX3</b>     | <b>TX4-MDFEXT-TX1,TX2,TX3</b>     | <b>MCB</b> |
| <b>MCB</b> | <b>RX4-MDNEXT-TX1,TX2,TX3,TX4</b> | <b>TX4-MDNEXT-RX1,RX2,RX3,RX4</b> | <b>MCB</b> |

# CAUI/CDAUI chip-to-module interfaces

- CAUI-4 signaling rate for each lane is 25.78125 GBd<sup>1</sup>.

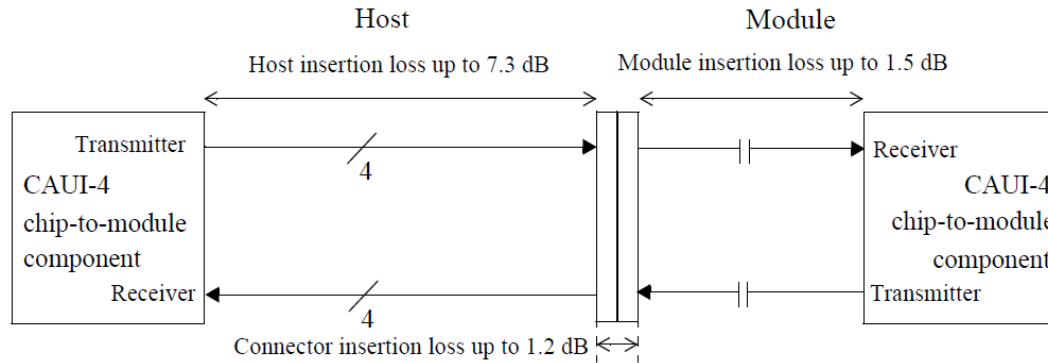

Figure 83E-2—Chip-to-module insertion loss budget at 12.89 GHz

- CDAUI-8 signaling rate for each lane is 26.5625 GBd<sup>2</sup>

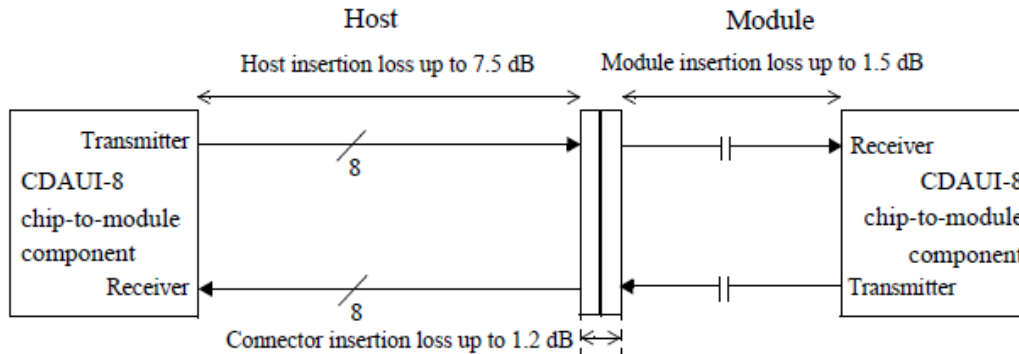

Figure 120E-2—Chip-to-module insertion loss budget at 13.28 GHz