

# Agenda and General Information

IEEE 802.3cf (IEEE 802.3.2))

YANG Data Model Definitions Task Force

Yan Zhuang, Huawei Technologies

New Orleans, LA, USA, May 25, 2017

# Agenda

---

- Appointment of Recording Secretary
- Welcome and Introductions
- Approve Agenda
- Approve Minutes
- Reflector and Web
- Ground Rules
- IEEE
  - Structure, Bylaws and Rules
  - Call for Patents
  - IEEE Standards Process
- Liaisons and Communications
- Goals for this meeting
- Schedule and Presentations
- Motions and Closing Business
- Future Meetings

# P802.3cf Task Force organization

---

- Chair: Yan Zhuang, Huawei
- Chief Editor: Marek Hajduczenia, Charter
- Ad hoc Chair: Peter Jones, Cisco

# Task Force Decorum

---



- Photography or recording by permission only (December 2014 IEEE-SA Standards Board Ops Manual 5.3.3.2)
- Press (i.e., anyone reporting publicly on this meeting) are to announce their presence (December 2014 IEEE-SA Standards Board Ops Manual 5.3.3.3)
- Cell phone ringers off
- Wear your badges at all times in meeting areas
  - Help the hotel security staff improve the general security of the meeting rooms
  - **PCs HAVE BEEN STOLEN** at previous meetings
  - **DO NOT** assume that meeting areas are secure
- Please observe proper decorum in meetings

# Reflector and Web

---

- To subscribe to the YANG Data Model Definitions Task Force reflector, send an email to:

[ListServ@ieee.org](mailto:ListServ@ieee.org)

with the following in the body of the message (do not include “<>”):

*subscribe* **stds-802-3-YANG** *<yourfirstname>* *<yourlastname>*  
*end*

- Send the YANG Data Model Definitions Task Force reflector messages to:  
[stds-802-3-YANG-request@listserv.ieee.org](mailto:stds-802-3-YANG-request@listserv.ieee.org)

- Task Force web page URL:

<http://www.ieee802.org/3/cf/index.html>

# Ground Rules

---

- Based upon IEEE 802.3 Rules
  - Foundation based upon Robert's Rules of Order
  - Anyone in the room may speak
  - Anyone in the room may vote
- **RESPECT**... give it, get it
- NO product pitches
- NO corporate pitches
- NO prices!!!
  - This includes costs, ASPs, etc. no matter what the currency
- NO restrictive notices

# Attendance

---

- Tutorial Material on attendance tool
  - [http://ieee802.org/3/minutes/attendance\\_procedures.pdf](http://ieee802.org/3/minutes/attendance_procedures.pdf)
- Access details
  - URL: <http://imat.ieee.org/>
  - Use your imat login
    - (must be on meeting SDID –no VPN)

# IEEE Structure

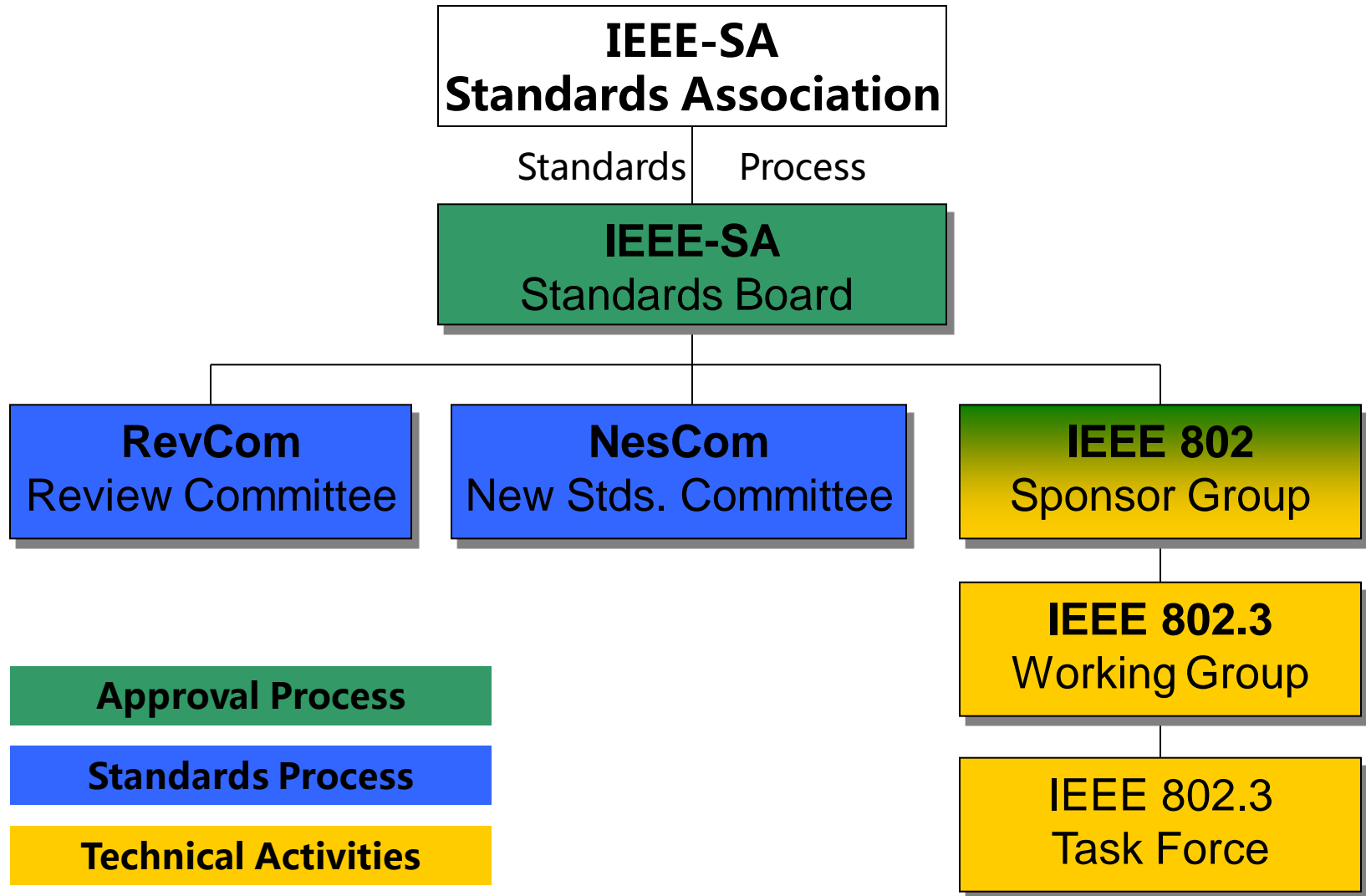



# Important Bylaws and Rules

---

- **IEEE-SA Operations Manual**  
[http://standards.ieee.org/develop/policies/sa\\_opman/](http://standards.ieee.org/develop/policies/sa_opman/)
- **IEEE-SA Standards Board Bylaws**  
<http://standards.ieee.org/develop/policies/bylaws/>
- **IEEE-SA Standards Board Operations Manual**  
<http://standards.ieee.org/develop/policies/opman/>
- **IEEE 802 LAN/MAN Standards Committee (LMSC) Policies and Procedures**  
<http://standards.ieee.org/about/sasb/audcom/pnp/LMSC.pdf>
- **IEEE 802 LAN/MAN Standards Committee (LMSC) Operations Manual**  
<http://www.ieee802.org/devdocs.shtml>
- **IEEE 802 LAN/MAN Standards Committee (LMSC) Working Group (WG) Policies and Procedures**  
<http://www.ieee802.org/devdocs.shtml>
- **IEEE 802.3 Working Group Operating Rules**  
[http://ieee802.org/3/rules/P802\\_3\\_rules.pdf](http://ieee802.org/3/rules/P802_3_rules.pdf)

# Instructions for the WG Chair

The IEEE-SA strongly recommends that at each WG meeting the chair or a designee:

- **Show slides #1 through #4 of this presentation**
- **Advise the WG attendees that:**
  - The IEEE's patent policy is described in Clause 6 of the *IEEE-SA Standards Board Bylaws*;
  - Early identification of patent claims which may be essential for the use of standards under development is strongly encouraged;
  - There may be Essential Patent Claims of which the IEEE is not aware. Additionally, neither the IEEE, the WG, nor the WG chair can ensure the accuracy or completeness of any assurance or whether any such assurance is, in fact, of a Patent Claim that is essential for the use of the standard under development.
- **Instruct the WG Secretary to record in the minutes of the relevant WG meeting:**
  - That the foregoing information was provided and that slides 1 through 4 (and this slide 0, if applicable) were shown;
  - That the chair or designee provided an opportunity for participants to identify patent claim(s)/patent application claim(s) and/or the holder of patent claim(s)/patent application claim(s) of which the participant is personally aware and that may be essential for the use of that standard
  - Any responses that were given, specifically the patent claim(s)/patent application claim(s) and/or the holder of the patent claim(s)/patent application claim(s) that were identified (if any) and by whom.
- The WG Chair shall ensure that a request is made to any identified holders of potential essential patent claim(s) to complete and submit a Letter of Assurance.
- It is recommended that the WG chair review the guidance in *IEEE-SA Standards Board Operations Manual* 6.3.5 and in FAQs 14 and 15 on inclusion of potential Essential Patent Claims by incorporation or by reference.

Note: **WG** includes Working Groups, Task Groups, and other standards-developing committees with a PAR approved by the IEEE-SA Standards Board.



15 March 2015

(Optional to be shown)

# Participants, Patents, and Duty to Inform

All participants in this meeting have certain obligations under the IEEE-SA Patent Policy.

- Participants [Note: Quoted text excerpted from IEEE-SA Standards Board Bylaws subclause 6.2]:
  - “Shall inform the IEEE (or cause the IEEE to be informed)” of the identity of each “holder of any potential Essential Patent Claims of which they are personally aware” if the claims are owned or controlled by the participant or the entity the participant is from, employed by, or otherwise represents
  - “Should inform the IEEE (or cause the IEEE to be informed)” of the identity of “any other holders of potential Essential Patent Claims” (that is, third parties that are not affiliated with the participant, with the participant’s employer, or with anyone else that the participant is from or otherwise represents)
- The above does not apply if the patent claim is already the subject of an Accepted Letter of Assurance that applies to the proposed standard(s) under consideration by this group
- Early identification of holders of potential Essential Patent Claims is strongly encouraged
- No duty to perform a patent search

# Patent Related Links

All participants should be familiar with their obligations under the IEEE-SA Policies & Procedures for standards development.

Patent Policy is stated in these sources:

IEEE-SA Standards Boards Bylaws

*<http://standards.ieee.org/develop/policies/bylaws/sect6-7.html#6>*

IEEE-SA Standards Board Operations Manual

*<http://standards.ieee.org/develop/policies/opman/sect6.html#6.3>*

Material about the patent policy is available at

*<http://standards.ieee.org/about/sasb/patcom/materials.html>*

If you have questions, contact the IEEE-SA Standards Board Patent Committee Administrator at [patcom@ieee.org](mailto:patcom@ieee.org) or visit <http://standards.ieee.org/about/sasb/patcom/index.html>

This slide set is available at  
<https://development.standards.ieee.org/myproject/Public/mytools/mob/slideset.ppt>



# Call for Potentially Essential Patents

- If anyone in this meeting is personally aware of the holder of any patent claims that are potentially essential to implementation of the proposed standard(s) under consideration by this group and that are not already the subject of an Accepted Letter of Assurance:
  - Either speak up now or
  - Provide the chair of this group with the identity of the holder(s) of any and all such claims as soon as possible or
  - Cause an LOA to be submitted

# Other Guidelines for IEEE WG Meetings

- **All IEEE-SA standards meetings shall be conducted in compliance with all applicable laws, including antitrust and competition laws.**
  - **Don't discuss the interpretation, validity, or essentiality of patents/patent claims.**
  - **Don't discuss specific license rates, terms, or conditions.**
    - Relative costs, including licensing costs of essential patent claims, of different technical approaches may be discussed in standards development meetings.
      - Technical considerations remain primary focus
  - **Don't discuss or engage in the fixing of product prices, allocation of customers, or division of sales markets.**
  - **Don't discuss the status or substance of ongoing or threatened litigation.**
  - **Don't be silent if inappropriate topics are discussed ... do formally object.**

-----  
See *IEEE-SA Standards Board Operations Manual*, clause 5.3.10 and “Promoting Competition and Innovation: What You Need to Know about the IEEE Standards Association’s Antitrust and Competition Policy” for more details.

# Participation in IEEE 802 Meetings

- | All participation in IEEE 802 Working Group meetings is on an individual basis
    - *Participants in the IEEE standards development individual process shall act based on their qualifications and experience.*  
([https://standards.ieee.org/develop/policies/bylaws/sb\\_bylaws.pdf](https://standards.ieee.org/develop/policies/bylaws/sb_bylaws.pdf) section 5.2.1)
    - *IEEE 802 Working Group membership is by individual; “Working Group members shall participate in the consensus process in a manner consistent with their professional expert opinion as individuals, and not as organizational representatives”.*  
([http://ieee802.org/PNP/approved/IEEE\\_802\\_WG\\_PandP\\_v19.pdf](http://ieee802.org/PNP/approved/IEEE_802_WG_PandP_v19.pdf) section 4.2.1)
  - You have an obligation to act and vote as an individual and not under the direction of any other individual or group. Your obligation to act and vote as an individual applies in all cases, regardless of any external commitments, agreements, contracts, or orders.
  - You shall not direct the actions or votes of any other member of an IEEE 802 Working Group or retaliate against any other member for their actions or votes within IEEE 802 Working Group meetings, see [https://standards.ieee.org/develop/policies/bylaws/sb\\_bylaws.pdf](https://standards.ieee.org/develop/policies/bylaws/sb_bylaws.pdf) section 5.2.1.3 and [http://ieee802.org/PNP/approved/IEEE\\_802\\_WG\\_PandP\\_v19.pdf](http://ieee802.org/PNP/approved/IEEE_802_WG_PandP_v19.pdf) section 3.4.1, list item x
- | By participating in IEEE 802 meetings, you accept these requirements. If you do not agree to these policies then you shall not participate.
- | Link to the slides: <http://www.ieee802.org/devdocs.shtml>

# Overview of IEEE 802.3 Standards Process (1/5)- Study Group Phase

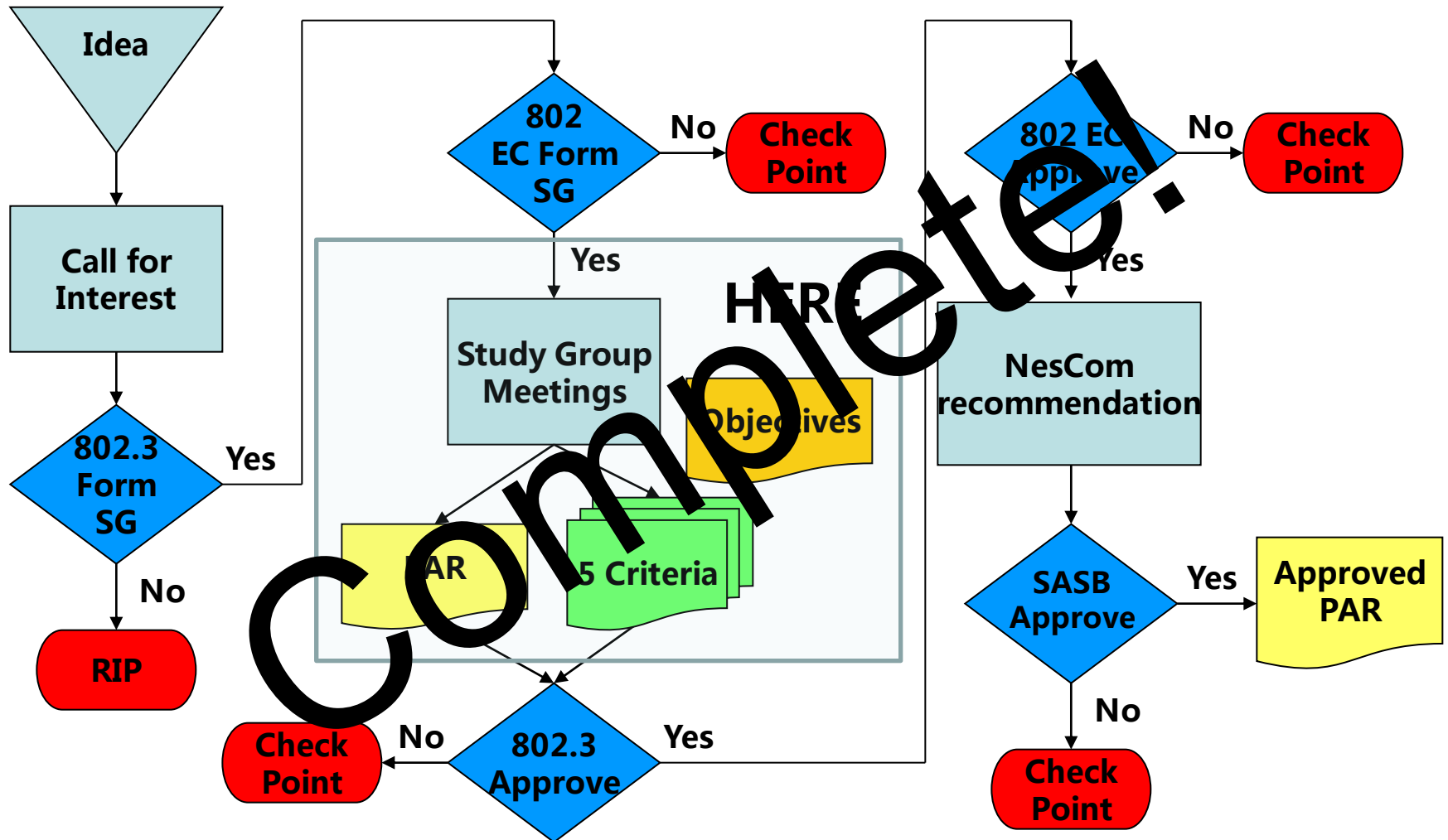

Note: At "Check Point", either the activity is ended, or there may be various options that would allow reconsideration of the approval.



# Overview of IEEE 802.3 Standards Process (2/5) – Task Force Comment Phase

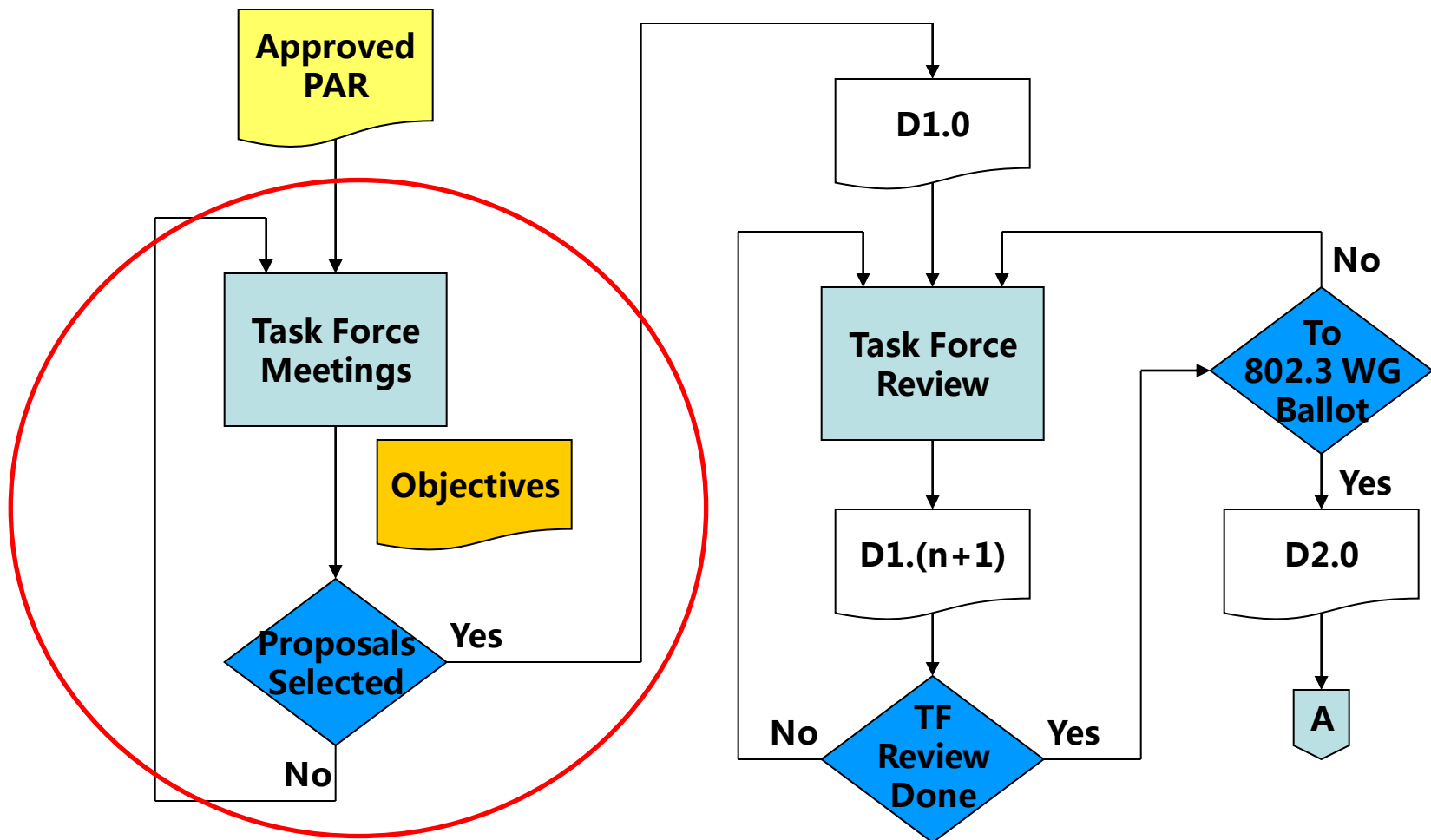

We are here.

# Overview of IEEE 802.3 Standards Process (3/5) – Working Group Ballot Phase

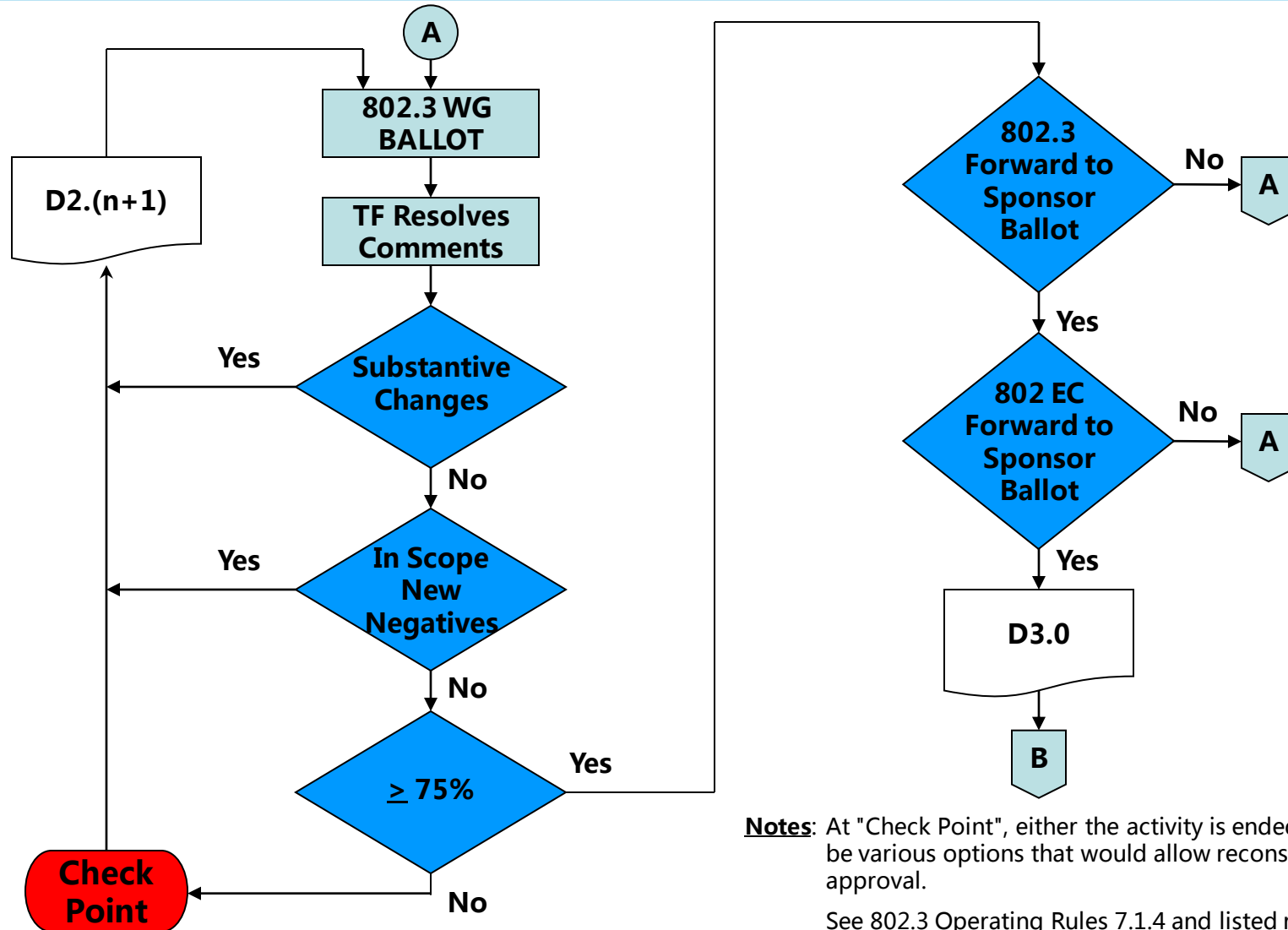

**Notes:** At "Check Point", either the activity is ended, or there may be various options that would allow reconsideration of the approval.

See 802.3 Operating Rules 7.1.4 and listed references for complete description

# Overview of IEEE 802.3 Standards Process (4/5)- Sponsor Ballot Phase

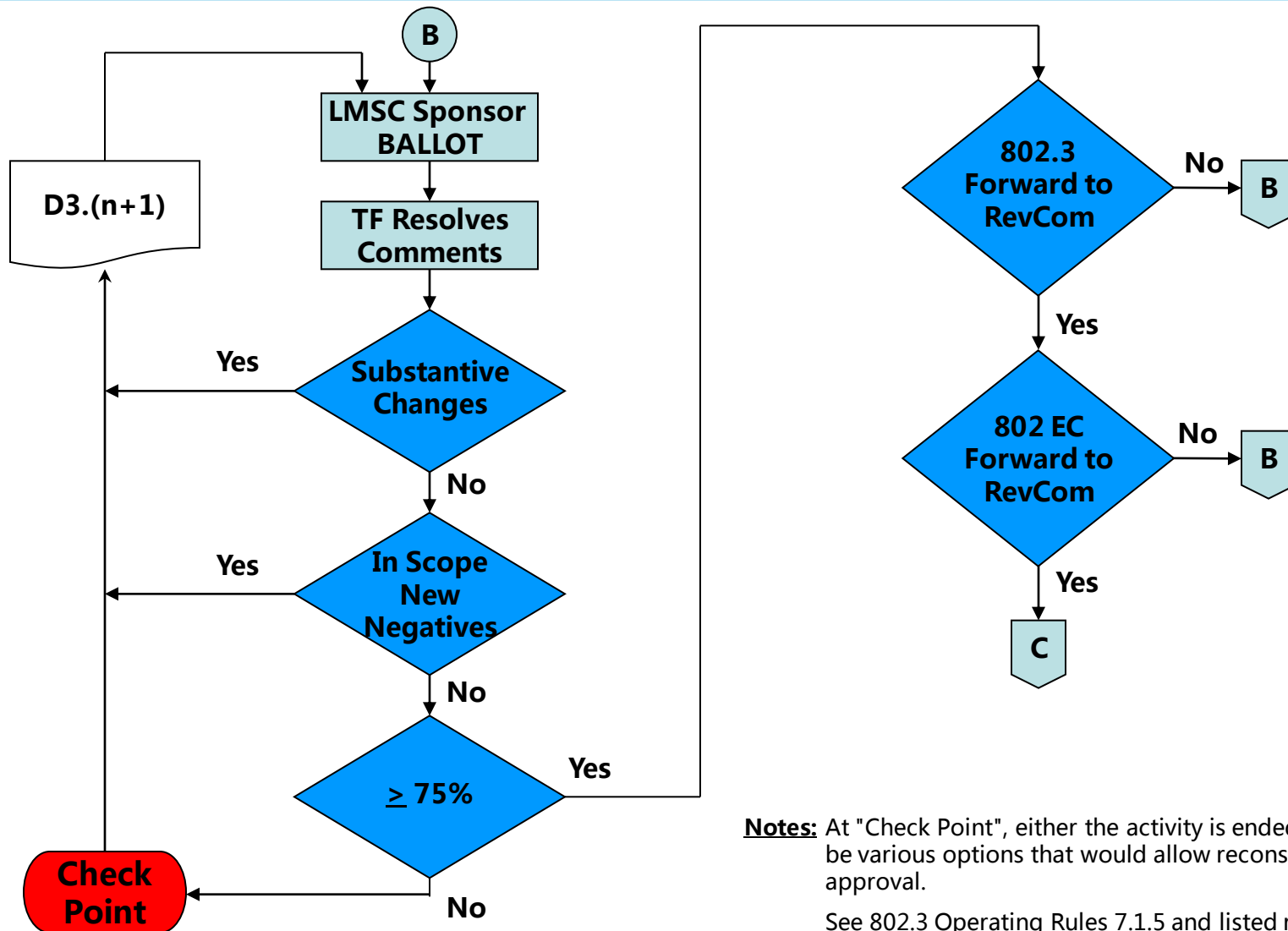

**Notes:** At "Check Point", either the activity is ended, or there may be various options that would allow reconsideration of the approval.

See 802.3 Operating Rules 7.1.5 and listed references for complete description

# Overview of IEEE 802.3 Standards Process (5/5) – Final Approvals / Standard Release

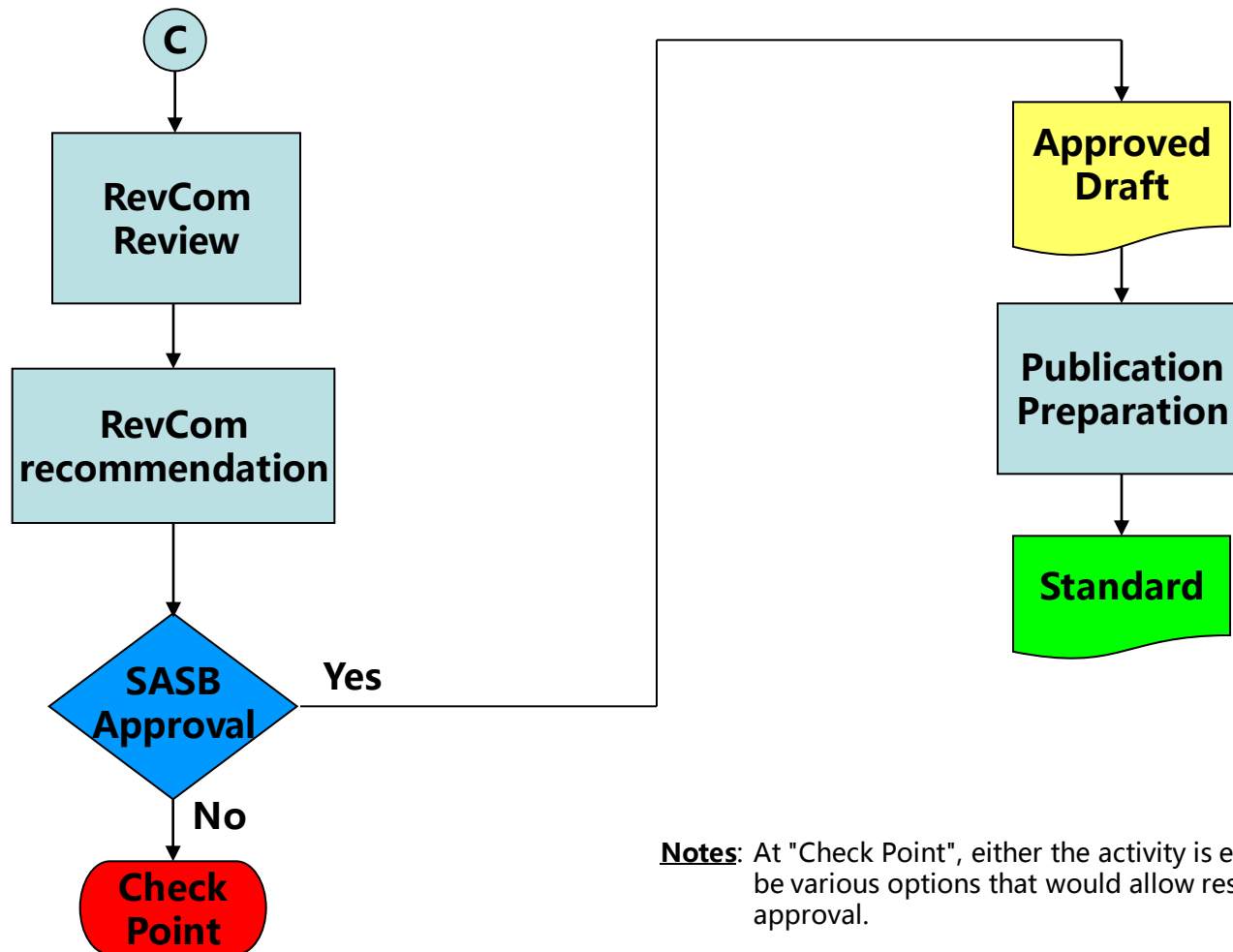

**Notes:** At "Check Point", either the activity is ended, or there may be various options that would allow resubmission for approval.

# IEEE P802.3.2 (IEEE 802.3cf) YANG Data Model Definitions Task Force Approved Project Documents

---

- PAR
  - [http://www.ieee802.org/3/cf/IEEE\\_P802d3d2\\_220916\\_PAR.pdf](http://www.ieee802.org/3/cf/IEEE_P802d3d2_220916_PAR.pdf)
- Approved CSD
  - <http://www.ieee802.org/3/cf/ec-16-0142-00-ACSD-802-3cf.pdf>
- Approved Objectives
  - [http://www.ieee802.org/3/cf/YANG\\_SG\\_objectives\\_v1.6.pdf](http://www.ieee802.org/3/cf/YANG_SG_objectives_v1.6.pdf)
- Timeline
  - TBD

# IEEE P802.3.2 (IEEE 802.3cf) YANG Data Model Definitions Task Force Approved Project Documents

---

Define YANG Models based on IEEE Std 802.3-2015 for:

- Selected MAC/RS and PHYs
- Multi Point Control Protocol (MPCP)
- DTE Power via medium dependent Interface (MDI)
- Operations, Administration, and Maintenance (OAM)

# IEEE P802.3.2(.3cf) Task Force Draft Timeline

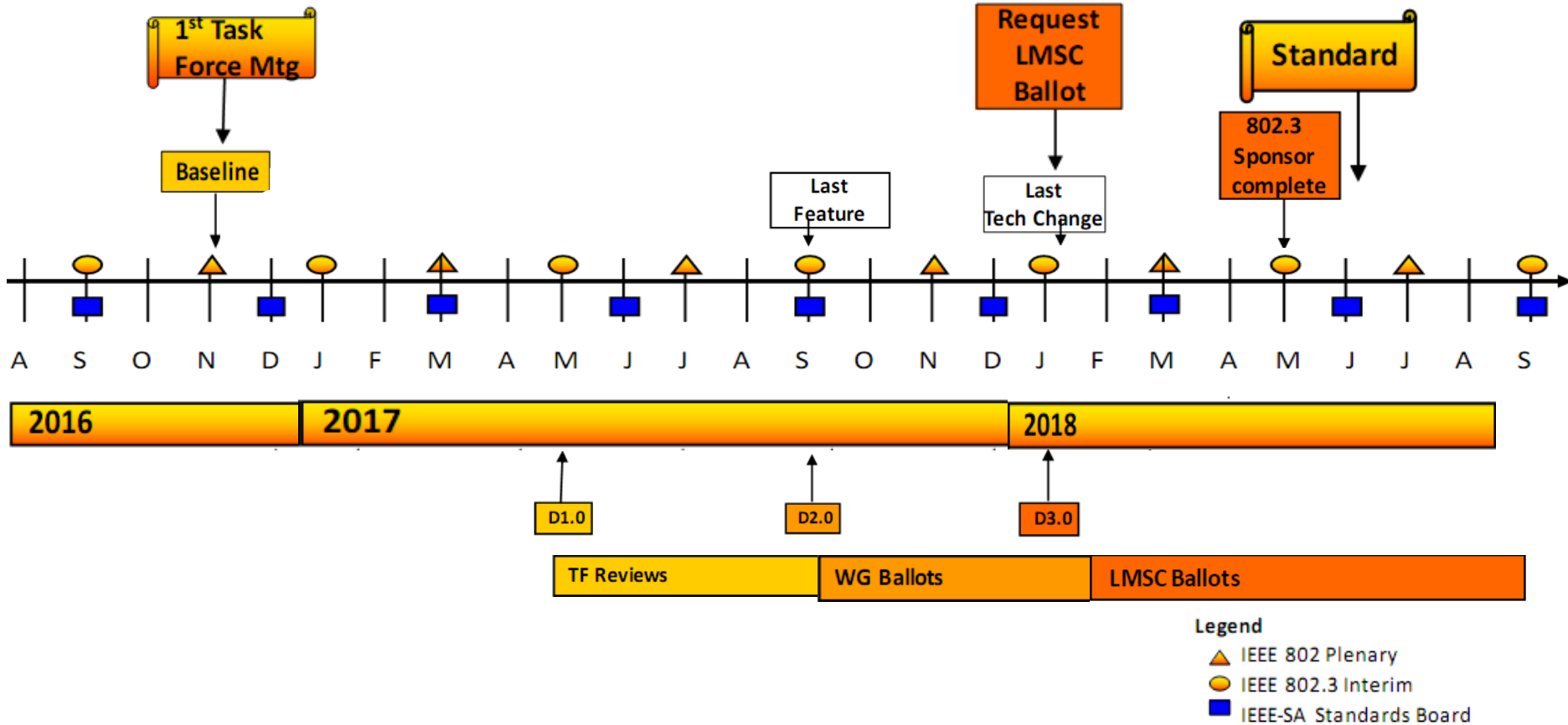

Draft proposal

# Goals for the meeting

---

- Meeting goals:
  - Review and adopt baseline texts on EPON module
  - Resolve comments on D0.1
  - Check the timeline
  - Lay the ground work for the next meeting



# Presentations

<b>Thursday PM</b>	<b>Time</b>	<b>Presenter</b>	<b>Affiliation</b>	<b>Title</b>	<b>Duration</b>
25-May-17	1:30PM	Yan Zhuang	Huawei	Agenda and General Info.	00:30
	2:00PM	Peter Jones	Cisco	Ad hoc report	00:10
	2:10PM	Marek Hajduczenia	Charter	Commenting process	00:20
	2:30PM	Marek Hajduczenia	Charter	EPON module	00:30
	3:00PM	break			00:30
	3:30PM	Marek Hajduczenia	Charter	Comments resolution	00:50
	4:20PM	Yan Zhuang	Huawei	Objectives discussion	00:20
	4:40PM	Discussions& Straw Polls& Motions			00:35

Note –Times listed are subject to change.

# Future Meetings

---

- See: <http://www.ieee802.org/3/interims/index.html>
- Ad-hoc meeting plans
  - Bi-weekly meetings if needed, all topics (will cycle) – agendas will be published. 1 hr duration.
- July 2017 Plenary
  - Week of July 10, 2017 -- Berlin, Germany
- September 2017 Interim
  - Week of September 11, 2017 –Charlotte, NC, USA
- November 2017 Plenary
  - Week of November 6, 2017 – Orlando, FL, USA
- Anyone interested in hosting a interim meeting contact me or the IEEE 802.3 Executive Secretary [Steve Carlson](#).

---

# Thank You!