

Agenda and General Information

IEEE 802.3cf (IEEE 802.3.2)

YANG Data Model Definitions Task Force

Yan Zhuang, Huawei Technologies

Pittsburgh, PA, USA, May 21, 2018

Agenda

- Welcome and Introductions
- Approve Agenda
- Approve Minutes
- Goals for this meeting
- Big Ticket Items
- Reflector and Web
- Ground Rules
- IEEE
 - Structure, Bylaws and Rules
 - Call for Patents
 - IEEE Standards Process
- Liaisons and Communications
- Comment resolution
- Presentations
- Motions and Closing Business
- Future Meetings

Task Force Decorum



- An officer is permitted to make an audio or slideshow recording of this meeting exclusively for the purpose of generating minutes which shall not be copied or distributed. **IEEE 802.3 meetings do not use this option.** Recording of the proceedings by any other participant or observer, in part or in whole, via any means, is prohibited. (December 2017 IEEE-SA Standards Board Ops Manual 5.3.3.2)
- Press (i.e., anyone reporting publicly on this meeting) are to announce their presence (December 2017 IEEE-SA Standards Board Ops Manual 5.3.3.3)
- Cell phone ringers off
- Wear your badges at all times in meeting areas
 - Help the hotel security staff improve the general security of the meeting rooms
 - **PCs HAVE BEEN STOLEN** at previous meetings
 - **DO NOT** assume that meeting areas are secure
- Please observe proper decorum in meetings

Goals for the meeting

- Review comments on D2.1
- Move to recir
- Lay the ground work for the next meeting

Reflector and Web

- To subscribe to the YANG Data Model Definitions reflector, send an email to:

ListServ@ieee.org

with the following in the body of the message (do not include “<>”):

subscribe stds-802-3-YANG <yourfirstname> <yourlastname>
end

- Send YANG Data Model Definitions Task Force reflector messages to:

stds-802-3-YANG-request@listserv.ieee.org

- Task Force web page URL:

<http://www.ieee802.org/3/cf/index.html>

Task Force Private Area

- URL: <http://www.ieee802.org/3/cf/private/index.html>
 - Username: <<XXXXXX>>
 - Password: <<XXXXXXXX>>
- Write it down...
- Note - The draft, and any other content, is posted for your review only, and neither the content nor access information should be copied or redistributed to others in violation of document copyrights.

Ground Rules

- Based upon IEEE 802.3 Rules
 - Foundation based upon Robert's Rules of Order
 - Anyone in the room may speak
 - Anyone in the room may vote
- **RESPECT**... give it, get it
- NO product pitches
- NO corporate pitches
- NO prices!!!
 - This includes costs, ASPs, etc. no matter what the currency
- NO restrictive notices

Attendance

- Tutorial Material on attendance tool
 - http://ieee802.org/3/minutes/attendance_procedures.pdf
- Access details
 - URL: <http://imat.ieee.org/>
 - (For interim) Password will be provided

Note: Ensure that password does not appear in version of slides posted on public web site.

IEEE Structure

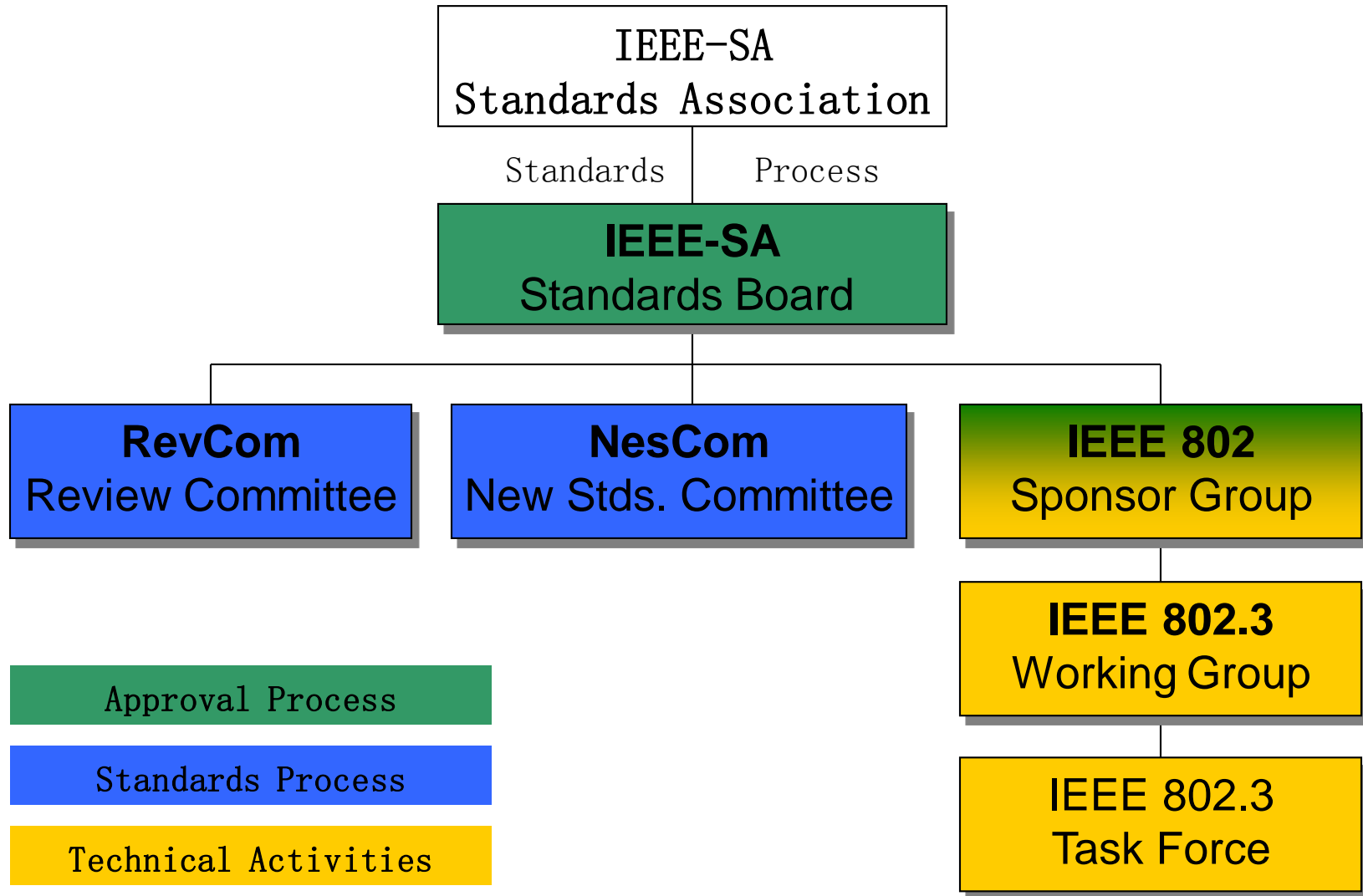

Important Bylaws and Rules

- **IEEE-SA Operations Manual**
http://standards.ieee.org/develop/policies/sa_opman/
- **IEEE-SA Standards Board Bylaws**
<http://standards.ieee.org/develop/policies/bylaws/>
- **IEEE-SA Standards Board Operations Manual**
<http://standards.ieee.org/develop/policies/opman/>
- **IEEE 802 LAN/MAN Standards Committee (LMSC) Policies and Procedures**
<http://standards.ieee.org/about/sasb/audcom/pnp/LMSC.pdf>
- **IEEE 802 LAN/MAN Standards Committee (LMSC) Operations Manual**
<http://www.ieee802.org/devdocs.shtml>
- **IEEE 802 LAN/MAN Standards Committee (LMSC) Working Group (WG) Policies and Procedures**
<http://www.ieee802.org/devdocs.shtml>
- **IEEE 802.3 Working Group Operating Rules**
http://ieee802.org/3/rules/P802_3_rules.pdf

Instructions for the WG Chair

The IEEE-SA strongly recommends that at each WG meeting the chair or a designee:

- **Show slides #1 through #4 of this presentation**
- **Advise the WG attendees that:**
 - IEEE's patent policy is described in Clause 6 of the *IEEE-SA Standards Board Bylaws*;
 - Early identification of patent claims which may be essential for the use of standards under development is strongly encouraged;
 - There may be Essential Patent Claims of which IEEE is not aware. Additionally, neither IEEE, the WG, nor the WG Chair can ensure the accuracy or completeness of any assurance or whether any such assurance is, in fact, of a Patent Claim that is essential for the use of the standard under development.
- **Instruct the WG Secretary to record in the minutes of the relevant WG meeting:**
 - That the foregoing information was provided and that slides 1 through 4 (and this slide 0, if applicable) were shown;
 - That the chair or designee provided an opportunity for participants to identify patent claim(s)/patent application claim(s) and/or the holder of patent claim(s)/patent application claim(s) of which the participant is personally aware and that may be essential for the use of that standard
 - Any responses that were given, specifically the patent claim(s)/patent application claim(s) and/or the holder of the patent claim(s)/patent application claim(s) that were identified (if any) and by whom.
- The WG Chair shall ensure that a request is made to any identified holders of potential essential patent claim(s) to complete and submit a Letter of Assurance.
- It is recommended that the WG Chair review the guidance in *IEEE-SA Standards Board Operations Manual* 6.3.5 and in FAQs 14 and 15 on inclusion of potential Essential Patent Claims by incorporation or by reference.

Note: **WG** includes Working Groups, Task Groups, and other standards-developing committees with a PAR approved by the IEEE-SA Standards Board.



Participants have a duty to inform the IEEE

- Participants shall inform the IEEE (or cause the IEEE to be informed) of the identity of each holder of any potential Essential Patent Claims of which they are personally aware if the claims are owned or controlled by the participant or the entity the participant is from, employed by, or otherwise represents
- Participants should inform the IEEE (or cause the IEEE to be informed) of the identity of any other holders of potential Essential Patent Claims

**Early identification of holders of potential
Essential Patent Claims is encouraged**

Ways to inform IEEE

- **Cause an LOA to be submitted to the IEEE-SA (patcom@ieee.org); or**
- **Provide the chair of this group with the identity of the holder(s) of any and all such claims as soon as possible; or**
- **Speak up now and respond to this Call for Potentially Essential Patents**

If anyone in this meeting is personally aware of the holder of any patent claims that are potentially essential to implementation of the proposed standard(s) under consideration by this group and that are not already the subject of an Accepted Letter of Assurance, please respond at this time by providing relevant information to the WG Chair

Other guidelines for IEEE WG meetings

- All IEEE-SA standards meetings shall be conducted in compliance with all applicable laws, including antitrust and competition laws.
 - Don't discuss the interpretation, validity, or essentiality of patents/patent claims.
 - Don't discuss specific license rates, terms, or conditions.
 - Relative costs of different technical approaches that include relative costs of patent licensing terms may be discussed in standards development meetings.
 - Technical considerations remain the primary focus
 - Don't discuss or engage in the fixing of product prices, allocation of customers, or division of sales markets.
 - Don't discuss the status or substance of ongoing or threatened litigation.
 - Don't be silent if inappropriate topics are discussed ... do formally object.

For more details, see *IEEE-SA Standards Board Operations Manual*, clause 5.3.10 and *Antitrust and Competition Policy: What You Need to Know* at <http://standards.ieee.org/develop/policies/antitrust.pdf>

Patent-related information

The patent policy and the procedures used to execute that policy are documented in the:

- ***IEEE-SA Standards Board Bylaws***
(<http://standards.ieee.org/develop/policies/bylaws/sect6-7.html#6>)
- ***IEEE-SA Standards Board Operations Manual***
(<http://standards.ieee.org/develop/policies/opman/sect6.html#6.3>)

Material about the patent policy is available at
<http://standards.ieee.org/about/sasb/patcom/materials.html>

**If you have questions, contact the IEEE-SA
Standards Board Patent Committee
Administrator at patcom@ieee.org**

Participation in IEEE 802 Meetings

Participation in any IEEE 802 meeting (Sponsor, Sponsor subgroup, Working Group, Working Group subgroup, etc.) is on an individual basis

- **Participants in the IEEE standards development individual process shall act based on their qualifications and experience. (https://standards.ieee.org/develop/policies/bylaws/sb_bylaws.pdf section 5.2.1)**
- **IEEE 802 Working Group membership is by individual; “Working Group members shall participate in the consensus process in a manner consistent with their professional expert opinion as individuals, and not as organizational representatives”. (subclause 4.2.1 “Establishment”, of the IEEE 802 LMSC Working Group Policies and Procedures)**
- **Participants have an obligation to act and vote as an individual and not under the direction of any other individual or group. A Participant’s obligation to act and vote as an individual applies in all cases, regardless of any external commitments, agreements, contracts, or orders.**
- **Participants shall not direct the actions or votes of any other member of an IEEE 802 Working Group or retaliate against any other member for their actions or votes within IEEE 802 Working Group meetings, see https://standards.ieee.org/develop/policies/bylaws/sb_bylaws.pdf section 5.2.1.3 and the IEEE 802 LMSC Working Group Policies and Procedures, subclause 3.4.1 “Chair”, list item x.**

By participating in IEEE 802 meetings, you accept these requirements. If you do not agree to these policies then you shall not participate.

(Latest revision of IEEE 802 LMSC Working Group Policies and Procedures: <http://www.ieee802.org/devdocs.shtml>)

Overview of IEEE 802.3 Standards Process (1/5)- Study Group Phase

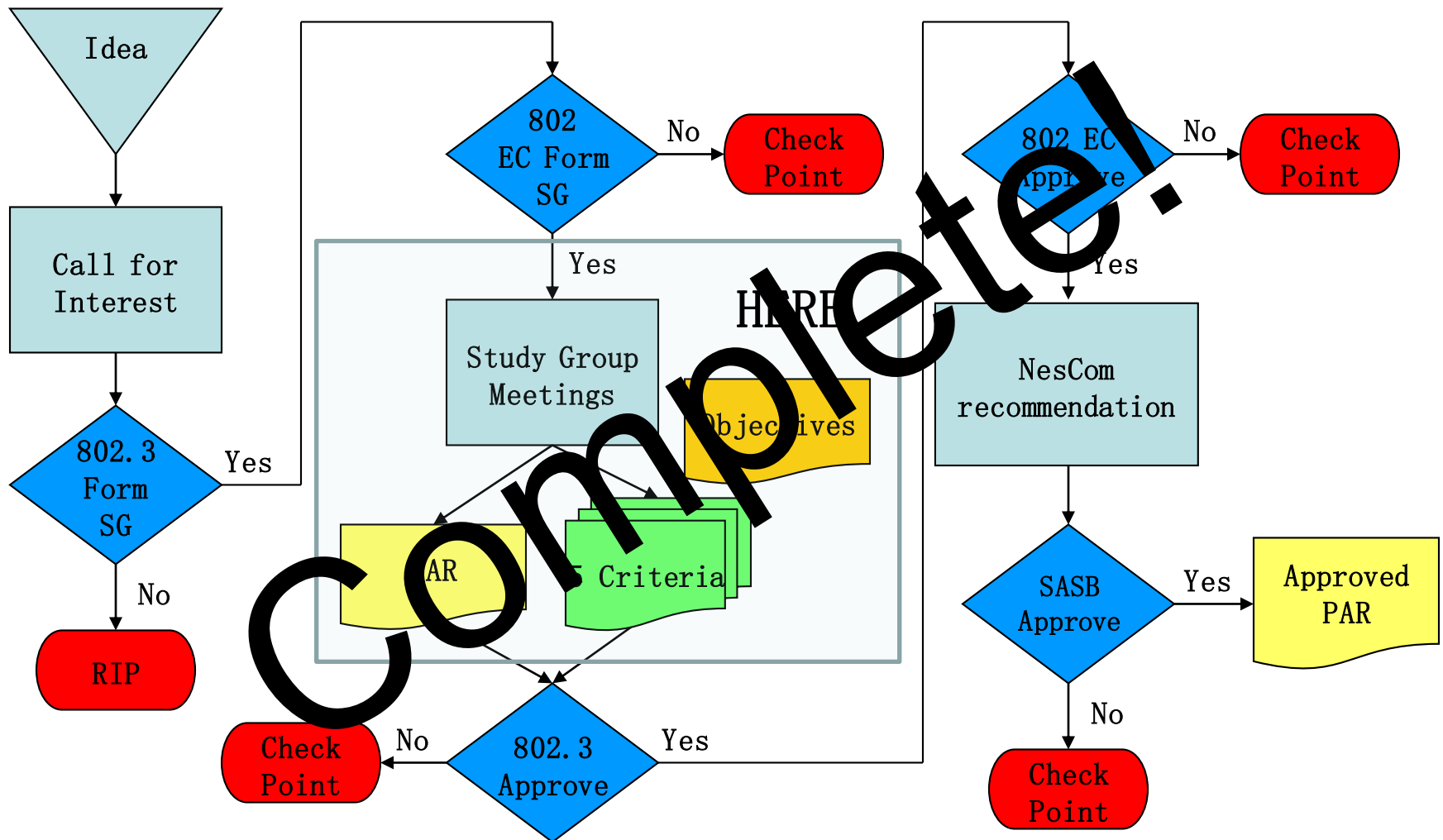

Note: At "Check Point", either the activity is ended, or there may be various options that would allow reconsideration of the approval.

Overview of IEEE 802.3 Standards Process (2/5) – Task Force Comment Phase

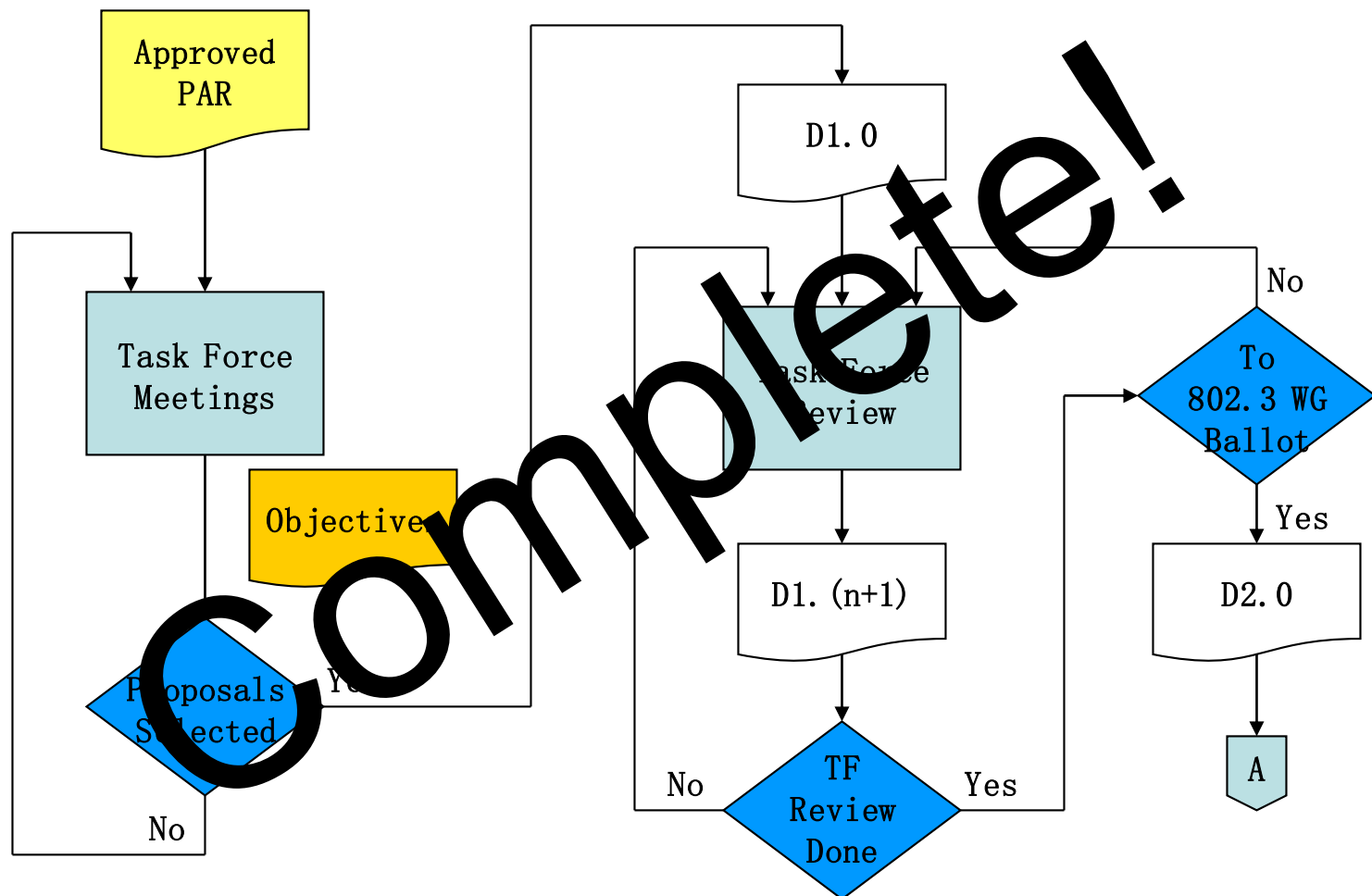

Complete!

Overview of IEEE 802.3 Standards Process (3/5) – Working Group Ballot Phase

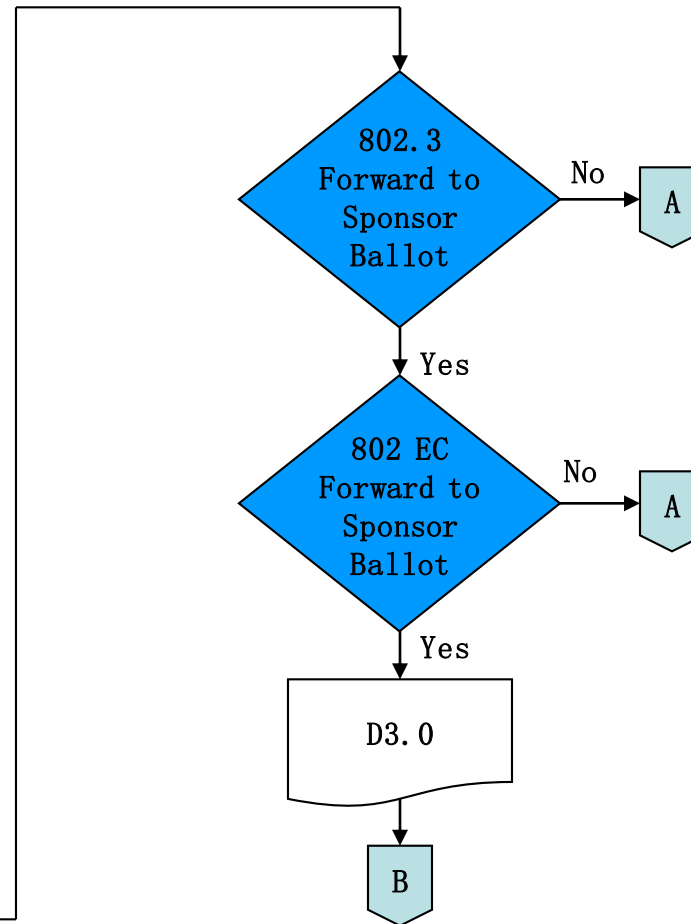
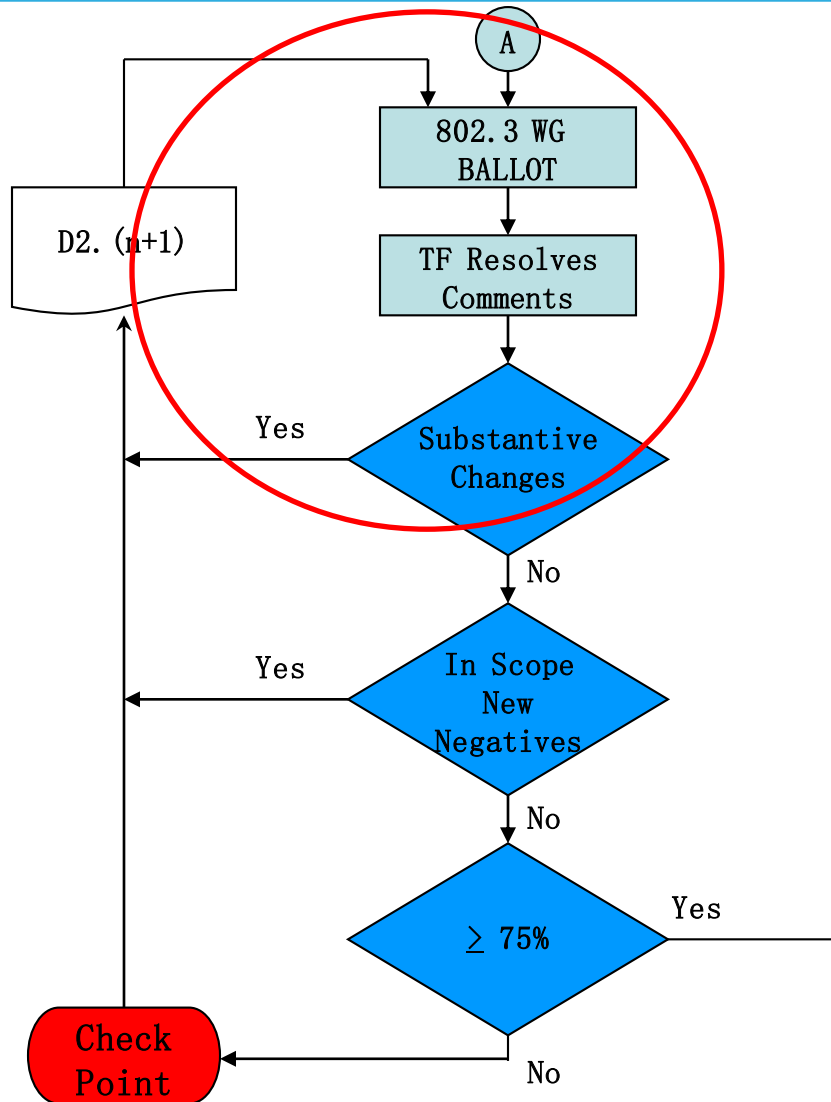

Notes: At "Check Point", either the activity is ended, or there may be various options that would allow reconsideration of the approval.

See 802.3 Operating Rules 7.1.4 and listed references for complete description

Overview of IEEE 802.3 Standards Process (4/5)- Sponsor Ballot Phase

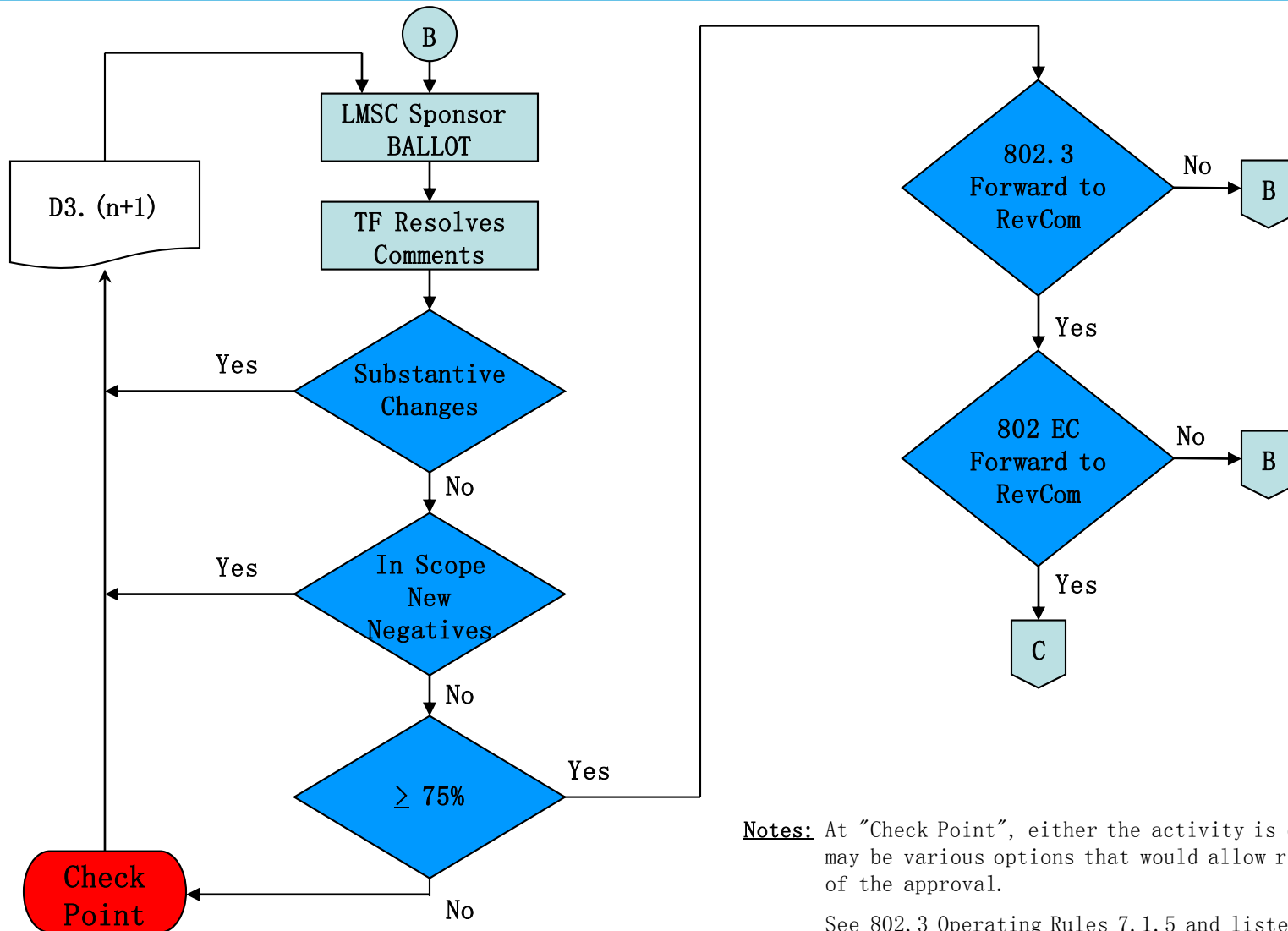

Notes: At "Check Point", either the activity is ended, or there may be various options that would allow reconsideration of the approval.

See 802.3 Operating Rules 7.1.5 and listed references for complete description

Overview of IEEE 802.3 Standards Process (5/5) – Final Approvals / Standard Release

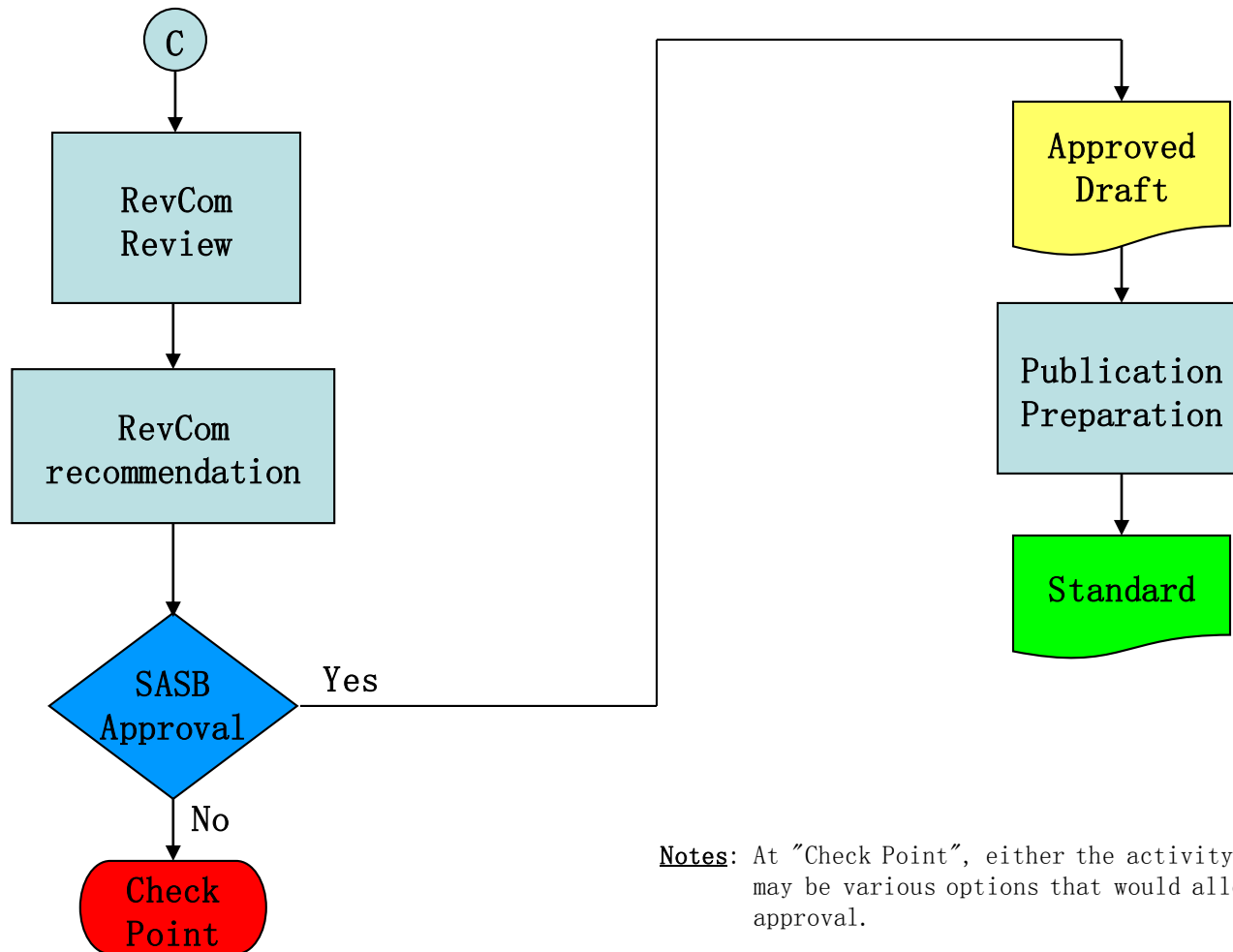

Notes: At "Check Point", either the activity is ended, or there may be various options that would allow resubmission for approval.

Liaisons and Communications

- None.

Action Items

- None.

IEEE P802.3.2 (IEEE 802.3cf) YANG Data Model Definitions Task Force Approved Project Documents

- PAR
 - http://www.ieee802.org/3/cf/IEEE_P802d3d2_220916_PAR.pdf
- Approved CSD
 - <http://www.ieee802.org/3/cf/ec-16-0142-00-ACSD-802-3cf.pdf>
- Approved Objectives
 - http://www.ieee802.org/3/cf/YANG_SG_objectives_v1.6.pdf
- Draft Timeline
 - http://www.ieee802.org/3/cf/draft_timeline_0317.pdf
- GitHub Page for draft modules
 - <https://github.com/YangModels/yang/tree/master/standard/ieee/802.3/draft>

IEEE P802.3.2 (IEEE 802.3cf) YANG Data Model Definitions Task Force Approved Project Documents

Define YANG Models based on IEEE Std 802.3-2015 for:

- Selected MAC/RS and PHYs
- Multi Point Control Protocol (MPCP)
- DTE Power via medium dependent Interface (MDI)
- Operations, Administration, and Maintenance (OAM)

IEEE P802.3.2(.3cf) Task Force Draft Timeline

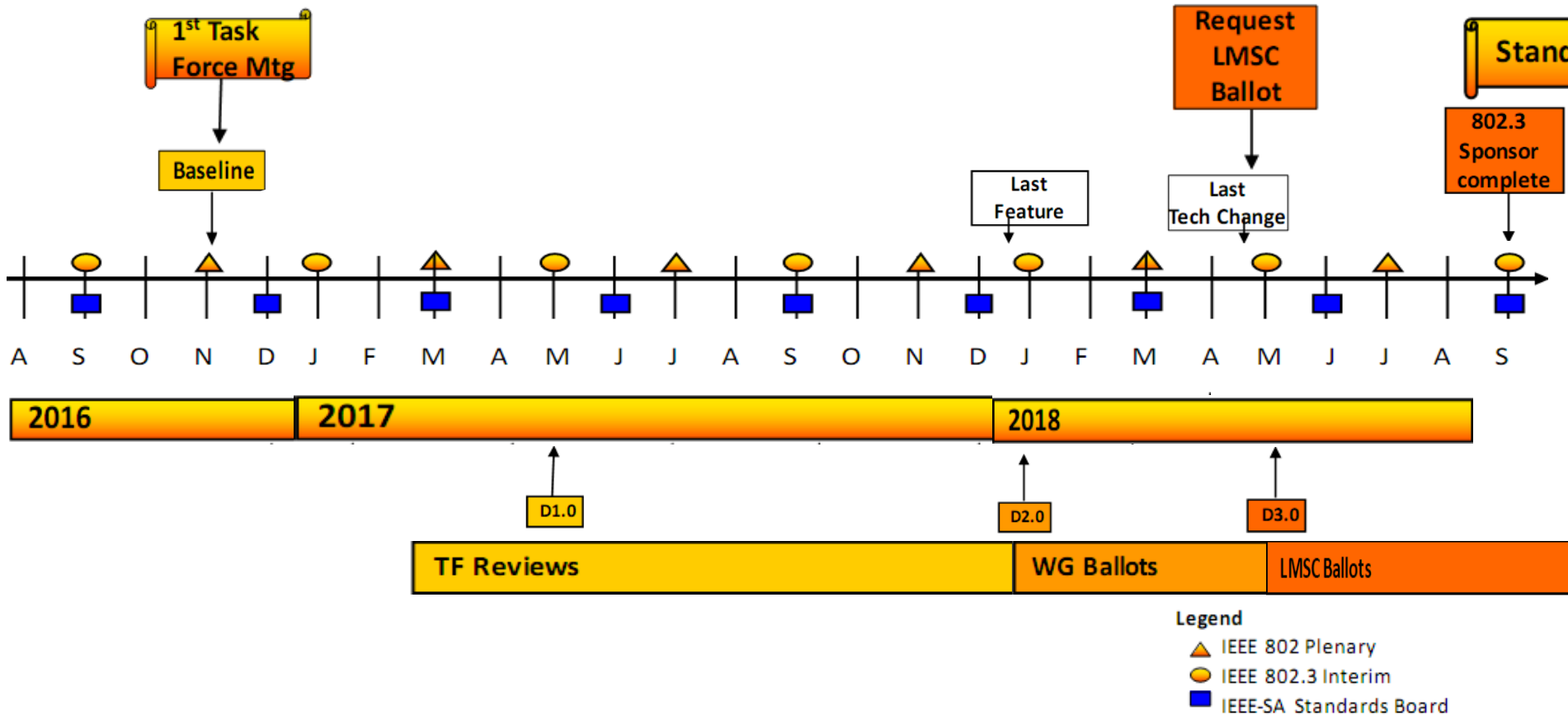

Draft proposal

Presentations

Monday morning	Time	Presenter	Affiliation	Title	Duration
21-May-18	8:00AM	Yan Zhuang	Huawei	Agenda and General Info.	00:30
	9:30AM	Marek Hajduczenia	Charter	Comments resolution	02:15
	11:45AM	Open Discussions& Straw Polls& Motions			00:15

Note - Times listed are subject to change.

Future Meetings

- See: <http://www.ieee802.org/3/interims/index.html>
- Ad-hoc meeting plans
 - Bi-weekly meetings if needed, all topics (will cycle) – agendas will be published. 1 hr duration.
- July 2018 Plenary
 - Week of July 8, 2018 – San Diego, CA, USA
- September 2018 Interim
 - Week of September 10, 2018 -- Spokane, WA, USA
- November 2018 Plenary
 - Week of November 12, 2018 -- Bangkok, Thailand
- Anyone interested in hosting a interim meeting contact me or the IEEE 802.3 Executive Secretary [Steve Carlson](#).

Thank You!