The Impact of Upstream Power Back-off on EFM Bit Rates

Krista S. Jacobsen
Texas Instruments

Outline

- ◆ Review of EFM goals and constraints
- ◆ Review of near-far FEXT problem
- ◆ Upstream power back-off
 - Methods
 - Performance
 - ◆ Achievable upstream bit rates at 750m
- ◆ What does it mean for EFM?

EFM Goals

- ◆ Support of 10Mbps symmetrical at a reach of at least 750m of 26AWG line
- ◆ Ensure spectral compatibility with existing services
 - Of particular concern (due to high data rates) is standardized VDSL
 - ◆ 997 - Europe
 - ◆ 998 - North America, and alternate plan for Europe
 - EFM PHY must be spectrally compatible with at least one of these frequency plans (probably 998)
 - ◆ Easiest way to be spectrally compatible with 998 (997) is to use 998 (997) with appropriate PSDs
 - ◆ Not the same as assuming VDSL...

The Near-Far FEXT Problem

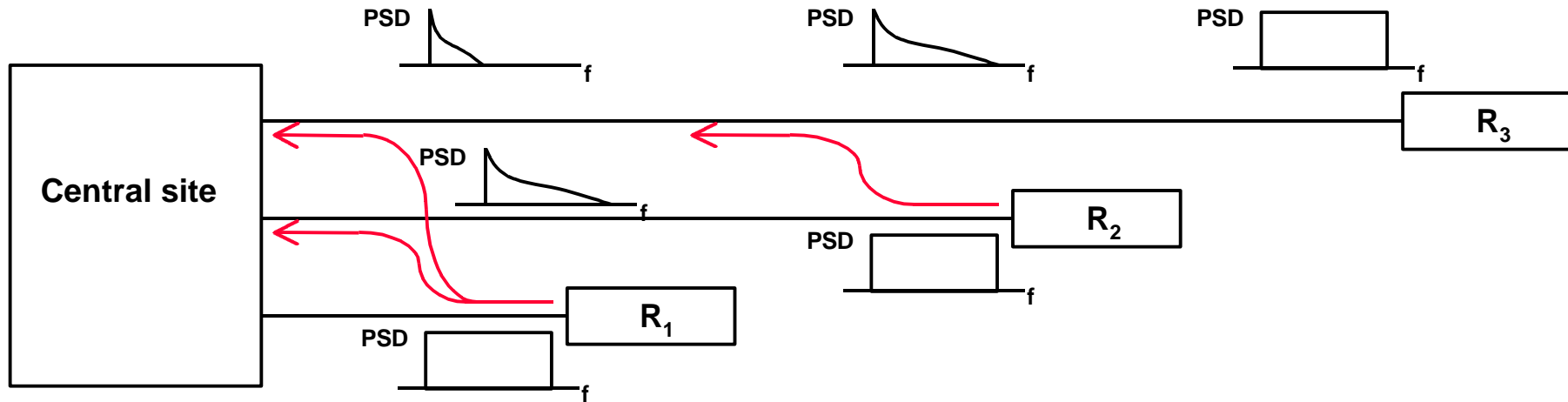

- ◆ Full-power upstream transmissions on short (near) loops result in high-level far-end crosstalk (FEXT) noise on long (far) loops
 - “Near-far FEXT”
- ◆ Upstream bit rates on long loops can be dramatically reduced

Impact of Near-Far FEXT on Rates (998)

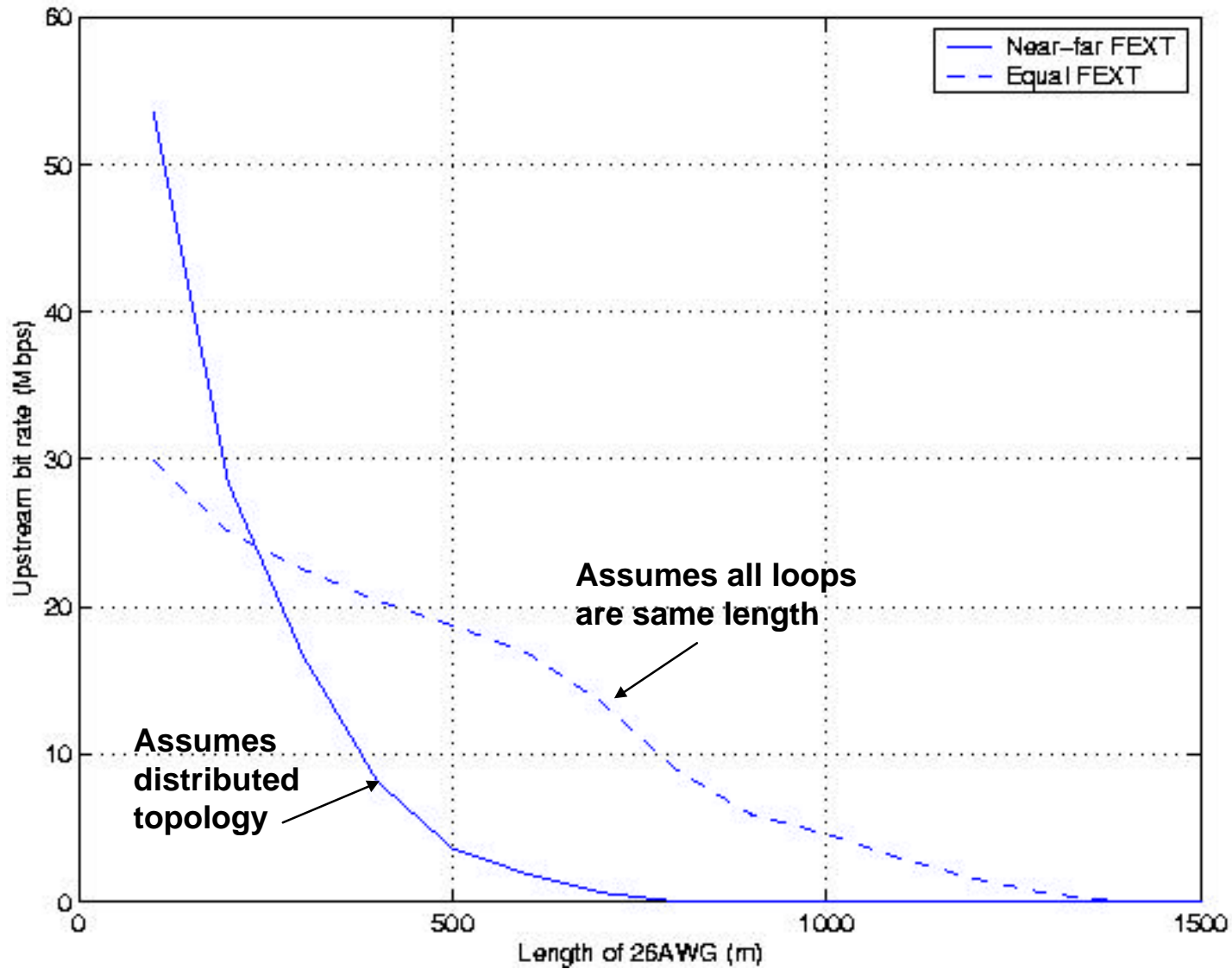

Combating the Near-Far Problem

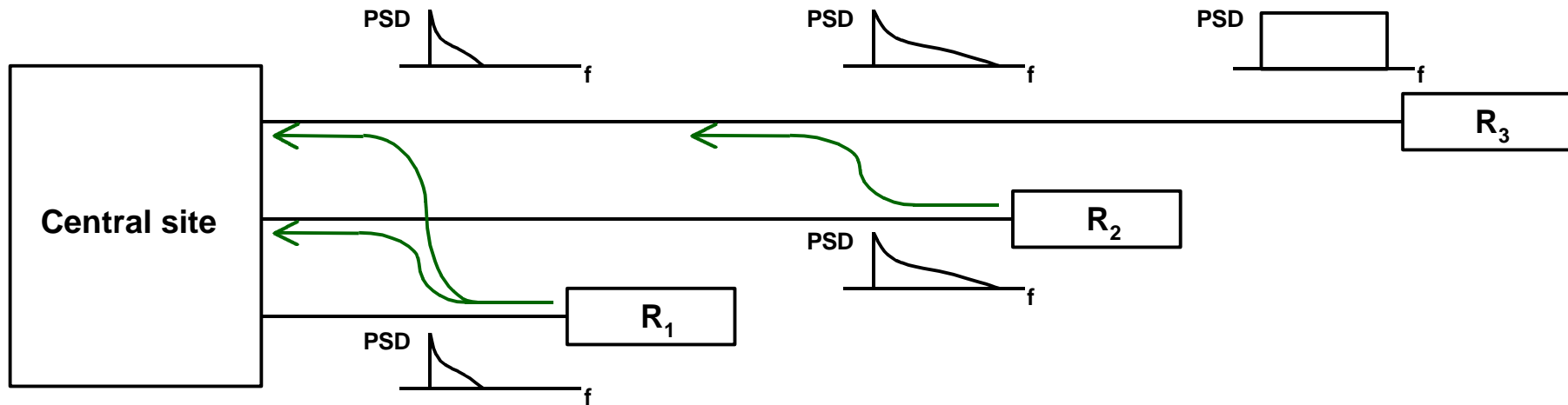

- ◆ Upstream transmitters must reduce their PSDs so the levels of FEXT they inject to shorter loops are lower
- ◆ The process of reducing the upstream PSDs is known generically as *upstream power back-off (UPBO)*

Methods of UPBO

- ◆ Many methods have been identified
 - Reference frequency method
 - Reference length method
 - Equalized-FEXT method
 - Multiple reference lengths
 - Reference noise method
- ◆ What upstream rates are achievable with each method using 998 and 997?

Simulation Loop Topology

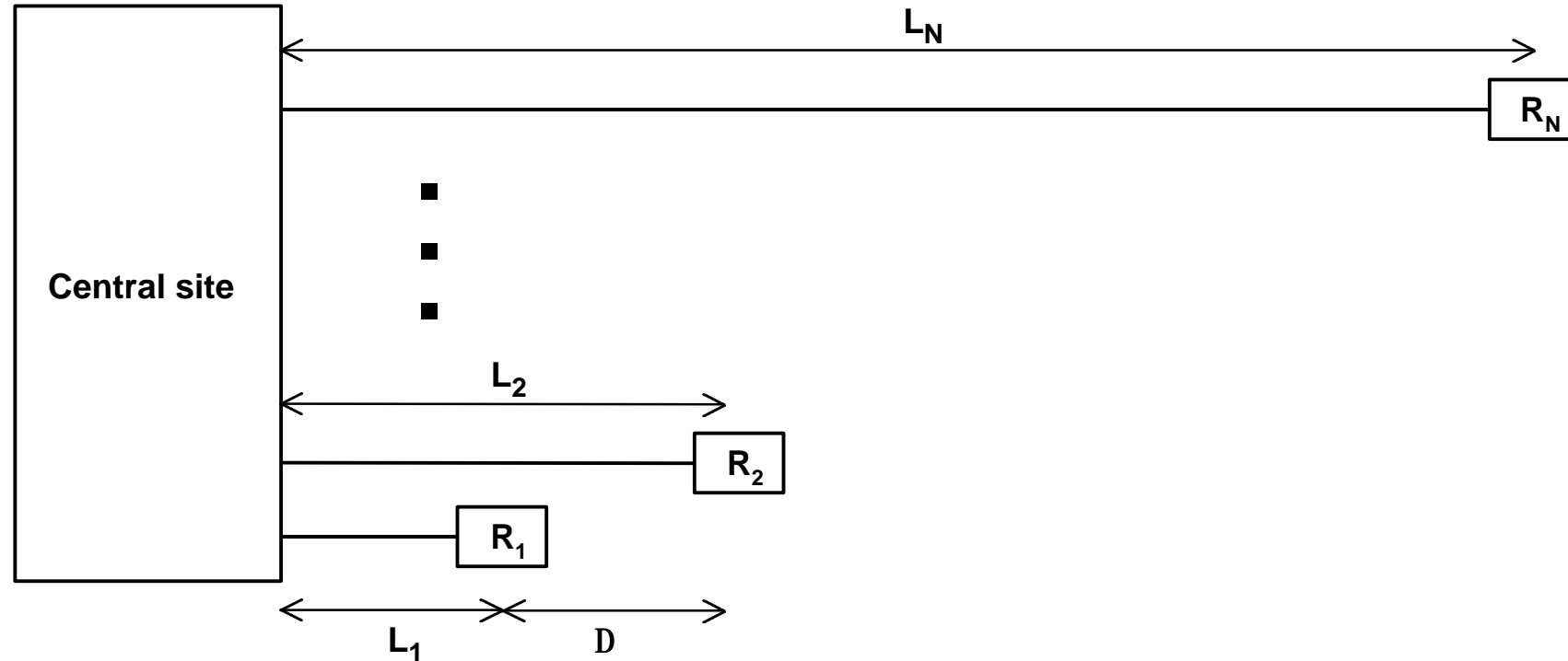

$$L_1 = 50 \text{ m}, L_N = 1500 \text{ m}$$

$$D = 50 \text{ m}$$

1 modem per length (i.e., 30 modems total)

Additional Simulation Assumptions

- ◆ Frequency plans considered:
 - 998: upstream bands from 3.75-5.2 MHz and from 8.5-12.0 MHz
 - 997: upstream bands from 3.0-5.1 MHz and from 7.05-12.0 MHz
 - **Optional band from 25-138 kHz not used**
- ◆ Maximum transmit PSD of -60 dBm/Hz
- ◆ Brick-wall filters, no excess bandwidth
 - **Results represent best-case performance**
- ◆ FSAN method of adding disturbers:
 - Raise individual FEXT contributions to 1/0.6, sum all contributions, and raise result to the 0.6
 - Avoids overly-pessimistic simulation results due to adding worst-case FEXT multiple times
- ◆ Equal-FEXT performance shown as reference
 - Represents performance that would be simulated without back-off

Reference Frequency Method

- ◆ A reference frequency is selected
- ◆ The desired received PSD at the reference frequency is determined
 - May be computed using a reference loop, such as the longest loop on which service is intended to be provided
- ◆ All upstream transmitters decrease their transmit PSDs in a frequency-independent manner so that the PSD received at the central site is the desired value at the reference frequency
- ◆ Resulting bit rates depend on choices of reference frequency and desired received PSD

Reference Frequency Method

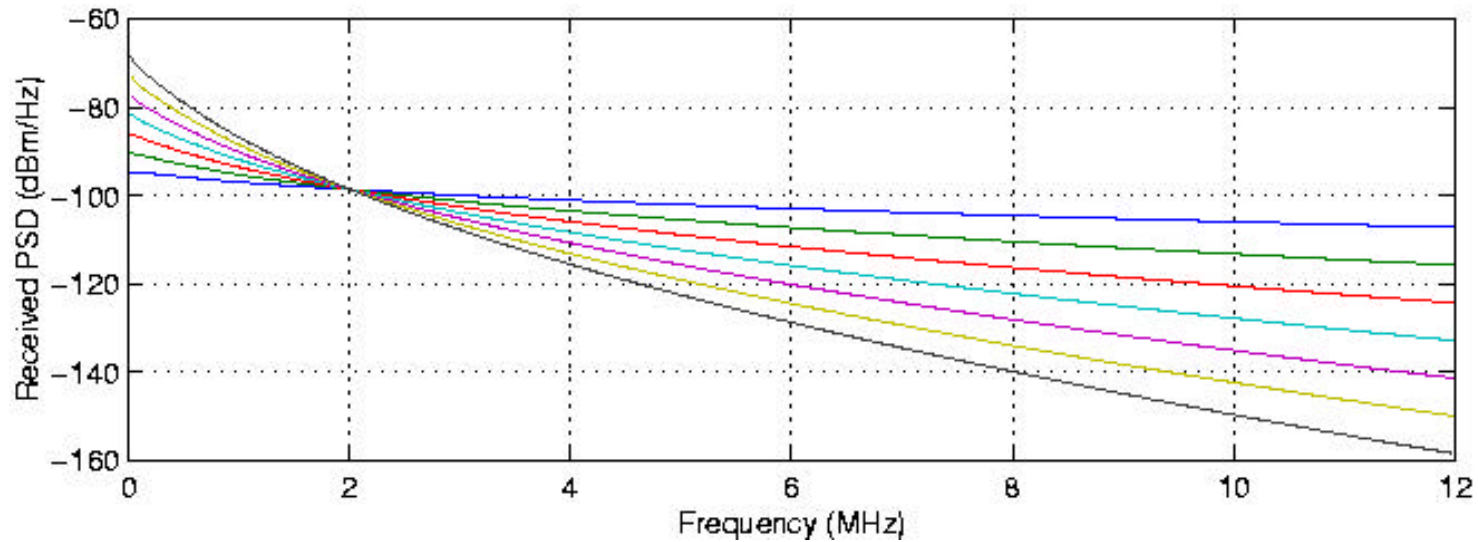
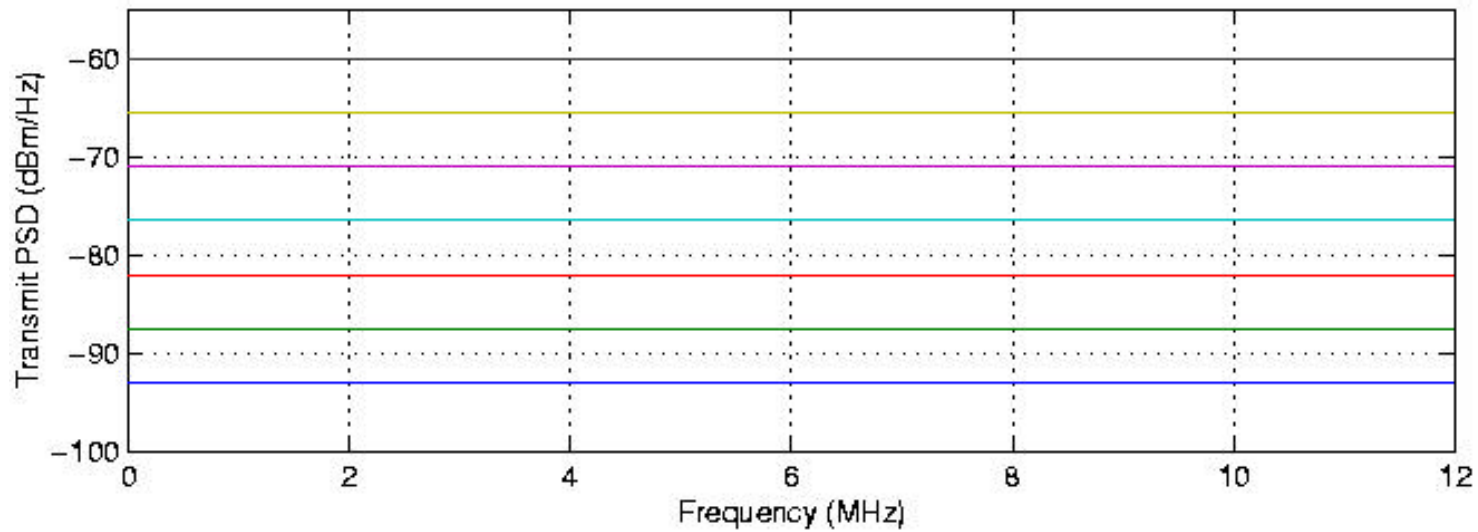

Reference Frequency Method - 998

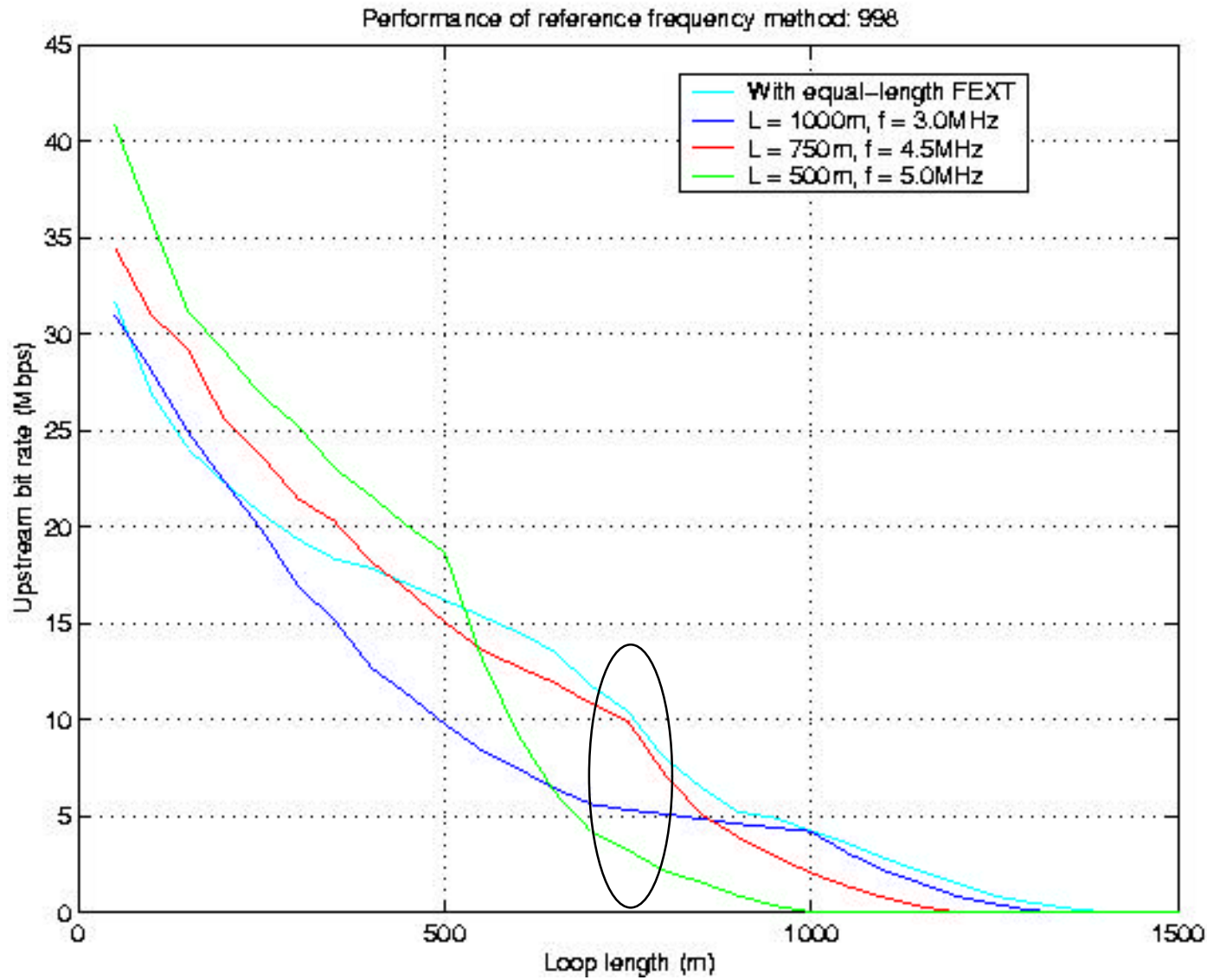

Reference Frequency Method - 997

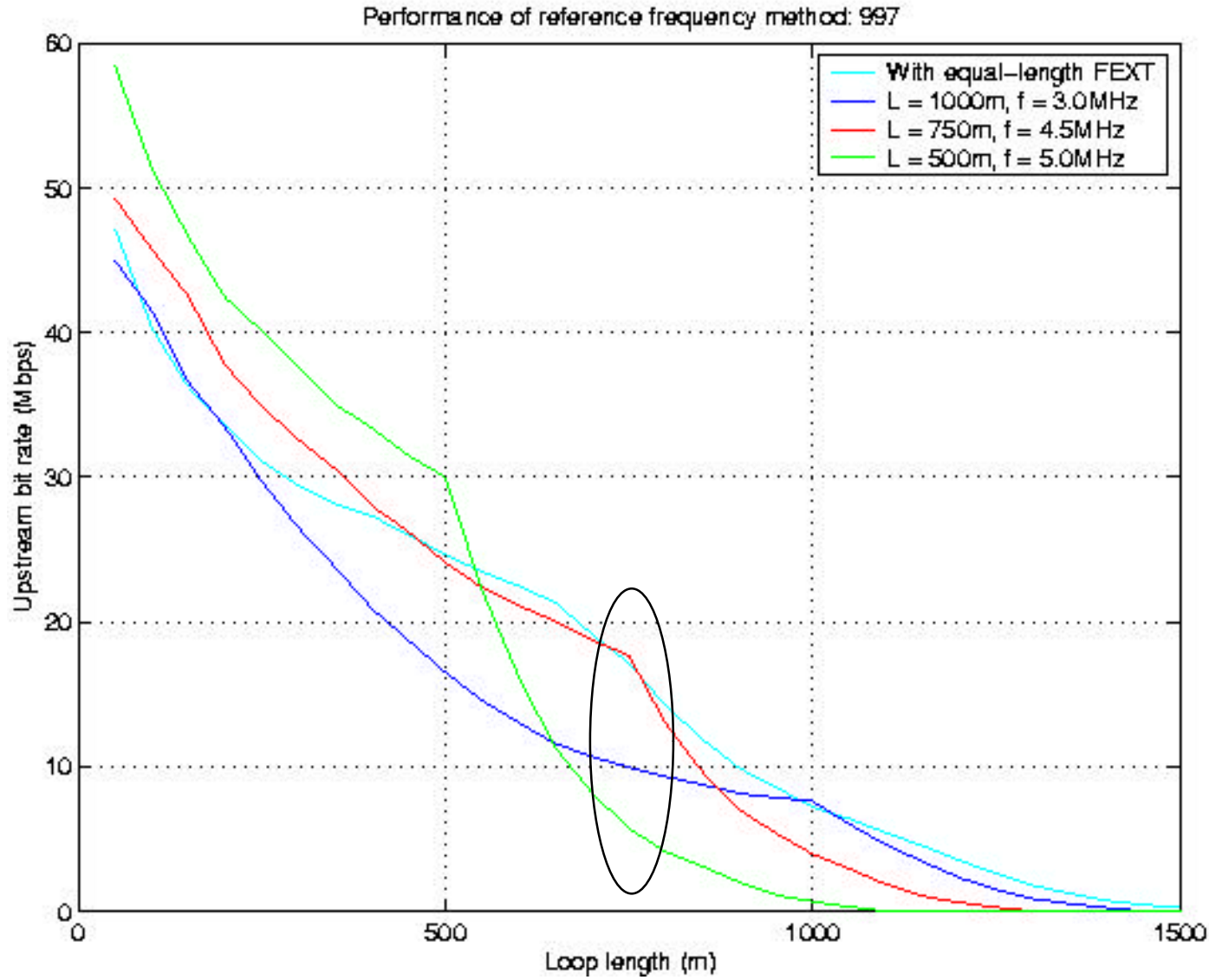

Reference Length Method

- ◆ A reference length is selected based on service provisioning requirements
- ◆ The desired received PSD profile, as a function of frequency, is defined as the PSD that would be received if some known PSD were transmitted on a loop of the reference length
- ◆ All upstream transmitters set their PSDs such that the desired received PSD profile is received at the central site on all loops

Reference Length Method

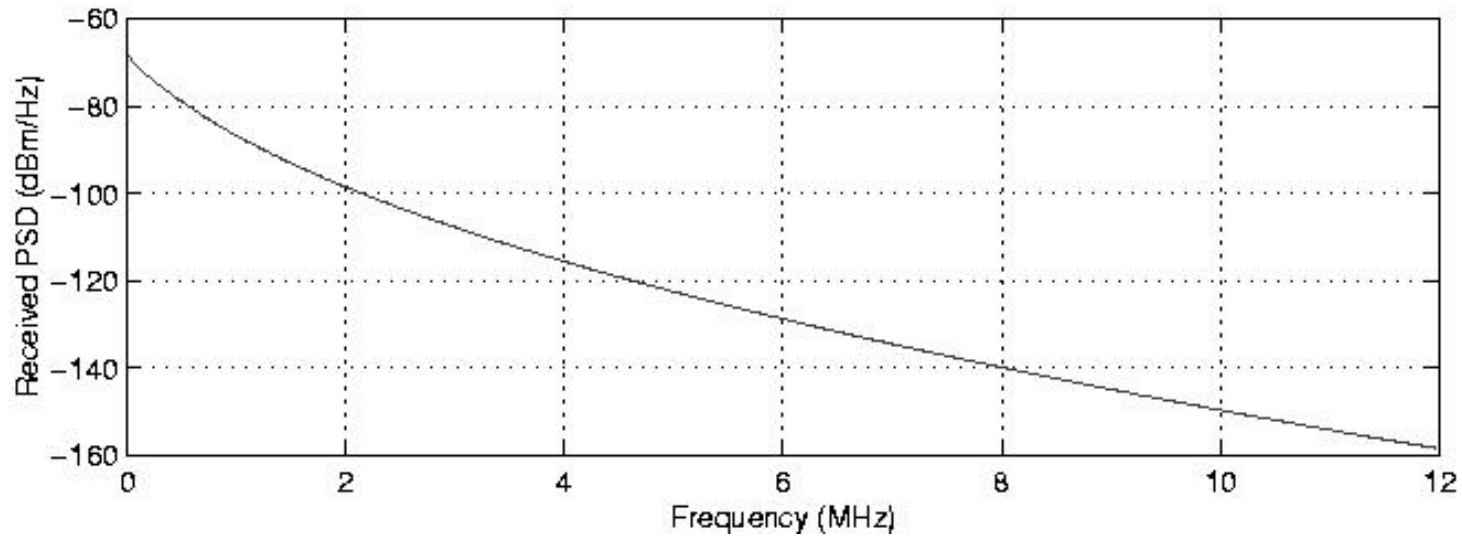
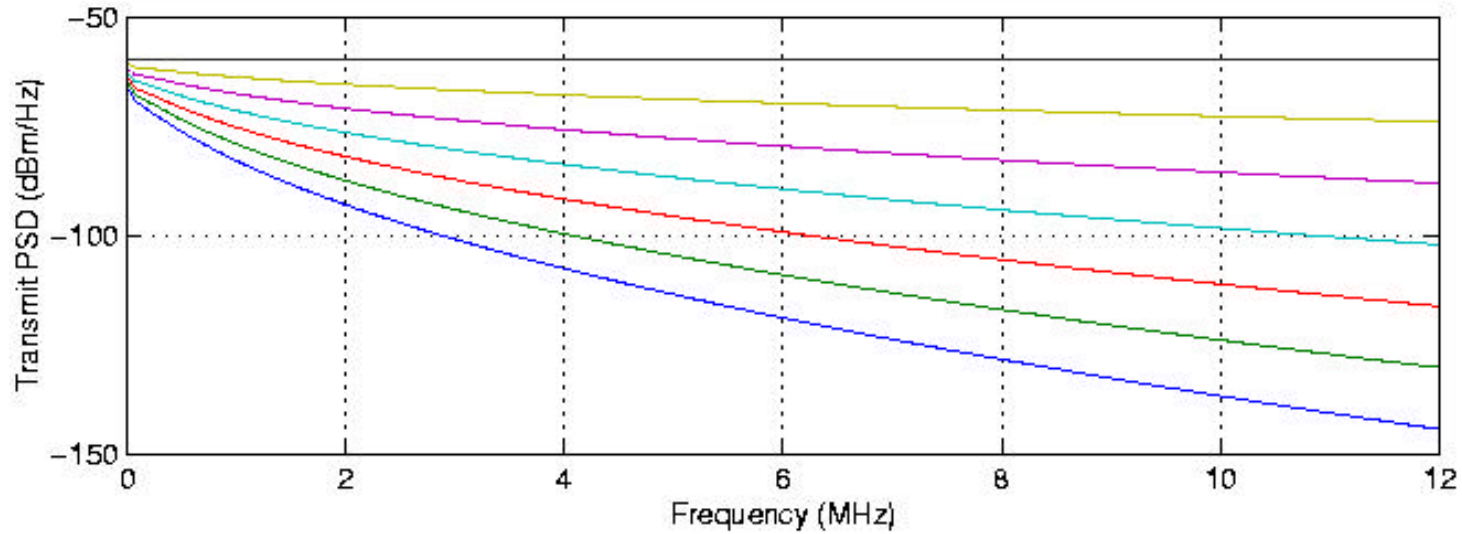

Reference Length Method - 998

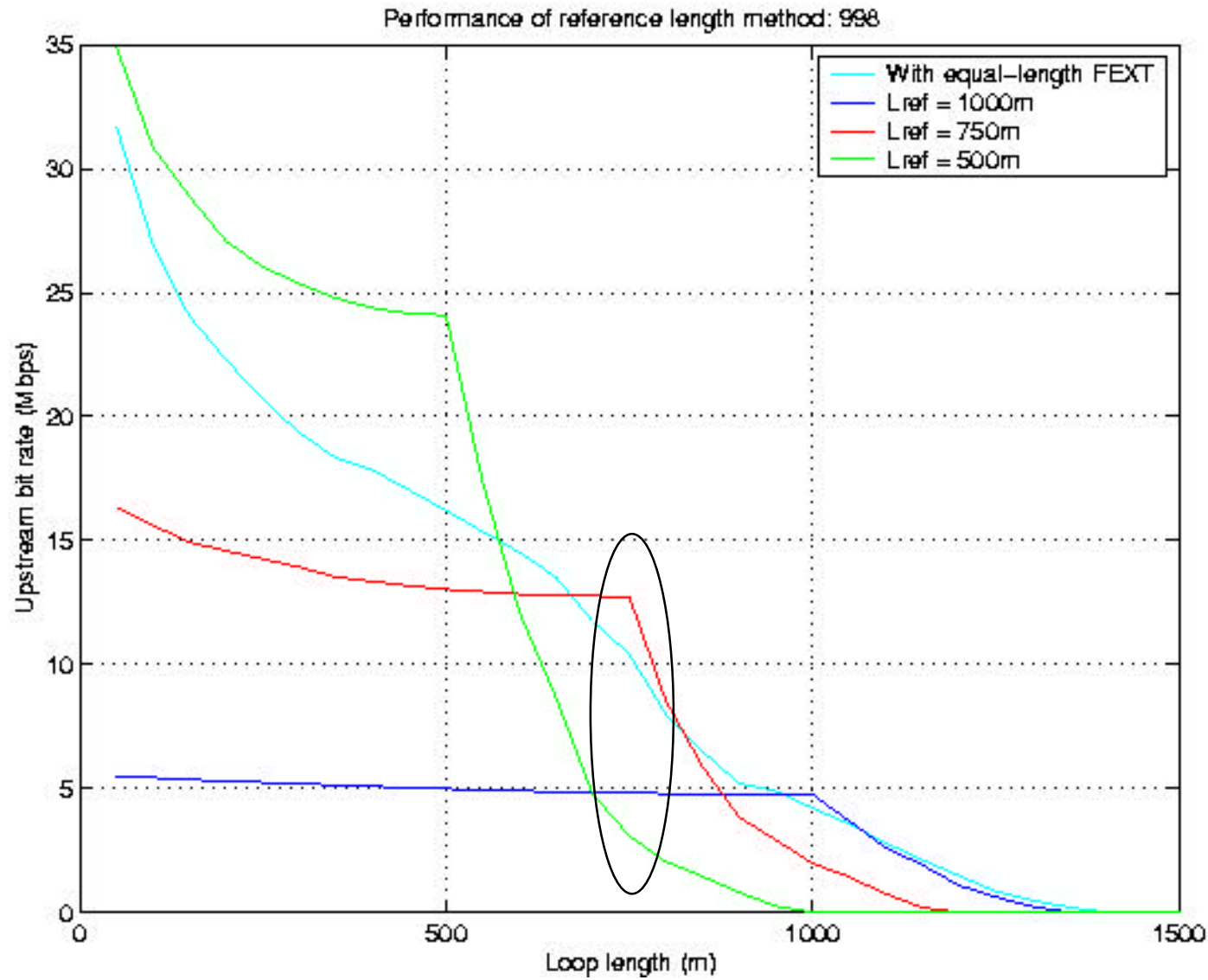

Reference Length Method - 997

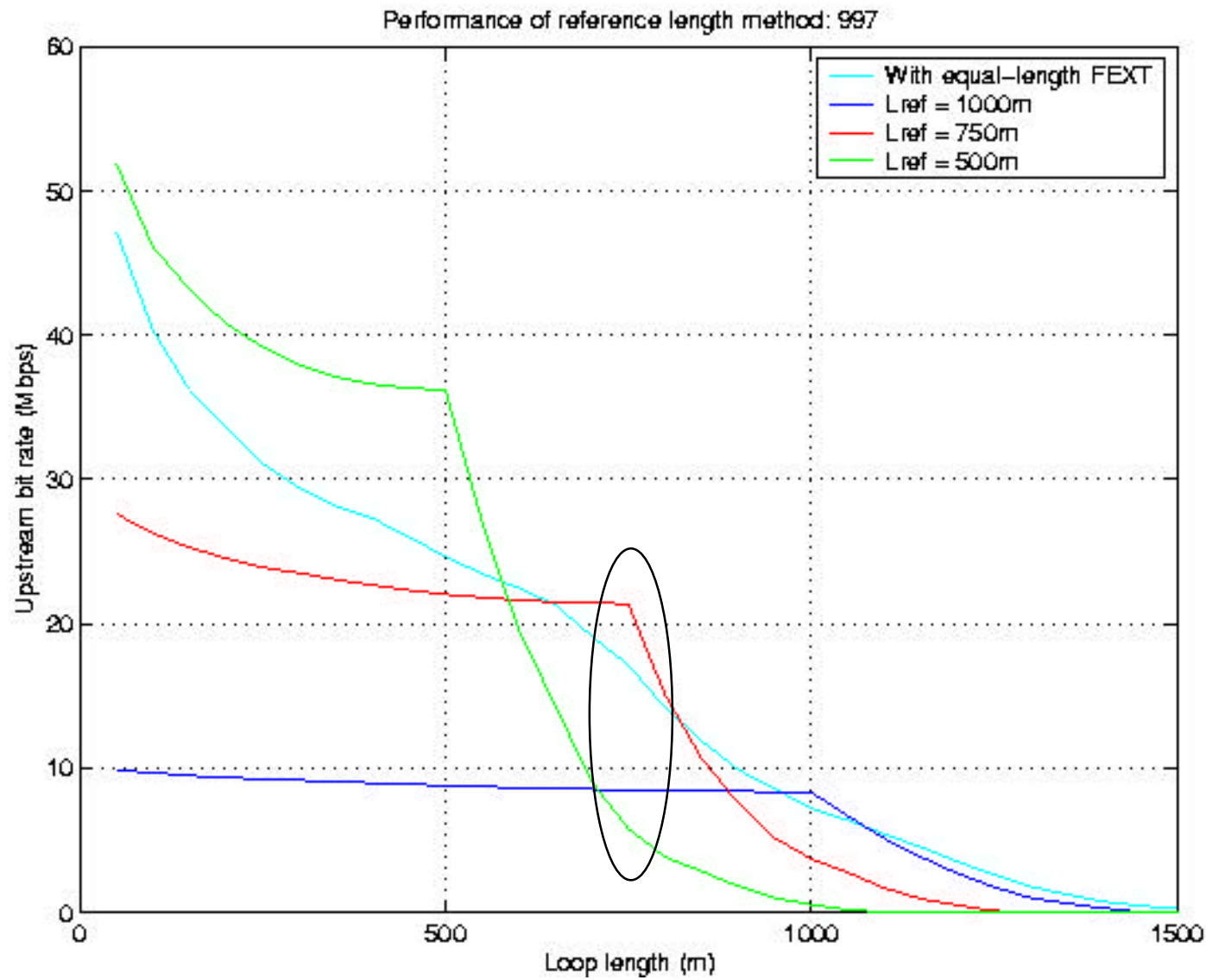

Equalized-FEXT Method

- ◆ Upstream transmit PSDs are adjusted so that FEXT at each upstream receiver is approximately the same
- ◆ A reference length is selected based on service provisioning requirements
- ◆ Upstream PSDs are set such that the FEXT at any other receiver appears to be caused by a line of the reference length
- ◆ Similar to reference length method, but equalized-FEXT allows higher transmit PSDs at lower frequencies

Equalized-FEXT Method

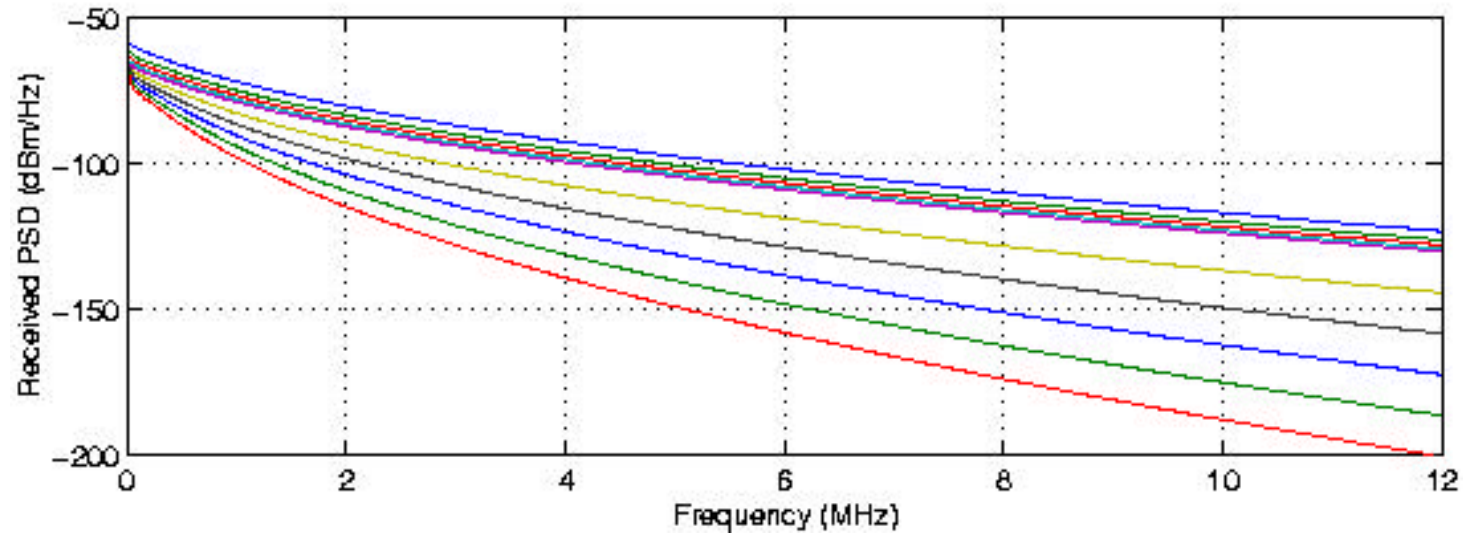
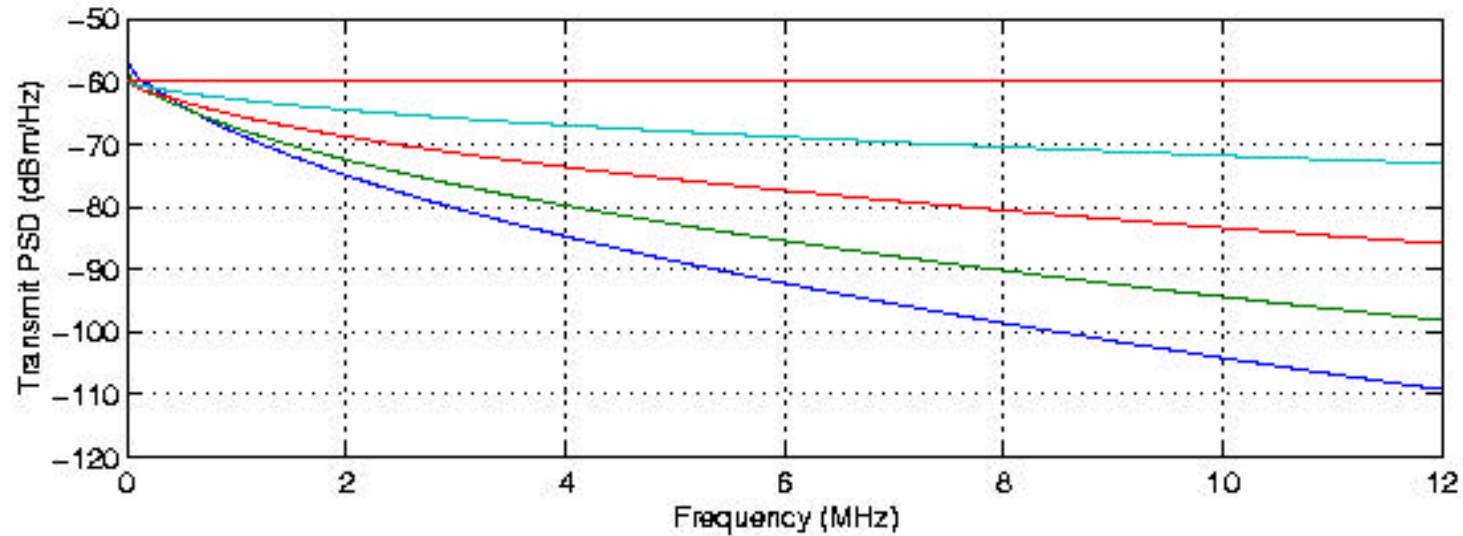

Equalized-FEXT Method - 998

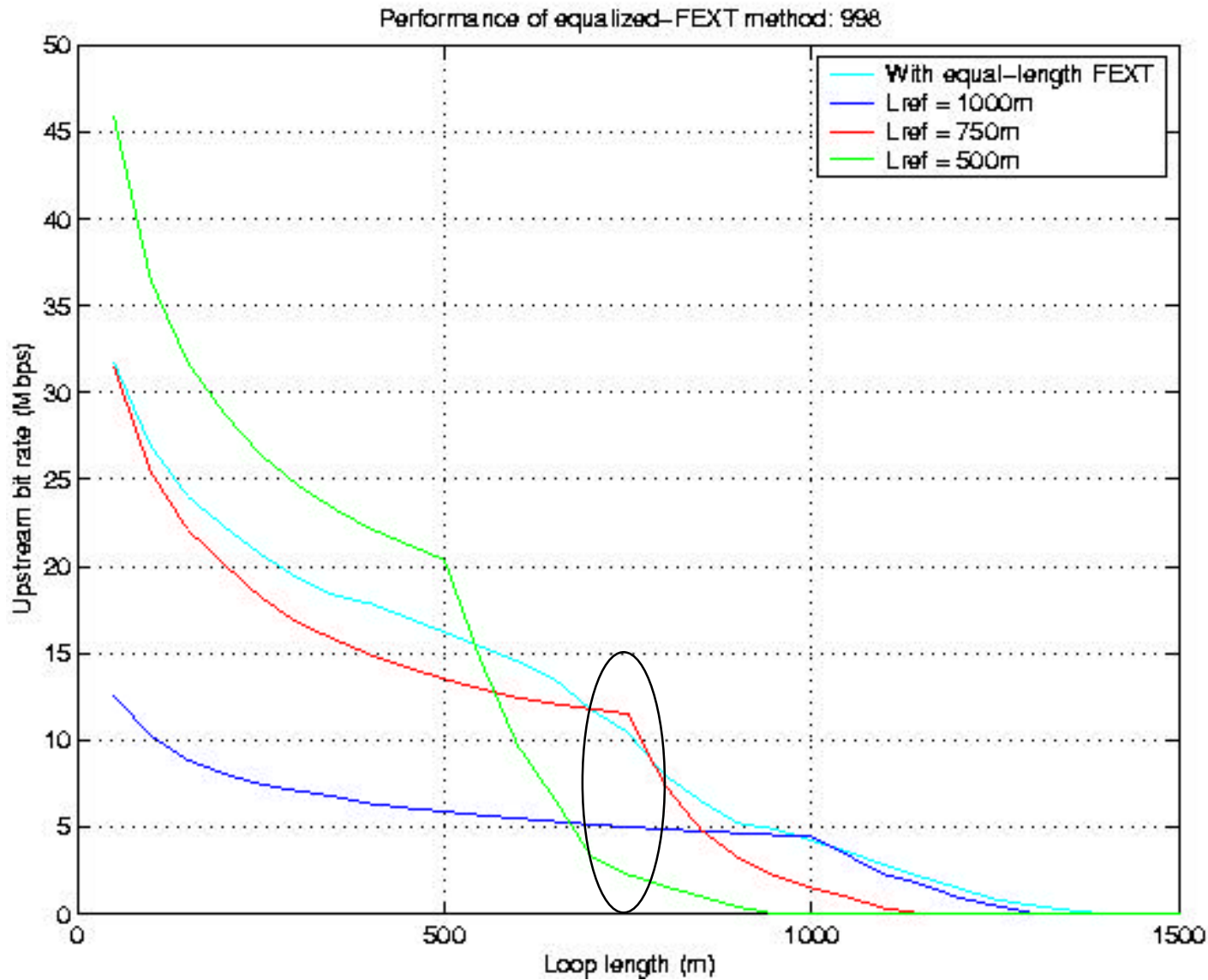

Equalized-FEXT Method - 997

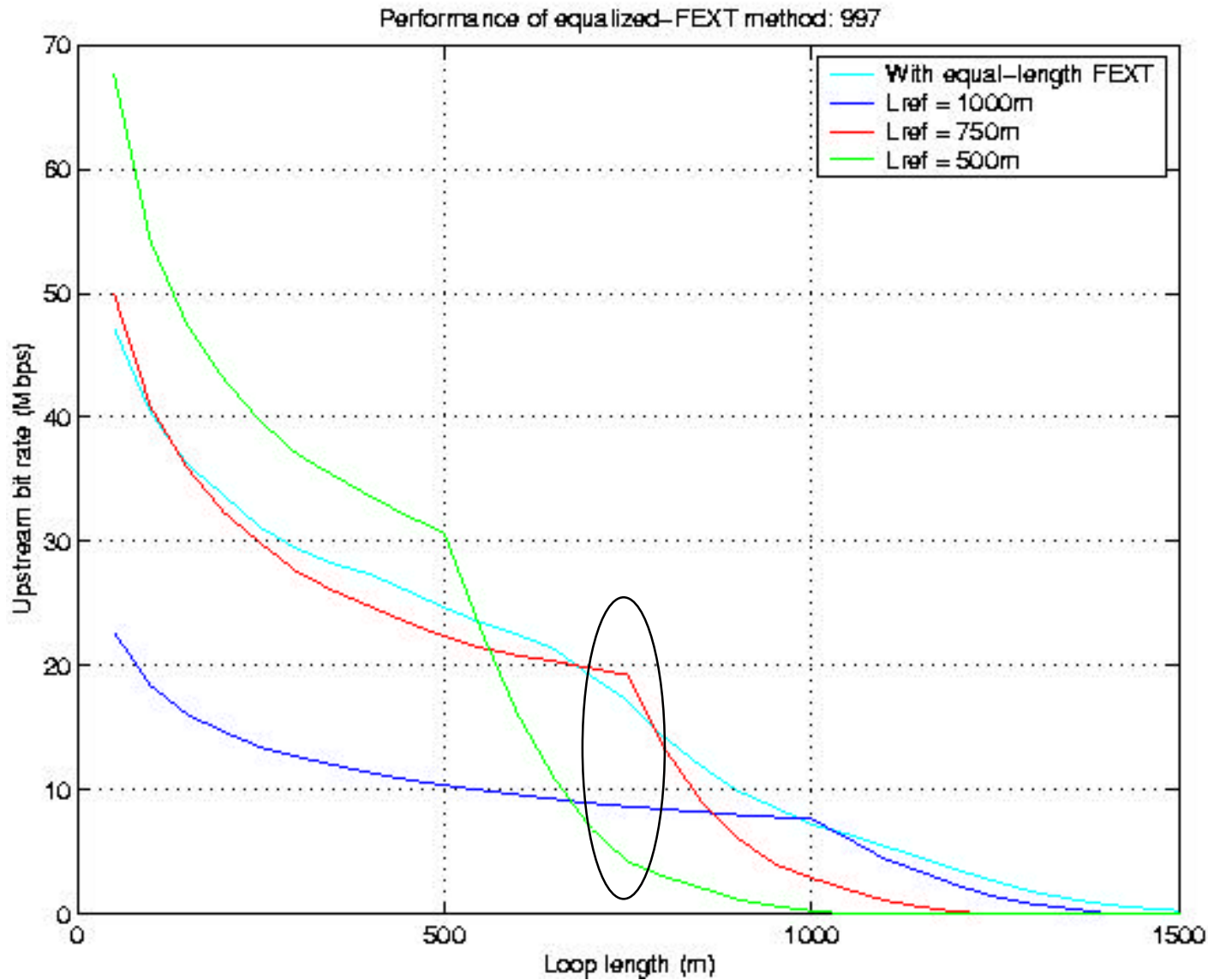

Use of Multiple Reference Lengths

- ◆ Reference length and equalized-FEXT methods can benefit from the use of more than one reference length to improve performance
- ◆ Can take advantage of the knowledge that long loops cannot support transmission at high frequencies due to loop attenuation
 - Select longer reference lengths for lower frequencies, shorter reference lengths for higher frequencies
 - Higher PSD levels at higher frequencies on shorter loops won't affect performance on long lines because those frequencies are too attenuated to support data

Reference Noise Method

- ◆ Upstream PSDs are reduced such that the level of FEXT they inject to other lines is at the same level as an assumed noise profile
- ◆ A very cool property:
 - The degradation to upstream upstream SNRs relative to when all the lines are of equal length and the upstream transmit PSDs are all at the maximum allowed level is less than 3dB
 - The reference noise method is the only method proven to have this property (so far...)
- ◆ Key is to get the reference noise right
 - For the upstream frequencies used in 998 or 997, dominant noise should be FEXT from like systems
 - ◆ Appropriate reference noise is likely self-FEXT

Reference Noise Method

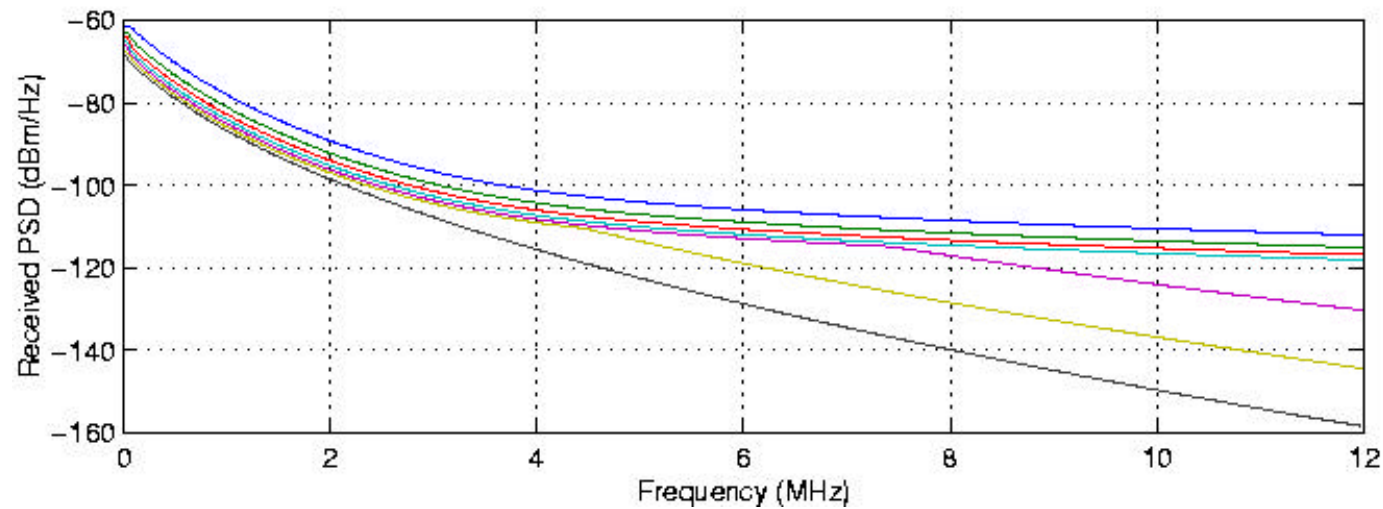
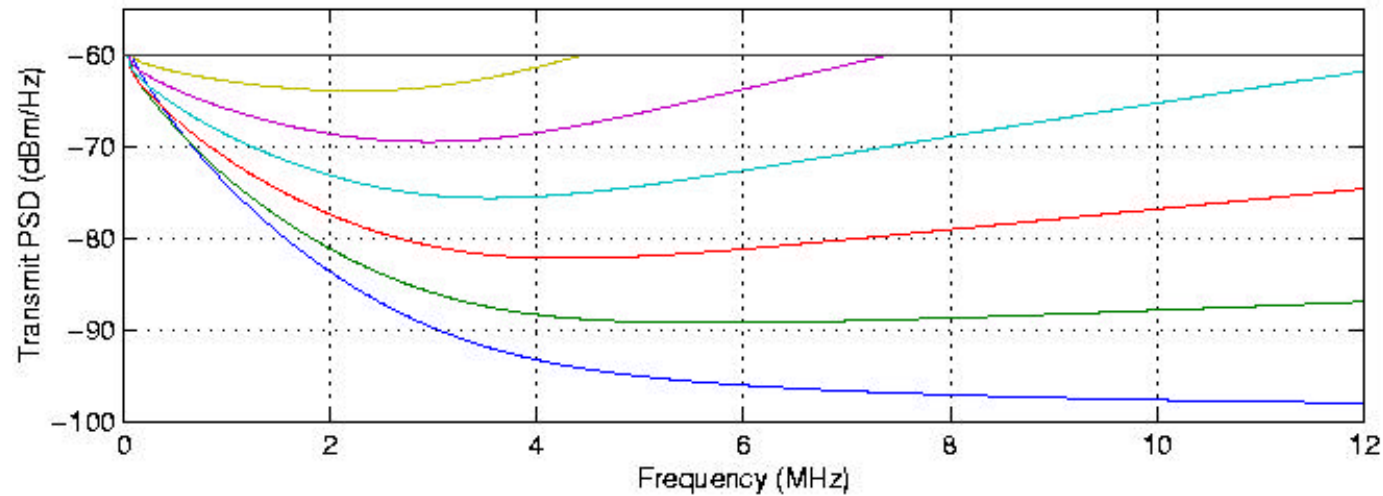

Plots assume a reference noise profile of self-FEXT

Reference Noise Method - 998

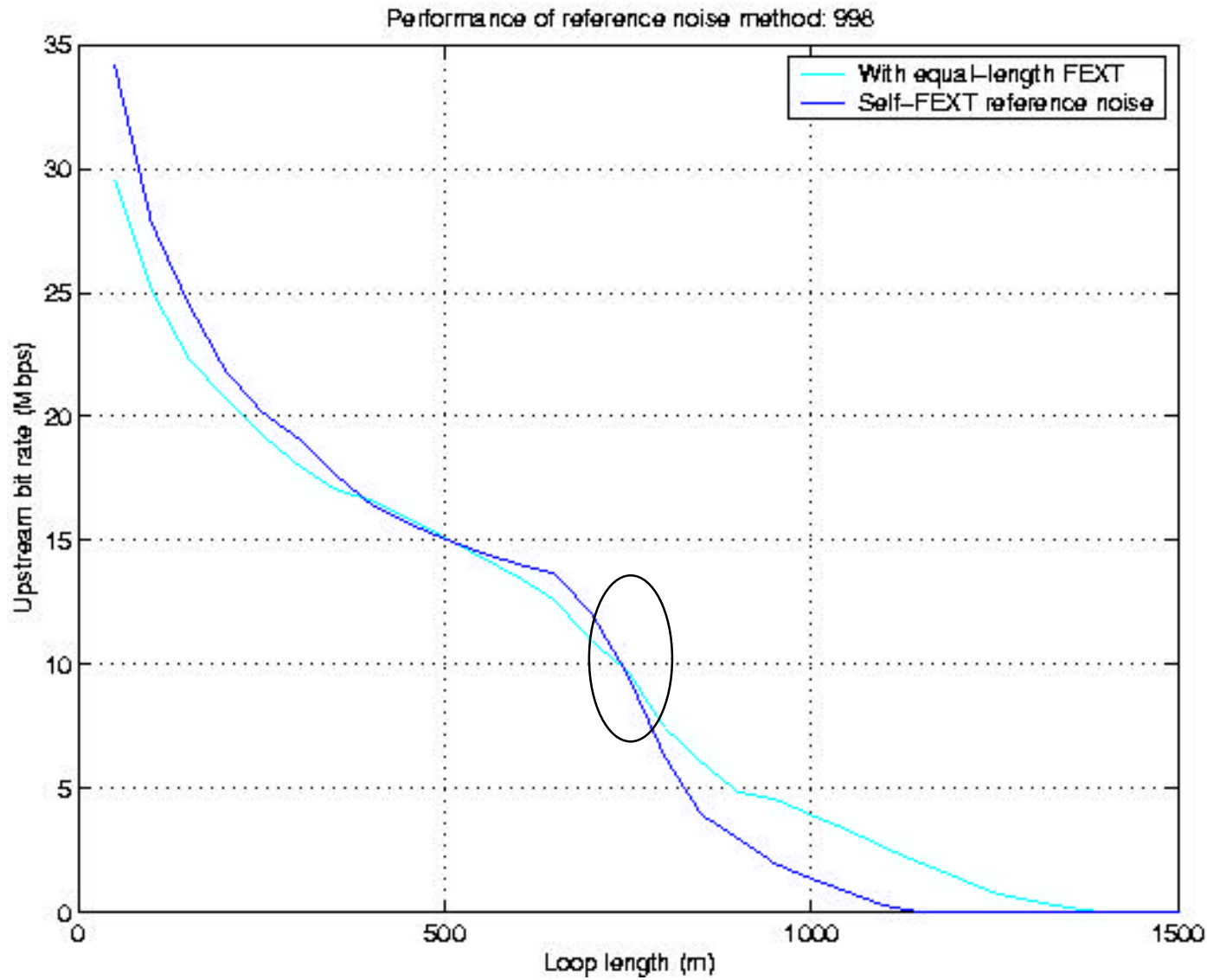

Reference Noise Method - 997

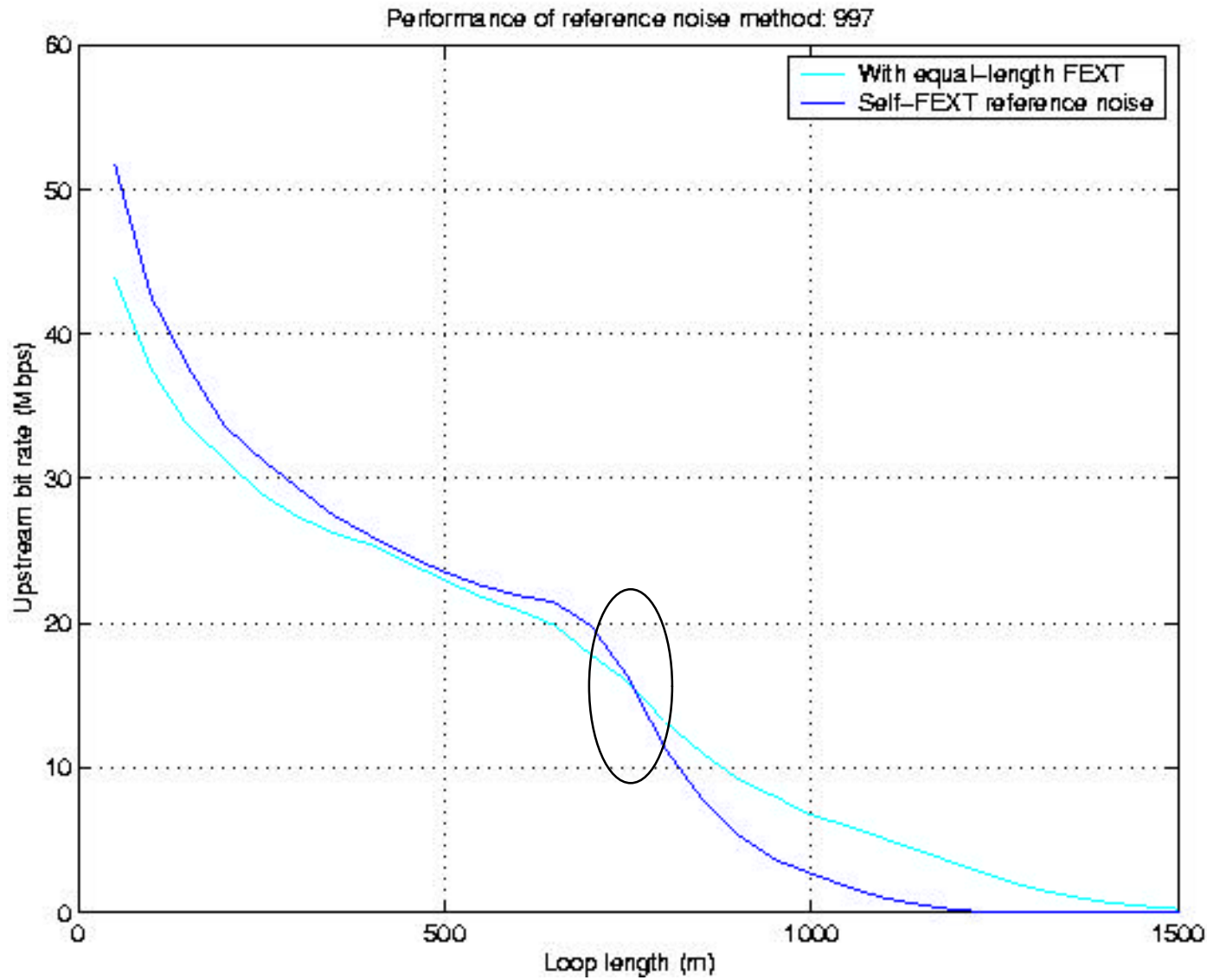

What does it mean for EFM?

- ◆ Under **optimistic** assumptions, 10Mbps is achievable at 750m with upstream power back-off
 - Reference length method seems to provide the most headroom
 - Plan 997 is better than 998
 - ◆ 997 supports 10Mbps at a longer reach, and provides more headroom at 750m
- ◆ With 998, probably need to use optional band (25-138kHz) in upstream direction to ensure 10Mbps at 750m
 - Filters, excess bandwidth will degrade upstream rates
- ◆ Equal-length FEXT simulations:
 - Are optimistic for reaches greater than reference length
 - Are accurate or slightly pessimistic at the reference length
 - May be optimistic or pessimistic for reaches below reference length, depending on choices of parameters