

An overview on high speed optical wireless/light communications

Date: 2017-07-03

Author:

Name	Company	Address	Ph one	Email
Nikola Serafimovski	pureLiFi	U.K.		nikola.serafimovski@purelifi.com
Volker Jungnickel	Fraunhofer HHI	Germany		volker.jungnickel@hhi.fraunhofer.de
Yeong Min Jang	Kookmin University	Korea		yjang@kookmin.ac.kr
John Li Qiang	Huawei	China		john.liqiang@hisilicon.com

Abstract

- **Optical wireless communications (OWC) or light Communications (LC) is applicable to a wide range of different use-cases.**
- **OWC/LC is shown to be technically feasible from both a theoretical and practical perspective, with a number of demonstration systems identified in the market.**
- **The light spectrum can be used to provide data off-loading and link aggregation capabilities in conjunction with other radio frequency technologies in an globally harmonized and license exempt spectrum.**
- **The IEEE 802.15 has two standards effort for OWC and the IEEE 802.11 has a topic interest group looking at the feasibility of introducing LC to 802.11**
 - The **802.15.7m** is primarily looking at developing the existing 802.15.7 standard for visible light communications to include optical camera communications (OCC) and low rate photo diode communications.
 - The **802.15.13** is looking at using OWC for high speed specialty wireless networks for deployment in factories and industrial scenarios
 - The **802.11 LC TIG** is looking at the feasibility of including OWC as part of the 802.11 that would serve more mass market use-cases as a complement to existing RF capabilities
- **The market size for LC is expected to be over \$75.5 billion by 2023 when across the value chain with over 550 million light bulbs installed annually.**

Wi-Fi is great, but cannot solve all problems and is a victim of its own success

– Situation

- Wi-Fi is one of the most common communication mediums in Enterprise and Home environments

– Problems

- Wi-Fi signals are difficult to confine to specific areas, which has potential security implications in some environments
- Wi-Fi cannot operate in some safety critical and hostile RF environments
- Wi-Fi capacity is limited by the available unlicensed spectrum

– Question

- What can solve these issues?

– Answer

- Multiple solutions solve the problems, including WiGig and LC.

LC complements Wi-Fi and WiGig in a similar manner to how WiGig complements Wi-Fi

	Problem Source	Alternative solutions	
	Wi-Fi	WiGig	LC
Confinement	✘	✓	✓
RF interference	✘	Mostly ok	✓
Spectrum	Increasingly Crowded	Additional in 60GHz	Additional in light/IR

LC/OWC has unique features that are beneficial in some environments

Spectrum

LC spectrum is globally harmonised & unlicensed

Spectrum is complementary and non-interfering to all existing and emerging 802.11 technologies

Energy

LC operates with potentially minimal extra energy requirements

Energy used for illumination is reused for communications

Global lighting standards provide **guaranteed signal strength**, e.g., mandatory office lighting levels

Infrastructure

LC provides new connectivity at low marginal cost

New wave in Power over Ethernet provides connectivity to the LEDs

The “transmit antenna” (LEDs) and access to power already available at installation site

Volumes

LC piggybacks on the lighting market

Over 550 million lights sold annually with 13% CAGR

Drive to provide energy efficiency and wireless communications can be combined

The demand for mobile wireless communications is increasing at over 50% per year creating a need for more spectrum

- Wi-Fi is ubiquitous, affordable, and offers performance that is well suited for current and emerging applications, untethered internet access via Wi-Fi is essential for consumers worldwide.
- User demand for data continues to grow at an exponential rate. IP traffic is projected to increase nearly threefold in the next five years with a majority of that traffic delivered over Wi-Fi.
 - <http://www.cisco.com/c/en/us/solutions/collateral/service-provider/visual-networking-index-vni/vni-hyperconnectivity-wp.html>
- The availability of corresponding unlicensed spectrum access has not kept pace with the extraordinary growth and adoption of Wi-Fi, and Wi-Fi functionality is dependent on adequate unlicensed spectrum access.
 - <http://www.wi-fi.org/beacon/alex-roytblat/wi-fi-study-reveals-need-for-additional-unlicensed-spectrum>
- Spectrum is scarce and there is increasing commercial pressure from competing technologies operating in the licensed band to access and influence access on currently license exempt spectrum.
 - <https://mentor.ieee.org/802.18/dcn/17/18-17-0073-00-0000-ieee-802-positions-on-wrc19-agenda-items.pptx>

The light spectrum has already been classified as license exempt from regulators

- “The Info-Communications Media Development Authority (IMDA) took steps to facilitate trials of the emerging technology, which uses light to transmit data wirelessly, by removing some regulatory barriers, including waiving spectrum fees in the 400-800THz band.” – IMDA, Singapore
 - <https://www.imda.gov.sg/regulations-licensing-and-consultations/frameworks-and-policies/spectrum-management-and-coordination/spectrum-planning/li-fi-technology>
- The Federal Communications Commission in the USA does not regulate frequencies above 3,000 GHz
 - https://www.ecfr.gov/cgi-bin/text-idx?SID=4bbc9fe06f4f8a5d00aada54fe757d3d&mc=true&node=se47.1.2_1106&rgn=div8
- “The LiFi technology uses unregulated spectrum of visible light that does not need licensing. On the other hand, it has to be ensured that the LiFi systems do not pose any health hazards and that they are correctly installed so that they do not create any EMI.” – OFCOM Switzerland
 - <https://www.bakom.admin.ch/bakom/de/home/das-bakom/medieninformationen/bakom-infomailing/bakom-infomailing-44.html>
- **International radio frequency spectrum regulation usually stops at 3 THz.**
 - <http://www.desktopsdr.com/more/worldwide-frequency-allocation-tables>

International radio frequency spectrum regulation usually stops at 3 THz.

- Australia – up to 3 THz.
- Bangladesh – up to 1 THz
- Brazil – up to 1 THz
- Canada – up to 3 THz
- China – up to 3 THz
- Europe – up to 3 THz
- India – up to 1 THz
- Japan – up to 3 THz
- Pakistan – up to 1 THz
- Thailand – up to 1 THz
- UK – up to 3 THz
- USA – up to 3 THz

- <http://www.desktopsdr.com/more/worldwide-frequency-allocation-tables>
- <http://www.miit.gov.cn/n1146285/n1146352/n3054355/n3057735/n3057748/n3057751/c4713815/part/4713817.doc>
- <http://www.erodocdb.dk/docs/doc98/official/pdf/ERCRep025.pdf>
- http://pta.gov.pk/media/Pakistan_Table_of_Frequency_Allocations.pdf

LC can address a number of different use-cases

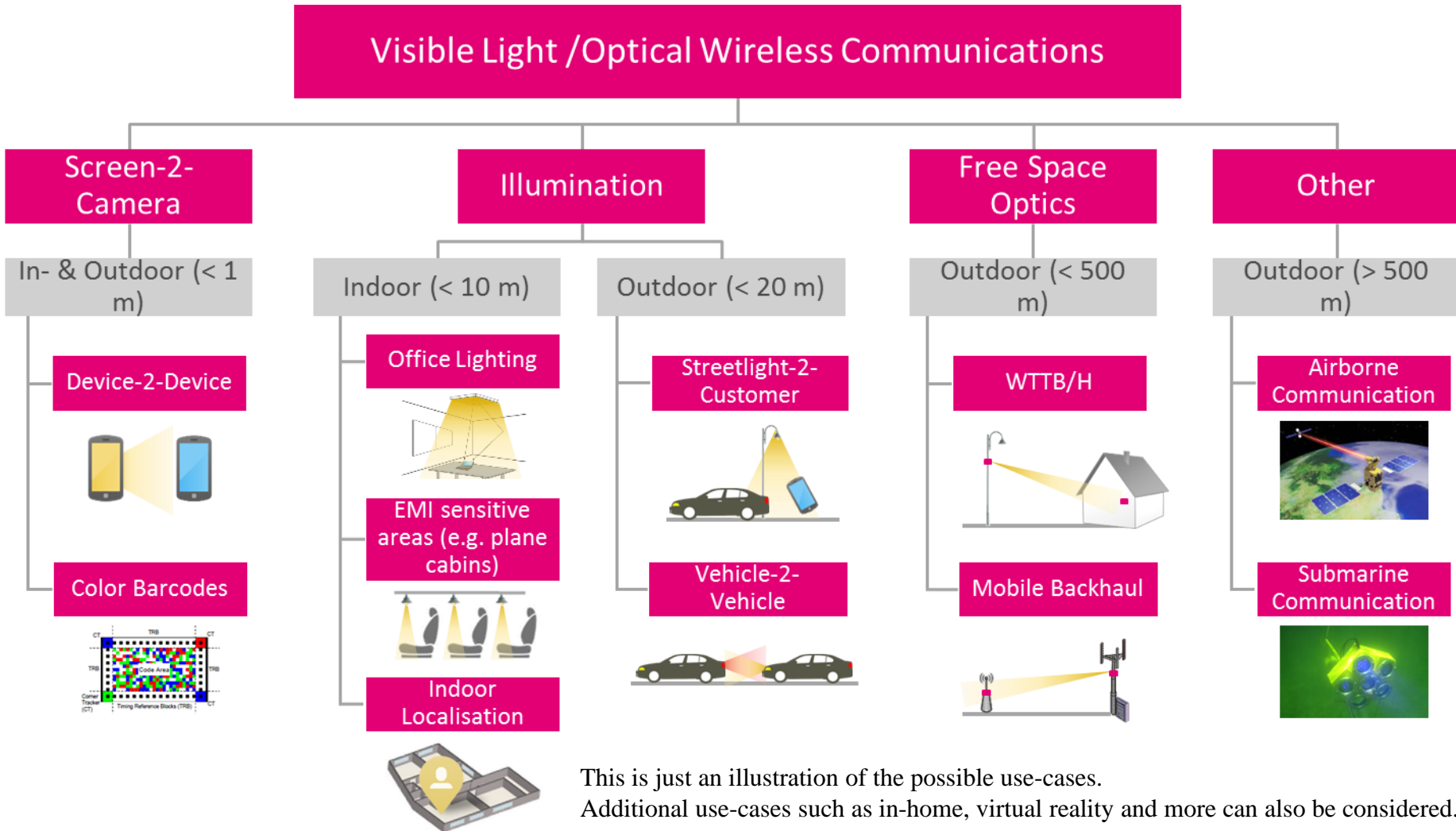

Optical Wireless Communication or LC “in a nutshell”

Basic Aspects

- Wireless communication via light
- Retain mobility by using LED lighting
- Bidirectional high speed data transmission

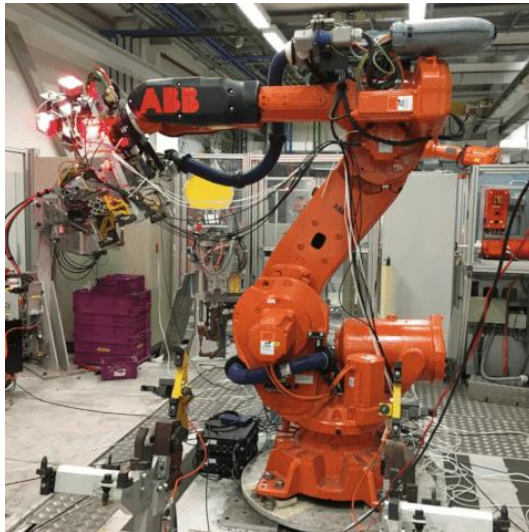

Unique Selling Points

- Ubiquitous LED lighting as “hotspot”
- Use of unregulated optical spectrum
- Light does not pass through walls
- No interference with radio

Definition of Optical Camera Communication (OCC)

An optical camera communication (OCC) is a system consists of a light emitting diode (LED) transmitter and an image sensor (IS) or camera as a receiver.

CMOS technology was used to develop an OWC system equipped with an optical communication image (OCI) sensor, and the design and fabrication of the OCI, as well as the development of an IS-based OWC system

- OCC enables wireless connectivity using infrared, visible or ultraviolet bands.
- With its powerful features such as high bandwidth (10,000 nm bandwidth in the optical domain), low cost and operation in an unregulated spectrum, OCC can be, in some applications, a powerful alternative to and, in others, complementary to the existing wireless technologies.
- The modulation schemes for OCC are most likely OOK, Undersampled based Modulation, Rolling Shutter Effect-Based Modulation, LCD-Based Modulation
- It is one of the most promising current areas of research with significant potentials for high-impact results which will considerably change the wireless market as well as communication via smartphone.

OCC using LED



Rolling Mode

- Records how state of LED changes
- Pixels are captured in sequential

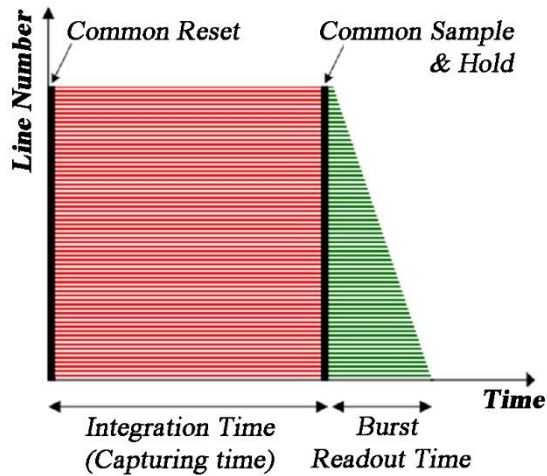

Receiver using rolling shutter image sensor

Global Mode

- Captures static state of LED
- All pixels are captured in parallel

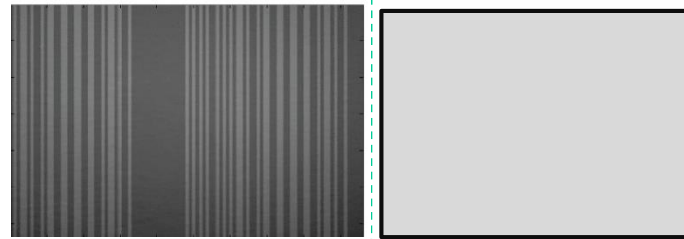

Rolling Image

Global Image

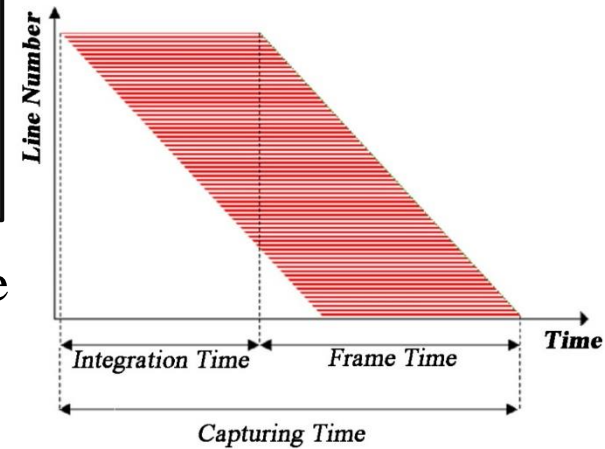

Receiver using global shutter image sensor

OCC : Basic Operation

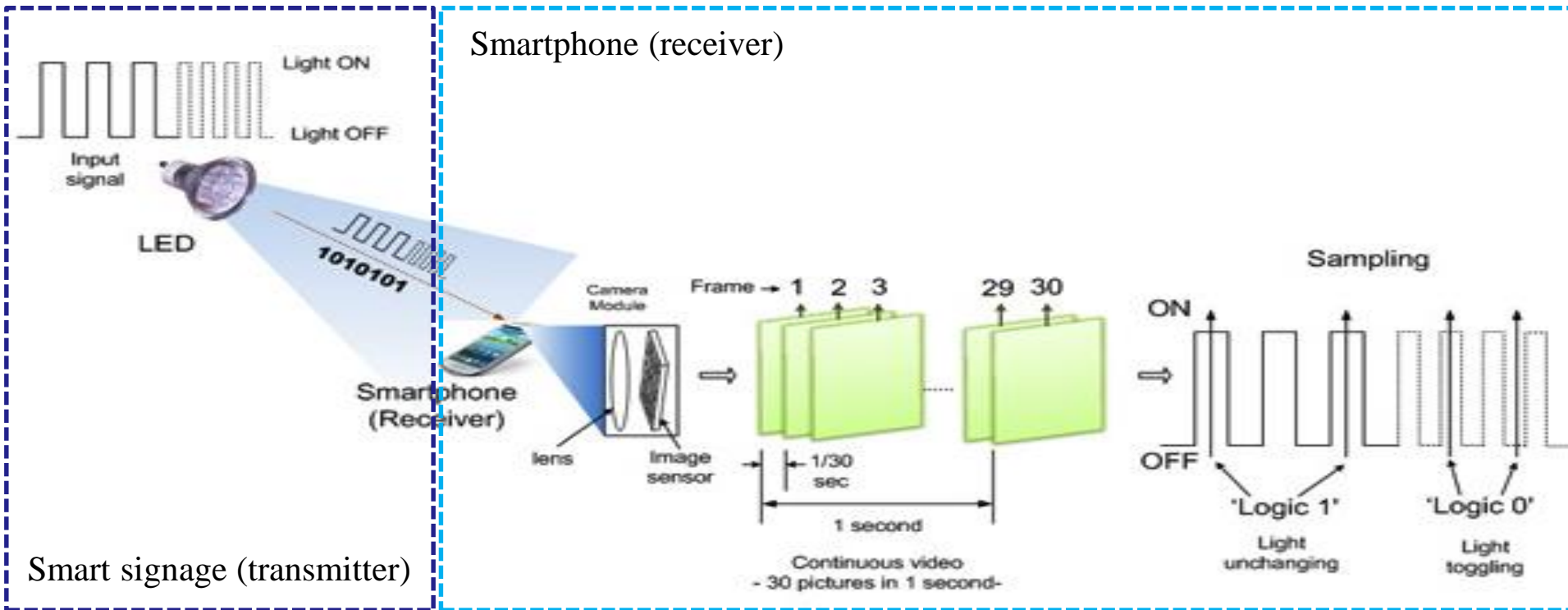

Add a simple Driver Circuit to existing digital signage, and add only image sensor communication app to smartphone (usually 30 frames / sec) without modification

Advantage of OCC

- **Non-interference communication:** When an IS is used as a receiver, lights from different sources are separated almost perfectly on a focal plane because there is a huge number of pixels in IS, and optical signals are output separately from each pixel, which prevents signals from becoming mixed.
- **High SNR value:** OCC system provides very high SNR level and therefore requires no complicated protocol for simultaneous communication among multiple LEDs
- **Simple signal processing technique:** The LEDs that are not required by receivers can be omitted entirely from IS because users can easily select communication partners from an image, and therefore, there is no need for complex signal processing to filter unnecessary information
- **Stable communication for dynamic positioning:** The optical signal power received by IS is stable against changing communication distances. Therefore, the incident light power per pixel remains unaffected in spite of variations in communication distances, so long as the imaged LED size on the focal plane of the IS is not smaller than the pixel size
- **Huge unregulated bandwidth in the optical domain**
- **Spatial separation capability**

Reference architecture for rolling shutter based OCC systems

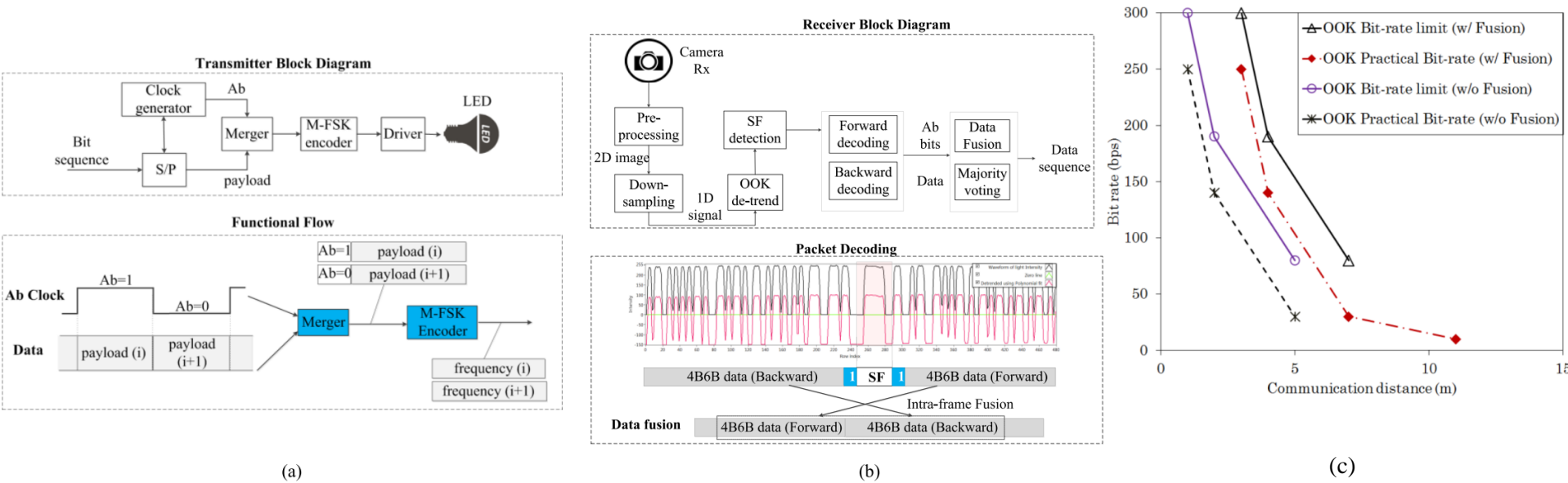

Reference architecture for rolling shutter based OCC systems. (a) Rolling shutter OCC reference architecture employing CM-FSK. (b) Rolling shutter OCC reference architecture employing OOK (c) Distance improvement of packet fusion technique

Related OCC Technology Status



Ceiling light Flash light Car light Indirect light



Illuminated/LED signage



Traffic light



Lighthouse



Digital signage

PHY Layer	Explanation	IEEE 802.15.7m OWC TG Baseline Document D3
IV	Discrete (or single) source	<ul style="list-style-type: none"> - UFSOOK - S2-PSK - S8-PSK - Hybrid Spatial PSK - Offset-VPWM
V	Surface source	<ul style="list-style-type: none"> - Twinkle VPPM - RS-FSK - CM-FSK - C-OOK - MPM
VI	2-dimensional /screen source	<ul style="list-style-type: none"> - A-QL - VTASC - SS2DC - IDE - Sequential Scalable 2D Code Modulation - Hidden A-QL

Application scenario for OCC



Indoor Environment
Localization and Marketing with ISC



Outdoor Environment
Digital Signage

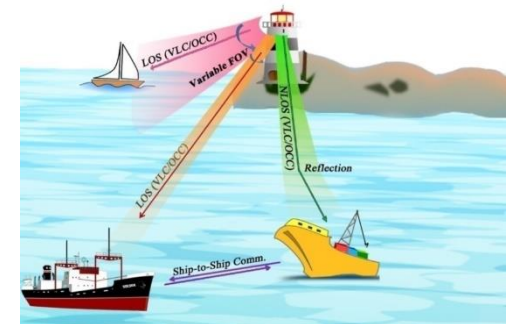

Seaside Environment
Lighthouse-to-Ship/Ship-to-Ship

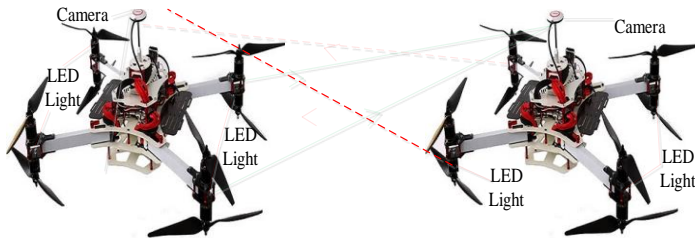

Drone to drone communication
for collision avoidance

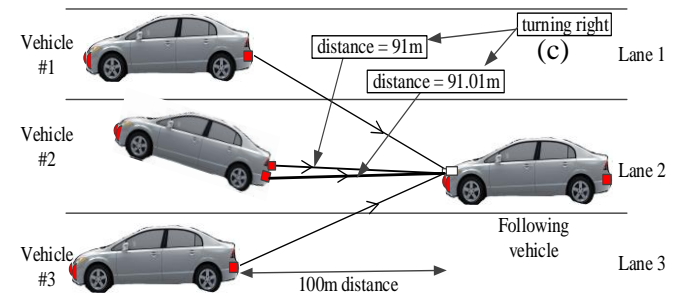

Vehicle to vehicle communications

Reference architecture for Region of Interest (RoI)

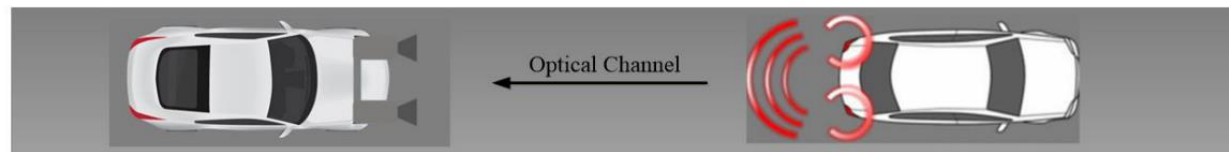
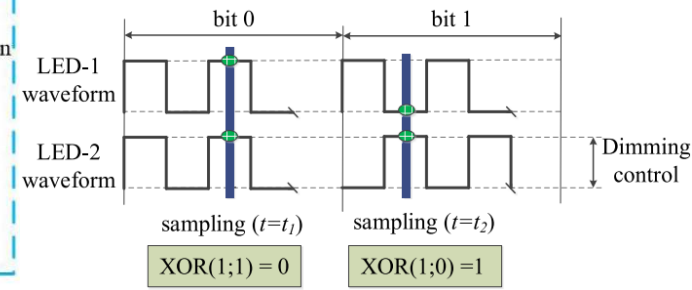
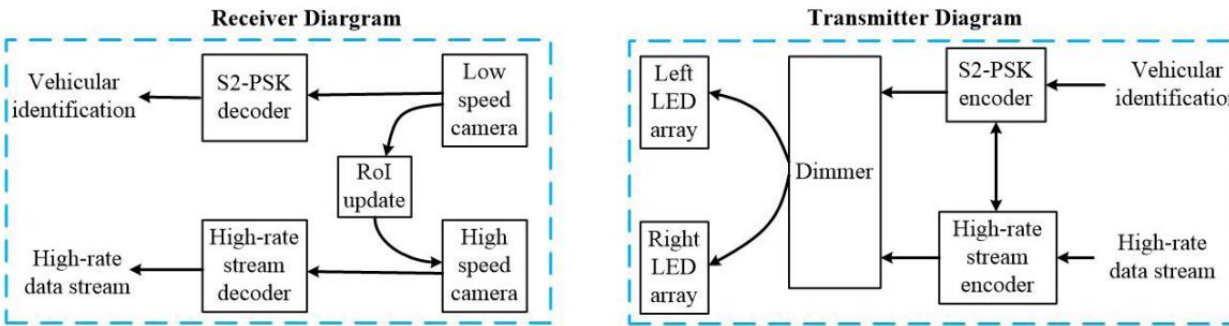

Reference architecture for RoI signaling system employing S2-PSK

RoI signaling waveforms

Vehicular OCC system employing S2-PSK modulation

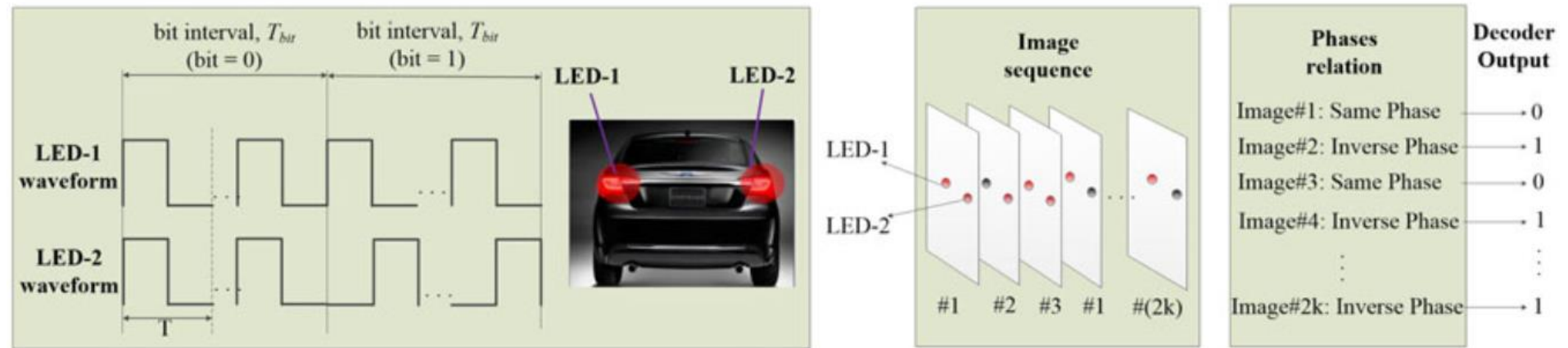
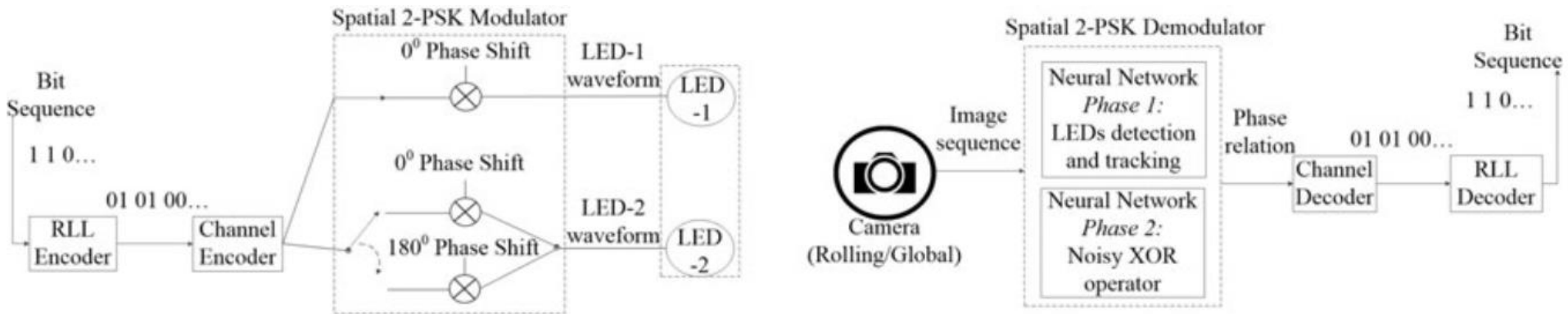

Vehicular OCC system employing a proposed S2-PSK modulation

What is feasible using standard LEDs?

- Using Draft IEEE 802.15.13 (D0)
- High-Bandwidth PHY, 100 MHz
- Two different LED driver modes

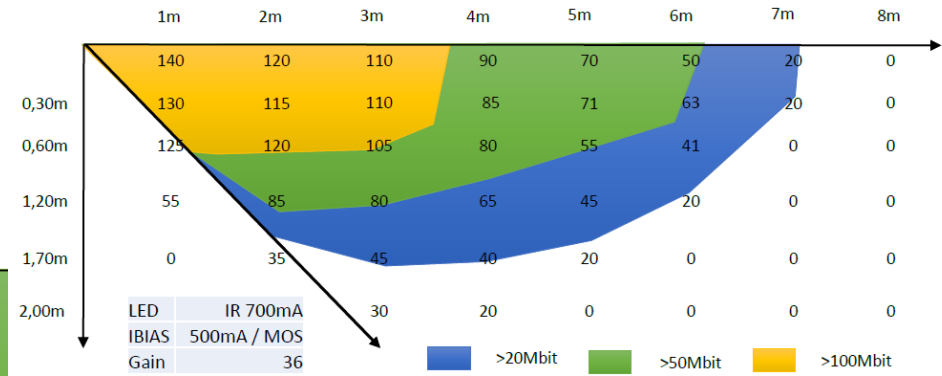
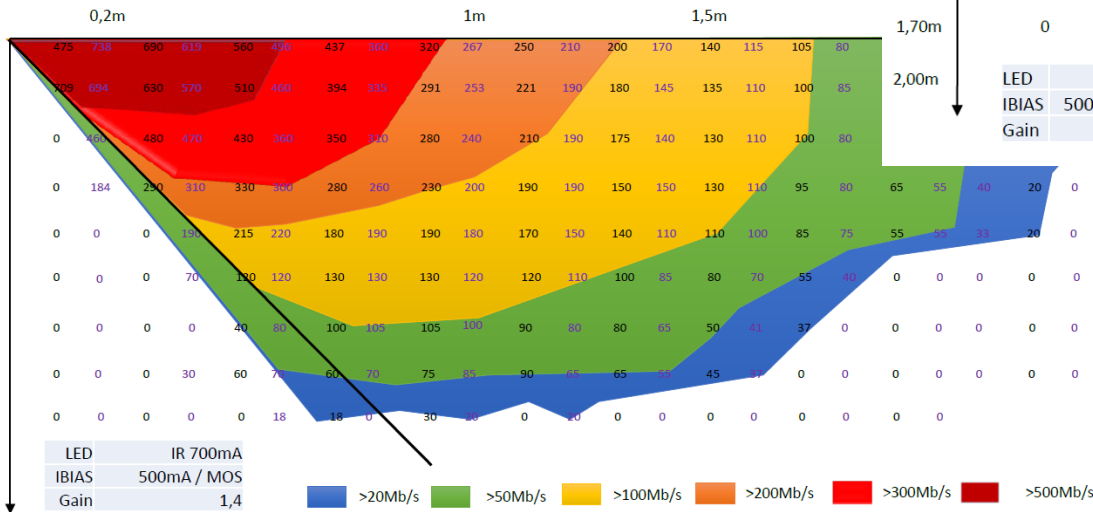

Limited rates, but improved coverage

Higher rates, but limited coverage

- Tens of centimeters with **>500 Mbit/s**, few meters with more than **100 Mbit/s**

Roadmap from research into application

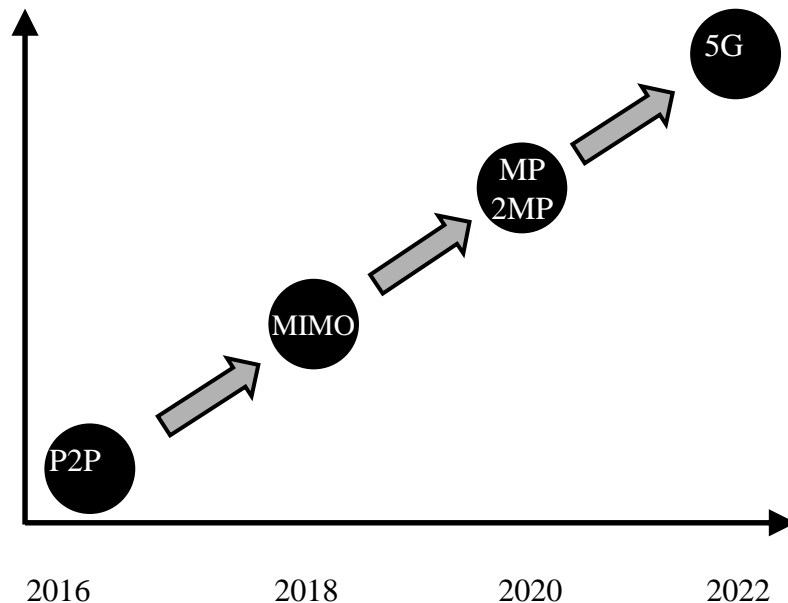

- P2P: Point-to-Point
- MIMO: Multi-Input-Multi-Output
- MP2MP: Multi-User Multi-cell
- 5G: 5G Network integration

Use-Case: Mobile Backhaul

- LED-based OWC Link for 50-200 m
 - 1 Gb/s P2P link in outdoor housing
 - Same electronics like in 1G VLC link
 - Rate-adaptive DC-biased OFDM
 - Easy adjustment, low fabrication costs



500 Mbps @ 100 m

No interference with
RF

No license fees

High availability

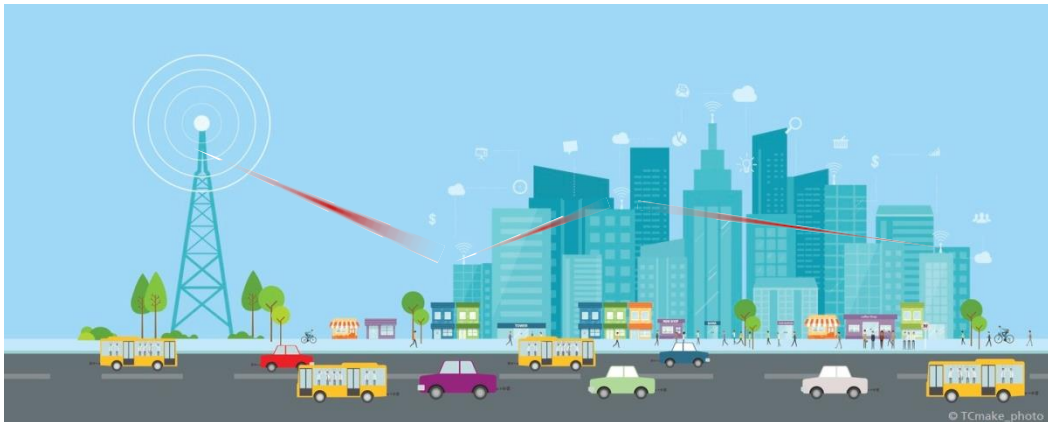

Market Potential

- Backhaul for 5G deployment
- Networked streetlights
- Wireless to the Home
- Mobile networks for big events



Mobile Backhaul Results

- Rate adaptation overcomes fog and sunlight
- **Field trial (Dec. 1 2016 – Feb. 28 2017): Hybrid OWC/60 GHz link**
- **Visibility always >100 m, Rate adaptation allows robust operation despite fog/sunlight**
- **No outage observed so far in two field trials, benefits of fine-granular rate adaptation**
- **Optical link is faster 90% of time, use adaptive OWC/mm-wave link aggregation**

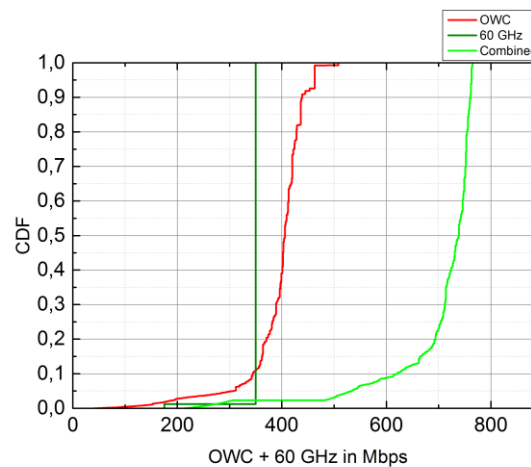
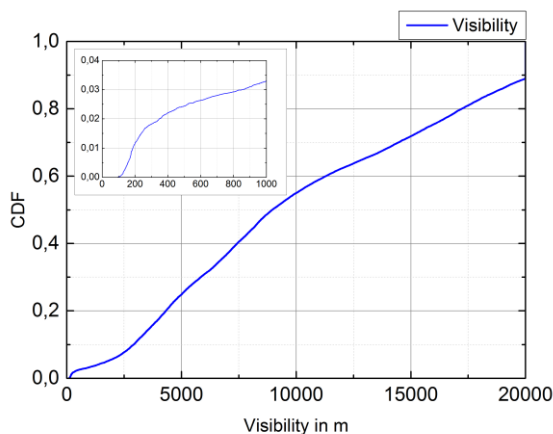

5G X *Crosshaul*
the integrated fronthaul/backhaul

Use-Case: Industrial Wireless

- Distributed MIMO enables robust OWC link
- Industry 4.0 requires robust wireless connectivity → use MIMO!
- Use multiple omni-directional Tx at robot and distributed Rx
- First MIMO measurements in the robotics lab at BMW

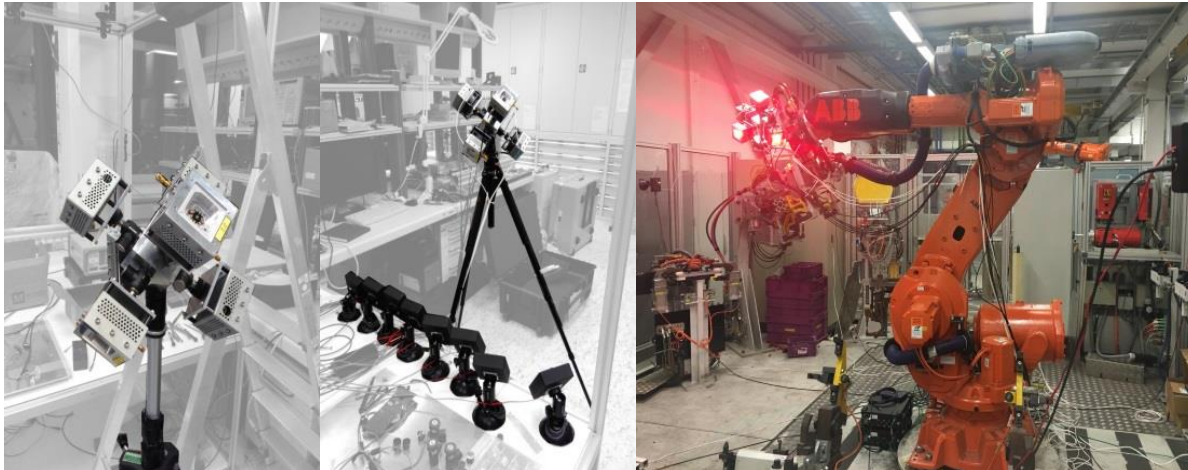
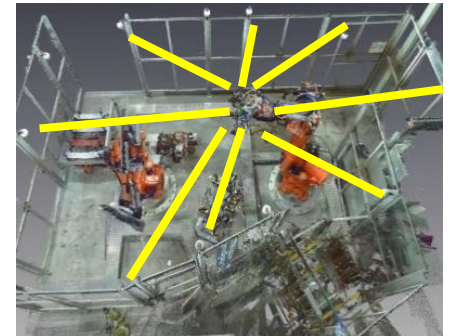
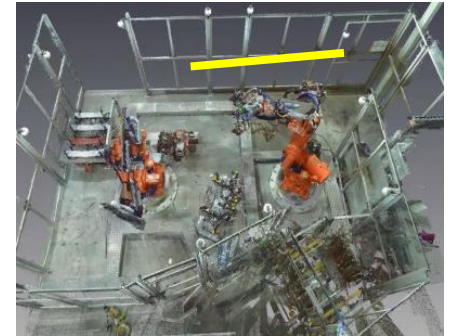

it's possible!
evopro



Industrial Wireless Results

- Distributed MIMO Setup
- MIMO measured along robots trajectory
- 6 Tx at robots arm point to all directions
- 8 Rx at the wall of manufacturing cell
- General observations
 - SNR is poor in such wide-beam setup
 - Difficult to bridge realistic distance
 - System design will differ from high SNR scenario typical for Li-Fi
 - Few MHz bandwidth, SC modulation
 - Diversity-oriented MIMO

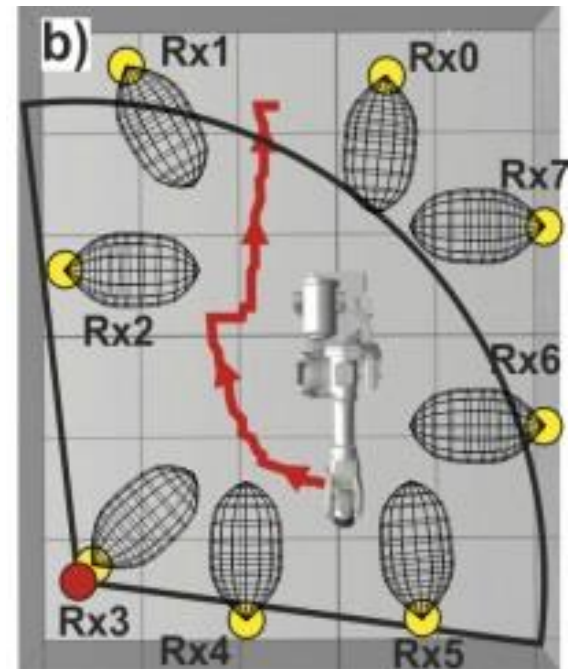

Industrial Wireless Results

- Spatial diversity overcomes blocked line-of-sight (LOS)

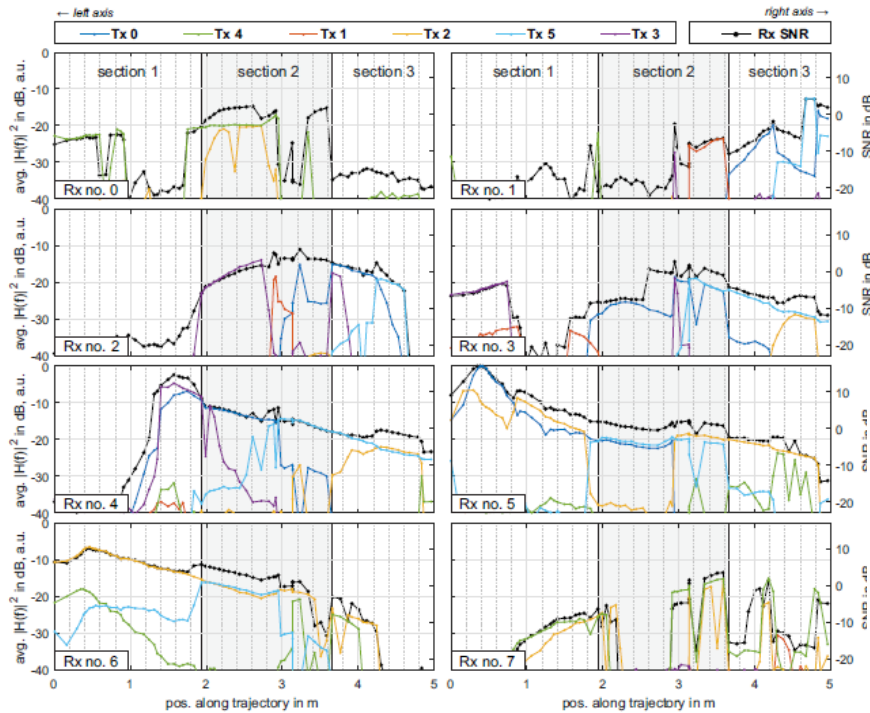

- MIMO measured along robots trajectory
- Fast time variance due to blocked LOS
- Spatial diversity creates robust OWC link

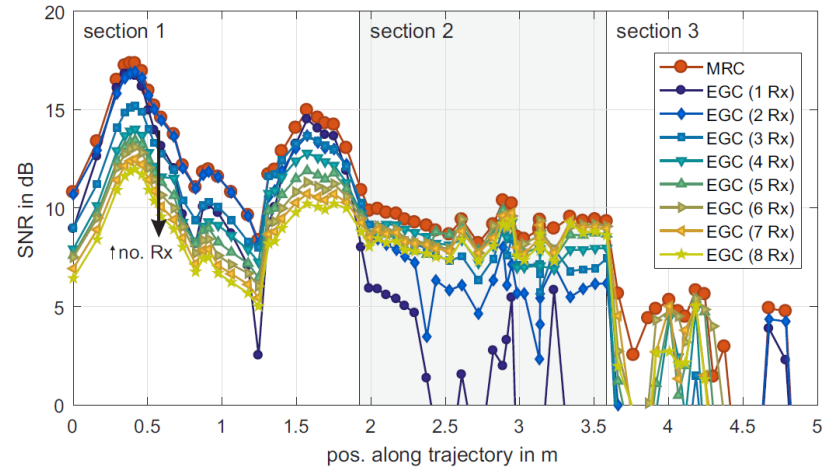

Use-Case: Industrial and Public/Private Premises

- Optical overlay for Wi-Fi: LC
- Combination of illumination and wireless “hotspot”
- Downlink using visible light, uplink based on infrared
- Dynamic rate adaptation supports user mobility
- Pilot installations on the island of Mainau and in the city of Stuttgart



STÜTTGART



Use-case: Industrial – provide RF interference free, deterministic, communications within industrial and automated work cell areas

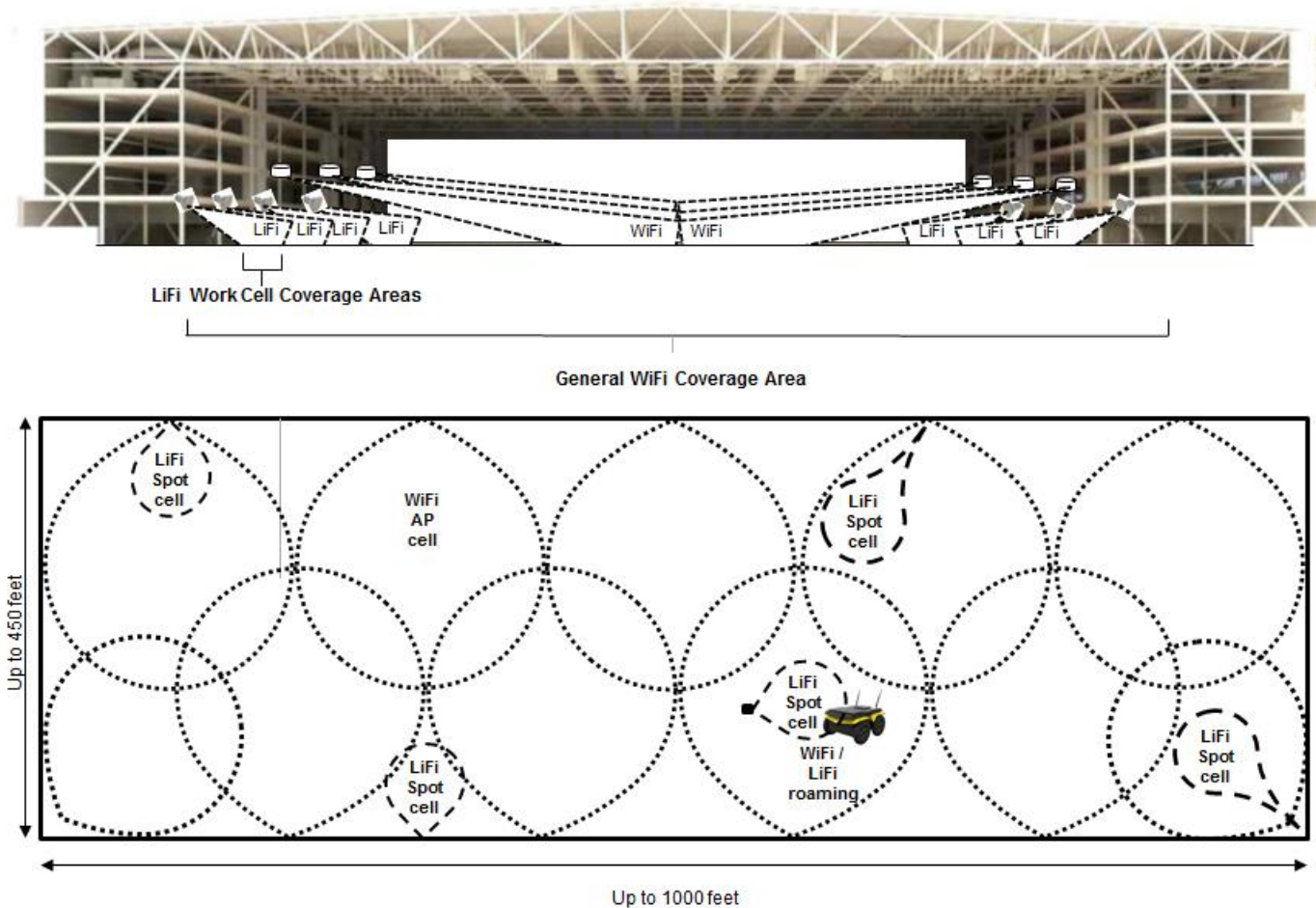

Industrial and Public/Private Premises Results

- Combination of Wi-Fi and LC, multi-user support
- Aggregation of both links is the best idea for mobile access
- Multiple user support (P2MP) works in real-time at 1 Gb/s!
- Further standardization is needed to enable MP2MP operation
- Vertical and horizontal handover, interference management

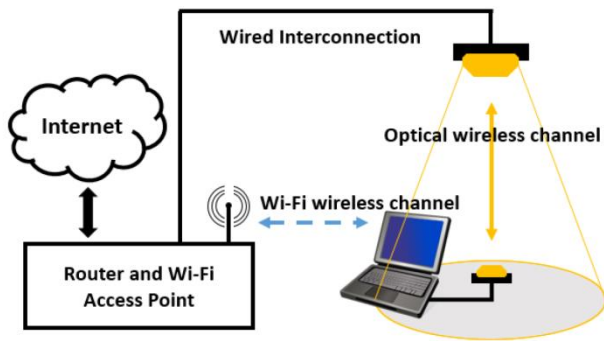

(b) Aggregated system model

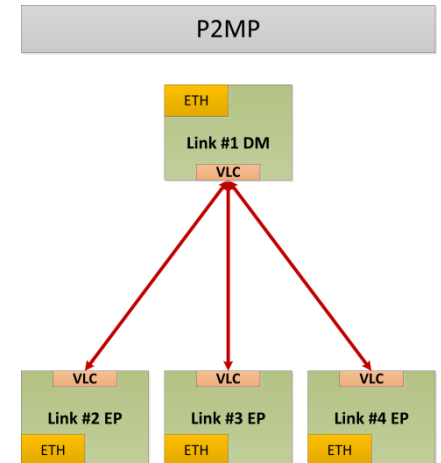
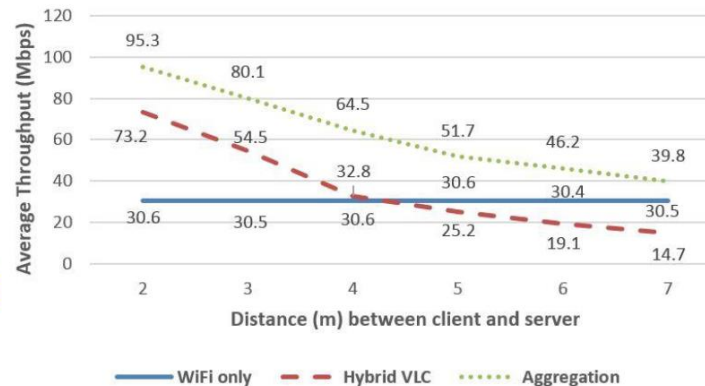

Use-Case: Enterprise – LC can enable link aggregation alongside other 802.11 technologies, improve security and expand access in EMI-sensitive markets

- LC does not cause any interference with other RF technologies and the licence exempt spectrum along with the dense cell deployment, means that LC can be used to deliver link aggregation, releasing precious spectrum at the lower bands for other applications.
- Radio Frequency (RF) communications in the lower spectrum cannot be deployed in areas that are particular sensitive to electromagnetic interference (EMI).
- LC can enable 802 technology to expand in adjacent markets such as hospitals, mining, nuclear power plants and more.



Use-case: Home – LC can provide link aggregation and increased security

- **Users can intuitively understand the best coverage locations, by seeing the light.**
- Similar to the Enterprise environment, LC can offer link aggregation and wireless data off loading
- Various stationary devices, such as TV or speakers, can be connected wirelessly and securely through LC without occupying the lower RF spectrum
- Virtual reality goggles can be connected to provide a highly localized and high capacity channel



Use-case: Retail – LC enables rapid alteration of retail space to create new customer experiences as a key part of retailer strategy

- Density of light fixtures and LC APs allows highly precise localisation of users and paths. This enables the provision of navigational directions for users within a store or mall.
- Data density of LC enables very-high bandwidth content without fear of interference with other wireless resources.
- The fact that light is non-penetrative and highly containable enables the establishment of very secure wireless signals.
- Highly reliable, secure and flexible retail space connected through LC enables cost reductions for retailers when modifying or refitting the space.



Use-case: Internet of Things – homes, cities, factories, healthcare and more

- Home
 - Connecting devices that convey sensitive information like CCTV cameras, baby monitors, etc. via a more private and secure LC network.
- Cities
 - LC AP can be installed on street furniture and ease congestion on spectrum resources by off-loading and releasing RF spectrum
- Factories
 - High requirements with respect to robustness (availability), low latency and security.
 - Very high cell density deployments as a complement to RF
 - LC is inert against RF jamming and EMI, the propagation is confined, and it does not create EMI.
- Healthcare
 - Providing the same reliability and security as a wired connection with the flexibility of a wireless solution for indoor communications,
 - Reliable and precise indoor positioning for patient/doctor/asset tracking
 - Wireless connectivity in EMI sensitive environments like operating theaters or MRI rooms.



The uniqueness of the different IEEE 802 OWC standards

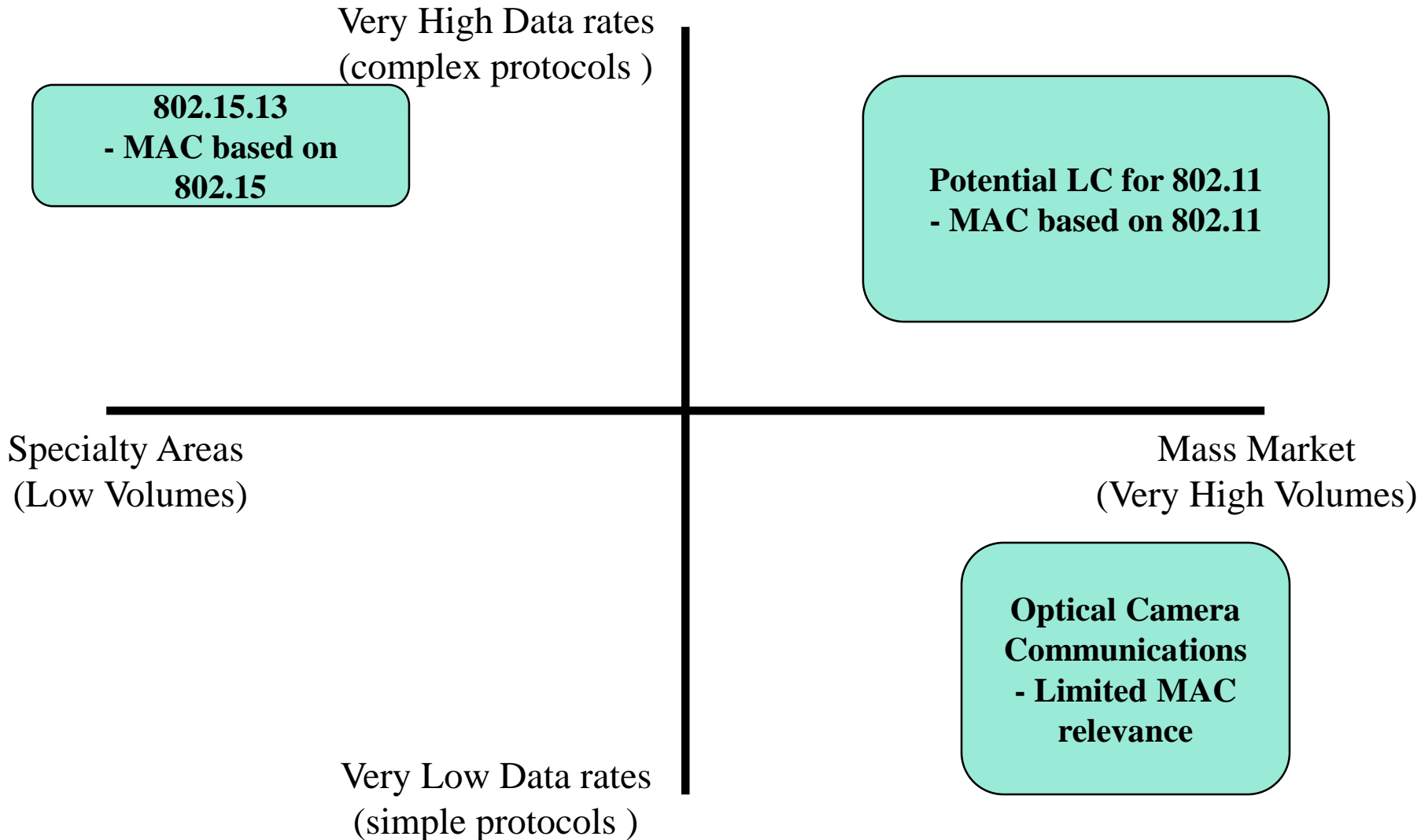

LC does not have the same constraints as the original 802.11 IR PHY in the operating environment

Time has changed key factors relative to 802.11 IR PHY

Components

- Improved Components have created a global drive to use LEDs offering better energy efficiency, range and data rates.

Energy

- LEDs are being used for illumination and communications, removing constraints on the transmit power for the downlink.

Use-Cases

- Complementary deployments to Wi-Fi with:
 - Data off-loading
 - IoT
 - Localization
 - Etc.



Example of an OFDM modulation and demodulation chain for LC

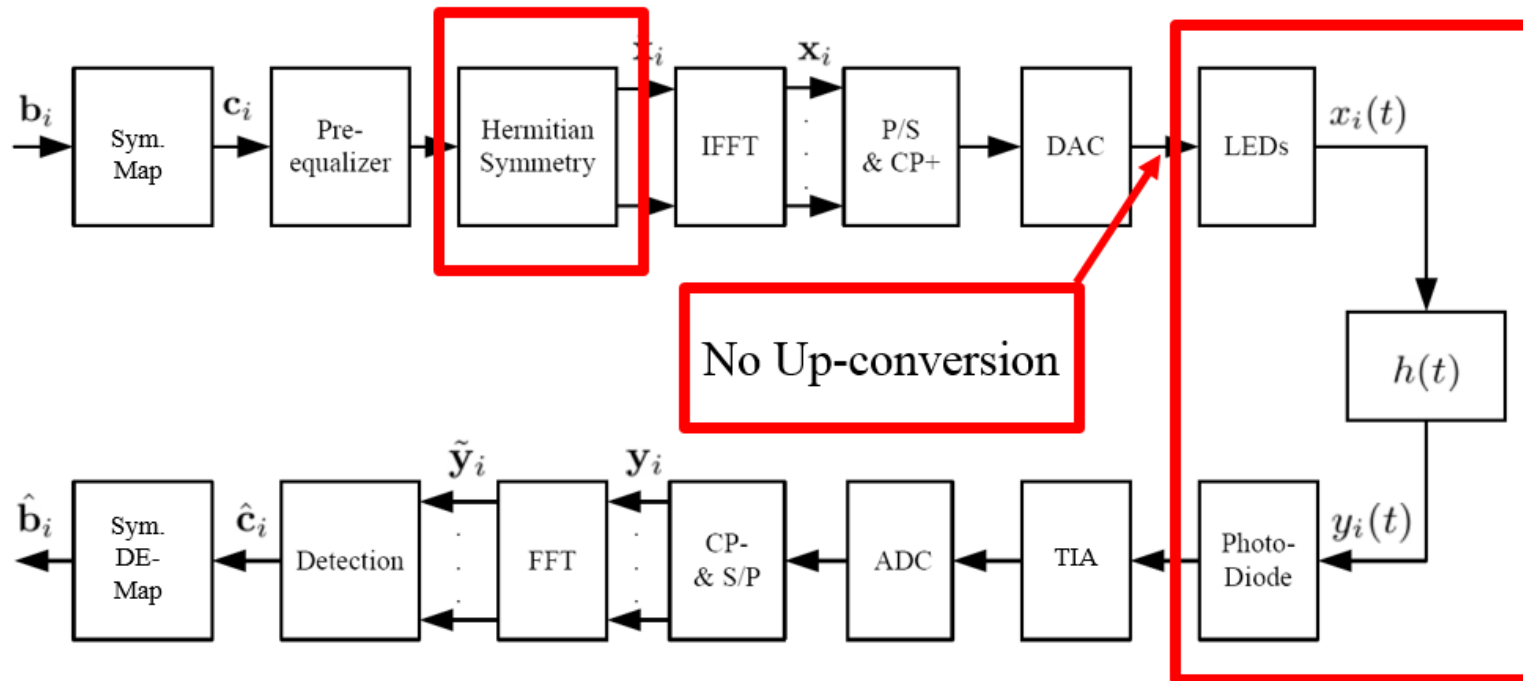

Example of DFT-s-OFDM modulation and demodulation chain for LC

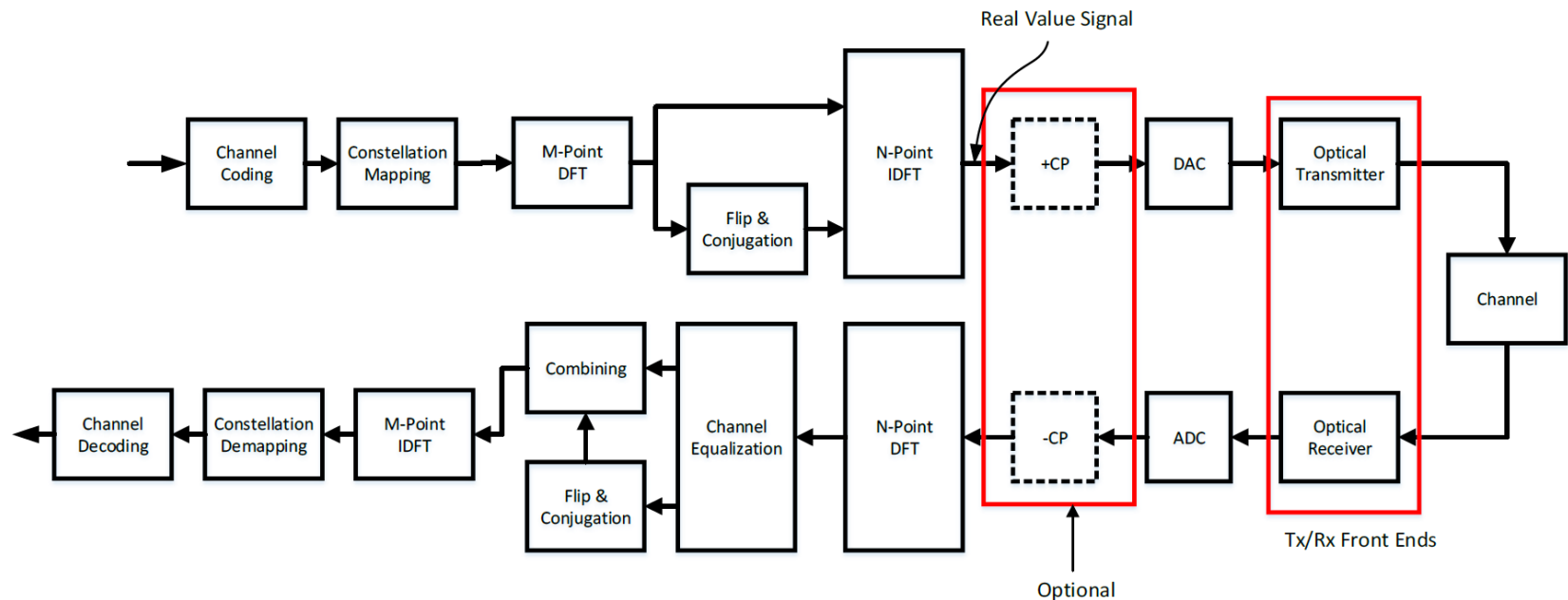

How does uplink of LC-systems work?

- LC can also be used for uplink.
- For devices that have RF capabilities, it is envisioned that RF communication may be used for uplink (hybrid LC/RF), as well as in parallel to light communication for “link aggregation” for both up- and downlink (aggregated LC/RF).

Does LC impact the colour quality of lighting?

- No, for a DC-balanced modulating signal, with a non-varying average value, any fluctuations in the instantaneous driving current due to data modulation do not have any significant impact on the measured light quality metrics.

- **“Provided adequate thermal management is used, the average drive current dictates the emitted light quality (CRI, CCT and chromaticity) but not the instantaneous drive current. Hence to preserve the expected light quality of LEDs used for LiFi, the modulating signal must be balanced.”**
 - W. O. Popoola, “Impact of VLC on Light Emission Quality of White LEDs,” Journal of Lightwave Technology, Vol. 34, No. 10, May15, 2016.

IEEE 802.11 can bring high-speed LC to the mass market faster and in a more comprehensive manner other SDOs

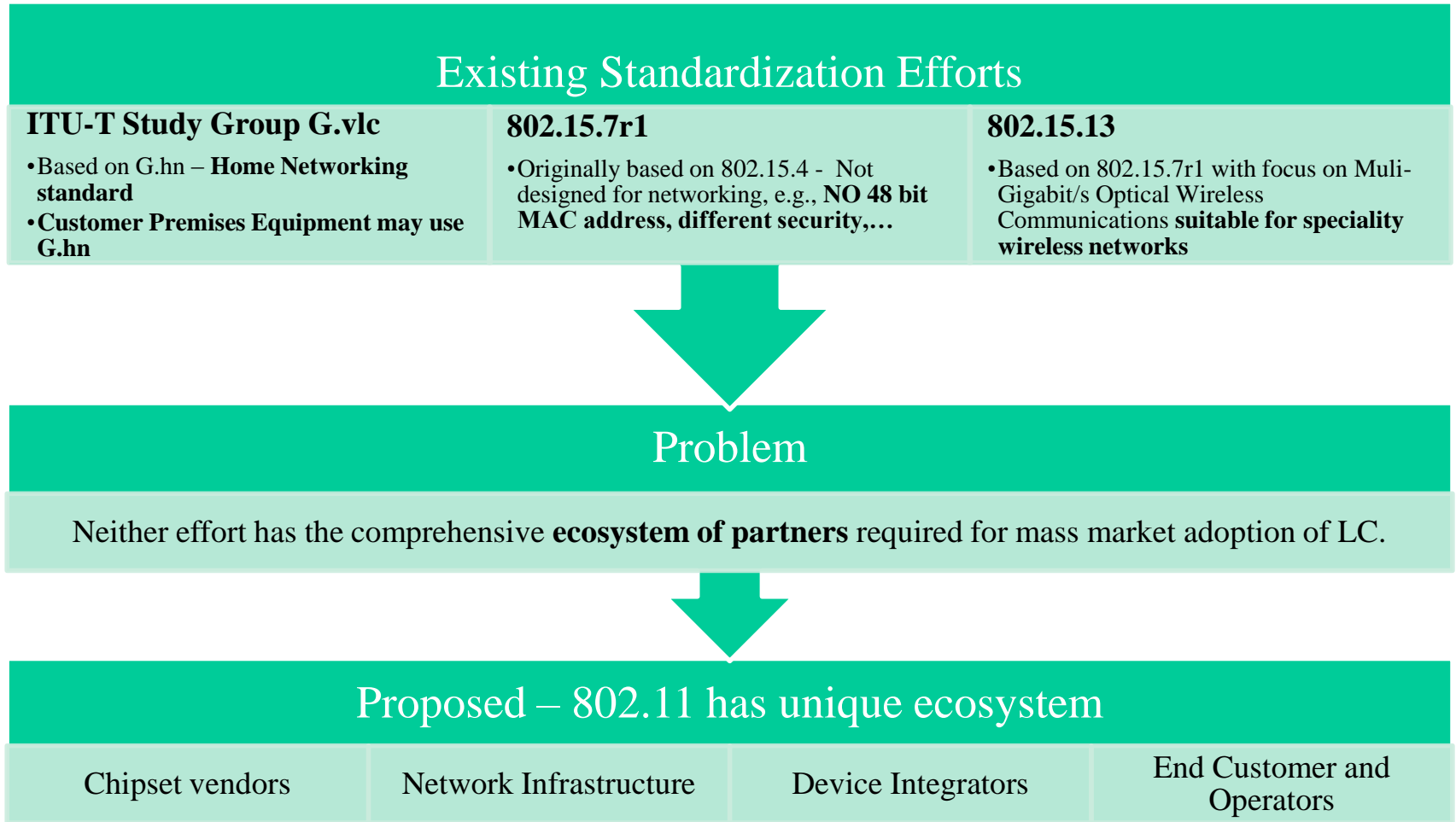

The 802.11 offers a unique collection of the relevant ecosystem partners and technological capabilities relevant for LC standardization

- The difference between LC and the existing 802 light communications standards is the use of the 802.11 MAC and associated services that are already optimized for low-cost wireless local area networks relative to the other efforts (802.15.7r1 and 802.15.13) efforts that are focusing on deploying the technology for wireless specialty networks.
- The existing standardization efforts aim at short-term market opportunities while taking higher energy consumption and higher costs into account
- The coexistence and hand-over with other 802.11 PHY types creates a unique market capability for LC as part of 802.11.
- The well established commercialization steps from technology standardization in 802.11 through to product certification, offer a unique capability to drive rapid product introduction in the market.
- LC in 802.11 is seen as way forward to introducing the technology the mass market

A number of LC demonstrator systems exist with no interoperability and a need for standardization

- There are numerous wireless LC systems demonstrated delivering data rates from 1 Mbps through to multiple Gbps from entities such as Fraunhofer HHI, FireFly, VLNcomm, Oledcomm, pureLiFi, etc.
- However, these systems are generally based on proprietary technologies and there is a growing need to standardize the technology.

Economic Considerations for LC

The infrastructure necessary for LC is already being installed and PoE adoption for lighting is accelerating

- Lighting infrastructure is one of the first elements added when constructing a building
- Power over Ethernet (PoE) is increasingly used to provide a backbone for lighting in new office buildings as it offers reduced deployment cost and time.

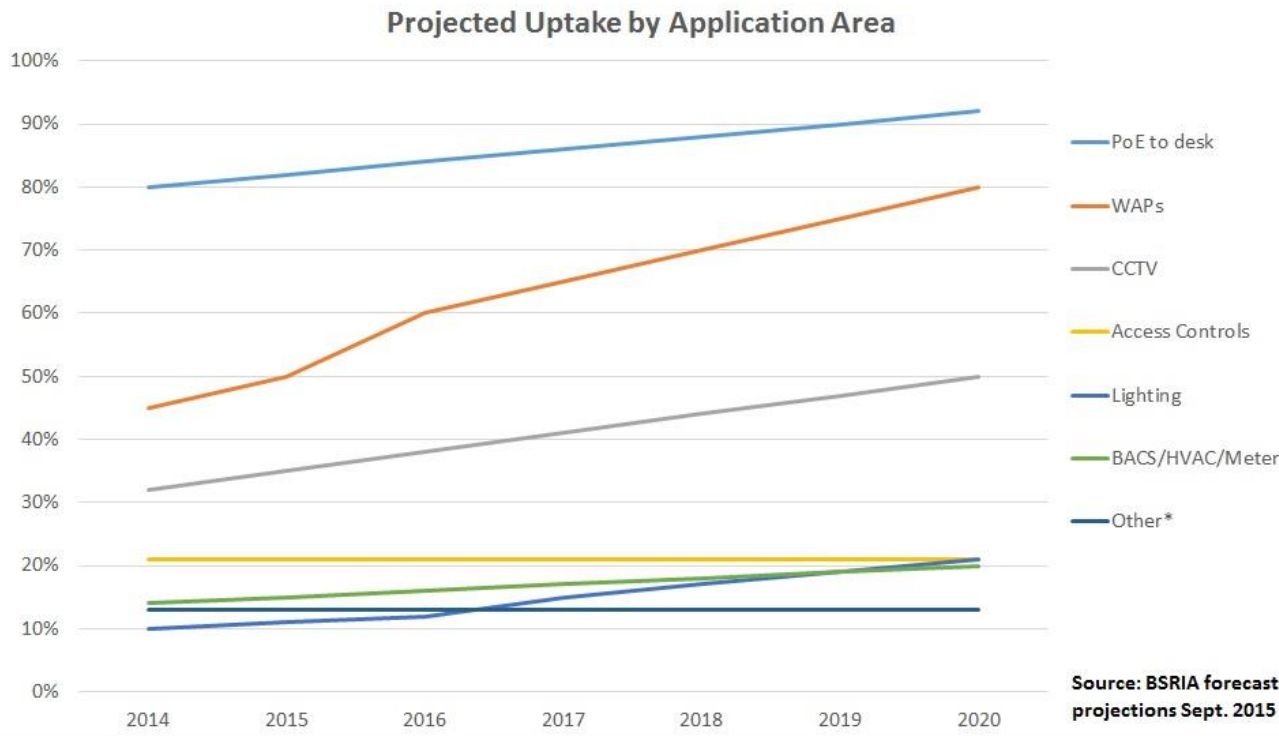

The Edge Building in Amsterdam has over 6500 PoE powered LED lights connected to a Building Management System and offered a 25% reduction in installation costs with over 50% reduction in installation time

LED lighting in 2017 still accounts for <10% of the over 45 billion lighting sockets available

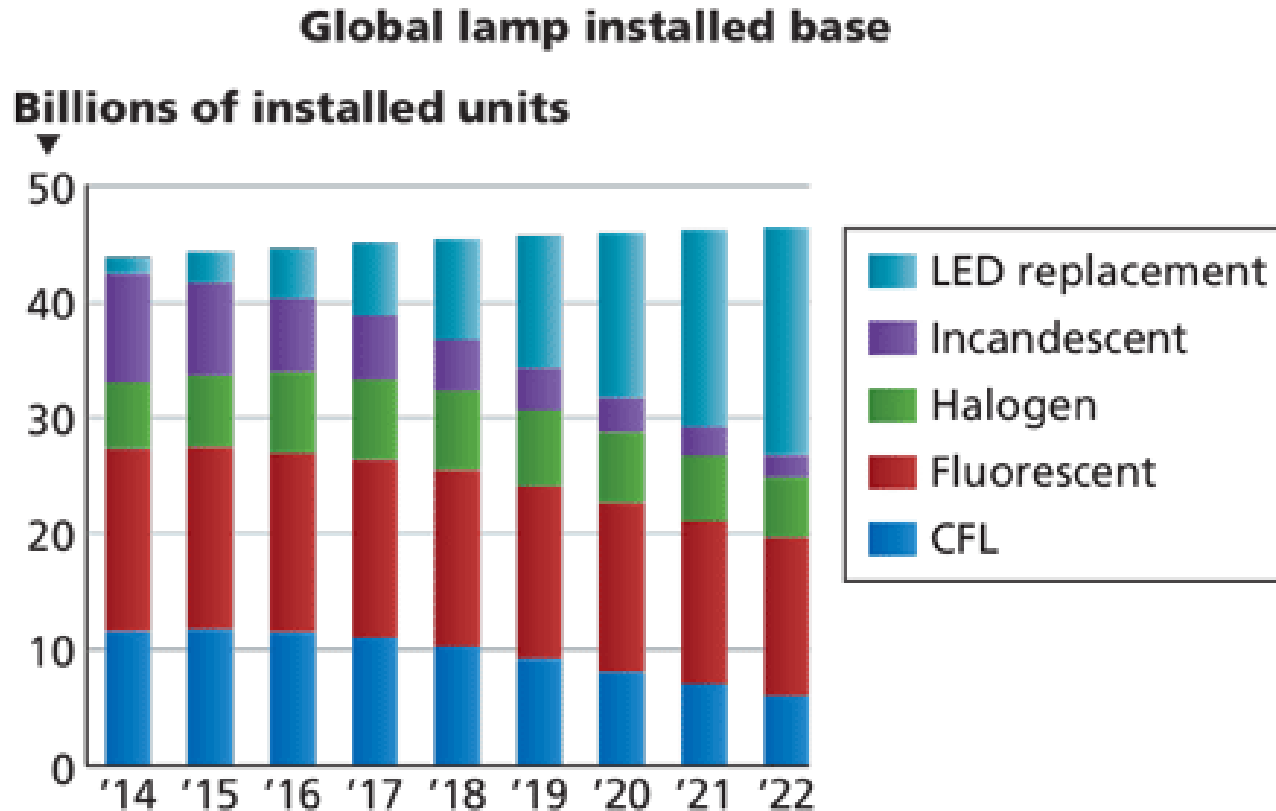

Source: Philip Smallwood, co-chair of Strategies in Light and director of research at Strategies Unlimited presenting at the The LED Show conference, March 1 – 3, 2016

LED lighting will replace over 50% of the current compact fluorescent lighting by 2020

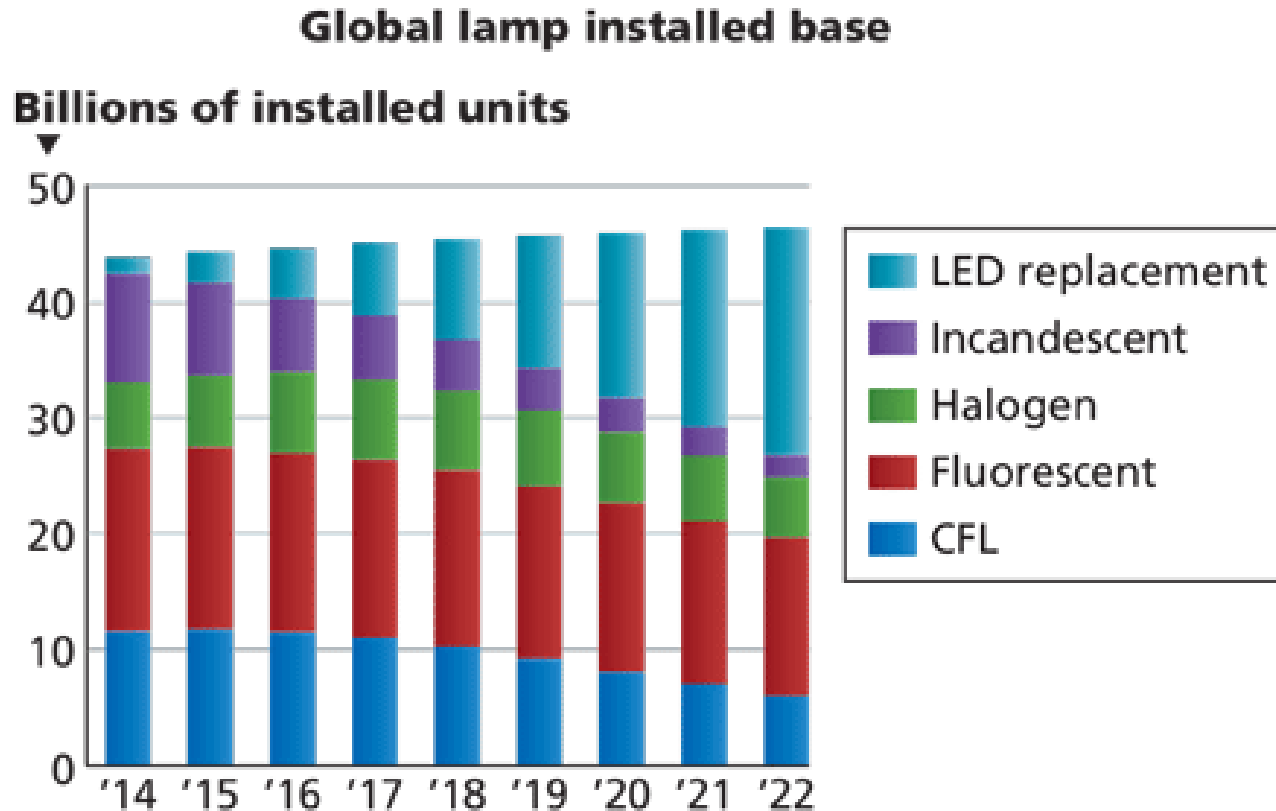

Source: Philip Smallwood, co-chair of Strategies in Light and director of research at Strategies Unlimited presenting at the The LED Show conference, March 1 – 3, 2016

LED lighting accounts for over 50% of the revenue for the lighting industry in 2017 and are fast replacing traditional light sources

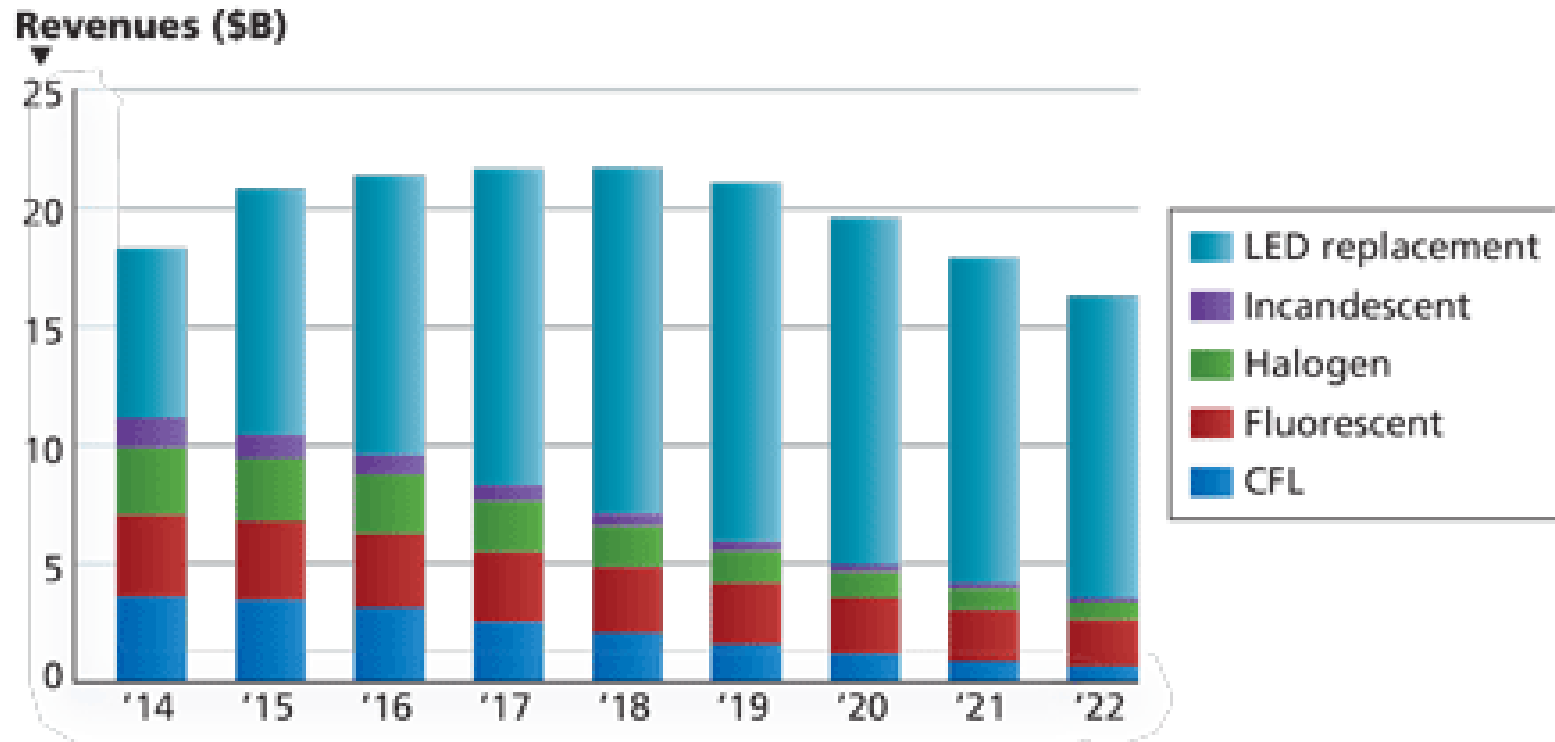

Source: Philip Smallwood, co-chair of Strategies in Light and director of research at Strategies Unlimited presenting at the The LED Show conference, March 1 – 3, 2016

Sustained supply growth in LEDs has resulted in cost erosion and lower regular retail price (RRP) creating an opportunity for value add solutions in the cost structure

FIGURE 10 / LED PAR38 75W Equivalent Pricing Trends (\$/unit)

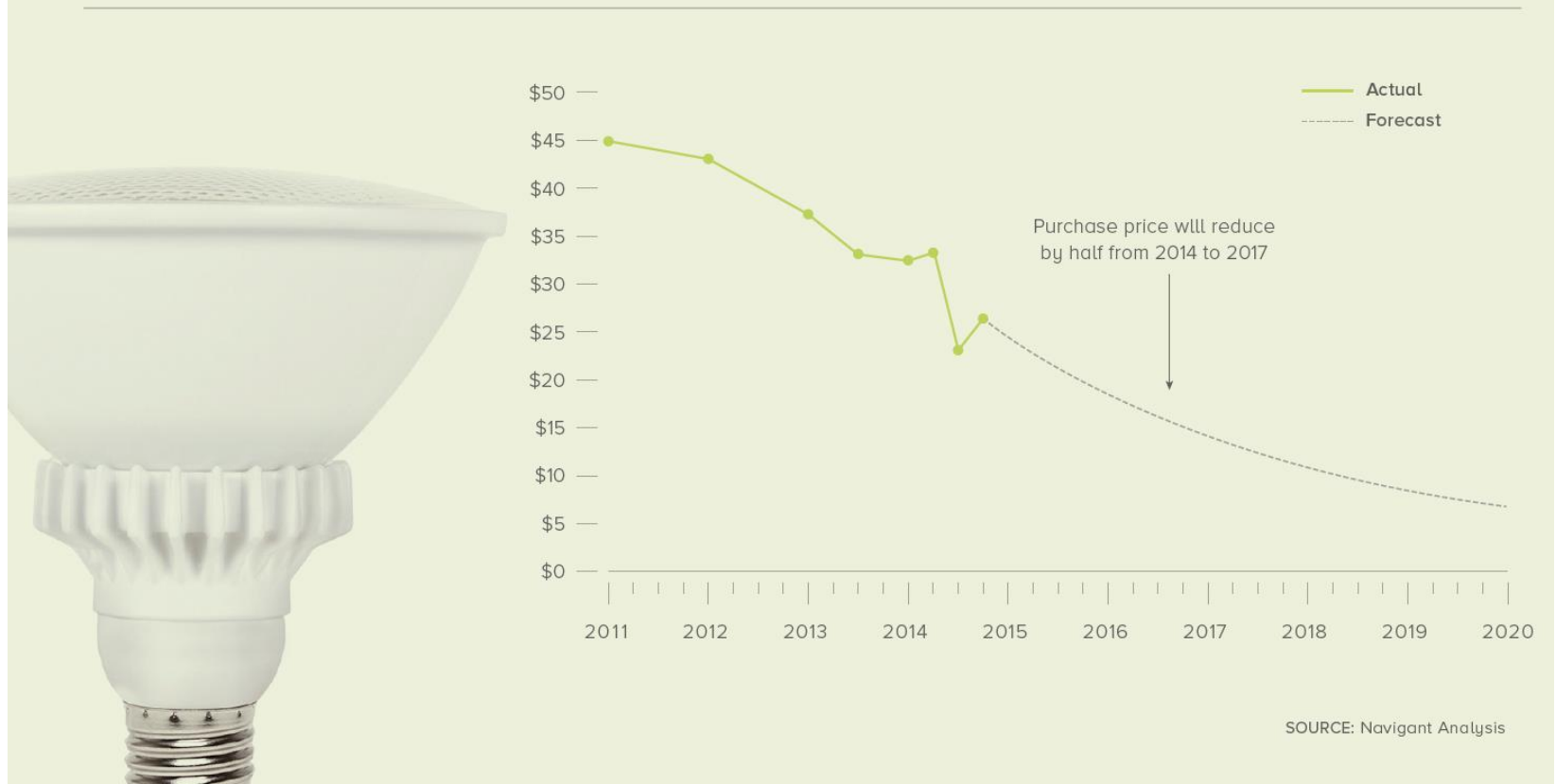

Over 550 million LED luminaires (lights) are projected to be sold in 2017 – each could be LC-enabled

Global Luminaire Unit Shipments

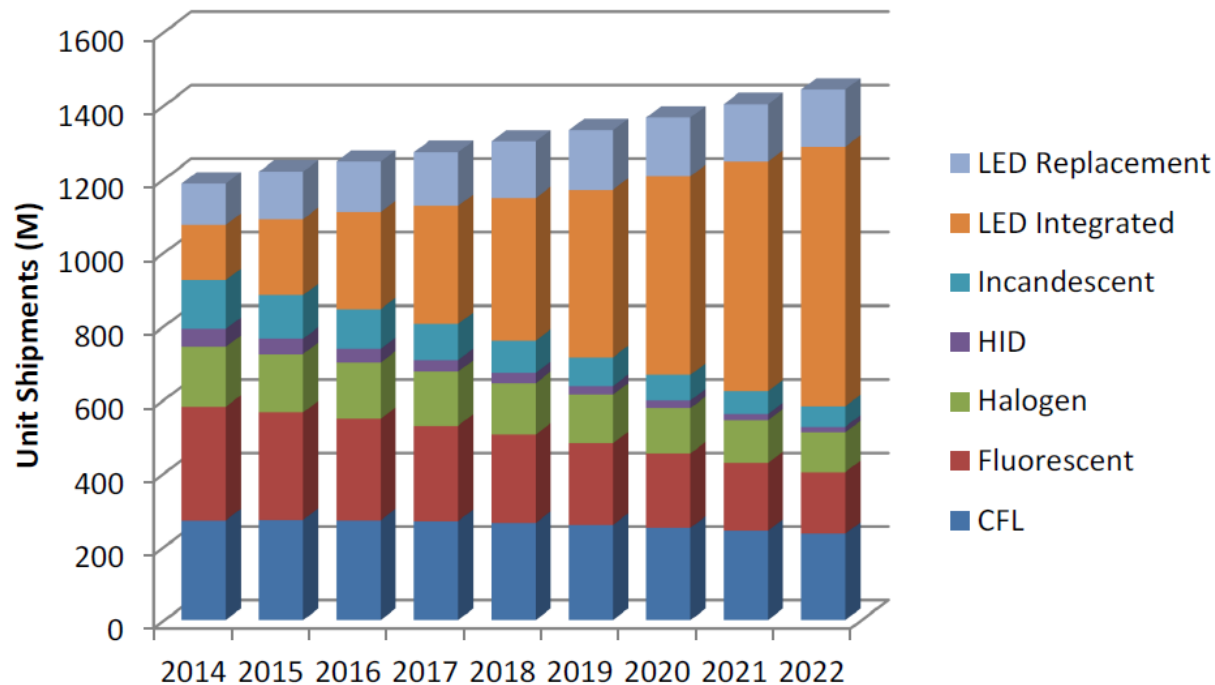

Source: Philip Smallwood, co-chair of Strategies in Light and director of research at Strategies Unlimited presenting at the The LED Show conference, March 1 – 3, 2016

Lighting emission efficacy for LEDs is projected to saturate by 2030. The corresponding plateau of the cost creates an opportunity to add additional services.

Average lighting efficacy (light output per unit of energy consumed) and cost per bulb

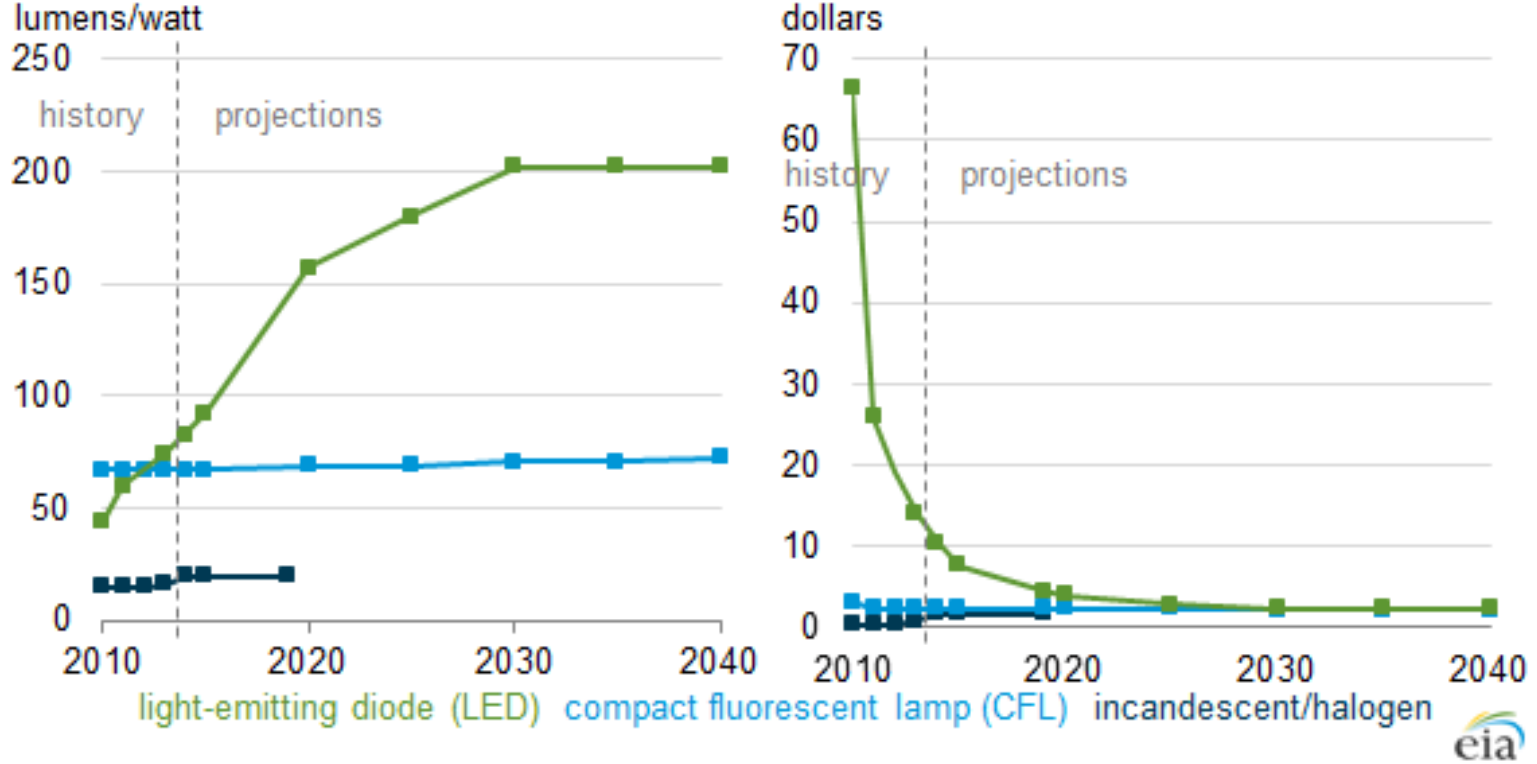

Light communications capabilities could be added to LED lights at a limited cost considering the increasing proliferation of multiple wireless comms. modules in lights

- The cost for simple LED drivers is between \$10 - \$50 for commercial (enterprise and industrial industries) LED drivers and lower for the general consumer market.
- The growing trend and competition in LED lighting is creating cost erosion in the market and there is an opportunity within the lighting industry to create added value.
- The addition of various communication chips in LED lighting drivers is already underway with various Wi-Fi, Bluetooth, ZigBee, LoRa and other wireless communication modules already introduced in lighting drivers, such as:
 - LIGHTIFY by OSRAM (https://www.osram.com/corporate/lightify/lightify-pro/lightify_pro_products.jsp)
 - Philips Hue (<http://www2.meethue.com/en-us/products/>)
 - C-life by GE (<https://www.cbyge.com/products/c-life>)
 - Cree connected light (<http://creebulb.com/connected-60-watt-replacement-soft-white>)
- The addition of LC as part of a comprehensive 802.11 communications module can create new market opportunities for both, the lighting industry and the wireless communications industry.

The price-point for commercial and industrial LED lighting are higher than for the general consumer market with an expected product replacement cycle of 5 – 10 years.

- The emergence of Light as a Service business model is the next step in the evolution of the lighting industry.
- With the introduction of smart lighting control and increasingly the Internet of Things (IoT) connectivity modules, the lighting industry is relying more on creating value for the end customer based on the available data about the building and behaviour or the users.
 - Examples of location-based services with Philips Lighting in Carrefour in France
 - The Edge Building in Amsterdam
- This shifting business model in lighting can leverage light communications and other wireless communications to improve the utility of lights.
- **The 5 – 10 year product replacement cycle is similar to the evolution of various 802.11 standards, ensuring that the future lighting sockets can all have 802.11 technologies embedded in the next generation of devices.**

Over 72% of the global use of electricity is in Commercial and Residential premises

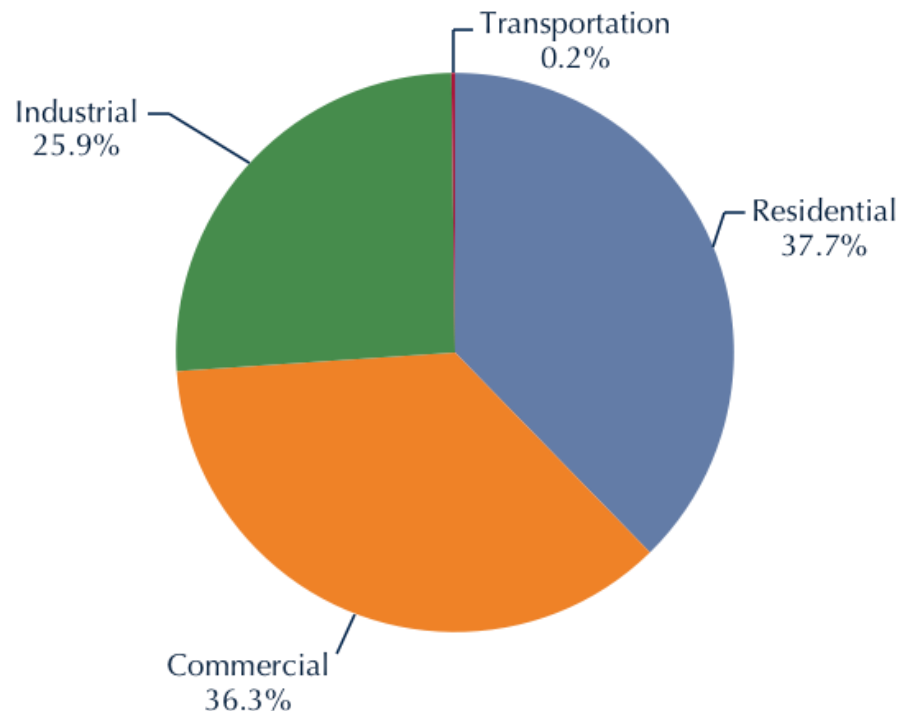

- Retail Sales of Electricity to Ultimate Customers, Total by End Use Sector (2013)

- Source: EIA, *Electric Power Monthly*, Table 5.1, May 29, 2014.
http://www.eia.doe.gov/cneaf/electricity/epm/table5_1.html.

Lighting will always consume energy - over 13% of global electricity use.

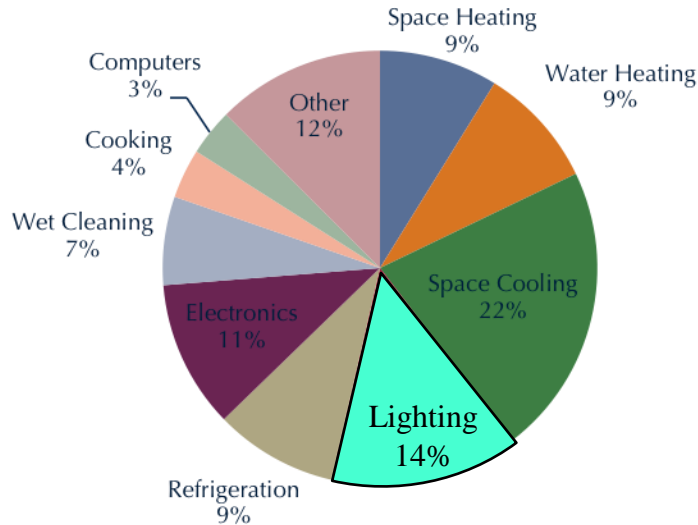

- **Residential** Electricity Consumption by End Use (2010)

- Source: DOE, *Buildings Energy Data Book*, Table 2.1.5, March 2012.
<http://buildingsdatabook.eren.doe.gov/ChapterIntro2.aspx>.

- **14% of residential electricity use is consumed by Lighting**

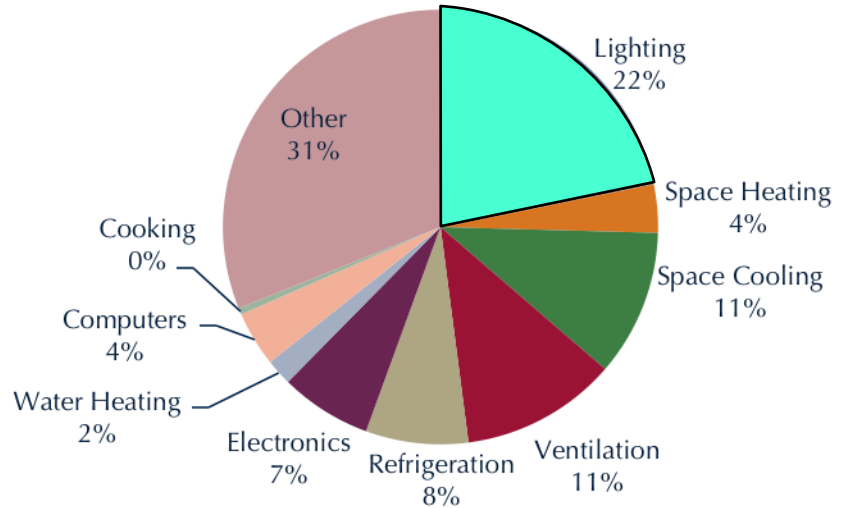

- **Commercial** Electricity Consumption by End Use (2010)

- Source: DOE, *Buildings Energy Data Book*, Table 3.1.5, March 2012.
<http://buildingsdatabook.eren.doe.gov/ChapterIntro3.aspx>.

- **22% of commercial electricity use is consumed by Lighting**

LC can use the energy already consumed for illumination to provide wireless communications

- Lighting consumes over 13% of global electric energy
- Aside from illumination, the energy used for lighting can also be used to provide some heating (98% of the energy used by incandescent lights is generated as heat)
- LC can use the energy consumed by lighting to provide wireless communication and therefore avoid the waste of energy

Lighting consumes more electrical energy than the entire “cloud” and this can be used to offset the energy required for wireless transmission

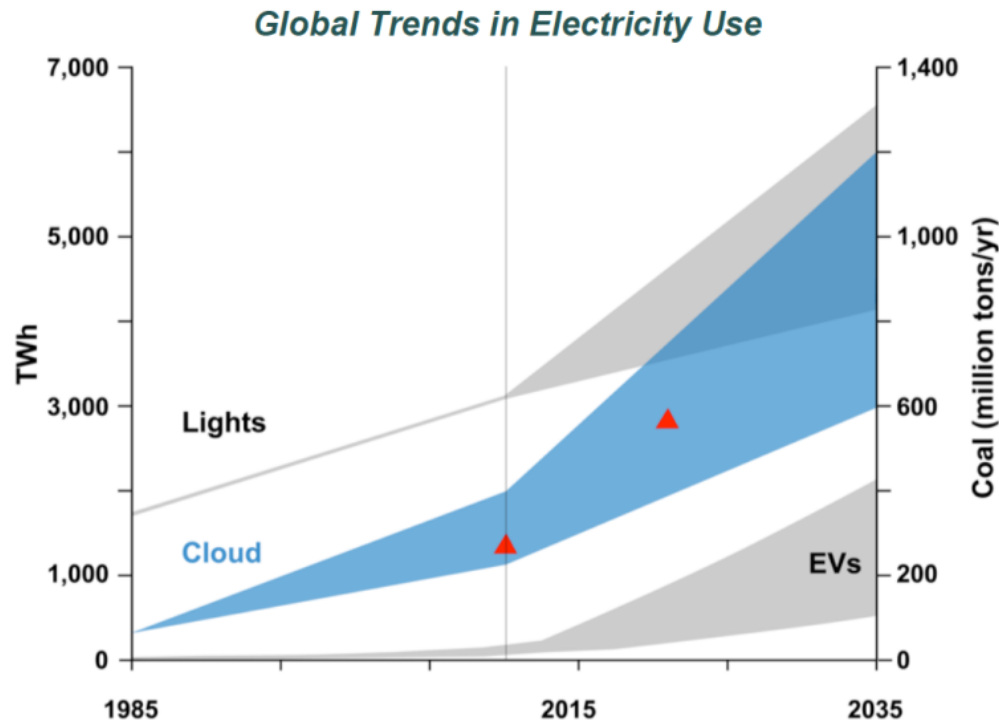

Data Source: For EVs, [Polk](#) & calculation; lights from IEA; Cloud from this report. One industry analysis forecasts 2020 ICT energy use at 140% of today's level.⁹⁴ Greenpeace estimates it will triple in a decade.

– Source: Boston Consulting Group SMARTER

LC can increase the sustainability of wireless communications and maintain the industry growth rates

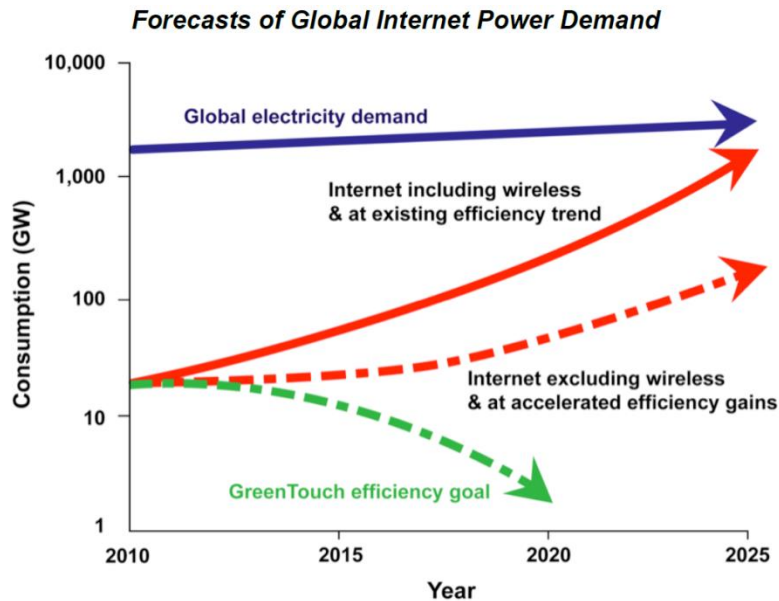

Source: [GreenTouch](#), [CEET](#)

- Source: Centre for Energy Efficient Telecommunications (CEET)
- GreenTouch is an industry initiative to reduce the energy consumption of wireless communications, *e.g.*, by reducing the wireless cell sizes.
- The current energy demands for Internet access are due to hit the limit of the global electricity demand by 2025 if current efficiency trends are maintained and a large part of the energy consumption can be attributed to wireless communications.
- LC can reuse the energy consumed for illumination to offset the energy required for wireless transmission by offering wireless communication capabilities to lighting devices for a marginal increase in the energy consumption of the devices.
- Therefore, LC can increase the sustainability of wireless communications and maintain the industry growth rates.

LC has comparable energy efficiency to 802.11 and more available energy for the downlink

Energy Requirements

Available

- Lighting is already present and consuming power
- Regulation requires minimum indoor illumination levels

Computational

- Similar complexity as existing 802.11 PHY and MAC protocols

Radiated

- More energy is required to achieve the same distance as RF due to smaller wavelengths and intensity modulation / direct detection

The costs for integrating LC in mobile devices are well understood in the industry

- LC requires optical elements for the transmission and detection of modulated light signals as well as digital signal processing elements.
- An increasing number of industries have and are introducing optical detection modules (eg., digital cameras) in mobile devices, cars, industrial devices and more with known cost factors.
- The mobile devices industry has a clear understanding of the associated costs and integration effort for multiple communication modules.
- LC modules that can be integrated in mobile devices could easily scale to be deployed in multiple other verticals.

LC devices are expected to have substantially similar complexity and therefore cost as existing Wi-Fi chipsets

- The creation of a LC standard within 802.11 would ensure that aside from the physical modulation (transmitter and receiver) devices, the remaining elements would have substantially similar capabilities and therefore similar device costs as existing Wi-Fi products.

- On the access point side:
 - There are over 550 million LED lights sold annually with a 13% CAGR.
 - Each light already has the transmitting element (LEDs)
 - Each light already has the required connection to the backbone (assuming power line communications or PoE connectivity)
 - Each light already has the AC/DC conversion circuitry
 - Each light would need only a LC chipset along with the relevant receiver (LED driver and photodiode)

- On the device side, each mobile phone has:
 - Multiple connectivity chipsets are available on mobile devices, which could include a LC core
 - Multiple optical elements that are indicative of the devices that may be used for LC

LC offers significant market growth potential with over 550 million lights sold annually and 13% CAGR

- “The LiFi market is expected to grow to \$75.5 Billion by 2023 with CAGR of 80%.” – Global Market Insights, Inc.

- “The visible light communication market is expected to grow at a CAGR of 62.9% between 2017 and 2022, to reach USD 14.91 Billion by 2022 from USD 1.30 Billion in 2017.” – MarketsAndMarkets

- A possible 802.11 LC standard could be ready for 2021 with a likely market of over USD 10 Billion.

- Providing wired connectivity to lights is key for smart buildings with RF sensitive environments.
 - Machine condition monitoring market size was valued over USD 1.5 billion in 2014. It is likely to grow at over 7.5% and exceed USD 3 billion from 2016 to 2023. – Global Market Insight
 - Similarly restricted areas such as mining and Oil & Gas would increase the potential market value several times over.

Summary

Technology

- High-speed OWC enables superior mobile user performance
- 30 Tbit/s/km² are feasible with standard low-cost LEDs

Promising use cases

- Backhaul: Hybrid OWC and mm-wave
- Industrial wireless: Robustness through MIMO
- Public/private premises: Heterogeneous Wi-Fi and Li-Fi

New features may be needed for new use cases

- Dynamic rate adaptation and MIMO, heterogeneous Wi-Fi and OWC/LC
- Support for multiple users served by a network of small optical “hot-spots”

Summary

Market

Changes in the lighting industry as well as the communications industry present multiple market opportunities

802.15.7m

- Primary capability is to address use-cases for very low data rates that can be implemented using existing mobile phone cameras or very low data rate receivers

802.15.13

- Primary capability is to address use-cases for very high data rate requirements and complex systems that are designed to be specialty networks such as industrial wireless applications

Potential 802.11 LC

- The scope is yet to be determined by a Study Group.
- Clear differentiation exists with the other standardization efforts in the ability to address mass-market use-cases similar to existing Wi-Fi and provide a complementary communications channel with limited additional complexity and potential for channel bonding