

Workflow Discussion

Steve Zuponic

IEC/IEEE 60802

September 2021



Example: Blanking Line Application

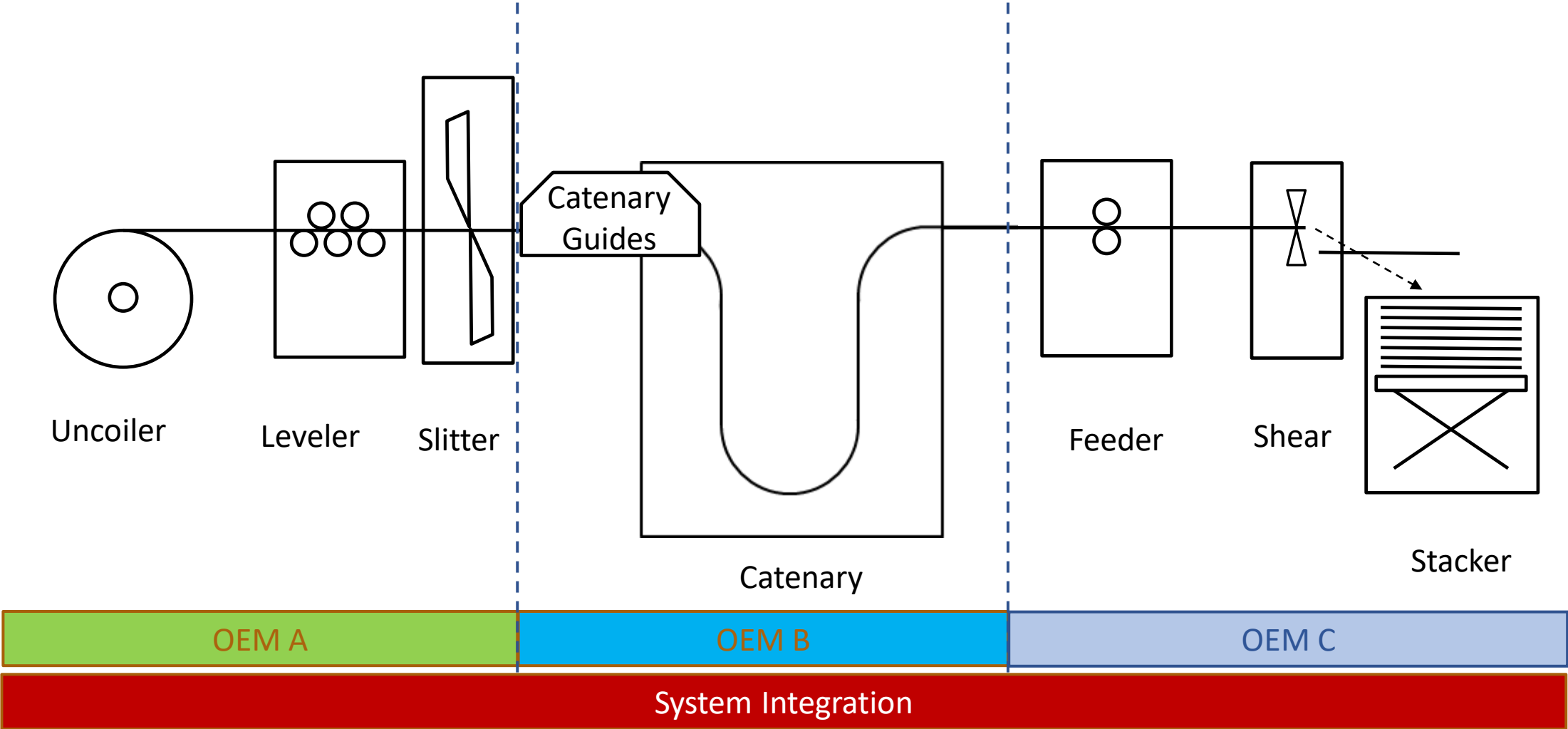

Architectural Segmentation: Subsystem Identification

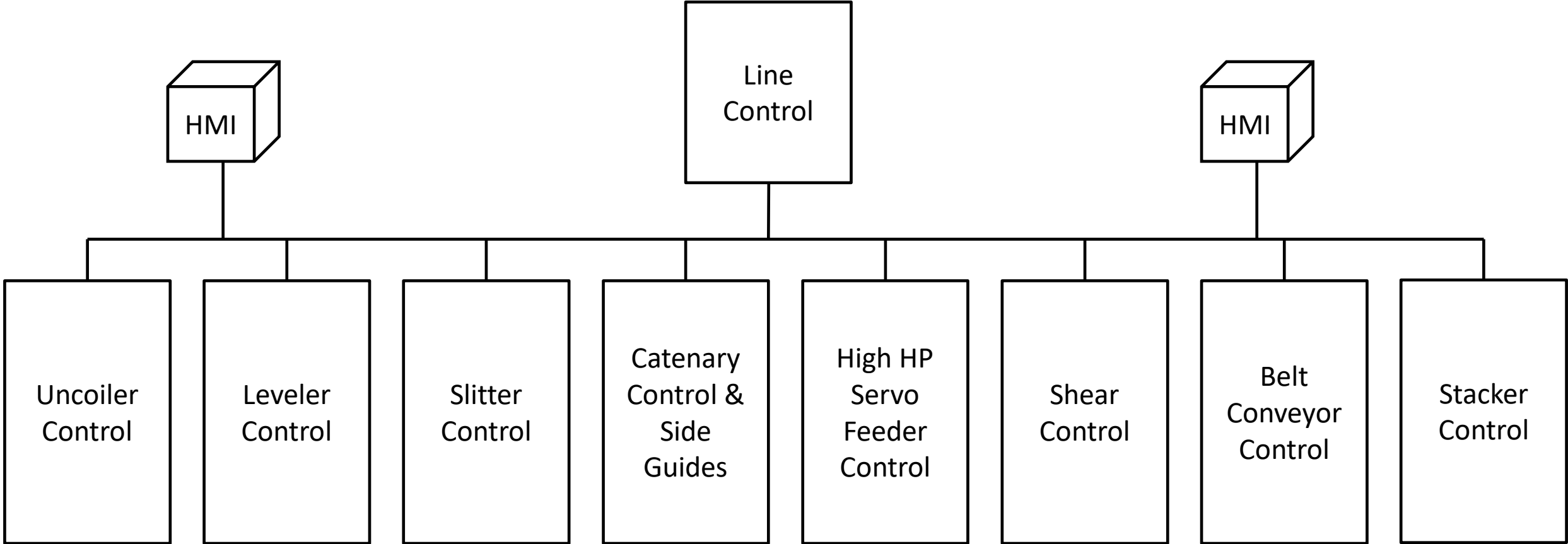

Workflow

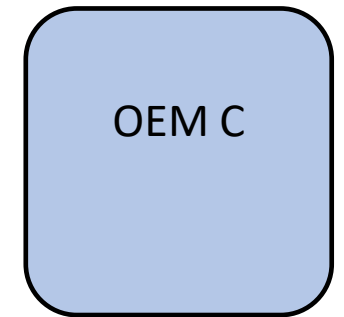
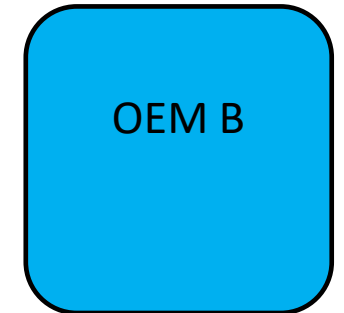
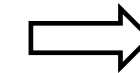
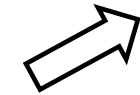
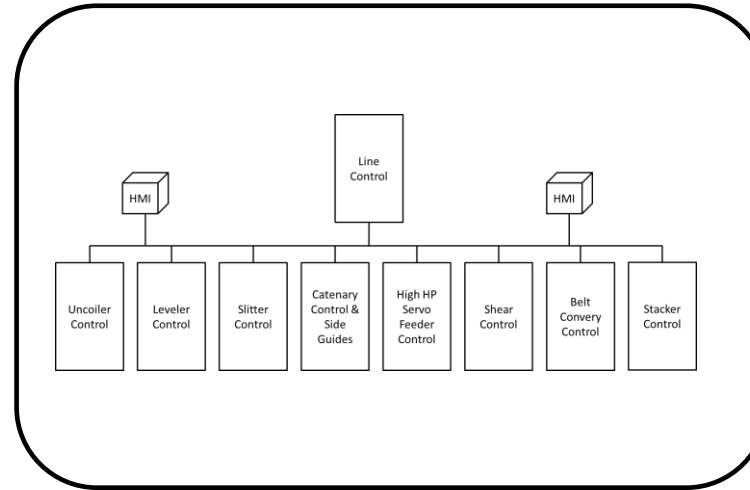
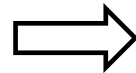
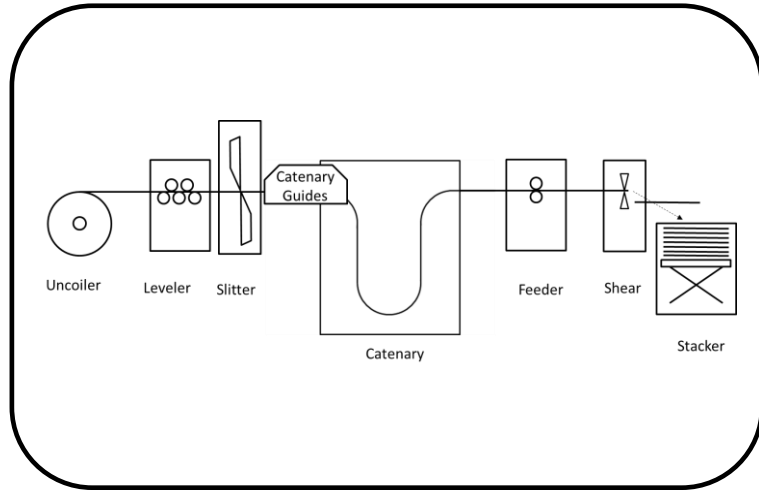

Offline Workflow

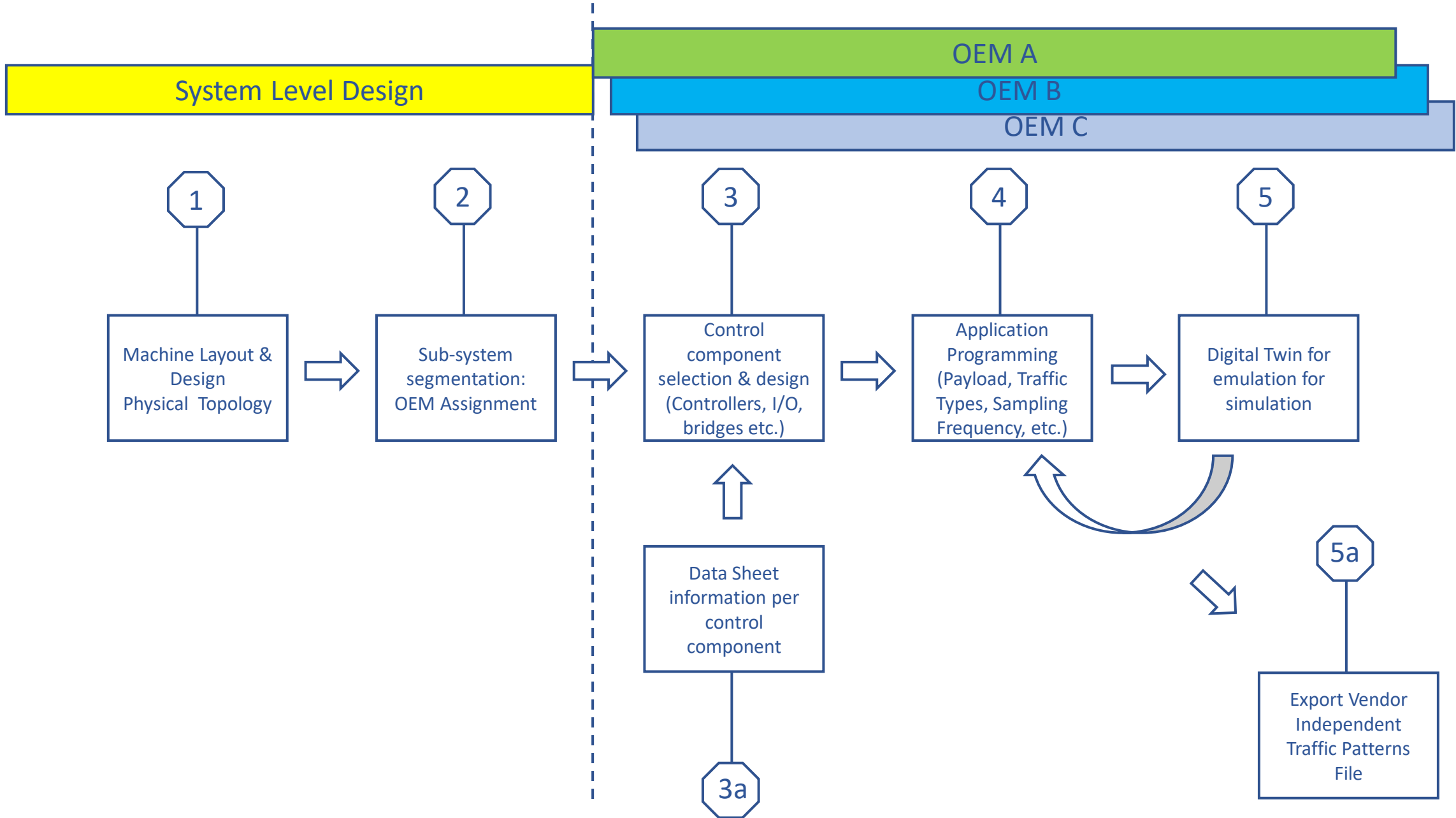

Online Workflow – OEM Sites

Local
Construction of
Subsystems at
OEM Sites

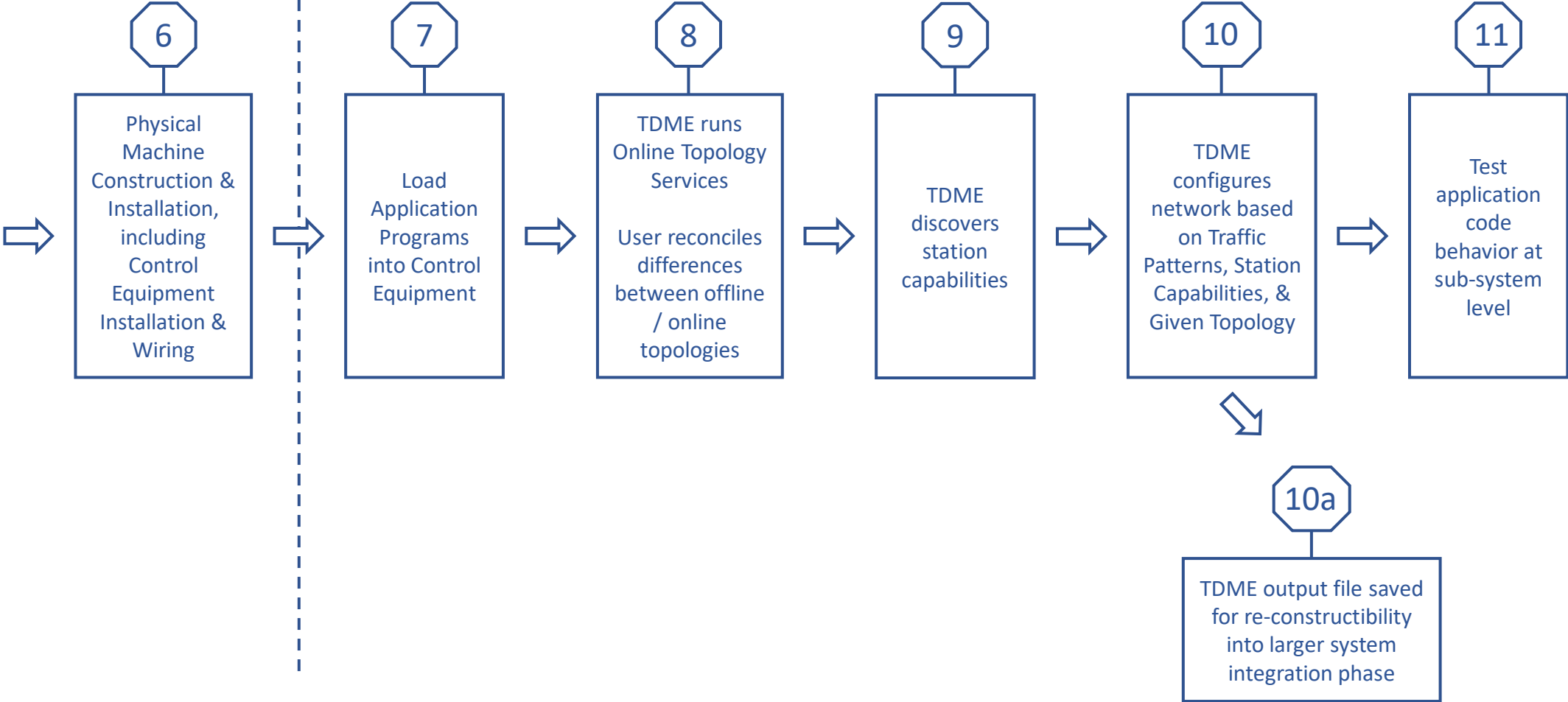
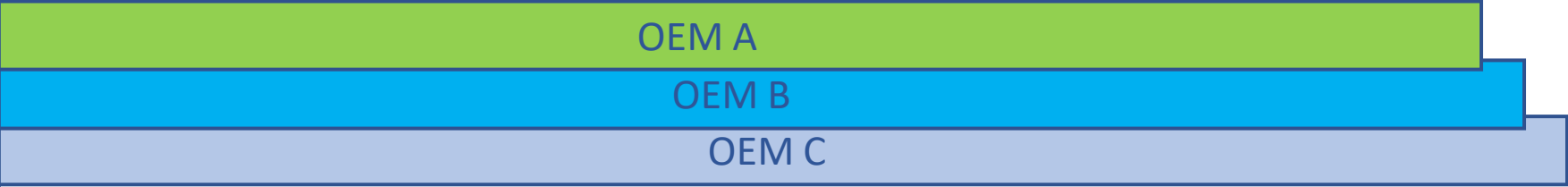

Online Workflow – End User Site

