IEEE P802.11
Wireless LANs

OFDM Physical Layer Specification for the 5 GHz Band

Hitoshi Takanashi Masahiro Morikura and Richard van Nee⁺
NTT Wireless Systems Labs. Lucent Technologies Bell Labs⁺

1. OFDM Physical Layer Specification for the 5 GHz Band**1.1. Introduction**

This clause describes the physical layer for the Orthogonal Frequency Division Multiplexing (OFDM) system. The Radio Frequency LAN system is initially aimed for the 5.15-5.25, 5.25-5.35 and 5.725-5.825 GHz U-NII bands as provided in the USA according to Document FCC 15.407.

The OFDM system provides a wireless LAN with data payload communication capabilities of 5, 10, 15, 20 and 30 Mbit/s. The system uses 48 subcarriers which are modulated using Binary or Quadrature Phase Shift Keying (BPSK/QPSK), or 16-Quadrature Amplitude Modulation (16-QAM). Forward error correction coding (convolutional coding) is used with a coding rate of 1/2 or 3/4.

1.1.1. Scope

This clause describes the physical layer services provided to the 802.11 wireless LAN MAC by the 5 GHz (bands) OFDM system. The OFDM PHY layer consists of two protocol functions:

- a) A physical layer convergence function which adapts the capabilities of the physical medium dependent system to the Physical Layer service. This function shall be supported by the Physical Layer Convergence Procedure (PLCP) which defines a method of mapping the 802.11 MAC sublayer Protocol Data Units (MPDU) into a framing format suitable for sending and receiving user data and management information between two or more stations using the associated physical medium dependent system.
- b) A Physical Medium Dependent (PMD) system whose function defines the characteristics and method of transmitting and receiving data through a wireless medium between two or more stations each using the OFDM system.

1.1.2. OFDM Physical Layer Functions

The 5 GHz OFDM PHY architecture is depicted in the reference model shown in Figure 11. The OFDM physical layer contains three functional entities: the physical medium dependent function, the physical layer convergence function and the layer management function. Each of these functions is described in detail in the following subclauses.

The OFDM Physical Layer service shall be provided to the Medium Access Control through the physical layer service primitives described in clause 12.

1.1.2.1. Physical Layer Convergence Procedure Sublayer

In order to allow the 802.11 MAC to operate with minimum dependence on the PMD sublayer, a physical layer convergence sublayer is defined. This function simplifies the physical layer service interface to the 802.11 MAC services.

1.1.2.2. Physical Medium Dependent Sublayer

The physical medium dependent sublayer provides a means to send and receive data between two or more stations. This clause is concerned with the 5 GHz band using OFDM.

1.1.2.3. Physical Layer Management Entity (LME)

The Physical LME performs management of the local Physical Layer Functions in conjunction with the MAC Management entity.

1.1.2.4. Service Specification Method and Notation

The models represented by figures and state diagrams are intended to be illustrations of the functions provided. It is important to distinguish between a model and a real implementation. The models are optimized for simplicity and clarity of presentation, the actual method of implementation is left to the discretion of the 802.11 OFDM PHY compliant developer.

The service of a layer or sublayer is the set of capabilities that it offers to a user in the next higher layer (or sublayer). Abstract services are specified here by describing the service primitives and parameters that characterize each service. This definition is independent of any particular implementation.

1.2. OFDM PHY Specific Service Parameter Lists

1.2.1. Introduction

The architecture of the 802.11 MAC is intended to be physical layer independent. Some physical layer implementations require medium management state machines running in the medium access control sublayer in order to meet certain PMD requirements. These physical layer dependent MAC state machines reside in a sublayer defined as the MAC subLayer Management Entity (MLME). The MLME in certain PMD implementations may need to interact with the Physical LME (PLME) as part of the normal PHY SAP primitives. These interactions are defined by the Physical Layer Management Entity parameter list currently defined in the PHY Service Primitives as TXVECTOR and RXVECTOR. The list of these parameters and the values they may represent are defined in the specific physical layer specifications for each PMD. This subclause addresses the TXVECTOR and RXVECTOR for the OFDM PHY.

1.2.2. TXVECTOR Parameters

The following parameters are defined as part of the TXVECTOR parameter list in the PHY-TXSTART.request service primitive.

Parameter	Associate Primitive	Value
LENGTH	PHY-TXSTART.request (TXVECTOR)	1-65535
DATARATE	PHY-TXSTART.request (TXVECTOR)	30, 20, 15, 10 and 5
SERVICE	PHY-TXSTART.request (TXVECTOR)	Null
TXPWR_LEVEL	PHY-TXSTART.request (TXVECTOR)	1-8

Table 75, TXVECTOR Parameters

1.2.2.1. TXVECTOR LENGTH

The LENGTH parameter has the value from 1 to 65535. This parameter is used to indicate the number of octets in the MPDU which the MAC is currently requesting the PHY to transmit. This value is used by the PHY to determine the number of octet transfers which will occur between the MAC and the PHY after receiving a request to start the transmission.

1.2.2.2. TXVECTOR DATARATE

The DATARATE parameter describes the bit rate at which the PLCP should transmit the PSDU. Its value can be any of the rates as defined in Table 75, TXVECTOR Parameters, and supported by the OFDM PHY.

1.2.2.3. TXVECTOR SERVICE

The SERVICE parameter should be reserved for future use.

1.2.2.4. TXVECTOR TXPWR_LEVEL

The TXPWR_LEVEL parameter has the value from 1 to 8. This parameter is used to indicate the number of TxPowerLevel attributes defined in the MIB for the current MPDU transmission.

1.2.3. RXVECTOR Parameters

The following parameters are defined as part of the RXVECTOR parameter list in the PHY-RXSTART.indicate service primitive.

Parameter	Associate Primitive	Value
LENGTH	PHY-RXSTART.indicate (RXVECTOR)	1-65535
RSSI	PHY-RXSTART.indicate (RXVECTOR)	0 - RSSI Max
DATARATE	PHY-RXSTART.request (RXVECTOR)	30, 20, 15, 10 and 5
SERVICE	PHY-RXSTART.request (RXVECTOR)	null

Table 76, RXVECTOR Parameters

1.2.3.1. RXVECTOR LENGTH

The LENGTH parameter has the value from 1 to 65535. This parameter is used to indicate the value contained in the LENGTH field which the PLCP has received in the PLCP Header. The MAC and PLCP will use this value to determine the number of octet transfers that will occur between the two sublayers during the transfer of the received PSDU.

1.2.3.2. RXVECTOR RSSI

The Receive Signal Strength Indicator (RSSI) is a parameter takes a value from 0 through RSSI Max. This parameter is a measure by the PHY sublayer of the energy observed at the antenna used to receive the current PPDU. RSSI shall be measured during the reception of the PLCP Preamble. RSSI is intended to be used in a relative manner. Absolute accuracy of the RSSI reading is not specified..

1.3. OFDM Physical Layer Convergence Procedure Sublayer

1.3.1. Introduction

This clause provides a convergence procedure in which MPDUs are converted to and from PPDUs. During transmission, the MPDU shall be provided with a PLCP preamble and header to create the PPDU. At the receiver, the PLCP preamble and header are processed to aid in demodulation and delivery of the MPDU.

1.3.2. Physical Layer Convergence Procedure Frame Format

Figure 107 shows the format for the PPDU including the OFDM PLCP preamble, the OFDM PLCP header and the MPDU. The PLCP preamble contains the Synchronization (SYNC). The PLCP header contains the following fields: signaling (SIGNAL), service (SERVICE), length (LENGTH), and CCITT CRC-16. Each of these fields is described in detail in clause 1.3.3.

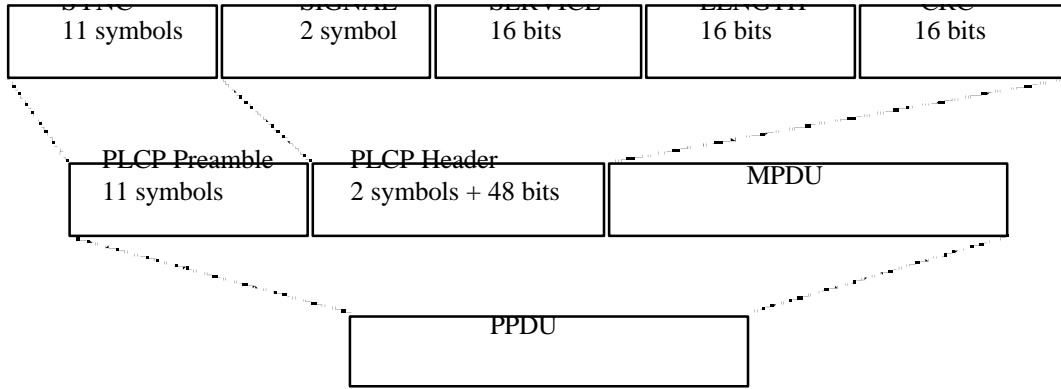

Figure 107, PLCP Frame Format

1.3.3. PLCP Field Definitions

The SYNC field consists of 9 short symbols as defined in 1.3.3.1 and 2 long symbols that are shown in Figure 108 and described in 1.3.3.1. The SIGNAL fields consists of two short symbols that indicates the type of base band modulation and coding rate as described in 1.3.3.2. All transmitted bits except for PLCP preamble and SIGNAL field shall be scrambled using the scrambler described in clause 1.3.5. and encoded using the convolutional encoder described in clause 1.3.3.6. The OFDM symbol starts at the SERVICE field. The entire PLCP preamble and header shall be transmitted using the 20 Mbit/s DQPSK-OFDM modulation (uncoded) described in clause 1.5.6.5. All transmitted bits except for PLCP preamble and SIGNAL shall be scrambled using the feedthrough scrambler described in clause 1.3.5. and encoded using the convolutional encoder described in clause 1.3.3.6.

1.3.3.1. PLCP Synchronization (SYNC)

The synchronization field consists of short and long OFDM training symbols.

A short OFDM training symbol consists of 12 subcarriers, which are phase modulated by the elements of the sequence *S*, given by:

$$S=2*\{0\ 0\ 1+j\ 0\ 0\ 0\ -1+j\ 0\ 0\ 0\ 1+j\ 0\ 0\ 0\ -1-j\ 0\ 0\ 0\ -1-j\ 0\ 0\ 0\ 1+j\ 0\ 0\ 0\ -1-j\ 0\ 0\ 0\ 1-j\ 0\ 0\ 0\ -1-j\ 0\ 0\ 0\ -1-j\ 0\ 0\ 0\ -1-j\ 0\ 0\ 0\ 1+j\ 0\ 0\ 0\}$$

(1)

The multiplication by a factor of 2 is in order to normalize the average power of the resulting OFDM symbol.

By applying a 64-point IFFT to the vector *S* – where the remaining 15 values are set to zero - four short training symbols can be produced.

For one short training symbol starting at $t=t_s$, the signal can be written as:

$$r_t(t) = \text{Re} \left\{ w_t(t-t_s) \sum_{\substack{j=-\frac{N_s}{2} \\ j \neq 0}}^{\frac{N_s}{2}} S_{j+\frac{N_s}{2}} \exp(j2\pi(f_c - \frac{j}{T})(t-t_s - \frac{bT}{2})) \right\}, \quad t_s \leq t \leq t_s + T_t + bT \quad (2)$$

$$r_t(t) = 0, \quad t < t_s \wedge t > t_s + T_t + bT$$

The symbol interval T_t is exactly 1/4 of the FFT duration T of a data symbol, which is equal to $((64/76)/4) \cdot 4.8 \mu s$, or approximately 1.01 μs .

The training symbols are windowed by the window function $w_t(t)$ to ensure a sharp spectrum roll-off outside the

band.

$$w_t(t) = \begin{cases} 0.5 + 0.5 \cos\left(\pi\left(p + \frac{tp}{bT}\right)\right) & 0 \leq t \leq bT \\ 1.0 & bT \leq t \leq T_t \\ 0.5 + 0.5 \cos\left(\pi\left(\frac{(t - T_t)p}{bT}\right)\right) & T_t \leq t \leq T_t + bT \end{cases} \quad (3)$$

A long OFDM training symbol consists of 48 subcarriers, which are phase modulated by the elements of the sequence K , given by:

$$K = \{1+j, -1+j, 1+j, 1+j, 1+j, -1-j, 1+j, -1+j, 1+j, -1-j, -1-j, 1+j, 1+j, -1+j, 1+j, 1+j, -1-j, -1-j, 1-j, -1-j, 1+j, 1+j, -1-j, 0, -1+j, 1+j, 1+j, 1+j, -1-j, 1+j, -1+j, 1+j, -1-j, -1-j, 1+j, -1-j, 1-j, -1-j, -1-j, 1+j, 1+j, -1+j, 1+j, -1-j, -1-j, 1+j, 1+j\} \quad (4)$$

The 48 elements of K are used to phase rotate 48 OFDM subcarriers. A long OFDM training symbol can be written in the same way as an OFDM data symbol (7), with d_i replaced by $K_{i+N_s/2}$.

Figure 108 shows the OFDM training structure, where t_1 to t_{11} denote short training symbols and T1 and T2 are long training symbols. The total training length is 20.6 μ s, including the SIGNAL field, which indicates the type of coding and modulation used in the OFDM data symbols.

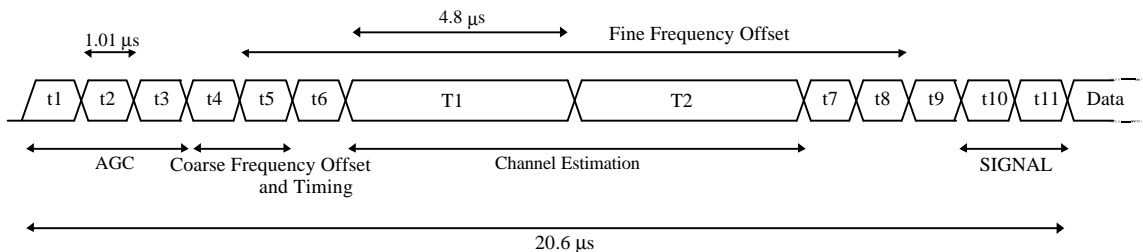

Figure 108, Training Structure

1.3.3.2. Signal Field (SIGNAL)

At the end of the OFDM training, two short OFDM training symbols are sent which contain information about the type of modulation and the coding rate as used in the rest of the packet. A total of 4 bits are encoded by using QPSK on the entire short training symbol, so all subcarriers are modulated by the same phase. Table lists the contents of the Signal field, with the corresponding QPSK phases between brackets.

coding rate		3/4	1/2
16 QAM	Data Rate	30 Mbit/s	20 Mbit/s
	Signal Field	10 10	10 01
DQPSK	Data Rate	15 Mbit/s	10 Mbit/s
	Signal Field	01 10	01 01
DBPSK	Data Rate		5 Mbit/s
	Signal Field		00 01

Table 77, Contents of Signal Field

1.3.3.3. PLCP 802.11 Service Field (SERVICE)

The first 7 bits of the service field are used to synchronize the descrambler. The remaining 8 bit 802.11 service field shall be reserved for future use. The value of 00h signifies 802.11 device compliance. The LSB shall be transmitted first in time. This field shall be protected by the CCITT CRC-16 frame check sequence described in clause 1.3.3.5.

1.3.3.4. PLCP Length Field (LENGTH)

The PLCP length field shall be an unsigned 16 bit integer which indicates the number of octets in the MPDU which the MAC is currently requesting the PHY to transmit. This value is used by the PHY to determine the number of octet transfers that will occur between the MAC and the PHY after receiving a request to start transmission. The transmitted value shall be determined from the LENGTH parameter in the TXVECTOR issued with the PHY-TXSTART.request primitive described in clause 12.3.5.4. The LSB (least significant bit) shall be transmitted first in time. This field shall be protected by the CCITT CRC-16 frame check sequence described in clause 1.3.3.5. This field shall be encoded by the convolutional encoder described in clause 1.3.3.8.

1.3.3.5. PLCP CRC Field (CCITT CRC-16)

The 802.11 SIGNAL, 802.11 SERVICE, and LENGTH fields shall be protected with a CCITT CRC-16 FCS (frame check sequence). The CCITT CRC-16 FCS shall be the ones complement of the remainder generated by modulo 2 division of the protected PLCP fields by the polynomial:

$$x^{16} + x^{12} + x^5 + 1 \quad (5)$$

The protected bits shall be processed in transmit order. All FCS calculations shall be made prior to data scrambling. This is shown in Figure 109.

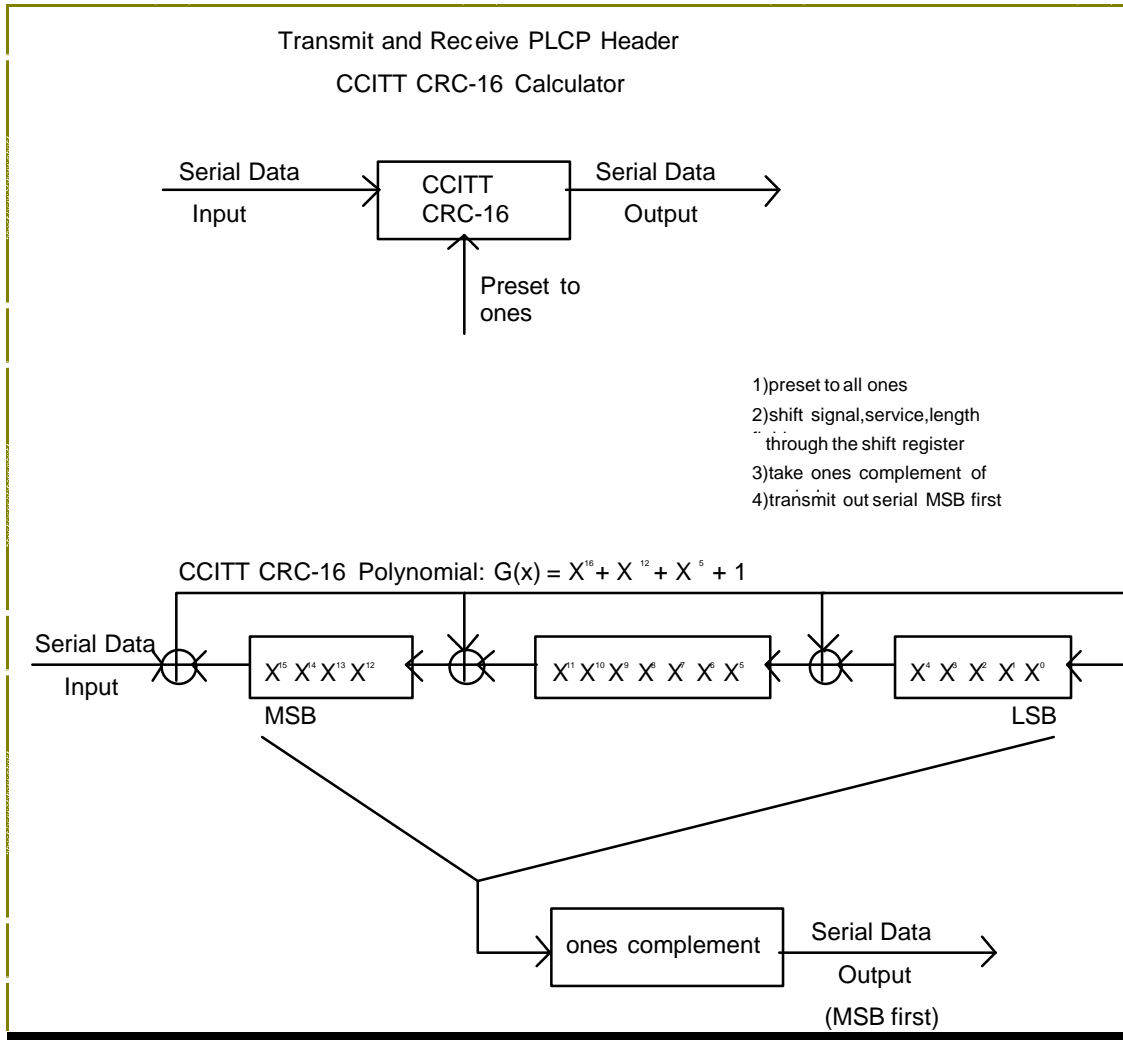

Figure 109, CCITT CRC-16 Implementation

1.3.3.6. PLCP / OFDM PHY Data Scrambler and Descrambler

The PLCP data scrambler/descrambler uses a length-127 frame-synchronous scrambler. Data octets are placed in the transmit serial bit stream LSB first and MSB last. The frame synchronous scrambler uses the generator polynomial $S(x)$ as follows:

$$S(x) = x^7 + x^4 + 1$$

and is illustrated in 112. The 127-bit sequence generated repeatedly by the scrambler is (leftmost used first) 00001110 11110010 11001001 00000010 00100110 00101110 10110110 00001100 11010100 11100111 10110100 00101010 11111010 01010001 10111000 11111111. The same scrambler is used to scramble transmit data and to descramble receive data. When transmitting, the initial state of the scrambler will be set to a random non-zero state. The first byte of the SERVICE field will be set to all zeros prior to scrambling in order to enable estimation of the initial state of the scrambler in the receiver.

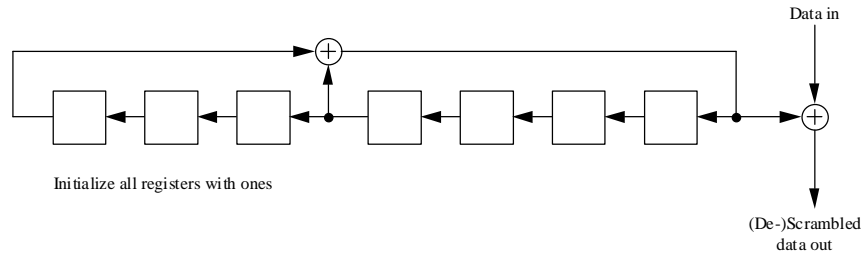

Figure 110, Data Scrambler

The polynomial $G(z) = z^{-7} + z^{-4} + 1$ shall be used to scramble all bits transmitted by the OFDM PHY, starting from the SERVICE field in the PLCP header. The feedthrough configuration of the scrambler and descrambler is self synchronizing which requires no prior knowledge of the transmitter initialization of the scrambler for receive processing. Figure 110 and Figure 111 show typical implementations of the data scrambler and descrambler. Other implementations are possible.

The scrambler should be initialized to any state except all ones when transmitting. The first 7 output bits are used at the receiver to synchronize the descrambler.

Scrambler Polynomial; $G(z) = Z^{-7} + Z^{-4} + 1$

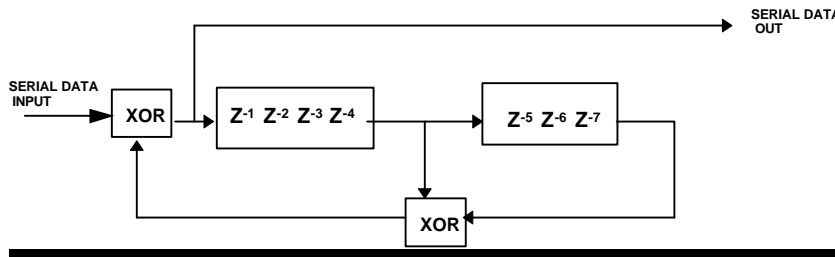

Figure 110, Data Scrambler

Descrambler Polynomial; $G(z) = Z^{-7} + Z^{-4} + 1$

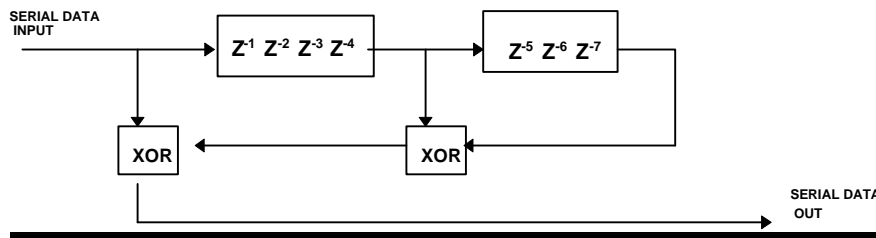

Figure 111, Data Descrambler

1.3.3.7. PLCP Tail Bit Field (TAIL)

The PLCP tail bit field shall be 8 bits of '0' which is required for the convolutional code to decode certainly at the end of each packet. The PLCP tail bit field shall not be scrambled. The MPDU and this field shall be encoded to C-MPDU by convolutional encoder.

1.3.3.8. Convolutional encoder

The 802.11 SIGNAL, SERVICE, LENGTH, CRC and MPDU shall be coded with a convolutional encoder of $r=1/2$

as shown in Figure 111. The encoded two bits out of six bits shall be stolen in order to change the coding rate to 3/4 (punctured). This bit stealing procedure is described in Figure 113. As the figure shows, three bits of the source data are encoded to six bits by the encoder and two of the six bits are taken out by the bit-stealing function. In the reception, the stolen bits are substituted by dummy bits. Decoding by the Viterbi algorithm is recommended.

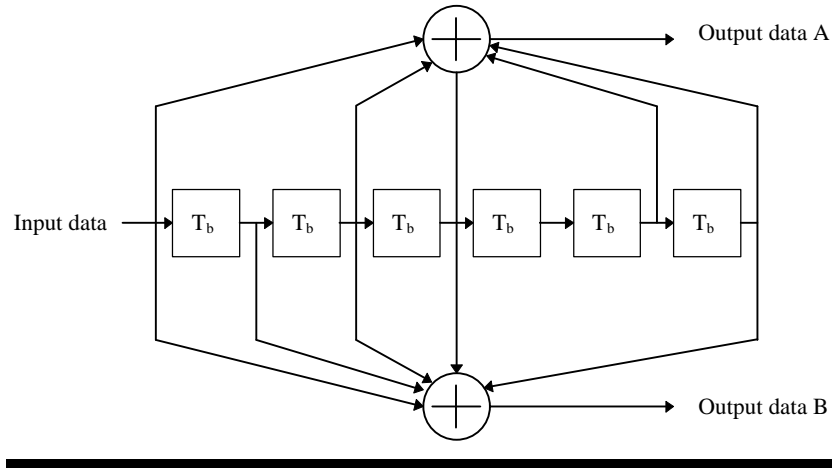

Figure 111, Convolutional Encoder

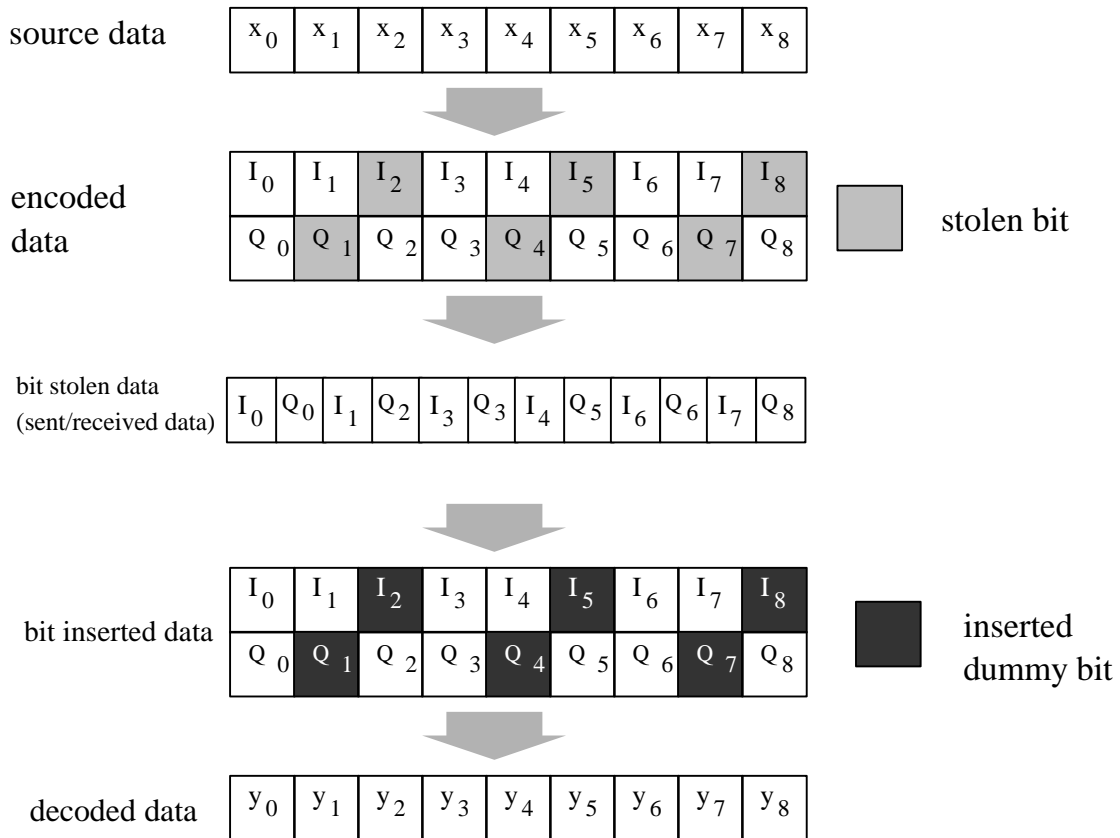

Figure 112, An example of bit-stealing and bit-insertion procedure ($r=3/4$)

1.3.3.9. Bit stuff

The coded MPDU length shall be multiples of an OFDM symbol (192, 96 or 48 bits). In case the coded MPDU length is not a multiple of bits in one OFDM symbol, appropriate length bits are stuffed by any bits in order to make the length a multiple of bits in one OFDM symbol.

1.3.4. Clear Channel Assessment (CCA)

PLCP shall provide the capability to perform CCA and report the result to the MAC. CCA shall report a busy medium (frequency) upon detecting the RSSI, which is reported by the primitive PMD_RSSI.indicate, above the TThreshold which is given by “aTThreshold”. This medium status report is indicated by the primitive PHY_CCA.indicate.

1.3.5. PLCP Data Modulation and Modulation Rate Change

The PLCP preamble shall be transmitted using the uncoded 20 Mbit/s DQPSK-OFDM modulation. The 802.11 SIGNAL field shall indicate the modulation and coding rate that shall be used to transmit the MPDU. The transmitter and receiver shall initiate the modulation, demodulation and the coding rate indicated by the 802.11 SIGNAL field. The MPDU transmission rate shall be set by the DATARATE parameter in the TXVECTOR issued with the PHY-TXSTART.request primitive described in clause 1.2.2.

1.3.6. PMD Operating Specifications General

The following clauses provide general specifications for the 16-QAM-OFDM, DQPSK-OFDM and DBPSK-OFDM Physical Medium Dependent sublayer. These specifications apply to both the receive and the transmit functions and general operation of the OFDM PHY.

1.3.6.1. Outline description

The general block diagram of transmitter and receiver for the OFDM PHY is shown in Figure 113. Major specifications for OFDM PHY are listed in Table 78.

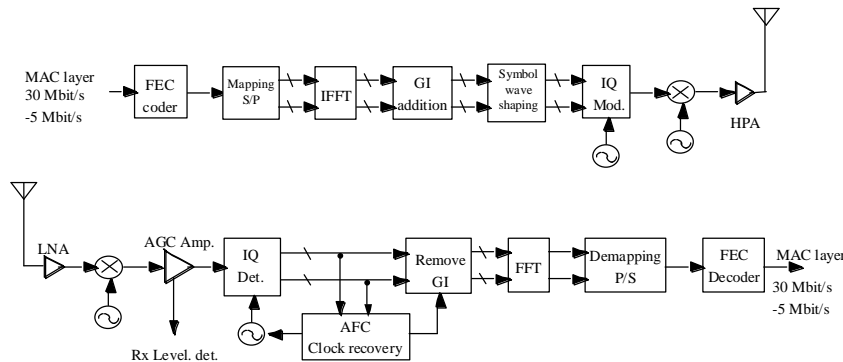

Figure 113, An Example of Transmitter and Receiver Block Diagram for OFDM PHY

Information data rate	30, 20, 15, 10 and 5 Mbit/s
Modulation	16-QAM-OFDM DQPSK-OFDM DBPSK-OFDM
Coding rate	3/4, 1/2
Number of subcarriers	48
OFDM symbol duration	4.8 μs
Guard interval	0.758 μs * (T _{GI} + T _{prefix} + T _{postfix})
Occupied Bandwidth	12 MHz

(* Refer to clause 1.5.6.5)

Table 78, OFDM PHY Major Parameters of OFDM PHY

1.3.6.2. Operating Frequency Range

The OFDM PHY shall operate in the frequency ranges of 5.15 to 5.35 and 5.725 to 5.825 GHz as allocated by regulatory bodies in the USA and Europe.

1.3.6.3. Operating Frequency Range

The OFDM PHY shall operate in the 5 GHz band as allocated by regulatory bodies in the USA and Europe.

1.3.6.4. Channelization

Figure 114 shows a channelization scheme for a total bandwidth of 100 MHz. Five channels can be accommodated for an out-of-band spectral density that shall meet the local regulation. A guard band of 13.875 MHz is secured at the both ends. The outer channels may have to be amplified by an HPA which has more backoff than the inner channels. This issue depends on the local regulation and HPA characteristics.

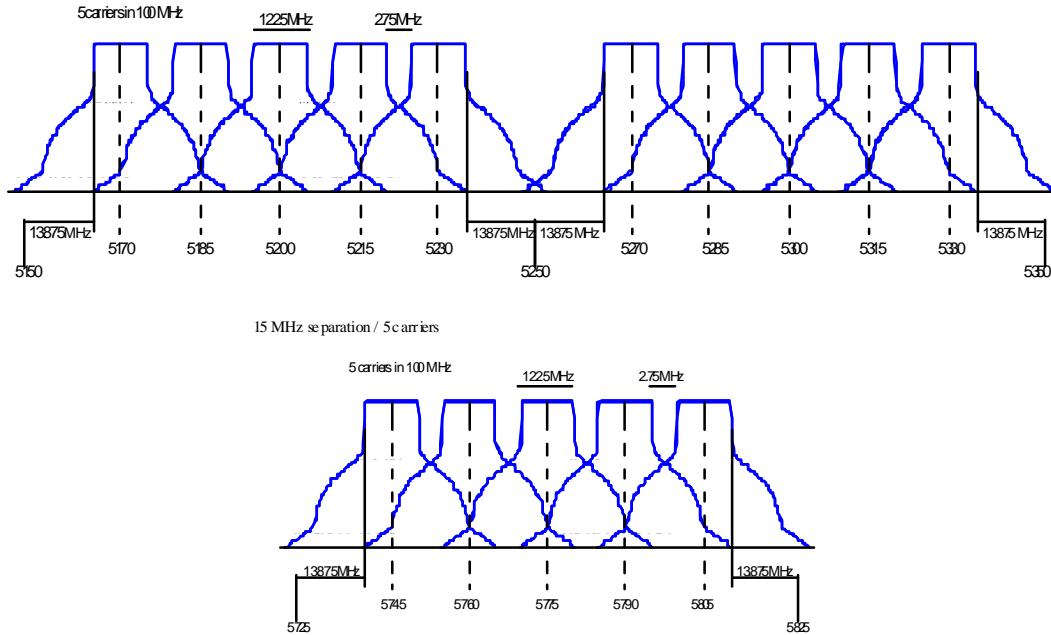

Figure 114, OFDM PHY Frequency Channel Plan

In Figure 114, however, the center frequency is indicated, no subcarrier is allocated on the center frequency as described in Figure 115.

In a multiple cell network topology, overlapping and/or adjacent cells using different channels can operate simultaneously.

1.3.6.5. Data Interleaving

All encoded data bits shall be interleaved with an interleaving depth of one OFDM symbol. This means that the interleaving depth is 48, 96 or 192 bits for DBPSK, DQPSK and 16-QAM, respectively. For the various interleaving depths d , the i th interleaved bit at each OFDM symbol is equal to the k th encoded input bit, where k is given by:

$$k = 8i - (d-1)\text{floor}(8i/d) \quad i=0,1, \dots, d-1 \tag{6}$$

1.3.6.6. Modulation

The OFDM subcarriers can be modulated by using phase shift keying or Quadrature amplitude modulation. Binary input data is converted into DBPSK, DQPSK, or 16-QAM, according to Gray code mappings, which are listed in the following tables:

bit x_k	Phase ϕ_k	I Q
0	0	1 1

1	$+\pi$ ($-\pi$)	-1 -1
---	-------------------	-------

Table 79, BPSK Encoding Table of k_{th} Subcarrier

Dibit pattern (x_k, y_k) x_k is first in time	Phase j_k	I Q
00	0	1 1
01	$\pi/2$	-1 1
11	π	-1 -1
10	$3\pi/2$ ($-\pi/2$)	1 -1

Table 80, QPSK Encoding Table of k_{th} Subcarrier

The differential encoding is performed by

$$j_{i,k} = (j_{i,k} + j_{i-1,k}) \text{ mod } 2p \tag{7}$$

where subscript i means OFDM symbol number i , subscript k means k_{th} subcarrier.

Input data	I-out	Q-out
1010	3	3
1011	3	1
1001	3	-1
1000	3	-3
1110	1	3
1111	1	1
1101	1	-1
1100	1	-3
0110	-1	3
0111	-1	1
0101	-1	-1
0100	-1	-3
0010	-3	3
0011	-3	1
0001	-3	-1
0000	-3	-3

Table 81, 16-QAM Encoding Table

Notice the I/Q values are not normalized; in practice, all mappings should have the same average power, which is possible by dividing all values by the average constellation power. This average power is given in Table 82. The exact way in which the normalization is done is left to the manufacturer.

BPSK	$\sqrt{2}$
QPSK	$\sqrt{2}$
16-QAM	$\sqrt{10}$

Table 82, Average Power of Constellations

Three of the subcarriers are dedicated to pilot signals in order to make the coherent detection robust against frequency offsets and phase noise. These pilot signals are put in subcarrier #3, 26 and 47 with values of $\{1+j, 1+j, -1-j\}$ respectively. The data supposed to be sent on these subcarriers are stolen and punctured.

Starting at time $t=t_s$, an OFDM symbol $r_k(t)$ is defined as:

$$r_k(t) = \text{Re} \left\{ w(t-t_s) \sum_{\substack{i=1 \\ i \neq 0}}^{\frac{N_s}{2}} d_{i+(N_s+1)(k+1/2)} \exp(j2\pi(f_c - \frac{i}{T})(t-t_s - T_{\text{prefix}})) \right\}, \quad t_s \leq t \leq t_s + T + T_{\text{prefix}} + T_{\text{postfix}}$$

$$r_k(t) = 0, \quad t < t_s \wedge t > t_s + T + T_{\text{prefix}} + T_{\text{postfix}}$$

(7)

The subcarrier frequency allocation is shown in Figure 115. To avoid difficulties in D/A and A/D converter offsets and carrier feedthrough in the RF system, the subcarrier falling at D.C. ($n = 0$) is not used.

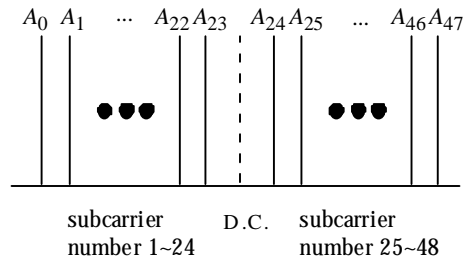

Figure 115, Subcarrier Frequency Allocation

A packet of K OFDM symbols can now be written as:

$$r(t) = \sum_{k=0}^K r_k(t - kT_s) \tag{8}$$

In (7), d_i is the i th QAM value, which is obtained by mapping input bits according to the method described in 1.3.6.6.

$w(t)$ is the raised cosine pulse shaping function with a roll-off factor b of 0.025. It is defined as:

$$w(t) = \begin{cases} 0.5 + 0.5 \cos\left(\pi + \frac{t-p}{bT}\right) & 0 \leq t \leq bT \\ 1.0 & bT \leq t \leq T_s \\ 0.5 + 0.5 \cos\left(\frac{(t-T_s)p}{bT}\right) & T_s \leq t \leq T_s + bT \end{cases} \tag{9}$$

The OFDM signal can be generated as follows: first, groups of 48 data symbols d_i are padded with zeros to get blocks of 64 input samples which are used to calculate an Inverse Fast Fourier Transform (IFFT). Then, the last T_{prefix} samples of the IFFT output are inserted at the start of the OFDM symbol, and the first T_{postfix} samples are appended at the end. The OFDM symbol is then multiplied by a raised cosine window $w(t)$ to reduce the power of out-of-band subcarriers. The OFDM symbol is then added to the output of the previous OFDM symbol with a delay of T_s , such that there is an overlap region of $b T_s$, where b is the roll-off factor of the raised cosine window. The time structure of OFDM symbols is depicted in Figure 116. Relevant OFDM parameters are listed in Table 83.

Figure 116: OFDM cyclic extension and windowing.

N_s	: Number of subcarriers	48
T_s	: Symbol interval	4.8 μ s
T	: IFFT/FFT period	4.042 μ s ($T_s \cdot 64/76$)
T_G	: Guard time	758 ns ($T_s - T$)
T_{prefix}	: Pre-guard interval	758 ns ($T_s - T$)
$T_{postfix}$: Post-guard interval	101 ns ($0.025T$)
b	: Roll-off factor	0.025

Table 83, OFDM parameters

1.3.6.7. Transmit and Receive In Band and Out of Band Spurious Emissions

The OFDM PHY shall conform to in-band and out-of-band spurious emissions as set by regulatory bodies. For the USA, refer to FCC 15.407.

1.3.6.8. TX RF Delay

The TX RF Delay time shall be defined as the time between the issuance of a PMD.DATA.request to the PMD and the start of the corresponding symbol at the air interface.

1.3.6.9. Slot Time

The slot time for the OFDM PHY shall be 6 μ s, which is the sum of the RX to TX turnaround time, MAC processing delay and the RSSI detect time (<4 μ s). The propagation delay shall be regarded as being included in the RSSI detect time.

1.3.6.10. Transmit and Receive Antenna Port Impedance

The transmit and receive antenna port(s) impedance shall be 50 Ω if the port is exposed.

1.3.6.11. Transmit and Receive Operating Temperature Range

Three temperature ranges for full operation compliance to the OFDM PHY are specified in clause 13. Type 1, defined as 0°C to 40°C, is designated for office environments. Type 2, defined as -20°C to +50°C, and Type 3, defined as -30°C to +70°C, are designated for industrial environments.

1.3.7. PMD Transmit Specifications

The following portion of these subclauses describes the transmit specifications associated with the Physical Medium Dependent sublayer. In general, these are specified by primitives from the PLCP and the Transmit PMD entity provides the actual means by which the signals required by the PLCP primitives are imposed onto the medium.

1.3.7.1. Transmit Power Levels

The maximum allowable output power according to FCC regulation is shown in Table 84.

Frequency Band	Maximum Output Power with up to 6 dBi antenna gain
5.15 - 5.25 GHz	30 mW (2.5 mW/MHz)
5.25 - 5.35 GHz	150 mW (12.5 mW/MHz)
5.725 - 5.825 GHz	600 mW (50 mW/MHz)

Table 84, Transmit Power Levels

1.3.7.2. Transmit Spectrum Mask

The transmitted spectrum shall have a -20 dBr (dB relative to the spectral density at the carrier frequency) bandwidth not exceeding 20 MHz. The transmitted spectral density of the transmitted signal shall fall within the spectral mask as shown in Figure 117. The measurements shall be made using 100 kHz resolution bandwidth and a 30 kHz video bandwidth.

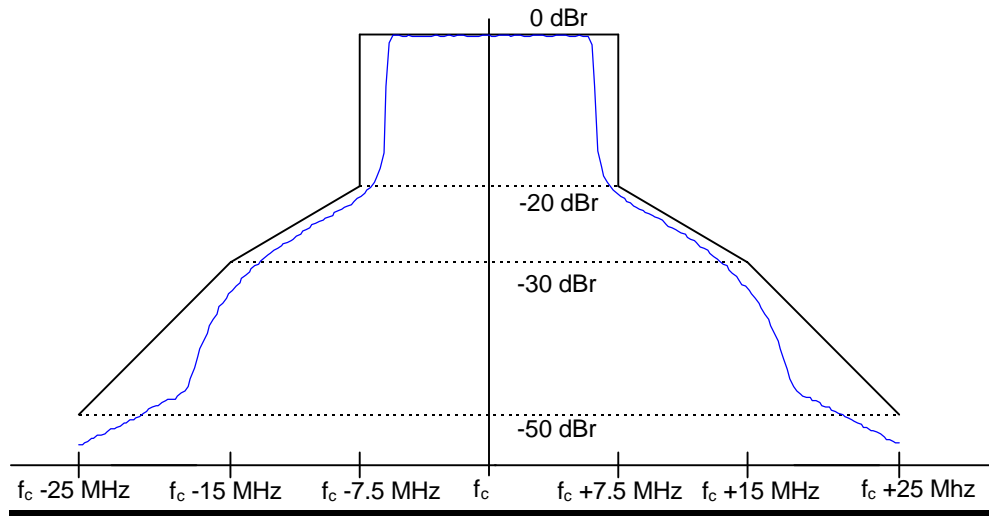

Figure 117, Transmit Spectrum Mask

1.3.7.3. Transmission Spurious

The transmission spurious from compliant device shall conform to the local geographic regulations.

1.3.7.4. Transmit Center Frequency Tolerance

The transmitted center frequency tolerance shall be +/- 40 ppm maximum. The symbol clock and carrier frequency have to be derived from the same reference clock to facilitate timing.

1.3.7.5. Transmit Modulation Accuracy

It is the actual value of the error of the signal point vector (the square root of the result of dividing the sum of the squares of the errors of the signal point vectors by the number of phase identification points within the frame). It shall be measured when only one OFDM subcarrier is used and no other subcarriers are used. It is to be 10.0 % or less.

1.3.7.6. Symbol Clock Frequency Tolerance

The symbol clock frequency tolerance shall be better than +/- 40 ppm maximum.

1.3.8. PMD Receiver Specifications

The following clauses describe the receive specifications associated with the Physical Medium Dependent sublayer.

1.3.8.1. Receiver Minimum Input Level Sensitivity

The Packet Error Rate (PER) shall be less than 10% at an MPDU length of 1000 bytes for an input level of -77 -72 dBm for 30 Mbit/s, -81 -76 dBm for 20 Mbit/s, -83 -78 dBm for 15 Mbit/s, -86 -81 dBm for 10 Mbit/s and -89 -84 dBm for 5 Mbit/s measured at the antenna connector. (Nf of 10 dB and 5 dB implementation margins are assumed)

1.3.8.2. Receiver Maximum Input Level

The receiver shall provide a maximum PER of 10% at an MPDU length of 1000 bytes for a maximum input level of -25 dBm measured at the antenna.

1.3.8.3. Receiver Adjacent Channel Rejection

Adjacent channel rejection is defined between any two channels that located next to each other.

The adjacent channel rejection shall be equal to or better than 11 dB for 30 Mbit/s, 15 dB for 20 Mbit/s, 17 dB for 15 Mbit/s, 21 dB for 10 Mbit/s and 23 dB for 5 Mbit/s dB with an PER of 10% at an MPDU length of 1000 bytes.

1.3.8.4. Receiver Alternate Channel Rejection

Alternate channel rejection is defined between any two channels that located alternatively next to each other.

The adjacent channel rejection shall be equal to or better than 50 dB for 30 Mbit/s, 50 dB for 20 Mbit/s, 46 dB for 15 Mbit/s, 49 dB for 10 Mbit/s and 50 dB for 5 Mbit/s dB with an PER of 10% at an MPDU length of 1000 bytes.

1.3.8.5. Reception Level Detection

The OFDM PHY shall provide the capability to detect the reception level. The reception level detection values (RF level predicted values) for RF input level of -89 dBm ~ -30 dBm have monotonically increasing characteristics, and absolute accuracy is ± 6 dB.

1.3.9. PLCP Transmit Procedure

The PLCP transmit procedure is shown in Figure 118. In order to transmit data, PHY-TXSTART.request shall be enabled so that the PHY entity shall be in the transmit state. Further, the PHY shall be set to operate at the appropriate frequency through Station Management via the PLME. Other transmit parameters such as DATARATE and TX power are set via the PHY-SAP with the PHY-TXSTART.request(TXVECTOR) as described in clause 1.2.2.

Based on the status of CCA indicated by PHY-CCA.indicate, the MAC will assess that the channel is clear. A clear channel shall be indicated by PHY-CCA.indicate(IDLE). If the channel is clear, transmission of the PPDU shall be initiated by issuing the PHY-TXSTART.request (TXVECTOR) primitive. The TXVECTOR elements for the PHY-TXSTART.request are the PLCP header parameters SIGNAL (DATARATE), SERVICE and LENGTH and the PMD parameter of TXPWR_LEVEL. The PLCP header parameter LENGTH is indicated by the TXVECTOR.

The PLCP shall issue PMD_TXPWRLVL and PMD_RATE primitives to configure the PHY. The PLCP shall then issue a PMD_TXSTART.request and transmission of the PLCP preamble and PLCP header based on the parameters passed in the PHY-TXSTART.request primitive. Once PLCP preamble transmission is started, the PHY entity shall immediately initiate data scrambling and data encoding. The scrambled and encoded data shall be then exchanged between the MAC and the PHY by a series of PHY-DATA.request(DATA) primitives issued by the MAC and PHY-DATA.confirm primitives issued by the PHY. The modulation rate change, if any, shall be initiated from the SERVICE field data of the PLCP header as described in clause 1.3.2. The PHY proceeds with MPDU transmission through a series of data octet transfers from the MAC. The PLCP header parameters,

SERVICE, LENGTH, CRC and MPDU are encoded by the convolutional encoder with the bit-stealing function described in clause 1.3.3.8. At the PMD layer, the data octets are sent in LSB to MSB order and presented to the PHY layer through PMD_DATA.request primitives. Transmission can be prematurely terminated by the MAC through the primitive PHY-TXEND.request. PHY-TXSTART shall be disabled by the issuance of the PHY-TXEND.request. Normal termination occurs after the transmission of the final bit of the last MPDU octet according to the number supplied in the OFDM PHY preamble LENGTH field. The packet transmission shall be completed and the PHY entity shall enter the receive state (i.e. PHY-TXSTART shall be disabled). Each PHY-TXEND.request is acknowledged with a PHY-TXEND.confirm primitive from the PHY. In case that the coded MPDU (CMPDU) is not multiples of OFDM symbol, bits shall be stuffed to make the CMPDU length multiples of OFDM symbol.

In the PMD, the Guard Interval (GI) shall be inserted in every OFDM symbol as a countermeasure against the severe delay spread.

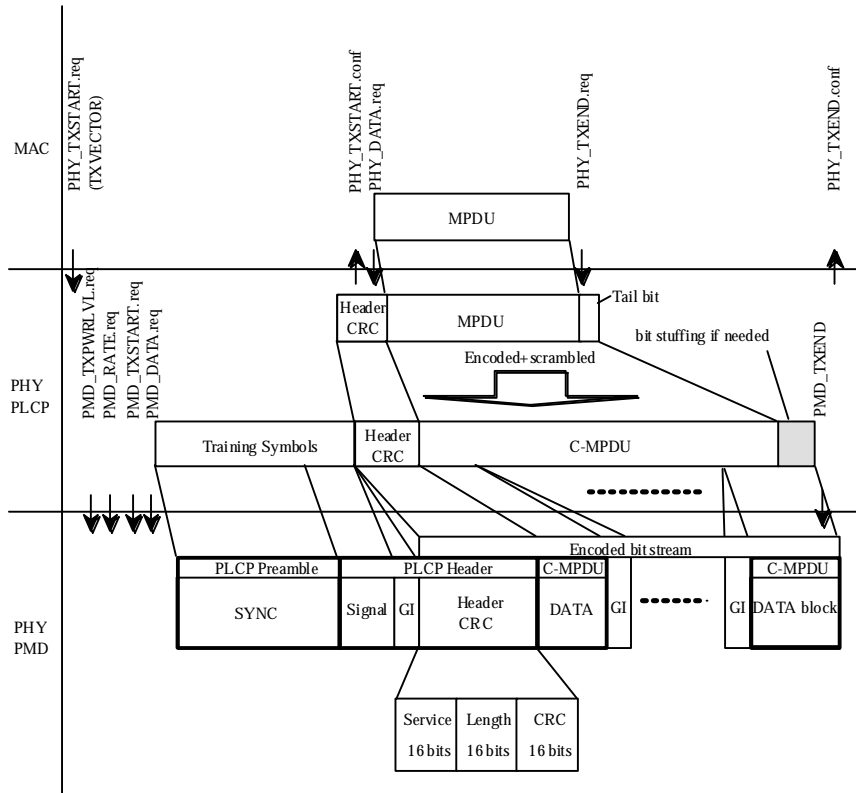

Figure 118, PLCP Transmit Procedure

A typical state machine implementation of the PLCP transmit procedure is provided in Figure 119.

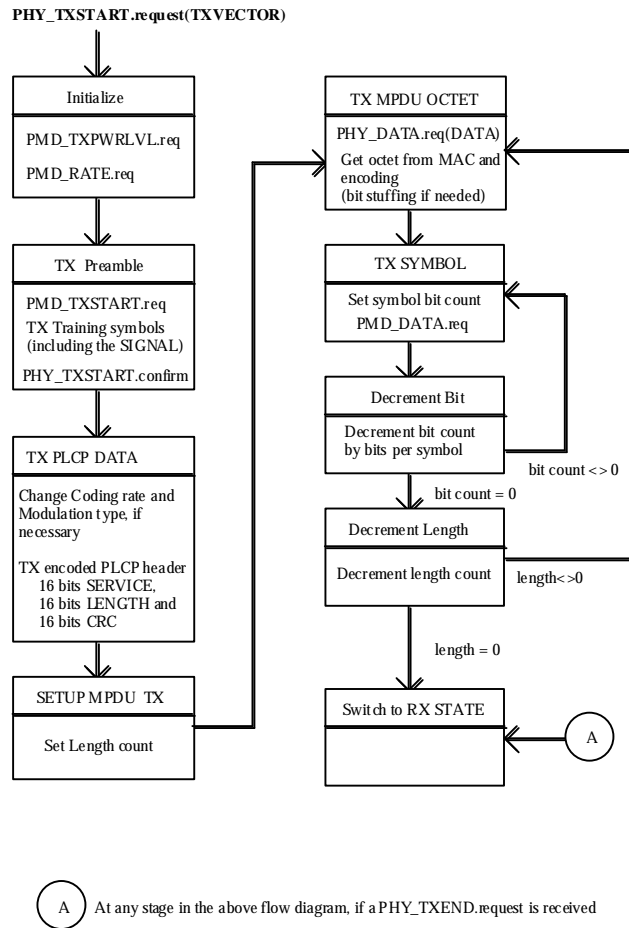

Figure 119, PLCP Transmit State Machine

1.3.10. PLCP Receive Procedure

The PLCP receive procedure is shown in Figure 120. In order to receive data, PHY-TXSTART.request shall be disabled so that the PHY entity is in the receive state. Further, through Station Management via the PLME, the PHY is set to the appropriate frequency. Other receive parameters such as RSSI and indicated DATARATE may be accessed via the PHY-SAP.

Upon receiving the transmitted PLCP preamble, PMD_RSSI.indicate shall report a significant received signal strength level to the PLCP. This indicates activity to the MAC via PHY_CCA.indicate. PHY_CCA.indicate (BUSY) shall be issued for reception of a signal prior to correct reception of the PLCP frame. The PMD primitive PMD_RSSI is issued to update the RSSI and parameter reported to the MAC.

After PHY-CCA.indicate is issued, the PHY entity shall begin receiving the training symbols and searching for the SIGNAL in order to set the demodulation type and decoding rate. Once the SIGNAL is detected, FEC decode and CCITT CRC-16 processing shall be initiated and the PLCP 802.11 SERVICE and LENGTH fields are received, decoded (Viterbi decoder is recommended) and checked by CCITT CRC-16 FCS. If the CCITT CRC-16 FCS check fails, the PHY receiver shall return to the RX Idle state as depicted in Figure 121. Should the status of CCA return to the IDLE state during reception prior to completion of the full PLCP processing, the PHY receiver shall return to the RX Idle state.

If the PLCP header reception is successful (and the SIGNAL field is completely recognizable and supported), a PHY-RXSTART.indicate(RXVECTOR) shall be issued. The RXVECTOR associated with this primitive includes the SIGNAL field, the SERVICE field, the MPDU length in bytes and RSSI.

The received MPDU bits are assembled into octets, decoded and presented to the MAC using a series of PHY-DATA.indicate(DATA) primitive exchanges. The rate change indicated in the 802.11 SIGNAL field shall be initiated from the SERVICE field data of the PLCP header as described in clause 1.3.2. The PHY proceeds with

MPDU reception. After the reception of the final bit of the last MPDU octet indicated by the PLCP preamble LENGTH field, the receiver shall be returned to the RX Idle state as shown in Figure 121. A PHY-RXEND.indicate (NoError) primitive shall be issued.

In the event that a change in RSSI would cause the status of CCA to return to the IDLE state before the complete reception of the MPDU as indicated by the PLCP LENGTH field, the error condition PHY-RXEND.indicate(CarrierLost) shall be reported to the MAC. The OFDM PHY will ensure that the CCA will indicate a busy medium for the intended duration of the transmitted packet.

If the indicated rate in the SIGNAL field is not receivable, a PHY-RXSTART.indicate will not be issued. The PHY shall issue the error condition PHY-RXEND.indicate(UnsupportedRate). If the PLCP header is successful, but the SERVICE field is out of 802.11 OFDM specification, a PHY-RXSTART.indicate will not be issued. The PHY shall issue the error condition PHY-RXEND.indicate(FormatViolation). Also, in this case, the OFDM PHY will ensure that the CCA shall indicate a busy medium for the intended duration of the transmitted frame as indicated by the LENGTH field. The intended duration is indicated by the LENGTH field.

Even if data is received after exceeding the indicated data length, the data should be the stuffed bits for a consistent OFDM symbol.

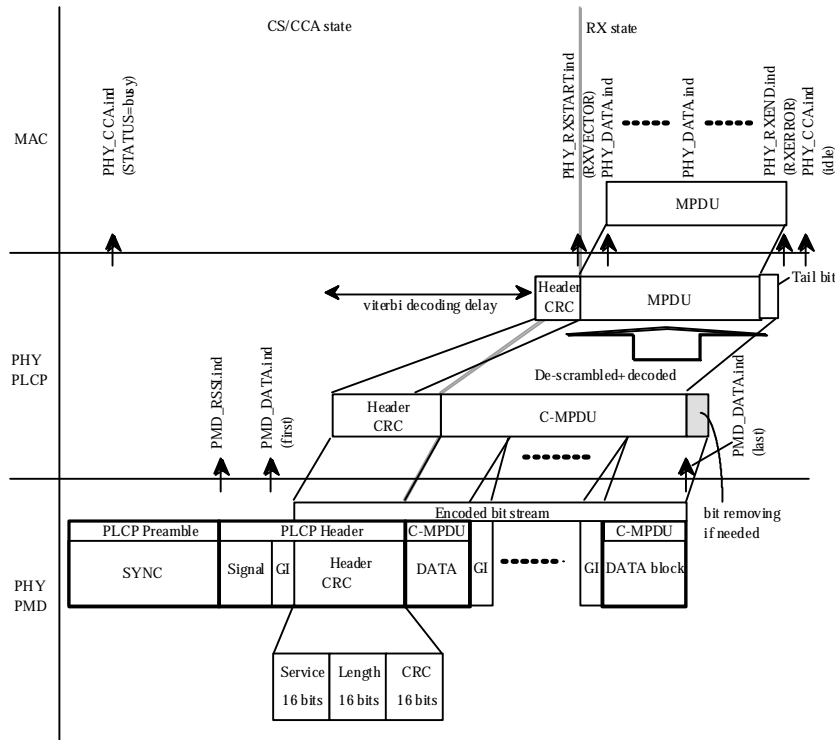

Figure 120, PLCP Receive Procedure

A typical state machine implementation of the PLCP receive procedure is provided in Figure 121.

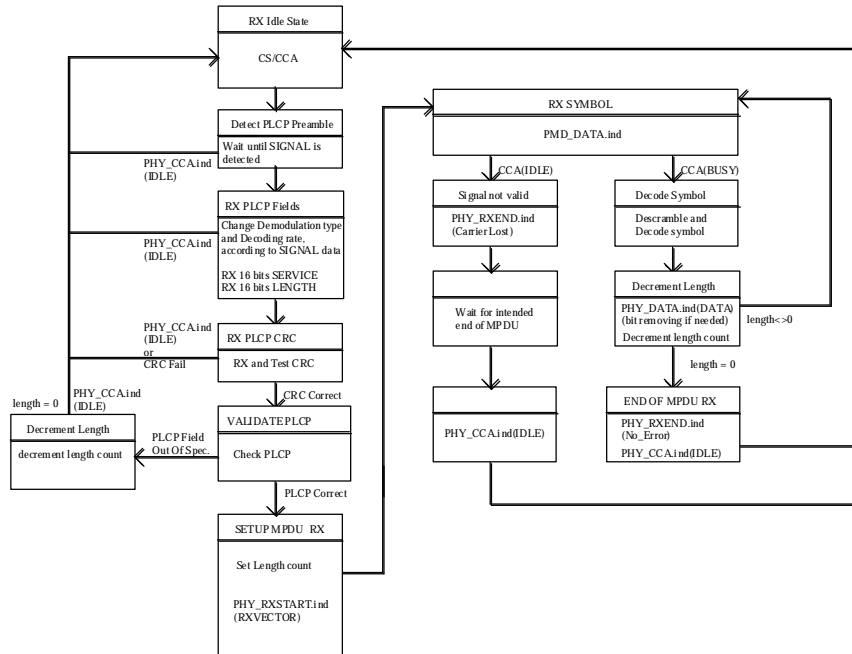

Figure 121, PLCP Receive State Machine

1.4. OFDM Physical Layer Management Entity (PLME)

1.4.1. PLME_SAP Sublayer Management primitives

Table 78 lists the MIB attributes which may be accessed by the PHY sublayer entities and intra layer of higher Layer Management Entities (LME). These attributes are accessed via the PLME-GET, PLME-SET and PLME-RESET primitives defined in clause 10.

1.4.2. OFDM Physical Layer Management Information Base

All OFDM Physical Layer Management Information Base attributes are defined in clause 13 with specific values defined in Table 85.

Managed Object	Default Value / Range	Operational Semantics
AgPhyOperationGroup		
aPHYType	OFDM-5. (04)	Static
ATempType	implementation dependent	Static
ACWmin	15	Static
ACWmax	1023	Static
aRegDomainsSupported	implementation dependent	Static
aCurrentRegDomain	implementation dependent	Static
aSlotTime	6 μs	Static
aCCATime	< 4 μs	Static
aRxTxTurnaroundTime	8.8 μs	Static
aTxPLCPDelay	<< 1 μs	Static
aRxTxSwitchTime	<< 1 μs	Static
aTxRFDelay	< 8.8 μs	Static
aSIFSTime	13 μs	Static
aRxRFDelay	4 μs	Static
aRxPLCPDelay	7 μs	Static

aMACProcessingDelay	< 2 μ s	Static
aPreambleLength	19 μ s	Static
aPLCPHeaderLength	12 μ s (for 5 Mbit/s) 7 μ s (for 10 Mbit/s) 6 μ s (for 15 Mbit/s) 5 μ s (for 20 Mbit/s) 4 μ s (for 30 Mbit/s)	Static
aMPDUDurationFactor	4/3 (for 15, 30 Mbit/s) 2 (for 5, 10, 20 Mbit/s)	Dynamic
agPhyRateGroup		
aSupportedDataRatesTx	5, 10, 15, 20, 30 Mbit/s	Static
aSupportedDataRatesRx	5, 10, 15, 20, 30 Mbit/s	Static
aMPDUMaxLength	65535	Static
agPhyAntennaGroup		
aDiversitySupport	implementation dependent	Static
agPhyTxPowerGroup		
aNumberSupportedPowerLevels	implementation dependent	Static
aTxPowerLevel1	implementation dependent	Static
aTxPowerLevel2	implementation dependent	Static
aTxPowerLevel3	implementation dependent	Static
aTxPowerLevel4	implementation dependent	Static
aTxPowerLevel5	implementation dependent	Static
aTxPowerLevel6	implementation dependent	Static
aTxPowerLevel7	implementation dependent	Static
aTxPowerLevel8	implementation dependent	Static
ACurrentTxPowerLevel	implementation dependent	Dynamic
AgPhyOFDMGroup		
ACurrentFrequency	implementation dependent	Dynamic
ATThreshold	implementation dependent	Dynamic
AgPhyPwrSavingGroup		
ADozeTurnonTime	implementation dependent	Static
ACurrentPowerState	implementation dependent	Dynamic
AgAntennasListGroup		
ADiversitySelectRx	implementation dependent	Dynamic

Table 85, MIB Attribute Default Values / Ranges

Notes: The column titled Operational Semantics contains two types: static and dynamic. Static MIB attributes are fixed and cannot be modified for a given PHY implementation. MIB Attributes defined as dynamic can be modified by some management entity.

1.5. OFDM Physical Medium Dependent Sublayer

1.5.1. Scope and Field of Application

This clause describes the PMD services provided to the PLCP for the OFDM Physical Layer. Also defined in this clause are the functional, electrical and RF characteristics required for interoperability of implementations conforming to this specification. The relationship of this specification to the entire OFDM PHY Layer is shown in

Figure 122.

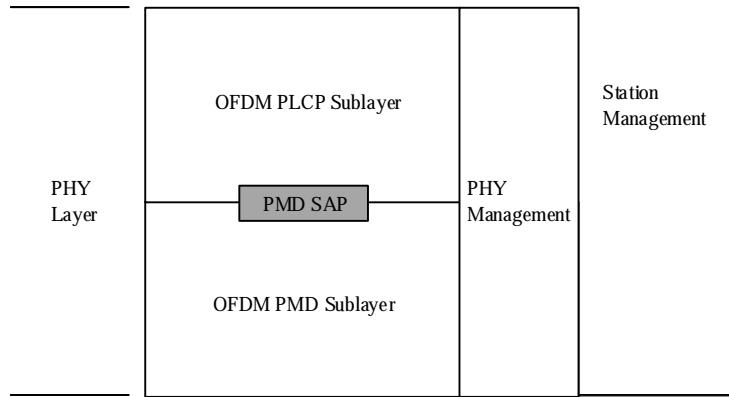

Figure 122, PMD Layer Reference Model

1.5.2. Overview of Service

The OFDM Physical Medium Dependent Sublayer accepts Physical Layer Convergence Procedure sublayer service primitives and provides the actual means by which data shall be transmitted or received from the medium. The combined function of OFDM PMD sublayer primitives and parameters for the receive function results in a data stream, timing information, and associated received signal parameters being delivered to the PLCP sublayer. A similar functionality shall be provided for data transmission.

1.5.3. Overview of Interactions

The primitives associated with the 802.11 PLCP sublayer to the OFDM PMD falls into two basic categories:

- a) Service primitives that support PLCP peer-to-peer interactions.
- b) Service primitives that have local significance and support sublayer-to-sublayer interactions.

1.5.4. Basic Service and Options

All of the service primitives described in this clause are considered mandatory unless otherwise specified.

1.5.4.1. PMD_SAP Peer-to-Peer Service Primitives

The following table indicates the primitives for peer-to-peer interactions.

Primitive	Request	Indicate	Confirm	Response
PMD_DATA	X	X		

Table 86, PMD_SAP Peer-to-Peer Service Primitives

1.5.4.2. PMD_SAP Sublayer-to-Sublayer Service Primitives

The following table indicates the primitives for sublayer-to-sublayer interactions.

Primitive	Request	Indicate	Confirm	Response
PMD_TXSTART	X			
PMD_TXEND	X			
PMD_TXPWRLVL	X			
PMD_RATE	X			
PMD_RSSI		X		

Table 86, PMD_SAP Sublayer-to-Sublayer Service Primitives

1.5.4.3. PMD_SAP Service Primitive Parameters

The following table shows the parameters used by one or more of the PMD_SAP Service Primitives.

Parameter	Associate Primitive	Value
TXD_UNIT	PMD_DATA.request	One(1), Zero(0): one OFDM symbol value
RXD_UNIT	PMD_DATA.indicate	One(1), Zero(0): one OFDM symbol value
TXPWR_LEVEL	PMD_TXPWRLVL.request	1, 2, 3, 4 (max of 4 levels)
RATE	PMD_RATE.request	10 Mbit/s (for DBPSK) 20 Mbit/s (for DQPSK) 40 Mbit/s (for 16QAM)
RSSI	PMD_RSSI.indicate	0-8 bits of RSSI

Table 87, List of Parameters for the PMD Primitives

1.5.5. PMD_SAP Detailed Service Specification

The following clause describes the services provided by each PMD primitive.

1.5.5.1. PMD_DATA.request

Function

This primitive defines the transfer of data from the PLCP sublayer to the PMD entity.

Semantic of the Service Primitive

The primitive shall provide the following parameters:

PMD_DATA.request(TXD_UNIT)

The TXD_UNIT parameter shall be the n-bit combination of “0” and “1” for one symbol of OFDM modulation. If the length of a C-MPDU is shorter than n bits, “0” bits are added to be a OFDM symbol. This parameter represents a single block of data which in turn shall be used by the PHY to be encoded into OFDM transmitted symbol.

When Generated

This primitive shall be generated by the PLCP sublayer to request transmission of one OFDM symbol. The data clock for this primitive shall be supplied by PMD layer based on the OFDM symbol clock.

Effect of Receipt

The PMD performs the differential encoding, interleaving and transmission of the data.

1.5.5.2. PMD_DATA.indicate

Function

This primitive defines the transfer of data from the PMD entity to the PLCP sublayer.

Semantic of the Service Primitive

The primitive shall provide the following parameters:

PMD_DATA.indicate(RXD_UNIT)

The RXD_UNIT parameter shall be the n-bit combination of “0” and “1” for one symbol of OFDM modulation.

This parameter represents a single symbol which has been demodulated by the PMD entity.

When Generated

This primitive generated by the PMD entity, forwards received data to the PLCP sublayer. The data clock for this primitive shall be supplied by PMD layer based on the OFDM symbol clock.

Effect of Receipt

The PLCP sublayer interprets the bits which are recovered as part of the PLCP convergence procedure or passes the data to the MAC sublayer as part of the MPDU.

1.5.5.3. PMD_TXSTART.request

Function

This primitive, generated by the PHY PLCP sublayer, initiates PPDU transmission by the PMD layer.

Semantic of the Service Primitive

The primitive shall provide the following parameters:

PMD_TXSTART.request

When Generated

This primitive shall be generated by the PLCP sublayer to initiate the PMD layer transmission of the PPDU. The PHY-TXSTART.request primitive shall be provided to the PLCP sublayer prior to issuing the PMD_TXSTART command.

Effect of Receipt

PMD_TXSTART initiates transmission of a PPDU by the PMD sublayer.

1.5.5.4. PMD_TXEND.request

Function

This primitive, generated by the PHY PLCP sublayer, ends PPDU transmission by the PMD layer.

Semantic of the Service Primitive

The primitive shall provide the following parameters:

PMD_TXEND.request

When Generated

This primitive shall be generated by the PLCP sublayer to terminate the PMD layer transmission of the PPDU.

Effect of Receipt

PMD_TXEND terminates transmission of a PPDU by the PMD sublayer.

1.5.5.5. PMD_TXPWRLVL.request

Function

This primitive, generated by the PHY PLCP sublayer, selects the power level used by the PHY for transmission.

Semantic of the Service Primitive

The primitive shall provide the following parameters:

PMD_TXPWRLVL.request(TXPWR_LEVEL)

TXPWR_LEVEL selects which of the transmit power levels should be used for the current packet transmission. The number of available power levels shall be determined by the MIB parameter aNumberSupportedPowerLevels. Clause 1.3.7.1 provides further information on the OFDM PHY power level control capabilities.

When Generated

This primitive shall be generated by the PLCP sublayer to select a specific transmit power. This primitive shall be applied prior to setting PMD_TXSTART into the transmit state.

Effect of Receipt

PMD_TXPWRLVL immediately sets the transmit power level to that given by TXPWR_LEVEL.

1.5.5.6. PMD_RATE.request**Function**

This primitive, generated by the PHY PLCP sublayer, selects the modulation rate which shall be used by the OFDM PHY for transmission.

Semantic of the Service Primitive

The primitive shall provide the following parameters:

PMD_RATE.request(RATE)

RATE selects which of the OFDM PHY data rates shall be used for MPDU transmission. Clause 1.3.6.6 provides further information on the OFDM PHY modulation rates. The OFDM PHY rate change capability is fully described in clause 1.3.

When Generated

This primitive shall be generated by the PLCP sublayer to change or set the current OFDM PHY modulation rate used for the MPDU portion of a PPDU.

Effect of Receipt

The receipt of PMD_RATE selects the rate which shall be used for all subsequent MPDU transmissions. This rate shall be used for transmission only. The OFDM PHY shall still be capable of receiving all the required OFDM PHY modulation rates.

1.5.5.7. PMD_RSSI.indicate**Function**

This primitive, generated by the PMD sublayer, provides to the PLCP and MAC entity the Received Signal Strength.

Semantic of the Service Primitive

The primitive shall provide the following parameters:

PMD_RSSI.indicate(RSSI)

The RSSI shall be a measure of the RF energy received by the OFDM PHY. RSSI indications of up to 8 bits (256 levels) are supported.

When Generated

This primitive shall be generated by the PMD when the OFDM PHY is in the receive state. It shall be continuously available to the PLCP which in turn provides the parameter to the MAC entity.

Effect of Receipt

This parameter shall be provided to the PLCP layer for information only. The RSSI may be used as part of a Clear Channel Assessment scheme.

