

Project	IEEE 802.16 Broadband Wireless Access Working Group < http://ieee802.org/16 >	
Title	H-ARQ support corrections, for OFDMA PHY mode	
Date Submitted	2004-04-22	
Source(s)	<p>Panyuh Joo, Seungjoo Maeng, Jaeho Jeon, panyuh@samsung.com Soonyoung Yoon, Jeong-Heon Kim, Jaehyok Lee, Myungkwang Byun, Inseok Hwang, yigall@runcom.co.il Jaehee Cho, Jiho Jang, Sanghoon Sung, Samsung Electronics Co. Ltd. lim@etri.re.kr</p> <p>Yigal Leiba, Zion Hadad, Yossi Segal, Itzik Kitroser Runcom Technologies</p> <p>Choongil Yeh, Hyuongsso Lim, Yuro Lee, Jongee Oh, DongSeung Kwon, ETRI</p>	
Re:	Sponsor re-circulation Ballot	
Abstract	H-ARQ support corrections, for OFDMA PHY mode	
Purpose	Adoption of proposed changes into P802.16-REVd/D4-2004	
Notice	This document has been prepared to assist IEEE 802.16. It is offered as a basis for discussion and is not binding on the contributing individual(s) or organization(s). The material in this document is subject to change in form and content after further study. The contributor(s) reserve(s) the right to add, amend or withdraw material contained herein.	
Release	The contributor grants a free, irrevocable license to the IEEE to incorporate material contained in this contribution, and any modifications thereof, in the creation of an IEEE Standards publication; to copyright in the IEEE's name any IEEE Standards publication even though it may include portions of this contribution; and at the IEEE's sole discretion to permit others to reproduce in whole or in part the resulting IEEE Standards publication. The contributor also acknowledges and accepts that this contribution may be made public by IEEE 802.16.	
Patent Policy and Procedures	<p>The contributor is familiar with the IEEE 802.16 Patent Policy and Procedures (Version 1.0) <http://ieee802.org/16/ipr/patents/policy.html>, including the statement "IEEE standards may include the known use of patent(s), including patent applications, if there is technical justification in the opinion of the standards-developing committee and provided the IEEE receives assurance from the patent holder that it will license applicants under reasonable terms and conditions for the purpose of implementing the standard."</p> <p>Early disclosure to the Working Group of patent information that might be relevant to the standard is essential to reduce the possibility for delays in the development process and increase the likelihood that the draft publication will be approved for publication. Please notify the Chair <mailto:r.b.marks@ieee.org> as early as possible, in written or electronic form, of any patents (granted or under application) that may cover technology that is under consideration by or has been approved by IEEE 802.16. The Chair will disclose this notification via the IEEE 802.16 web site <http://ieee802.org/16/ipr/patents/notices>.</p>	

In page 529, line 47, correct section 8.4.9.2.3.1 as shown below:

8.4.9.2.3.1 CTC encoder

The Convolutional Turbo Code defined in this section is designed to enable support of hybrid ARQ (H-ARQ). H-ARQ implementation is optional. The Convolutional Turbo Code encoder, including its constituent encoder, is depicted in Figure 240. It uses a double binary Circular Recursive Systematic Convolutional code. The bits of the data to be encoded are alternately fed to A and B, starting with the MSB of the first byte being fed to A. The encoder is fed by blocks of k bits or N couples ($k = 2 * N$ bits). For all the frame sizes k is a multiple of 8 and N is a multiple of 4. Further N shall be limited to: $8 \leq N/4 \leq 1024$.

The polynomials defining the connections are described in octal and symbol notations as follows:

- For the feedback branch: 0xB, equivalently $1 + D + D^3$ (in symbolic notation)
- For the Y parity bit: 0xD, equivalently $1 + D^2 + D^3$
- For the W parity bit: 0x9, equivalently $1 + D^3$

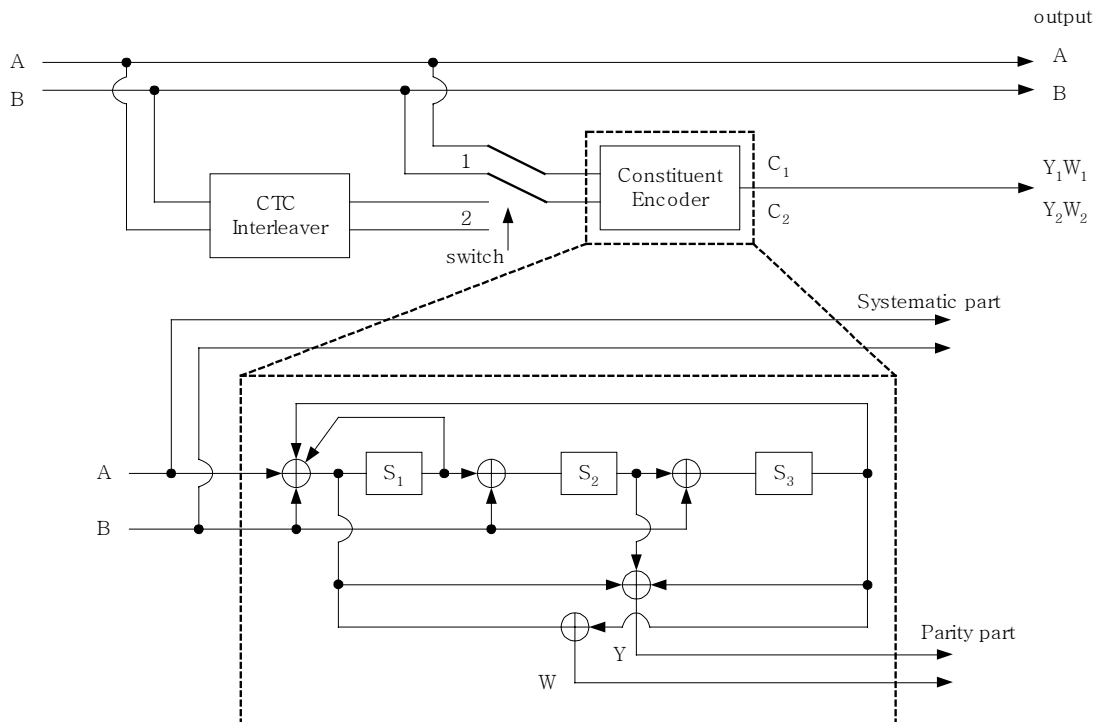

Figure 240—CTC encoder

First, the encoder (after initialization by the circulation state Sc_1 , see 8.4.9.2.3.3) is fed the sequence in the natural order (position 1) with the incremental address $i = 0 .. N-1$. This first encoding is called Sc_1 encoding. Then the encoder (after initialization by the circulation state Sc_2 , see 8.4.9.2.3.3) is fed by the interleaved sequence (switch in position 2) with incremental address $j = 0, \dots, N-1$. This second encoding is called C_2 encoding.

The order in which the encoded bit shall be fed into the [interleaver \(8.4.9.3\)](#) [data modulation block \(8.4.9.4.2\)](#) is:

$$\underline{A, B, Y_1, W_1, Y_2, W_2 = A_1, A_2, \dots, A_N, B_1, B_2, \dots, B_N, Y_{11}, Y_{12}, \dots, Y_{1N}, W_{11}, W_{12}, \dots, W_{1N}, Y_{21}, Y_{22}, \dots, Y_{2N}, W_{21}, W_{22}, \dots, W_{2N}}$$

$$\underline{A, B, Y_1, Y_2, W_1, W_2 = A_1, B_1, \dots, A_N, B_N, Y_{11}, Y_{12}, \dots, Y_{1N}, Y_{21}, Y_{22}, \dots, Y_{2N}, W_{11}, W_{12}, \dots, W_{1N}, W_{21}, W_{22}, \dots, W_{2N}}$$

where M is the number of parity bits.

[Note that this interleaver \(8.4.9.3\) shall not be used when using CTC](#)

Table 284 gives the block sizes, code rates, channel efficiency, and code parameters for the different modulation and coding schemes. As 64-QAM is optional, the codes for this modulation shall only be implemented if the modulation is implemented.

The encoding block size shall depend on the number of subchannels allocated and the modulation specified for the current transmission. Concatenation of a number of subchannels shall be performed in order to make larger blocks of coding where it is possible, with the limitation of not passing the largest block under the same coding rate (the block defined by 64-QAM modulation). Table ccc specifies the concatenation of subchannels for different allocations and modulations. The concatenation rule shall not be used when using H-ARQ.

For any modulation and FEC rate, given an allocation of n subchannels, we define the following parameters:

- j = parameter dependent on the modulation and FEC rate
- n = number of allocated subchannels
- k = floor(n / j) _____ (aaa)
- m = n modulo j

Table bbb shows the rules used for subchannel concatenation.

Table bbb—Subchannel concatenation rule for CTC

<u>Number of subchannels</u>	<u>Subchannels concatenated</u>
<u>n <= j</u> <u>n ≠ 7</u>	<u>1 block of n subchannels</u>
<u>n = 7</u>	<u>1 block of 4 subchannels</u> <u>1 block of 3 subchannels</u>
<u>n > j</u>	<u>(k-1) blocks of j subcahnnels</u> <u>1 block of L_{b1} subchannels</u> <u>1 block of L_{b2} subchannels</u> <u>Where:</u> <u>L_{b1} = ceil((m+j)/2)</u> <u>L_{b2} = floor((m+j)/2)</u> <u>If (L_{b1} == 7) or (L_{b2} == 7)</u> <u>L_{b1} = L_{b1} + 1; L_{b2} = L_{b2} - 1;</u>

Table ccc—Encoding Subchannel concatenation for different allocations and modulations in CTC

<u>Modulation and rate</u>	<u>i</u>
<u>QPSK 1/2</u>	<u>j = 10</u>
<u>QPSK 3/4</u>	<u>j = 6</u>
<u>QAM16 1/2</u>	<u>j = 5</u>
<u>QAM16 3/4</u>	<u>j = 3</u>
<u>QAM64 1/2</u>	<u>j = 3</u>
<u>QAM64 2/3</u>	<u>j = 2</u>
<u>QAM64 3/4</u>	<u>j = 2</u>
<u>QAM64 5/6</u>	<u>j = 2</u>

Table 284 gives the block sizes, code rates, channel efficiency, and code parameters for the different modulation and coding schemes. As 64-QAM is optional, the codes for this modulation shall only be implemented if the modulation is implemented.

Table 256—Optimal CTC channel coding per modulation

Modulation	Data block size (bytes)	Encoded data block size (bytes)	Code rate	N	P0	P1	P2	P3
QPSK	6	12	1/2	24	5	0	0	0
QPSK	12	24	1/2	48	13	24	0	24
QPSK	18	36	1/2	72	11	6	0	6
QPSK	24	48	1/2	96	7	48	24	72
QPSK	30	60	1/2	120	13	60	0	60
QPSK	36	72	1/2	144	17	74	72	2
<u>QPSK</u>	<u>48</u>	<u>96</u>	<u>1/2</u>	<u>192</u>	<u>11</u>	<u>96</u>	<u>48</u>	<u>144</u>
<u>QPSK</u>	<u>54</u>	<u>108</u>	<u>1/2</u>	<u>216</u>	<u>13</u>	<u>108</u>	<u>0</u>	<u>108</u>
<u>QPSK</u>	<u>60</u>	<u>120</u>	<u>1/2</u>	<u>240</u>	<u>13</u>	<u>120</u>	<u>60</u>	<u>180</u>
QPSK	9	12	3/4	36	11	18	0	18
QPSK	18	24	3/4	72	11	6	0	6
QPSK	27	36	3/4	108	11	54	56	2
QPSK	36	48	3/4	144	17	74	72	2
<u>QPSK</u>	<u>45</u>	<u>60</u>	<u>3/4</u>	<u>180</u>	<u>11</u>	<u>90</u>	<u>0</u>	<u>90</u>
<u>QPSK</u>	<u>54</u>	<u>72</u>	<u>3/4</u>	<u>216</u>	<u>13</u>	<u>108</u>	<u>0</u>	<u>108</u>
QAM16	12	24	1/2	48	13	24	0	24
QAM16	24	48	1/2	96	7	48	24	72
QAM16	36	72	1/2	144	17	74	72	2
<u>QAM16</u>	<u>48</u>	<u>96</u>	<u>1/2</u>	<u>192</u>	<u>11</u>	<u>96</u>	<u>48</u>	<u>144</u>
<u>QAM16</u>	<u>60</u>	<u>120</u>	<u>1/2</u>	<u>240</u>	<u>13</u>	<u>120</u>	<u>60</u>	<u>180</u>
QAM16	18	24	3/4	72	11	6	0	6
QAM16	36	48	3/4	144	17	74	72	2
<u>QAM16</u>	<u>54</u>	<u>108</u>	<u>3/4</u>	<u>216</u>	<u>13</u>	<u>108</u>	<u>0</u>	<u>108</u>
QAM64	18	36	1/2	72	11	6	0	6
QAM64	36	72	1/2	144	17	74	72	2
<u>QAM64</u>	<u>54</u>	<u>108</u>	<u>1/2</u>	<u>216</u>	<u>13</u>	<u>108</u>	<u>0</u>	<u>108</u>
QAM64	24	36	2/3	96	7	48	24	72
<u>QAM64</u>	<u>48</u>	<u>72</u>	<u>2/3</u>	<u>192</u>	<u>11</u>	<u>96</u>	<u>48</u>	<u>144</u>
QAM64	27	36	3/4	108	11	54	56	2
<u>QAM64</u>	<u>54</u>	<u>72</u>	<u>3/4</u>	<u>216</u>	<u>13</u>	<u>108</u>	<u>0</u>	<u>108</u>
<u>QAM64</u>	<u>30</u>	<u>36</u>	<u>5/6</u>	<u>120</u>	<u>13</u>	<u>60</u>	<u>0</u>	<u>60</u>
<u>QAM64</u>	<u>60</u>	<u>72</u>	<u>5/6</u>	<u>240</u>	<u>13</u>	<u>120</u>	<u>60</u>	<u>180</u>

Table hhh—Optimal CTC channel coding per modulation when supporting H-ARQ

<u>Data block size (bytes)</u>	<u>N</u>	<u>P0</u>	<u>P1</u>	<u>P2</u>	<u>P3</u>
6	24	5	0	0	0
12	48	13	24	0	24
18	72	11	6	0	6
24	96	7	48	24	72
36	144	17	74	72	2
48	192	11	96	48	144
60	240	13	120	60	180
120	480	13	240	120	360
240	960	13	480	240	720
360	1440	17	720	360	540
480	1920	17	960	480	1440
600	2400	17	1200	600	1800

In page 532, line 40, correct the text as shown below:

8.4.9.2.3.4 Subpacket generation

Proposed FEC structure punctures the mother codeword to generate subpacket with various coding rates. The subpacket is also used as H-ARQ packet transmission. Figure ~~bbb~~244 shows block diagram of subpacket generation. 1/3 CTC encoded codeword goes through interleaving block and the puncturing is performed. Figure 245 shows block diagram of the interleaving block. The puncturing is performed to select the consecutive interleaved bit sequence that starts at any point of whole codeword. For the first transmission, the subpacket is generated to select the consecutive interleaved bit sequence that starts from the first bit of the systematic part of the mother codeword. The length of the subpacket is chosen according to the needed coding rate reflecting the channel condition. The first subpacket can also be used as a codeword with the needed coding rate for a burst where H-ARQ is not applied.

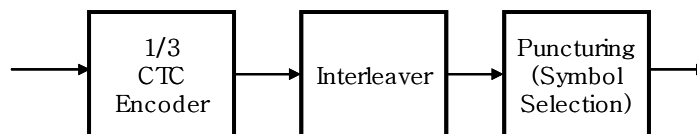

Figure 244— Block diagram of subpacket generation

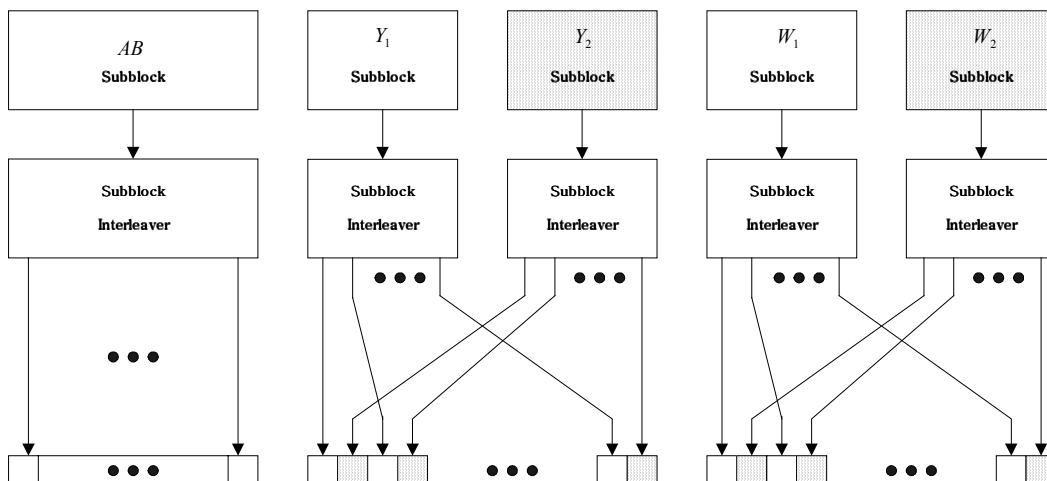

Figure 245— Block diagram of the interleaving scheme

8.4.9.2.3.4.1 Symbol Separation

All of the encoded symbols shall be demultiplexed into 5 subblocks denoted AB , Y_1 , Y_2 , W_1 and W_2 . The encoder output symbols shall be sequentially distributed into 5 subblocks with the first and second encoder output symbols going to the AB subblock, the third to the Y_1 subblock, the fourth to the Y_2 subblock, the fifth to the W_1 subblock, the sixth to the W_2 subblock, etc. The AB subblock is the symbol-by-symbol multiplexed sequence of the input sequence A and B .

$$AB = A_1, B_1, A_2, B_2, \dots, A_N, B_N$$

8.4.9.2.3.4.2 Subblock Interleaving

The five subblocks shall be interleaved separately. For the AB subblock, the interleaving is performed by the unit of pair of two symbols (A_n, B_n). For other subblocks, the interleaving is performed by the unit of symbol. The sequence of interleaver output symbols for each subblock shall be generated by the procedure described below. The entire subblock of symbols (pairs for AB subblock) to be interleaved is written into an array at addresses from 0 to the number of the symbols (pairs for AB subblock) minus one ($N-1$), and the interleaved symbols (pairs for AB subblock) are read out in a permuted order with the i -th symbol (pair for AB subblock) being read from an address A_i ($i = 0$ to $N-1$), as follows:

1. Determine the subblock interleaver parameters, m and J . Table ddd gives these parameters.

2. Initialize i and k to 0.

3. Form a tentative output address T_k according to the formula

$$T_k = 2^m (k \bmod J) + BRO_m(\lfloor k/J \rfloor)$$

where $BRO_m(y)$ indicates the bit-reversed m -bit value of y (i.e., $BRO_3(6) = 3$).

4. If T_k is less than N , $A_i = T_k$ and increment i and k by 1. Otherwise, discard T_k and increment k only.

5. Repeat steps 3 and 4 until all N interleaver output addresses are obtained.

The parameters for the subblock interleavers are specified in Table ddd.

Table ddd – The parameters for the subblock interleavers

Data block size (bits) N_{EP}	N	Subblock Interleaver Parameters	
		m	J
48	24	3	3
72	36	4	3
96	48	4	3
144	72	5	3
192	96	5	3
216	108	6	3
240	120	6	2
288	144	6	3
384	192	6	3
432	216	7	2
480	240	7	2

Table eee – The parameters for the subblock interleavers when supporting H-ARQ

<u>Data block size (bits)</u> N_{EP}	<u>N</u>	<u>Subblock Interleaver Parameters</u>	
		<u>m</u>	<u>J</u>
48	24	3	3
96	48	4	3
144	72	5	3
192	96	5	3
288	144	6	3
384	192	6	3
480	240	7	2
960	480	8	2
1920	960	9	2
2880	1440	9	3
3840	1920	10	2
4800	2400	10	3

8.4.9.2.3.54.3 Interleaving block

The puncturing process is very common to generate various coding rates with Turbo code families. However, the puncturing should guarantee the complementary characteristics of the punctured codeword. In other words, the parity bits of the punctured codeword should be chosen uniformly from the parity bits of a constituent encoder. The parity bits of the punctured codeword should have even number of parities from the two constituent encoders. Because the puncturing is just a simple process to select the subpacket, the proposed FEC structure rely such complementary property on the interleaving block.

Figure eee245 shows block diagram of the interleaving scheme of the proposed FEC structure. At first, the CTC encoder output is separated into a subblock. Then the interleaving is applied for the bit sequence within the subblock. It guarantees the uniformity of the interleaved codeword. Next, Symbol grouping is performed such that the parity bits from the two constituent encoders are interleaved bit by bit. The systematic part of the 1/2 CTC encoder is located at the head of the interleaved codeword. In this way, the proposed FEC structure ensures the quasi-complementary characteristics of the interleaved codeword and thus, complementary characteristics of the subpacket. We just say “quasi-complementary” for the case of breaking the complementariness of few bits after puncturing.

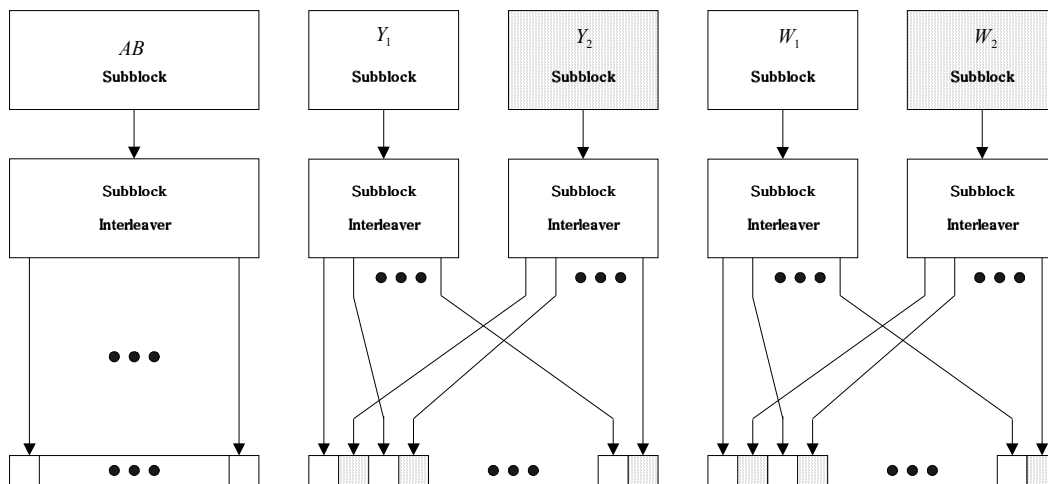

Figure 245—Block diagram of the interleaving scheme

8.4.9.2.3.6.4.3 Symbol selection

Lastly, symbol selection is performed to generate the subpacket. We call the puncturing block as the symbol selection in the viewpoint of subpacket generation.

Mother code is transmitted with one of subpackets. The symbols in a subpacket are formed by selecting specific sequences of symbols from the interleaved CTC encoder output sequence. The resulting subpacket sequence is a binary sequence of symbols for the modulator.

Let

- k be the subpacket index when H-ARQ is enabled. $k=0$ for the first transmission and increases by one for the next subpacket. [k = 0 when H-ARQ is not used.](#)
- N_{EP} be the number of bits in the encoder packet [\(before encoding\)](#)
- N_{SCHk} be the number of subchannel(s) allocated for the k -th subpacket
- m_k be the modulation order for the k th subpacket ($m_k = 2$ for QPSK, 4 for 16QAM, and 6 for 64-QAM); and

$SPID_k$ be the subpacket ID for the k -th subpacket, (for the first subpacket, $SPID_{k=0} = 0$).

Also, let the scrambled and selected symbols be numbered from zero with the 0-th symbol being the first symbol in the sequence. Then, the index of the i -th symbol for the k -th subpacket shall be

$$S_{k,i} = (F_k + i) \bmod(3 * N_{EP})$$

where $i = 0$ to $L_k - 1$,

$$L_k = 48 * N_{SCHk} * m_k, \text{ and}$$

$$F_k = (SPID_k * L_k) \bmod(3 * N_{EP}).$$

The N_{EP} , N_{SCHk} , [m_k](#) and SPID values are determined by the BS and can be inferred by the SS through the allocation size in the DL-MAP and UL-MAP. ~~The m_k parameter is determined in the next subsection.~~ The above symbol selection makes the followings possible.

1. The first transmission includes the systematic part of the mother code. Thus, it can be used as the codeword for a burst where the H-ARQ is not applied.
2. The location of the subpacket can be determined by the SPID itself without the knowledge of previous subpacket. It is very important property for H-ARQ retransmission.

In page 535, line 17, Add a new section as shown below:

8.4.9.2.3.6-5 Optional H-ARQ Support

H-ARQ implementation is optional. The randomization block in 8.4.9.1, the concatenation scheme in 8.4.9.2.3.1 and the interleaving in 8.4.9.3 shall not be applied for the encoding described in this section.

8.4.9.2.3.6-5.1 Padding

MAC PDU (or concatenated MAC PDUs) is a basic unit processed in this channel coding and modulation blocks. When the size of MAC PDU (or concatenated MAC PDUs) is not the element in the allowed set for H-ARQ, '1's are padded at the end of MAC PDU (or concatenated MAC PDUs). The amount of the padding is the same as the difference between the size of the PDU (or concatenated MAC PDUs) and the smallest element in the allowed set that is not less than the size of the PDU (or concatenated MAC PDUs). The padded packet is input into the Randomization block.

The allowed set is {32, 80, 128, 176, 272, 368, 464, 944, 1904, 2784, 3824, 4784, 9584, 14384, 19184, 23984} bits.

8.4.9.2.3.6-5.2 Randomization

The randomization is performed on each allocation (burst), which means that for each allocation of a data block the randomizer shall be used independently.

The Pseudo Random Binary Sequence (PRBS) generator shall be $1 + X^{14} + X^{15}$ as shown in Figure eee. Each data byte to be transmitted shall enter sequentially into the randomizer, MSB first. The seed value shall be used to calculate the randomization bits, which are combined in an XOR operation with the serialized bit stream of each burst. The randomizer sequence is applied to the output from the padding block. The bit issued from the randomizer shall be applied to the CRC encoder.

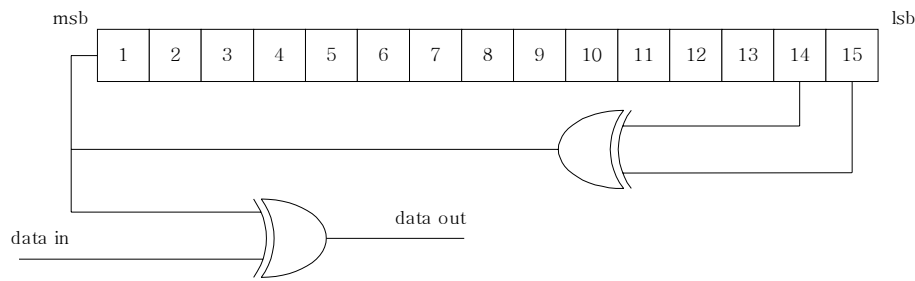

Figure eee – PRBS of the randomizer

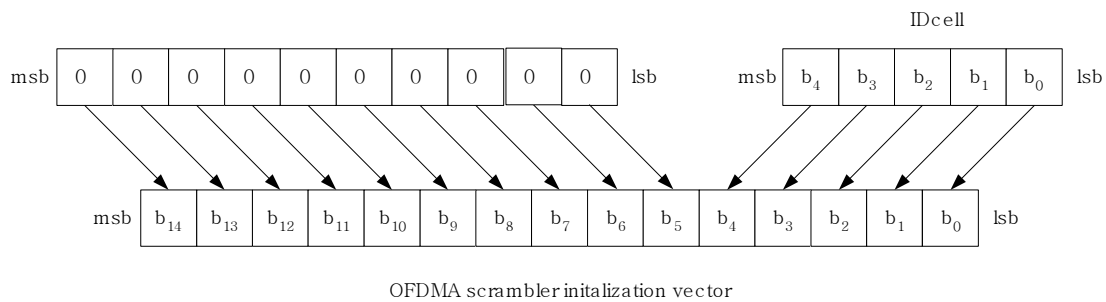

Figure fff – Initialization construction for the PRBS of the randomizer

The scrambler is initialized with the vector created as shown in Figure fff. The lowest 5 bits are ID_{cell} or UL_ID_{cell} and the other bits are set '0'.

8.4.9.2.3.-6-5.3 CRC encoding

When H-ARQ is applied to a packet, error detection is provided on the padded packet through a Cyclic Redundancy Check (CRC). The size of the CRC is 16 bits. CRC16-CCITT, as defined in ITU-T Recommendation X.25, shall be included at the end of the padded and randomized packet. The CRC covers both the padded bits and the information part of the padded and randomized packet. After the CRC operation, The packet size shall belong to set {48, 96, 144, 192, 288, 384, 480, 960, 1920, 2880, 3840, 4800, 9600, 14400, 19200, 24000}.

8.4.9.2.3.-6-5.4 Fragmentation

When the size after the padding and CRC encoding is $n \cdot 4800$ bits they are separately encoded by the block of 4800 bits and concatenated as the same order of the separation before modulation. No operation is performed for the packet whose size after the padding and CRC encoding is not more than 4800 bits.

The bits output from the fragmentation block are denoted by $r_1, r_2, r_3, \dots, r_{N_{EP}}$, and this sequence is defined as encoder packet. N_{EP} is the number of the bits in an encoder packet and defined as encoder packet size. The values of N_{EP} are 48, 96, 144, 192, 288, 384, 480, 960, 1920, 2880, 3840, 4800.

8.4.9.2.3.-6-5.5 CTC encoding and subpacket generation

The CTC encoding and subpacket generation is same as the operation described in 8.4.9.2.3.1~8.4.9.2.3.4.

8.4.9.2.3.-6-4.6-5.6 Modulation order of DL traffic burst

For DL, the modulation order (2 for QPSK, 4 for 16-QAM, and 6 for 64-QAM) shall be set for all the allowed transmission formats as shown in table kkk. The transmission format is given by the N_{EP} (Encoding Packet Size) and the N_{SCH} (number of allotted subchannels). N_{EP} per an encoding packet is {144, 192, 288, 384, 480, 960, 1920, 2880, 3840, 4800}. The N_{SCH} per an encoding packet is {1~480}. In the table, the numbers in the first row are N_{EP} 's and the numbers in the remaining rows are N_{SCH} 's and related parameters.

The supportable modulation schemes are QPSK, 16QAM, and 64QAM. When the N_{EP} and the N_{SCH} are given, the modulation order is determined by the value of MPR (Modulation order Product code Rate). The MPR means the effective number of the information bit transmitted per a subcarrier and is defined as follows.

$$MPR = \frac{N_{EP}}{48 \cdot N_{SCH}}$$

Then, the modulation order is specified by the following rule:

- i) If $0 < MPR < 1.5$, then a QPSK (modulation order 2) is used
- ii) If $1.5 \leq MPR < 3.0$, then a 16QAM (modulation order 4) is used
- iii) If $3.0 \leq MPR < 5.4$, then a 64QAM (modulation order 6) is used

The effective code rate is equal to MPR divided by the modulation order (i.e. 2 for QPSK).

In H-ARQ DL allocation $IE\{\}$ for DL of DL-UL MAP, N_{EP} is encoded by 4 bit field as shown in Table III where encoding is presented with decimal value. N_{SCH} can be derived from H-ARQ DL allocation $IE\{\}$.

When the values of N_{EP} are $n \cdot 4800$, the actual encoding packet size (NEP) is 4800 and this value is applied for the calculation of subpacket length in 8.4.9.2.3.4.3 Symbol selection subclause and MPR in this subclause. Let N_{sch_total} be the number of subchannels allocated to the burst divided by n . When the divided number is not the integer, N_{sch_total} is the largest integer smaller than the divided.

N_{SCH} is same as the largest number that is smaller than N_{sch_total} in the column of the actual encoding packet size (NEP) in table kkk.

Table kkk – Transmission format and modulation level for DL

<u>Nep</u>	<u>144</u>	<u>192</u>	<u>288</u>	<u>384</u>	<u>480</u>	<u>960</u>	<u>1920</u>	<u>2880</u>	<u>3840</u>	<u>4800</u>
<u>Sch</u>	<u>1.00</u>	<u>1.00</u>								
<u>MPR</u>	<u>3.00</u>	<u>4.00</u>								
<u>MOD</u>	<u>6.00</u>	<u>6.00</u>								
<u>Rate</u>	<u>1/2</u>	<u>2/3</u>								
<u>Rate</u>	<u>0.50</u>	<u>0.67</u>								
<u>Sch</u>	<u>2.00</u>	<u>2.00</u>	<u>2.00</u>	<u>2.00</u>	<u>2.00</u>					
<u>MPR</u>	<u>1.50</u>	<u>2.00</u>	<u>3.00</u>	<u>4.00</u>	<u>5.00</u>					
<u>MOD</u>	<u>4.00</u>	<u>4.00</u>	<u>6.00</u>	<u>6.00</u>	<u>6.00</u>					
<u>Rate</u>	<u>3/8</u>	<u>1/2</u>	<u>1/2</u>	<u>2/3</u>	<u>5/6</u>					
<u>Rate</u>	<u>0.38</u>	<u>0.50</u>	<u>0.50</u>	<u>0.67</u>	<u>0.83</u>					
<u>Sch</u>	<u>3.00</u>	<u>3.00</u>	<u>3.00</u>	<u>3.00</u>	<u>3.00</u>					
<u>MPR</u>	<u>1.00</u>	<u>1.33</u>	<u>2.00</u>	<u>2.67</u>	<u>3.33</u>					
<u>MOD</u>	<u>2.00</u>	<u>2.00</u>	<u>4.00</u>	<u>4.00</u>	<u>6.00</u>					
<u>Rate</u>	<u>1/2</u>	<u>2/3</u>	<u>1/2</u>	<u>2/3</u>	<u>5/9</u>					
<u>Rate</u>	<u>0.50</u>	<u>0.67</u>	<u>0.50</u>	<u>0.67</u>	<u>0.56</u>					
<u>Sch</u>		<u>4.00</u>	<u>4.00</u>	<u>4.00</u>	<u>4.00</u>	<u>4.00</u>				
<u>MPR</u>		<u>1.00</u>	<u>1.50</u>	<u>2.00</u>	<u>2.50</u>	<u>5.00</u>				
<u>MOD</u>		<u>2.00</u>	<u>4.00</u>	<u>4.00</u>	<u>4.00</u>	<u>6.00</u>				
<u>Rate</u>		<u>1/2</u>	<u>3/8</u>	<u>1/2</u>	<u>5/8</u>	<u>5/6</u>				
<u>Rate</u>		<u>0.50</u>	<u>0.38</u>	<u>0.50</u>	<u>0.63</u>	<u>0.83</u>				
<u>Sch</u>	<u>5.00</u>		<u>5.00</u>	<u>5.00</u>	<u>5.00</u>	<u>5.00</u>				
<u>MPR</u>	<u>0.60</u>		<u>1.20</u>	<u>1.60</u>	<u>2.00</u>	<u>4.00</u>				
<u>MOD</u>	<u>2.00</u>		<u>2.00</u>	<u>4.00</u>	<u>4.00</u>	<u>6.00</u>				
<u>Rate</u>	<u>3/10</u>		<u>3/5</u>	<u>2/5</u>	<u>1/2</u>	<u>2/3</u>				
<u>Rate</u>	<u>0.30</u>		<u>0.60</u>	<u>0.40</u>	<u>0.50</u>	<u>0.67</u>				
<u>Sch</u>	<u>6.00</u>	<u>6.00</u>	<u>6.00</u>	<u>6.00</u>	<u>6.00</u>	<u>6.00</u>				
<u>MPR</u>	<u>0.50</u>	<u>0.67</u>	<u>1.00</u>	<u>1.33</u>	<u>1.67</u>	<u>3.33</u>				
<u>MOD</u>	<u>2.00</u>	<u>2.00</u>	<u>2.00</u>	<u>2.00</u>	<u>4.00</u>	<u>6.00</u>				
<u>Rate</u>	<u>1/4</u>	<u>1/3</u>	<u>1/2</u>	<u>2/3</u>	<u>5/12</u>	<u>5/9</u>				
<u>Rate</u>	<u>0.25</u>	<u>0.33</u>	<u>0.50</u>	<u>0.67</u>	<u>0.42</u>	<u>0.56</u>				
<u>Sch</u>		<u>8.00</u>		<u>8.00</u>	<u>8.00</u>	<u>8.00</u>	<u>8.00</u>			
<u>MPR</u>		<u>0.50</u>		<u>1.00</u>	<u>1.25</u>	<u>2.50</u>	<u>5.00</u>			
<u>MOD</u>		<u>2.00</u>		<u>2.00</u>	<u>2.00</u>	<u>4.00</u>	<u>6.00</u>			
<u>Rate</u>		<u>1/4</u>		<u>1/2</u>	<u>5/8</u>	<u>5/8</u>	<u>5/6</u>			
<u>Rate</u>		<u>0.25</u>		<u>0.50</u>	<u>0.63</u>	<u>0.63</u>	<u>0.83</u>			
<u>Sch</u>	<u>9.00</u>		<u>9.00</u>				<u>9.00</u>			
<u>MPR</u>	<u>0.33</u>		<u>0.67</u>				<u>4.44</u>			
<u>MOD</u>	<u>2.00</u>		<u>2.00</u>				<u>6.00</u>			
<u>Rate</u>	<u>1/6</u>		<u>1/3</u>				<u>20/27</u>			
<u>Rate</u>	<u>0.17</u>		<u>0.33</u>				<u>0.74</u>			
<u>Sch</u>					<u>10.00</u>	<u>10.00</u>	<u>10.00</u>			
<u>MPR</u>					<u>1.00</u>	<u>2.00</u>	<u>4.00</u>			
<u>MOD</u>					<u>2.00</u>	<u>4.00</u>	<u>6.00</u>			
<u>Rate</u>					<u>1/2</u>	<u>1/2</u>	<u>2/3</u>			
<u>Rate</u>					<u>0.50</u>	<u>0.50</u>	<u>0.67</u>			
<u>Sch</u>	<u>12.00</u>	<u>12.00</u>	<u>12.00</u>	<u>12.00</u>				<u>12.00</u>		

<u>MPR</u>	<u>0.25</u>	<u>0.33</u>	<u>0.50</u>	<u>0.67</u>				<u>5.00</u>		
<u>MOD</u>	<u>2.00</u>	<u>2.00</u>	<u>2.00</u>	<u>2.00</u>				<u>6.00</u>		
<u>Rate</u>	<u>1/8</u>	<u>1/6</u>	<u>1/4</u>	<u>1/3</u>				<u>5/6</u>		
<u>Rate</u>	<u>0.13</u>	<u>0.17</u>	<u>0.25</u>	<u>0.33</u>				<u>0.83</u>		
<u>Sch</u>						<u>13.00</u>	<u>13.00</u>	<u>13.00</u>		
<u>MPR</u>						<u>1.54</u>	<u>3.08</u>	<u>4.62</u>		
<u>MOD</u>						<u>4.00</u>	<u>6.00</u>	<u>6.00</u>		
<u>Rate</u>						<u>5/13</u>	<u>20/39</u>	<u>10/13</u>		
<u>Rate</u>						<u>0.38</u>	<u>0.51</u>	<u>0.77</u>		
<u>Sch</u>					<u>15.00</u>	<u>15.00</u>	<u>15.00</u>	<u>15.00</u>		
<u>MPR</u>					<u>0.67</u>	<u>1.33</u>	<u>2.67</u>	<u>4.00</u>		
<u>MOD</u>					<u>2.00</u>	<u>2.00</u>	<u>4.00</u>	<u>6.00</u>		
<u>Rate</u>					<u>1/3</u>	<u>2/3</u>	<u>2/3</u>	<u>2/3</u>		
<u>Rate</u>					<u>0.33</u>	<u>0.67</u>	<u>0.67</u>	<u>0.67</u>		
<u>Sch</u>		<u>16.00</u>		<u>16.00</u>					<u>16.00</u>	
<u>MPR</u>		<u>0.25</u>		<u>0.50</u>					<u>5.00</u>	
<u>MOD</u>		<u>2.00</u>		<u>2.00</u>					<u>6.00</u>	
<u>Rate</u>		<u>1/8</u>		<u>1/4</u>					<u>5/6</u>	
<u>Rate</u>		<u>0.13</u>		<u>0.25</u>					<u>0.83</u>	
<u>Sch</u>	<u>18.00</u>		<u>18.00</u>						<u>18.00</u>	
<u>MPR</u>	<u>0.17</u>		<u>0.33</u>						<u>4.44</u>	
<u>MOD</u>	<u>2.00</u>		<u>2.00</u>						<u>6.00</u>	
<u>Rate</u>	<u>1/12</u>		<u>1/6</u>						<u>20/27</u>	
<u>Rate</u>	<u>0.08</u>		<u>0.17</u>						<u>0.74</u>	
<u>Sch</u>					<u>20.00</u>	<u>20.00</u>	<u>20.00</u>	<u>20.00</u>	<u>20.00</u>	<u>20.00</u>
<u>MPR</u>					<u>0.50</u>	<u>1.00</u>	<u>2.00</u>	<u>3.00</u>	<u>4.00</u>	<u>5.00</u>
<u>MOD</u>					<u>2.00</u>	<u>2.00</u>	<u>4.00</u>	<u>6.00</u>	<u>6.00</u>	<u>6.00</u>
<u>Rate</u>					<u>1/4</u>	<u>1/2</u>	<u>1/2</u>	<u>1/2</u>	<u>2/3</u>	<u>5/6</u>
<u>Rate</u>					<u>0.25</u>	<u>0.50</u>	<u>0.50</u>	<u>0.50</u>	<u>0.67</u>	<u>0.83</u>
<u>Sch</u>								<u>22.00</u>		<u>22.00</u>
<u>MPR</u>								<u>2.73</u>		<u>4.55</u>
<u>MOD</u>								<u>4.00</u>		<u>6.00</u>
<u>Rate</u>								<u>15/22</u>		<u>25/33</u>
<u>Rate</u>								<u>0.68</u>		<u>0.76</u>
<u>Sch</u>		<u>24.00</u>	<u>24.00</u>	<u>24.00</u>						
<u>MPR</u>		<u>0.17</u>	<u>0.25</u>	<u>0.33</u>						
<u>MOD</u>		<u>2.00</u>	<u>2.00</u>	<u>2.00</u>						
<u>Rate</u>		<u>1/12</u>	<u>1/8</u>	<u>1/6</u>						
<u>Rate</u>		<u>0.08</u>	<u>0.13</u>	<u>0.17</u>						
<u>Sch</u>							<u>26.00</u>		<u>26.00</u>	<u>26.00</u>
<u>MPR</u>							<u>1.54</u>		<u>3.08</u>	<u>3.85</u>
<u>MOD</u>							<u>4.00</u>		<u>6.00</u>	<u>6.00</u>
<u>Rate</u>							<u>5/13</u>		<u>20/39</u>	<u>25/39</u>
<u>Rate</u>							<u>0.38</u>		<u>0.51</u>	<u>0.64</u>
<u>Sch</u>					<u>30.00</u>	<u>30.00</u>	<u>30.00</u>	<u>30.00</u>	<u>30.00</u>	
<u>MPR</u>					<u>0.33</u>	<u>0.67</u>	<u>1.33</u>	<u>2.00</u>	<u>2.67</u>	
<u>MOD</u>					<u>2.00</u>	<u>2.00</u>	<u>2.00</u>	<u>4.00</u>	<u>4.00</u>	
<u>Rate</u>					<u>1/6</u>	<u>1/3</u>	<u>2/3</u>	<u>1/2</u>	<u>2/3</u>	

Sch								<u>240.00</u>	<u>240.00</u>	<u>240.00</u>	
MPR								<u>0.17</u>	<u>0.25</u>	<u>0.33</u>	
MOD								<u>2.00</u>	<u>2.00</u>	<u>2.00</u>	
Rate								<u>1/12</u>	<u>1/8</u>	<u>1/6</u>	
Rate								<u>0.08</u>	<u>0.13</u>	<u>0.17</u>	
Sch											<u>300.00</u>
MPR											<u>0.33</u>
MOD											<u>2.00</u>
Rate											<u>1/6</u>
Rate											<u>0.17</u>
Sch										<u>320.00</u>	
MPR										<u>0.25</u>	
MOD										<u>2.00</u>	
Rate										<u>1/8</u>	
Rate										<u>0.13</u>	
Sch										<u>360.00</u>	
MPR										<u>0.17</u>	
MOD										<u>2.00</u>	
Rate										<u>1/12</u>	
Rate										<u>0.08</u>	
Sch											<u>400.00</u>
MPR											<u>0.25</u>
MOD											<u>2.00</u>
Rate											<u>1/8</u>
Rate											<u>0.13</u>
Sch										<u>480.00</u>	
MPR										<u>0.17</u>	
MOD										<u>2.00</u>	
Rate										<u>1/12</u>	
Rate										<u>0.08</u>	

Table III – N_{EP} Encoding

<u>N_{EP}</u>	<u>48</u>	<u>96</u>	<u>144</u>	<u>192</u>	<u>288</u>	<u>384</u>	<u>480</u>	<u>960</u>	<u>1920</u>	<u>2880</u>	<u>3840</u>	<u>4800</u>	<u>9600</u>	<u>14400</u>	<u>19200</u>	<u>24000</u>
<u>Encoding</u>	<u>0</u>	<u>1</u>	<u>2</u>	<u>3</u>	<u>4</u>	<u>5</u>	<u>6</u>	<u>7</u>	<u>8</u>	<u>9</u>	<u>10</u>	<u>11</u>	<u>12</u>	<u>13</u>	<u>14</u>	<u>15</u>

8.4.9.2.3.6-5.7 Modulation order of UL traffic burst

For UL, the modulation order (2 for QPSK and 4 for 16-QAM) shall be set for all the allowed transmission formats as shown in Table mmm. The transmission format is given by the N_{EP} (Encoding Packet Size) and the N_{SCH} (number of allotted subchannels). N_{EP} per an encoding packet is {48, 96, 144, 192, 288, 384, 480, 960, 1920, 2880, 3840, 4800}. The N_{SCH} per an encoding packet is {1~288}. In the table, the numbers in the first row are N_{EP} 's and the numbers in the remaining rows are N_{SCH} 's and related parameters.

The supportable modulation schemes are QPSK and 16QAM. When the N_{EP} and the N_{SCH} are given, the modulation order is determined by the value of MPR (Modulation order Product code Rate). The MPR means the effective number of the information bit transmitted per subcarrier and is defined as follows.

$$MPR = \frac{N_{EP}}{48 \cdot N_{SCH}}$$

Then, the modulation order is specified by the following rule:

- i) If $0 < MPR < 1.5$, then a QPSK (modulation order 2) is used
- ii) If $1.5 \leq MPR < 3.4$, then a 16QAM (modulation order 4) is used

The effective code rate is equal to MPR divided by the modulation order (i.e. 2 for QPSK).

In H-ARQ_UL allocation_IE{} for UL of DL-UL MAP, N_{EP} is encoded by 4 bit field as shown in Table III where encoding is presented with decimal value. N_{SCH} can be derived from H-ARQ_UL allocation_IE{}.

When the values of N_{EP} are $n \cdot 4800$, the actual encoding packet size (N_{EP}) is 4800 and this value is applied for the calculation of subpacket length in 8.4.9.2.3.4.3 Symbol selection subclause and MPR in this subclause. Let N_{sch_total} be the number of subchannels allocated to the burst divided by n . When the divided number is not the integer, N_{sch_total} is the largest integer smaller than the divided.

N_{SCH} is same as the largest number that is smaller than N_{sch_total} in the column of the actual encoding packet size (N_{EP}) in table kkk.

Table mmm – Transmission format and modulation level for UL

<u>Nep</u>	<u>48</u>	<u>96</u>	<u>144</u>	<u>192</u>	<u>288</u>	<u>384</u>	<u>480</u>	<u>960</u>	<u>1920</u>	<u>2880</u>	<u>3840</u>	<u>4800</u>
<u>Sch</u>	<u>1.00</u>	<u>1.00</u>	<u>1.00</u>									
<u>MPR</u>	<u>1.00</u>	<u>2.00</u>	<u>3.00</u>									
<u>MOD</u>	<u>2.00</u>	<u>4.00</u>	<u>4.00</u>									
<u>Rate</u>	<u>1/2</u>	<u>1/2</u>	<u>3/4</u>									
<u>Rate</u>	<u>0.50</u>	<u>0.50</u>	<u>0.75</u>									
<u>Sch</u>	<u>2.00</u>	<u>2.00</u>	<u>2.00</u>	<u>2.00</u>	<u>2.00</u>							
<u>MPR</u>	<u>0.50</u>	<u>1.00</u>	<u>1.50</u>	<u>2.00</u>	<u>3.00</u>							
<u>MOD</u>	<u>2.00</u>	<u>2.00</u>	<u>4.00</u>	<u>4.00</u>	<u>4.00</u>							
<u>Rate</u>	<u>1/4</u>	<u>1/2</u>	<u>3/8</u>	<u>1/2</u>	<u>3/4</u>							
<u>Rate</u>	<u>0.25</u>	<u>0.50</u>	<u>0.38</u>	<u>0.50</u>	<u>0.75</u>							
<u>Sch</u>	<u>3.00</u>	<u>3.00</u>	<u>3.00</u>	<u>3.00</u>	<u>3.00</u>	<u>3.00</u>	<u>3.00</u>					
<u>MPR</u>	<u>0.33</u>	<u>0.67</u>	<u>1.00</u>	<u>1.33</u>	<u>2.00</u>	<u>2.67</u>	<u>3.33</u>					
<u>MOD</u>	<u>2.00</u>	<u>2.00</u>	<u>2.00</u>	<u>2.00</u>	<u>4.00</u>	<u>4.00</u>	<u>4.00</u>					
<u>Rate</u>	<u>1/6</u>	<u>1/3</u>	<u>1/2</u>	<u>2/3</u>	<u>1/2</u>	<u>2/3</u>	<u>5/6</u>					
<u>Rate</u>	<u>0.17</u>	<u>0.33</u>	<u>0.50</u>	<u>0.67</u>	<u>0.50</u>	<u>0.67</u>	<u>0.83</u>					
<u>Sch</u>	<u>4.00</u>	<u>4.00</u>		<u>4.00</u>	<u>4.00</u>	<u>4.00</u>	<u>4.00</u>					
<u>MPR</u>	<u>0.25</u>	<u>0.50</u>		<u>1.00</u>	<u>1.50</u>	<u>2.00</u>	<u>2.50</u>					
<u>MOD</u>	<u>2.00</u>	<u>2.00</u>		<u>2.00</u>	<u>4.00</u>	<u>4.00</u>	<u>4.00</u>					
<u>Rate</u>	<u>1/8</u>	<u>1/4</u>		<u>1/2</u>	<u>3/8</u>	<u>1/2</u>	<u>5/8</u>					
<u>Rate</u>	<u>0.13</u>	<u>0.25</u>		<u>0.50</u>	<u>0.38</u>	<u>0.50</u>	<u>0.63</u>					

Sch			<u>5.00</u>		<u>5.00</u>	<u>5.00</u>	<u>5.00</u>					
MPR			<u>0.60</u>		<u>1.20</u>	<u>1.60</u>	<u>2.00</u>					
MOD			<u>2.00</u>		<u>2.00</u>	<u>4.00</u>	<u>4.00</u>					
Rate			<u>3/10</u>		<u>3/5</u>	<u>2/5</u>	<u>1/2</u>					
Rate			<u>0.30</u>		<u>0.60</u>	<u>0.40</u>	<u>0.50</u>					
Sch	<u>6.00</u>	<u>6.00</u>	<u>6.00</u>	<u>6.00</u>	<u>6.00</u>	<u>6.00</u>	<u>6.00</u>	<u>6.00</u>				
MPR	<u>0.17</u>	<u>0.33</u>	<u>0.50</u>	<u>0.67</u>	<u>1.00</u>	<u>1.33</u>	<u>1.67</u>	<u>3.33</u>				
MOD	<u>2.00</u>	<u>2.00</u>	<u>2.00</u>	<u>2.00</u>	<u>2.00</u>	<u>2.00</u>	<u>4.00</u>	<u>4.00</u>				
Rate	<u>1/12</u>	<u>1/6</u>	<u>1/4</u>	<u>1/3</u>	<u>1/2</u>	<u>2/3</u>	<u>5/12</u>	<u>5/6</u>				
Rate	<u>0.08</u>	<u>0.17</u>	<u>0.25</u>	<u>0.33</u>	<u>0.50</u>	<u>0.67</u>	<u>0.42</u>	<u>0.83</u>				
Sch								<u>7.00</u>				
MPR								<u>2.86</u>				
MOD								<u>4.00</u>				
Rate								<u>5/7</u>				
Rate								<u>0.714</u>				
Sch		<u>8.00</u>		<u>8.00</u>		<u>8.00</u>	<u>8.00</u>	<u>8.00</u>				
MPR		<u>0.25</u>		<u>0.50</u>		<u>1.00</u>	<u>1.25</u>	<u>2.50</u>				
MOD		<u>2.00</u>		<u>2.00</u>		<u>2.00</u>	<u>2.00</u>	<u>4.00</u>				
Rate		<u>1/8</u>		<u>1/4</u>		<u>1/2</u>	<u>5/8</u>	<u>5/8</u>				
Rate		<u>0.13</u>		<u>0.25</u>		<u>0.50</u>	<u>0.625</u>	<u>0.625</u>				
Sch			<u>9.00</u>		<u>9.00</u>							
MPR			<u>0.33</u>		<u>0.67</u>							
MOD			<u>2.00</u>		<u>2.00</u>							
Rate			<u>1/6</u>		<u>1/3</u>							
Rate			<u>0.17</u>		<u>0.33</u>							
Sch							<u>10.00</u>	<u>10.00</u>				
MPR							<u>1.00</u>	<u>2.00</u>				
MOD							<u>2.00</u>	<u>4.00</u>				
Rate							<u>1/2</u>	<u>1/2</u>				
Rate							<u>0.50</u>	<u>0.50</u>				
Sch		<u>12.00</u>	<u>12.00</u>	<u>12.00</u>	<u>12.00</u>	<u>12.00</u>			<u>12.00</u>			
MPR		<u>0.17</u>	<u>0.25</u>	<u>0.33</u>	<u>0.50</u>	<u>0.67</u>			<u>3.33</u>			
MOD		<u>2.00</u>	<u>2.00</u>	<u>2.00</u>	<u>2.00</u>	<u>2.00</u>			<u>4.00</u>			
Rate		<u>1/12</u>	<u>1/8</u>	<u>1/6</u>	<u>1/4</u>	<u>1/3</u>			<u>5/6</u>			
Rate		<u>0.08</u>	<u>0.13</u>	<u>0.17</u>	<u>0.25</u>	<u>0.33</u>			<u>0.83</u>			
Sch									<u>13.00</u>			
MPR									<u>3.08</u>			
MOD									<u>4.00</u>			
Rate									<u>10/13</u>			
Rate									<u>0.77</u>			
Sch							<u>15.00</u>	<u>15.00</u>	<u>15.00</u>			
MPR							<u>0.67</u>	<u>1.33</u>	<u>2.67</u>			
MOD							<u>2.00</u>	<u>2.00</u>	<u>4.00</u>			
Rate							<u>1/3</u>	<u>2/3</u>	<u>2/3</u>			
Rate							<u>0.33</u>	<u>0.67</u>	<u>0.67</u>			
Sch				<u>16.00</u>		<u>16.00</u>						
MPR				<u>0.25</u>		<u>0.50</u>						
MOD				<u>2.00</u>		<u>2.00</u>						

Sch							<u>40.00</u>	<u>40.00</u>	<u>40.00</u>	<u>40.00</u>	<u>40.00</u>		
MPR							<u>0.25</u>	<u>0.50</u>	<u>1.00</u>	<u>1.50</u>	<u>2.00</u>		
MOD							<u>2.00</u>	<u>2.00</u>	<u>2.00</u>	<u>4.00</u>	<u>4.00</u>		
Rate							<u>1/8</u>	<u>1/4</u>	<u>1/2</u>	<u>3/8</u>	<u>1/2</u>		
Rate							<u>0.13</u>	<u>0.25</u>	<u>0.50</u>	<u>0.38</u>	<u>0.50</u>		
Sch										<u>45.00</u>			
MPR										<u>1.33</u>			
MOD										<u>2.00</u>			
Rate										<u>2/3</u>			
Rate										<u>0.67</u>			
Sch						<u>48.00</u>							
MPR						<u>0.17</u>							
MOD						<u>2.00</u>							
Rate						<u>1/12</u>							
Rate						<u>0.08</u>							
Sch													<u>50.00</u>
MPR													<u>2.00</u>
MOD													<u>4.00</u>
Rate													<u>1/2</u>
Rate													<u>0.50</u>
Sch											<u>53.00</u>		
MPR											<u>1.51</u>		
MOD											<u>4.00</u>		
Rate											<u>20/53</u>		
Rate											<u>0.377</u>		
											<u>4</u>		
Sch							<u>60.00</u>	<u>60.00</u>	<u>60.00</u>	<u>60.00</u>	<u>60.00</u>		
MPR							<u>0.17</u>	<u>0.33</u>	<u>0.67</u>	<u>1.00</u>	<u>1.33</u>		
MOD							<u>2.00</u>	<u>2.00</u>	<u>2.00</u>	<u>2.00</u>	<u>2.00</u>		
Rate							<u>1/12</u>	<u>1/6</u>	<u>1/3</u>	<u>1/2</u>	<u>2/3</u>		
Rate							<u>0.08</u>	<u>0.17</u>	<u>0.33</u>	<u>0.50</u>	<u>0.67</u>		
Sch													<u>66.00</u>
MPR													<u>1.52</u>
MOD													<u>4.00</u>
Rate													<u>25/66</u>
Rate													<u>0.38</u>
Sch													<u>75.00</u>
MPR													<u>1.33</u>
MOD													<u>2.00</u>
Rate													<u>2/3</u>
Rate													<u>0.67</u>
Sch								<u>80.00</u>	<u>80.00</u>		<u>80.00</u>		
MPR								<u>0.25</u>	<u>0.50</u>		<u>1.00</u>		
MOD								<u>2.00</u>	<u>2.00</u>		<u>2.00</u>		
Rate								<u>1/8</u>	<u>1/4</u>		<u>1/2</u>		
Rate								<u>0.13</u>	<u>0.25</u>		<u>0.50</u>		
Sch										<u>90.00</u>			
MPR										<u>0.67</u>			

<u>MOD</u>										<u>2.00</u>		
<u>Rate</u>										<u>1/3</u>		
<u>Rate</u>										<u>0.33</u>		
<u>Sch</u>												<u>100.0</u>
<u>MPR</u>												<u>0</u>
<u>MOD</u>												<u>1.00</u>
<u>Rate</u>												<u>2.00</u>
<u>Rate</u>												<u>1/2</u>
<u>Rate</u>												<u>0.50</u>
<u>Sch</u>								<u>120.0</u>	<u>120.0</u>	<u>120.0</u>	<u>120.0</u>	
<u>MPR</u>								<u>0</u>	<u>0</u>	<u>0</u>	<u>0</u>	
<u>MOD</u>								<u>0.17</u>	<u>0.33</u>	<u>0.50</u>	<u>0.67</u>	
<u>Rate</u>								<u>2.00</u>	<u>2.00</u>	<u>2.00</u>	<u>2.00</u>	
<u>Rate</u>								<u>1/12</u>	<u>1/6</u>	<u>1/4</u>	<u>1/3</u>	
<u>Rate</u>								<u>0.08</u>	<u>0.17</u>	<u>0.25</u>	<u>0.33</u>	
<u>Sch</u>												<u>150.0</u>
<u>MPR</u>												<u>0</u>
<u>MOD</u>												<u>0.67</u>
<u>Rate</u>												<u>2.00</u>
<u>Rate</u>												<u>1/3</u>
<u>Rate</u>												<u>0.33</u>
<u>Sch</u>									<u>160.0</u>		<u>160.0</u>	
<u>MPR</u>									<u>0</u>		<u>0</u>	
<u>MOD</u>									<u>0.25</u>		<u>0.50</u>	
<u>Rate</u>									<u>2.00</u>		<u>2.00</u>	
<u>Rate</u>									<u>1/8</u>		<u>1/4</u>	
<u>Rate</u>									<u>0.13</u>		<u>0.25</u>	
<u>Sch</u>										<u>180.0</u>		
<u>MPR</u>										<u>0</u>		
<u>MOD</u>										<u>0.33</u>		
<u>Rate</u>										<u>2.00</u>		
<u>Rate</u>										<u>1/6</u>		
<u>Rate</u>										<u>0.17</u>		
<u>Sch</u>												<u>200.0</u>
<u>MPR</u>												<u>0.50</u>
<u>MOD</u>												<u>2.00</u>
<u>Rate</u>												<u>1/4</u>
<u>Rate</u>												<u>0.25</u>
<u>Sch</u>									<u>240.0</u>	<u>240.0</u>	<u>240.0</u>	
<u>MPR</u>									<u>0.17</u>	<u>0.25</u>	<u>0.33</u>	
<u>MOD</u>									<u>2.00</u>	<u>2.00</u>	<u>2.00</u>	
<u>Rate</u>									<u>1/12</u>	<u>1/8</u>	<u>1/6</u>	
<u>Rate</u>									<u>0.08</u>	<u>0.13</u>	<u>0.17</u>	

In page 480, line 50, Add a new sections as shown below:

8.4.5.3.8 H-ARQ DL allocation IE

When the H-ARQ feature is applied to a burst, DIUC=15 with H-ARQ_DL allocation_IE{} shall be used for the physical allocation of the burst.

Table nnn— H-ARQ DL allocation extended IE

<u>Syntax</u>	<u>Size</u>	<u>Notes</u>
H-ARQ_DL allocation_IE{		
Extended DIUC	4 bits	H-ARQ_DL Allocation = 0x05
Length	4 bits	Length = 0x05
Nep	4 bits	Encoding Packet size (see 8.4.9.2.3.6.4)
OFDMA Symbol offset	8 bits	
Subchannel offset	6 bits	
Boosting	3 bits	000: normal (not boosted); 001: +6dB; 010: -6dB; 011: +9dB; 100: +3dB; 101: -3dB; 110: -9dB; 111: -12dB;
No. OFDMA Symbols	7 bits	
No. Subchannels	6 bits	
SPID	2 bits	Subpacket ID
ACID	3 bits	ARQ channel ID
AI_SN	1 bits	Continuation bit
}		

8.4.5.3.9 H-ARQ ACK bitmap IE

The H-ARQ_ACK Bitmap IE format is presented in Table ppp. This IE is located in the DL-MAP. A BS may use this IE to transmit acknowledgement for the H-ARQ enabled UL bursts using the one bit in the bitmap. The bit offset in the bitmap is determined by the order of the H-ARQ enabled UL bursts in a previous UL-MAP according to the H-ARQ DL ACK delay offset TLV.

Table ppp— H-ARQ ACK bitmap IE

<u>Syntax</u>	<u>Size</u>	<u>Notes</u>
H-ARQ-ACK-Bitmap_IE () {		
extended DIUC	4 bits	H-ARQ ACK bitmap = 0x06
Length	4 bits	Variable length
Bitmap	variable	Bitmap length should be an integer number of bytes, smaller or equal to 15
}		

In the bitmap field, a value of '1' indicates ACK and a value of '0' indicates NACK.

In page 488, line 43, Add a new section as shown below:

8.4.5.4.9 H-ARQ UL allocation extended IE

When the H-ARQ feature is applied to a burst, DIUC=15 with H-ARQ_UL_allocation_IE{} shall be used for the physical allocation of the burst.

Table 000— H-ARQ UL allocation extended IE

<u>Syntax</u>	<u>Size</u>	<u>Notes</u>
H-ARQ_UL_allocation_IE{		
Extended DIUC	4 bits	H-ARQ_UL_Allocation = 0x03
Length	4 bits	Length = 0x03
Nep	4 bits	Encoding Packet size (see 8.4.9.2.3.6.5)
Duration	10 bits	In OFDMA slots (see 8.4.3.1)
SPID	2 bits	Subpacket ID
ACID	3 bits	ARQ channel ID
AI_SN	1 bits	Continuation bit
Reserved	4 bits	
}		

In page 589, line 31, Add a new line to the table as shown below:

Table 317—DCD burst profile encodings—WirelessMAN-OFDMA

<u>Name</u>	<u>Type (1 byte)</u>	<u>Length</u>	<u>Value (variable length)</u>
H-ARQ DL ACK delay offset	154	1	0 = 0 frame offset 1 = 1 frame offset 2 = 2 frame offset

In page 243, line 41, modify the text to read:

6.4.167 MAC support for H-ARQ

Hybrid automatic repeat request (H-ARQ) scheme is an optional part of the MAC and can be enabled on a per-terminal basis. The per-terminal H-ARQ and associated parameters shall be specified and negotiated during initialization procedure. A terminal cannot have a mixture of H-ARQ and non-H-ARQ traffic.

One or more MAC PDUs can be concatenated and an H-ARQ packet formed by adding a CRC to the PHY burst. Figure 125 shows how the H-ARQ encoder packet is constructed.

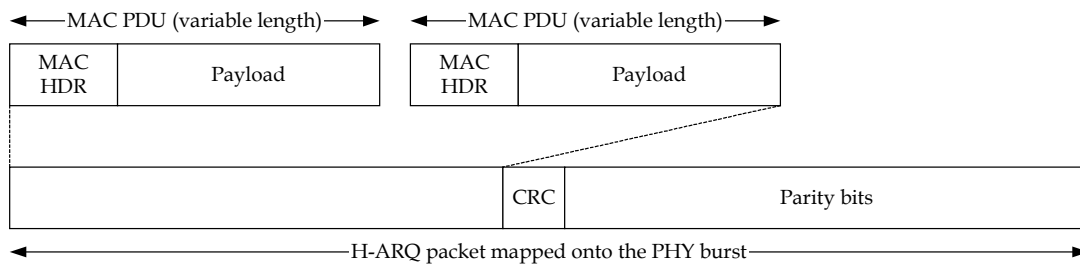

Figure 125—Construction of H-ARQ encoder packet

Each encoder packet is encoded according to the PHY specification, and four subpackets are generated from the encoded result. A subpacket identifier (SPID) is used to distinguish the four subpackets. In case of downlink communication, a BS can send one of the subpackets in a burst transmission. Because of the redundancy among the subpackets, SS can correctly decode the original encoder packet even before it receives all four subpackets. Whenever receiving the first subpacket, the SS attempts to decode the original encoder packet from it. If it succeeds, the SS sends an ACK to the BS, so that the BS stops sending additional subpackets of the encoder packet. Otherwise, the SS sends a NAK, which causes the BS to transmit one subpacket selected from the four. These procedures go on until the SS successfully decodes the encoder packet. When the SS receives more than one subpacket, it tries to decode the encoder packet from ever-received subpackets.

The rule of subpacket transmission is as follows.

1. At the first transmission, BS shall send the subpacket labeled '00'.
2. BS may send one among subpackets labeled '00', '01', '10', or '11' in any order, ~~as long as the total number of transmitted subpackets does not exceed the maximum number of H-ARQ retransmission specified in CD message~~.
3. BS can send more than one copy of any subpacket, and can omit any subpacket except the subpacket labeled '00'.

In order to specify the start of a new transmission, one-bit H-ARQ identifier sequence number (AI_SN) is toggled on every successful transmission of an encoder packet on the same H-ARQ channel. If the AI_SN changes, the receiver treats the corresponding subpacket as a subpacket belongs to a new encoder packet, and discards ever-received subpackets with the same ARQ identifier.

The H-ARQ scheme is basically a stop-and-wait protocol. The ACK is sent by the SS after a fixed delay (synchronous ACK) defined by ~~H-ARQ_ACK_DELAY~~ [H-ARQ DL ACK delay offset](#) which is specified in [DCD](#) message. Timing of retransmission is, however, flexible and corresponds to the asynchronous part of the H-ARQ. The ACK/NAK is ~~a differential binary PSK modulated signal sent by the SS~~ [sent by the BS using the H-ARQ Bitmap IE, and sent by a SS using the fast feedback UL subchannel.](#)

The H-ARQ scheme supports multiple H-ARQ channels per a connection, each of which may have an encoder packet transaction pending. The number of H-ARQ channels in use is determined by BS. These ARQ channels are distinguished by an H-ARQ channel identifier (ACID). The ACID for any subpackets can be uniquely identified by the control information carried in the MAPs.

H-ARQ (Hybrid Automatic Repeat reQuest) can be used to mitigate the effect of channel and interference fluctuation. H-ARQ renders performance improvement due to SNR gain and time diversity achieved by combining previously erroneously decoded packet and retransmitted packet, and due to additional coding gain by IR (Incremental Redundancy).

6.4.17.1 Subpacket generation

H-ARQ operates at the FEC block level. The FEC encoder is responsible for generating the H-ARQ subpackets, as defined in the relevant PHY section. The subpackets are combined by the receiver FEC decoder as part of the decoding process.

6.4.17.2 DL/UL ACK/NAK signaling

For DL/UL H-ARQ, fast ACK/NAK signaling is necessary. For the fast ACK/NAK signaling of DL H-ARQ channel, a dedicated PHY layer ACK/NAK channel is designed in UL. For the fast ACK/NAK signaling of UL ~~H-ARQ channel~~ fast feedback, H-ARQ ACK message is designed.

6.4.17.3 H-ARQ parameter signaling

The parameters for each subpacket should be signaled independent of the subpacket burst itself. The parameters for each subpacket include SPID (Subpacket Identifier. The BS shall set this field to the subpacket identifier for the subpacket transmission.), ACID (ARQ Channel Identifier. The BS shall set this field to the ARQ channel identifier for the subpacket transmission.), and AI_SN (ARQ identifier sequence number. This toggles between '0' and '1' on successfully transmitting each encoder packet with the same ARQ channel.). For the signaling of those parameters, H-ARQ Allocation IE is defined and the IE is to be placed in a DL-MAP or UL-MAP for a burst where H-ARQ is used.

6.4.17.4 CQICH Operations

This section describes the operation scenarios and requirements of CQICH, which is designed for H-ARQ enabled SS. After an SS turns on its power, the only appropriate subchannels that can be allocated to the MSS are normal subchannels. To determine the M/C level of normal subchannels, the average CINR measurement is enough for the BS to determine the M/C levels of uplink and downlink. As soon as the BS and the MSS know the capabilities of both entities' modulation and coding, the BS may allocate a CQICH subchannel using a CQICH Control IE (see 8.4.5.x.x.2 CQICH Control IE). Then, the MSS reports the average CINR of the BS' preamble. From then on, the BS is able to determine the M/C level. A CINR measurement is quantized into 32 levels and encoded into 5 information bits.

At any time, the BS may de-allocate the SS' CQICH by putting another CQICH Control IE with Duration $d = 0000$. Before the CQICH life timer which is set at the receipt of the CQICH Control IE expires, sending another CQICH Control IE overwrites all the information related to the CQICH such as Allocation Index, Period, Frame offset, and Duration. Hence, unless the BS refreshes the timer, the SS should stop reporting as soon as the timer expires. However, in case of sending the MAP IE for re-allocation or de-allocation, the BS should make sure if the previous CQICH is released before it is re-allocated to another SS.

The SS sends the REP-RSP message in an unsolicited fashion to BS to trigger Band AMC operation. The triggering conditions are given by TLV encodings in UCD messages. The REP-RSP (see 11.12 for the TLV encodings) includes the CINR measurements of five best bands. Only when an SS reports its BS the CINR measurements of Band AMC channels, its logical definition is differently made as follows. If the number of bands is less than or equal to 12, it is the same as the original one. However, if it is 24 (1024 FFT in 10 MHz), two contiguous bands are paired and 12 logical bands are newly defined. Hence, band $2n$ and band $(2n+1)$ are paired and the paired band is the n -th band. If the number of bands is 48 (2048 FFT in 20 MHz), the two contiguous bands are paired and renumbered the same as a 24 band system. Then, if the LSB of an SS' MAC address is 1, it only uses the odd-numbered bands. If not, it only uses the even-numbered bands. Hence, for example, the LSB of an SS' MAC address is 1, $(4m+2, 4m+3)$ bands are paired and the paired band is the m -th band of the SS. Similarly, for an even-numbered SS, $(4m, 4m+1)$ bands are paired and the paired band is the m -th band of the SS.

The BS acknowledges the trigger by allocating Band AMC subchannels. From then on, the SS reports the BS the differential CINR of five selected bands (increment: 1 and decrement: 0 with a step of 1 dB).

When the BS wants to trigger the transition to Band AMC mode or update the CINR reports, it sends the REP-REQ message (see 11.11 for the TLV encodings). When the SS receives the message, it replies with REP-RSP. When the BS receives the REP-RSP, it should synchronize the selection of bands reported and their CINR. Unless the BS allocates normal subchannels, the SS reports the differential increment compared to the most up-to-date report from the next CQI reporting frame.

In page 480, line 50, add the following text:

8.4.5.3.8 H-ARQ MAP Pointer IE

Table 255—H-ARQ MAP Pointer IE

<u>Syntax</u>	<u>Size</u>	<u>Notes</u>
H-ARQ_Pointer_DL_IE () {	-	-
Extended DIUC	4 bits	<u>H-ARQ MAP pointer = 0x05</u>
Length	4 bit	<u>Length = 0x02</u>
AMC DIUC	4 bits	<u>Indicates the AMC level of the burst containing a H-ARQ MAP message.</u>
No. Slots	8 bits	<u>The number of slots allocated for the burst containing a H-ARQ MAP message.</u>
Reserved	4 bits	
}		

AMC DIUC

Indicates the burst profile used for the H-ARQ MAP message.

No. Slots

The number of OFDMA slots allocated for the burst containing a H-ARQ MAP message. The H-ARQ MAP message shall directly follows the DL MAP, the number of the slots allocated for the H-ARQ MAP message.

In page 104, line 21, add the following text:

6.3.2.3.44 H-ARQ MAP message

This section describes the H-ARQ MAP, which is designed for H-ARQ enabled SS. This message shall only be implemented by SS and BS that support H-ARQ.

6.3.2.3.44.1 H-ARQ MAP message format

The H-ARQ MAP message format is presented in Table 1. This message includes Compact DL/UL-MAP IE and defines the access information for the downlink and uplink burst of H-ARQ enabled SS. This message shall be sent without a generic MAC header. BS may broadcast multiple H-ARQ MAP messages using multiple burst after the MAP message. Each H-ARQ MAP message should have a different modulation and coding rate. If the frame contains DCD or UCD message following the MAP message, the H-ARQ MAP should follow DCD or UCD message.

The DL-MAP IEs in the MAP message describe the location and coding and modulation schemes of the bursts. The order of DL-MAP IEs in the MAP message and the bursts for H-ARQ MAP messages is determined by the coding and modulation scheme of the burst. The burst for H-ARQ MAP message with lower rate coding and modulation should be placed before other bursts for H-ARQ MAP message.

The presence of the H-ARQ MAP message format is indicated by the contents of the three most significant bits of the first data byte of a burst. These bytes overlay the HT and EC bits of a generic MAC header. When these bits are both set to 1 (an invalid combination for a standard header) and followed by 1 bits of 1, the Compact DL-MAP format is present.

Table 1 Format of H-ARQ MAP

<u>Syntax</u>	<u>Size</u>	<u>Notes</u>
<u>H-ARQ MAP Message Format () {</u>	-	-
<u> H-ARQ MAP Indicator = 111</u>	<u>3 bits</u>	<u>Set to binary 111</u>
<u> H-ARQ_UL-MAP appended</u>	<u>1 bit</u>	-
<u> CRC appended</u>	<u>1 bit</u>	-
<u> Map message length</u>	<u>9 bits</u>	<u>Length of H-ARQ MAP in bytes</u>
<u> DL IE count</u>	<u>6 bits</u>	<u>Number of DL IE in the burst</u>
<u> for (i=0; i < DL IE count; i++){</u>	-	-
<u> Compact_DL-MAP IE()</u>	<u>variable</u>	-
<u> }</u>	-	-
<u> If (Compact_UL-MAP appended ==1){</u>	-	-
<u> while (map data remains) {</u>	-	-
<u> Compact_UL-MAP IE()</u>	<u>variable</u>	-
<u> }</u>	-	-
<u> }</u>	-	-
<u> if !(byte boundary) {</u>	-	-
<u> Padding bits</u>	<u>1</u>	-
<u> }</u>	-	-
<u>}</u>	-	-

H-ARQ MAP Indicator

The value of binary 111 means this message is a H-ARQ MAP Message

Compact UL-MAP appended

A value of 1 indicates a compact UL-MAP is appended to the current compact DL-MAP data structure

CRC appended

A value of one indicates a CRC-32 value is appended to the end of the H-ARQ MAP data. The CRC is computed across all bytes of the H-ARQ MAP starting with the byte containing the H-ARQ MAP indicator through the last byte of the map as specified by the Map message length field. The CRC calculation is the same as that used for standard MAC messages. A value of zero indicates that no CRC is appended.

MAP message length

This value specifies the length of the H-ARQ MAP message beginning with the byte containing the H-ARQ MAP indicator and ending with the last byte of the H-ARQ MAP message. The length includes the computed 32-bit CRC

value if the CRC appended indicator is on.

DL IE count

This field holds the number of IE entries in the following list of DL-MAP IEs.

Table 2 and Table 3 represent the types of compact DL/UL MAP.

Table 2 Compact DL-MAP IE Types

<u>Compact DL-MAP Type</u>	<u>Description</u>
<u>0</u>	<u>Normal subchannel</u>
<u>1</u>	<u>Band AMC</u>
<u>2</u>	<u>Safety</u>
<u>3</u>	<u>DIUC</u>
<u>4</u>	<u>Format Configuration IE</u>
<u>5</u>	<u>H-ARQ ACK BITMAP IE</u>
<u>6</u>	<u>Reserved</u>
<u>7</u>	<u>Extension</u>

Table 3 Compact UL-MAP IE Types

<u>Compact UL-MAP Type</u>	<u>Description</u>
<u>0</u>	<u>Normal subchannel</u>
<u>1</u>	<u>Band AMC</u>
<u>2</u>	<u>Safety</u>
<u>3</u>	<u>UIUC</u>
<u>4</u>	<u>H-ARQ Region IE</u>
<u>5</u>	<u>COI Region IE</u>
<u>6</u>	<u>Reserved</u>
<u>7</u>	<u>Extension</u>

6.3.2.3.44.2 Format Configuration

Table 4 represents the format of Format Configuration IE that configures CID type, safety pattern, maximum logical bands and frame structure. The format should be set to default value at the start of each frame.

Table 4 Format Configuration IE

<u>Syntax</u>	<u>Size</u>	<u>Notes</u>
<u>Compact_DL-MAP_IE() {</u>		
<u>DL-MAP Type = 4</u>	<u>3 bits</u>	<u>Format Configuration IE</u>
<u>New Format Indication</u>	<u>1 bits</u>	<u>0 = Use the format configured by the latest</u> <u>Format Configuration IE</u> <u>1 = New format</u>
<u>if (New Format Indication == 1) {</u>		
<u>CID Type</u>	<u>3 bits</u>	<u>00 = Normal CID</u> <u>01 = RCID11 (default)</u> <u>10 = RCID7</u> <u>11 = RCID3</u>
<u>Safety Pattern</u>	<u>5 bits</u>	<u>Range of value 0~23</u>
<u>Reserved</u>	<u>2 bit</u>	
<u>Max Logical Bands</u>	<u>2 bits</u>	<u>0 = 3 bands,</u> <u>1 = 6 bands,</u>

		2 = 12 bands (default) 3 = 24 bands
No. Symbols for DL Normal subchannel	4 bits	No. Symbol
No. Symbols for DL Band	4 bits	No. Symbol
No. Symbols for Broadcast	4 bits	No. Symbol
No. Symbols for UL Normal subchannel	4 bits	No. Symbol
No. Symbols for UL Bands	4 bits	No. Symbol
}		
}		

New Format Indication

If this value set to 0, the format should be configured by the latest Format Configuration IE in the previous frames. Otherwise, whole parameters in Format Configuration IE should be configured. The configured parameters are valid for the following Compact DL/UL MAP IE.

At the start of each frame all parameters are set to default values.

CID Type

This value specifies CID type used in the Compact DL/UL MAP IE.

No. Symbols for DL Normal subchannel

This specifies the number of symbols allocated for DL Normal subchannel.

No. Symbols for DL Band

This specifies the number of symbols allocated for DL Band AMC subchannel.

No. Symbols for Broadcast

This specifies the number of symbols allocated for Broadcast subchannel.

No. Symbols for UL Normal subchannel

This specifies the number of symbols allocated for UL Normal subchannel.

No. Symbols for UL Band

This specifies the number of symbols allocated for UL Band AMC subchannel.

Safety Pattern

If this value is less than 16, the number of safety bins is 12 and the indices of allocated bins for safety are $16m+x$, where x is the value of Safety Pattern and $m = 0 \sim 11$. If this value is not less than 16, the number of safety bins is 24 and the indices of allocated bins for safety are $16m+x'$ and $16m+(x'+8)$, where $x' = x - 16$ and $m = 0 \sim 11$.

Max Logical Bands

This value specifies the maximum number of logical bands for Band AMC. The size of 3 fields (No. Selected Bands, Band BITMAP and Band Index) in the DL/UL-MAP IE for Bands AMC depends on this value. Table 5 represents the fields in the DL/UL-MAP IE and specific values.

Table 5 Field length for Band AMC MAP IE

Logical Bands	24 bands	12 bands	6 bands	3 bands
Max Logical Bands	11	10	01	00
Nb-Band (# of bits for No. Selected Bands)	4 bits	4 bits	4 bits	0 bits
Nb-BITMAP (# of bits for Band BITMAP)	24 bits	12 bits	8 bits	4 bits
Nb-Index (# of bits for Band Index)	8 bits	4 bits	4 bits	0 bits

6.3.2.3.44.3 Reduced CID

Table 6 presents the format of reduced CID. BS may use reduced CID instead of basic CID or multicast CID to reduce the size of H-ARQ MAP message. The type of reduced CID is determined by BS considering the range of basic CIDs of SS connected with the BS and specified by the RCID_Type field of the Format Configuration IE.

The reduced CID is composed of 1 bit of prefix and n-bits of LSB of CID of SS. The prefix is set to 1 for the broadcast CID or multicast CID and set to 0 for basic CID. The reduced CID can not be used instead of transport CID, primary management CID or secondary management CID.

Figure 1 shows the decoding of reduced CID when the RCID_Type is set to 3.

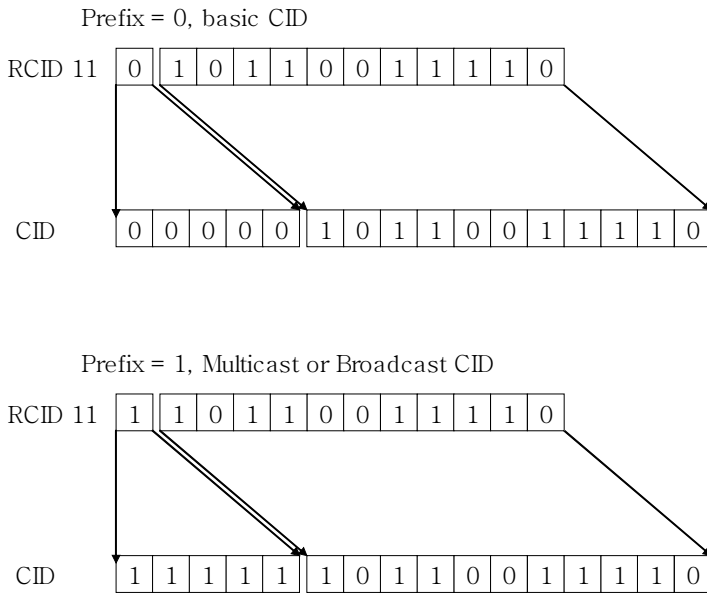

Figure 1 Reduced CID Decoding

Table 6 RCID_IE format

Syntax	Size	Notes
RCID_IE () {	-	Support of Reduced CID
if (RCID_Type == 0) {	-	RCID_Type is specified in Format Configuration IE
CID	16	normal CID
} else {	-	-
Prefix	1	for multicast, AAS, Padding & broadcast burst temporary disable RCID
if (Prefix == 1) {	-	-
RCID 11	11	11 LSB of multicast, AAS or broadcast CID
} else {	-	-
if (RCID_Type == 1) {	-	-
RCID 11	11	11 LSB of basic CID
} else if (RCID_Type == 2) {	-	-
RCID 7	7	7 LSB of basic CID
} else if (RCID_Type == 3) {	-	-
RCID 3	3	3 LSB of basic CID
}	-	-
}	-	-
}	-	-

CID

Normal 16 bits CID

Prefix

A value of one indicates that 11 bits RCID for broadcast and multicast follows the prefix. Otherwise, the n-bits RCID for basic CID follows the prefix. The value of n is determined by the RCID_Type field in Format_Configuration_IE.

RCID n

n-bits LSB of CID

6.3.2.3.44.4 H-ARQ Control IE

The format of H-ARQ_Control_IE, which includes encoding/decoding information for H-ARQ enabled DL/UL bursts, is presented in Table 7. This IE shall be located after CID in the DL/UL_MAP_IE.

Table 7 H-ARQ Control IE format

<u>Syntax</u>	<u>Size</u>	<u>Notes</u>
<u>H-ARQ_Control_IE () {</u>	-	<u>In DL/UL-MAP</u>
<u>Prefix</u>	<u>1 bit</u>	<u>0 = Temporary disable H-ARQ</u> <u>1 = enable H-ARQ</u>
<u>if (Prefix == 1) {</u>		
<u>AI_SN</u>	<u>1 bits</u>	<u>H-ARQ ID Seq. No</u>
<u>SPID</u>	<u>2 bits</u>	<u>Subpacket ID</u>
<u>ACID</u>	<u>4 bits</u>	<u>H-ARQ CH ID</u>
<u>} else {</u>		
<u>Reserved</u>	<u>3 bit</u>	
<u>}</u>		
<u>}</u>		

Prefix

Indicates whether H-ARQ is enabled or not.

AI_SN

Defines ARQ Identifier Sequence Number. This is toggled between '0' and '1' on successfully transmitting each encoder packet with the same ARQ channel.

SPID

Defines SubPacket ID, which is used to identify the four subpackets generated from an encoder packet.

ACID

Defines H-ARQ Channel ID, which is used to identify H-ARQ channels. Each connection can have multiple H-ARQ channels, each of which may have an encoder packet transaction pending.

6.3.2.3.44.5 CQICH Control IE

Table 8 Format of CQICH Control IE

<u>Syntax</u>	<u>Size</u>	<u>Notes</u>
<u>CQICH_Control_IE () {</u>		
<u>CQICH indicator</u>	<u>1 bit</u>	<u>If the indicator is set to 1, the CQICH Control IE follows.</u>
<u>if CQICH indicator == 1 {</u>		

<u>Allocation Index</u>	<u>6 bits</u>	<u>Index to the channel in a frame the CQI report should be transmitted by the SS.</u>
<u>Period (=p)</u>	<u>2 bits</u>	<u>A CQI feedback is transmitted on the CQI channels indexed by the (CQI Channel Index) by the SS in every 2^p frames.</u>
<u>Frame offset</u>	<u>3 bits</u>	<u>The MSS starts reporting at the frame of which the number has the same 3 LSB as the specified frame offset. If the current frame is specified, the MSS should start reporting in 8 frames</u>
<u>Duration (=d)</u>	<u>4 bits</u>	<u>A CQI feedback is transmitted on the CQI channels indexed by the (CQI Channel Index) by the SS for 2^{d-1} frames. If d is 0000, the CQICH is de-allocated. If d is 1111, the MSS should report until the BS command for the MSS to stop.</u>
<u>} else {</u>		
<u>Reserved</u>	<u>3 bits</u>	
<u>}</u>		
<u>}</u>		

Each field of the IE represents the following parameters:

Allocation Index

It indicates its position from the start of the CQICH region

Period

It informs the SS of the period of CQI reports

Frame offset

It informs the SS of when to start. The SS starts reporting at the frame of which the number has the same 3 LSB as the specified frame offset. If the current frame is specified, the SS should start reporting in 8 frames

Duration

It indicates when the SS should stop reporting unless the CQICH allocation is refreshed beforehand. If duration $d == 0000$, the BS is intended to de-allocate the CQICH. If $d == 1111$, the CQICH is allocated indefinitely and the SS should report until the BS commands the SS to stop, which happens it receives another MAP_IE with $d = 0000$.

6.3.2.3.44.6 Compact DL-MAP IE

6.3.2.3.44.6.1 Compact DL-MAP IE for Normal Subchannel

Table 9 Compact_DL-MAP_IE for normal subchannel

Syntax	Size	Notes
Compact_DL-MAP_IE () {		
DL-MAP Type =0	3 bits	
UL-MAP append	1 bits	
RCID_IE	variable	See Reduced CID section
Nep code	4 bits	Code of encoder packet bits (see FEC & CTC section)
Nsch code	4 bits	Code of allocated subchannels (see FEC & CTC section)
H-ARQ_Control_IE	variable	See H-ARQ section
CQICH_Control_IE	variable	See CQICH section

if(UL-MAP append){		
Nep code for UL	4 bits	# of encoder packet bits
Nsch code for UL	4 bits	
H-ARQ_Control_IE for UL	variable	
}		
}		

DL-MAP Type

This value specifies the type of the compact DL-MAP IE. A value of 0 indicates the Normal Subchannel.

UL-MAP append

A value of 1 indicates the uplink access information is appended to the end of the DL-MAP IE.

RCID_IE

Represent the assignment of the IE.

Nep code, Nsch code

The combination of Nep code and Nsch code indicates the number of allocated subchannels and scheme of coding and modulation for the DL burst.

Nep code for UL, Nsch code for UL

The combination of Nep code and Nsch code indicates the number of allocated subchannels and scheme of coding and modulation for the UL burst.

6.3.2.3.44.6.2 Compact DL-MAP IE for Band AMC Subchannel**Table 10 Compact DL-MAP IE for band AMC**

Syntax	Size	Notes
Compact_DL-MAP_IE () {		
DL-MAP Type =1	3 bits	
Reserved	1 bit	
RCID_IE	variable	
Nep code	4 bits	Code of encoder packet bits (see FEC & CTC section)
Nsch code	4 bits	Code of allocated subchannels (see FEC & CTC section)
Nband	Nb-Band bits	Number of bands, 0 = use BITMAP instead
if(Nband == 0){		
Band BITMAP	Nb-BITMAP bits	n-th LSB is 1 if n-th band is selected
}else {		
for (i=0;i< Nband ; i++)		
Band Index	Nb-Index bits	Band selection.
}		
Allocation Mode	4 bit	Indicates the subchannel allocation mode. 00 = same number of subchannels for the selected bands 01 = different number of subchannels for the selected bands 10 = total number of subchannels for the selected bands determined by Nsch code and Nep code 11 = reserved
if(Allocation Mode == 00){		
No. Subchannels	8 bits	
} else if(Allocation Mode == 01){		
for (i=0;i< band count ;i++){		
No. Subchannels	4 bits	If Nband is 0, band count is the number of '1' in Band BITMAP. Otherwise band count is Nband. Number of subchannels per band

<u> </u>		-
<u> </u>		
<u>H-ARO_Control_IE</u>	<u>variable</u>	
<u>COICH_Control_IE</u>	<u>variable</u>	
<u> </u>		
<u> </u>		

DL-MAP Type

This value specifies the type of the compact DL-MAP IE. A value of 1 indicates the Band AMC Subchannel.

RCID IE

Represent the assignment of the IE.

Nep code, Nsch code

The combination of Nep code and Nsch code indicates the number of allocated subchannels and scheme of coding and modulation for the DL burst.

Nband

Indicates the number of bands selected for the burst. If this value is set to 0, the Band BITMAP is used to indicate the number and the position of selected bands instead. The number of the maximum logical bands determines the length of this field.

Band BITMAP

This BITMAP is valid when Nband is 0. The n-th LSB of the Band BITMAP is set to 1 when the n-th logical band is selected for the burst. If the number of the maximum logical bands is 12 then the length of the Band BITMAP is 12 bits. The band count is set to the number of '1's in the Band BITMAP. The number of the maximum logical bands determines the length of this field.

Band Index

This value indexes the selected band offset and is valid when Nband is larger than 0. The number of the maximum logical bands determines the length of this field.

Allocation Mode

This value indicates the subchannel allocation mode in the selected bands.

The value is set to binary 00 when the same numbers of subchannels are allocated in the selected bands by the following field 'No. Subchannels'.

The value is set to 01 when different numbers of subchannels are allocated in each selected bands by the following fields "No. Subchannels".

The value is set to 10 when the total number of subchannels allocated in the selected bands is defined by Nsch code and Nep code. The subchannels fill from the bands with lowest index.

The allocation mode variant is shown in Figure 2.

No. Subchannels

This value indicates the number of subchannels allocated for this burst.

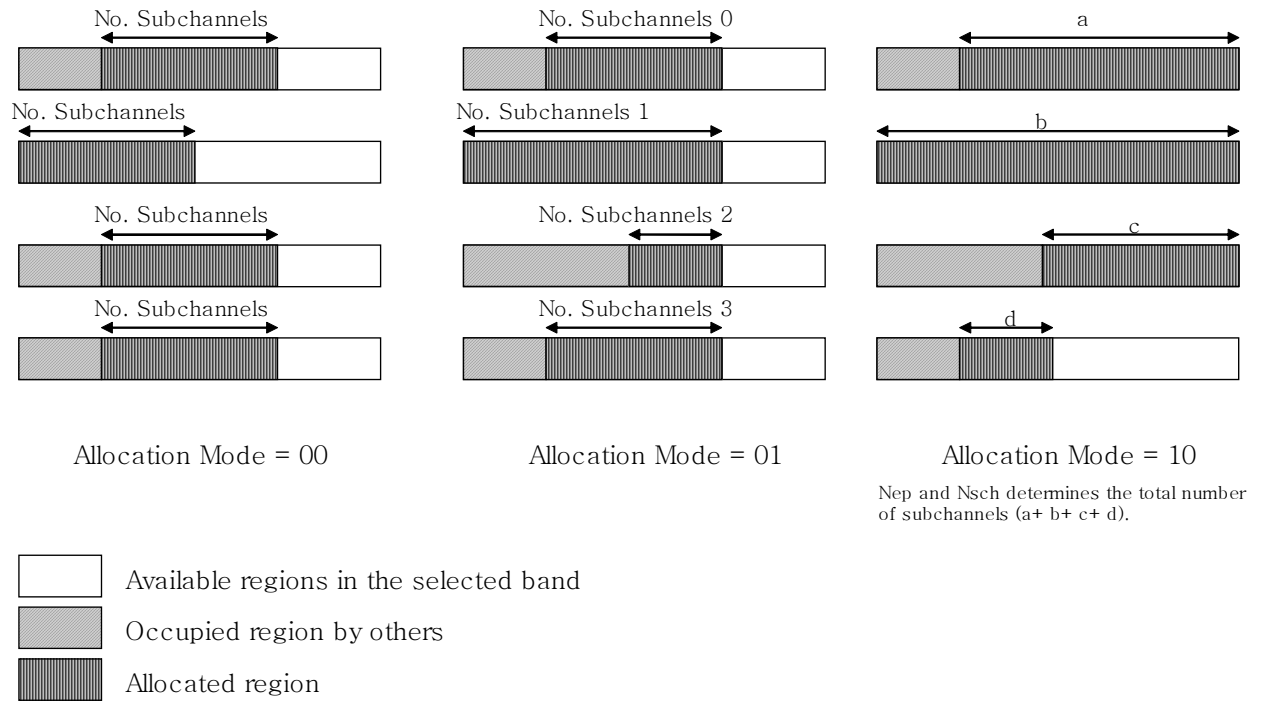

[Figure 2 Subchannel allocation modes of Compact DL-MAP_IE for Band AMC](#)

[6.3.2.3.44.6.3 Compact DL-MAP IE for Safety Subchannel](#)

[Table 11 Compact DL-MAP IE for safety](#)

Syntax	Size	Notes
Compact_DL-MAP_IE () {		
DL-MAP Type =2	3 bits	
UL-MAP append	1 bit	
RCID IE	variable	
Nep code	4 bits	Code of encoder packet bits (see FEC & CTC section)
Nsch code	4 bits	Code of allocated subchannels (see FEC & CTC section)
BIN Offset	8 bits	
H-ARQ Control IE	variable	
CQICH Control IE	variable	
if (UL-MAP append) {		
Nep code for UL	4 bits	Code of encoder packet bits (see FEC & CTC section)
Nsch code for UL	4 bits	Code of allocated subchannels (see FEC & CTC section)
BIN Offset for UL	8 bits	

H-ARQ_Control_IE for UL	variable	
}		
}		

DL-MAP Type

[This value specifies the type of the compact DL-MAP IE.](#)

[A value of 2 indicates the Safety Subchannel.](#)

UL-MAP append

[A value of 1 indicates the uplink access information is appended to the end of the DL-MAP IE.](#)

RCID IE

[Represent the assignment of the IE.](#)

Nep code, Nsch code

[The combination of Nep code and Nsch code indicates the number of allocated subchannels and scheme of coding and modulation for the burst.](#)

BIN Offset

[The offset of the BIN allocated for this DL burst. See appropriate specification.](#)

Nep code for UL, Nsch code for UL

[The combination of Nep code and Nsch code indicates the number of allocated subchannels and scheme of coding and modulation for the UL burst.](#)

BIN Offset for UL

[The offset of the BIN allocated for this UL burst. See appropriate specification.](#)

6.3.2.3.44.6.4 Compact DL-MAP IE for DIUC Subchannel**Table 12 Compact DL-MAP IE for DIUC**

<u>Syntax</u>	<u>Size</u>	<u>Notes</u>
Compact_DL-MAP_IE () {		
DL-MAP Type = 3	3 bits	DIUC type
Reserved	1 bits	
DIUC	4 bits	See DIUC section
RCID IE	variable	
No. Subchannels	8 bits	The number of subchannels allocated by the IE
}		

DL-MAP Type

[This value specifies the type of the compact DL-MAP IE. A value of 3 indicates the DIUC type.](#)

DIUC

[This value indicates the usage of this burst.](#)

RCID IE

[Represent the assignment of the IE.](#)

No. Subchannels

[This value indicates the number of subchannels allocated by the IE.](#)

6.3.2.3.44.6.5 Compact DL-MAP IE for H-ARQ ACK BITMAP

[The H-ARQ ACK Bitmap information for the H-ARQ enabled UL bursts is delivered through the Compact DL-MAP IE as shown in Table 13. The bit position in the bitmap is determined by the order of the H-ARQ enabled UL bursts in the UL-MAP. The frame offset between the UL burst and the H-ARQ-ACK-BITMAP is specified by "H-ARQ ACK Delay for UL Burst" field in the DCD message.](#)

[For example, when a SS transmits a H-ARQ enabled burst at i-th frame and the burst is j-th H-ARQ enabled burst in the MAP, the SS should receive H-ARQ ACK at j-th bit of the BITMAP which is sent by the BS at i+\(frame offset\)-th frame.](#)

Table 13 Compact DL-MAP IE for H-ARQ ACK BITMAP

Syntax	Size	Notes
Compact DL-MAP IE () {		
DL-MAP Type = 5	3 bits	H-ARQ ACK BITMAP IE
Reserved	1 bit	
BITMAP Length	4 bits	Length in Bytes
BITMAP	variable	
}		

DL-MAP Type

Defines the type of Compact DL-MAP. If the type value is 5, the Compact DL-MAP is for H-ARQ-ACK-BITMAP.

BITMAP Length

Specifies the length of the following BITMAP field.

BITMAP

Includes H-ARQ ACK information for H-ARQ enabled UL bursts. The size of BITMAP should be equal or larger than the number of H-ARQ enabled UL-bursts.

6.3.2.3.44.6.6 Compact DL-MAP IE for Extension**Table 14 Compact DL-MAP IE for extension**

Syntax	Size	Notes
Compact DL-MAP IE () {		
DL-MAP Type = 7	3 bits	Extension type
DL-MAP Sub-Type	5 bits	Extension sub type
Length	4 bits	Length of the IE in Bytes
Payload	variable	Sub-type dependent payload
}		
Total		

DL-MAP Type

This value specifies the type of the compact DL-MAP IE. A value of 7 indicates the extension type.

DL-MAP Sub-Type

This value specifies the sub-type of the compact DL-MAP IE.

Length

This indicates the length of this IE in Bytes. If a SS can't recognize the DL-MAP Sub-Type, it skips the IE.

Payload

The payload depends on the value of DL-MAP Sub-Type. The length of payload is Length -1 Bytes.

6.3.2.3.44.7 UL-MAP IE**6.3.2.3.44.7.1 Compact UL-MAP IE for Normal Subchannel****Table 15 Compact UL-MAP IE for normal subchannel**

Syntax	Size	Notes

<u>Compact_UL-MAP_IE () {</u>		
<u>UL-MAP Type = 0</u>	<u>3 bits</u>	
<u>Reserved</u>	<u>1 bit</u>	
<u>RCID_IE</u>	<u>variable</u>	
<u>Nep code</u>	<u>4 bits</u>	<u>Number of encapsulate packet</u>
<u>Nsch code.</u>	<u>4 bits</u>	-
<u>H-ARQ_Control_IE</u>		
<u>}</u>		

6.3.2.3.44.7.2 Compact UL-MAP IE for Band AMC Subchannel

Table 16 Compact UL-MAP IE for band AMC

<u>Syntax</u>	<u>Size</u>	<u>Notes</u>
<u>Compact_UL-MAP_IE () {</u>		
<u>UL-MAP Type = band</u>	<u>3 bits</u>	
<u>Reserved</u>	<u>1 bit</u>	
<u>RCID_IE</u>	<u>variable</u>	
<u>Nep code</u>	<u>4 bits</u>	<u>Number of encapsulate packet</u>
<u>Nsch code</u>	<u>4 bits</u>	
<u>Nband</u>	<u>Nb-Band bits</u>	<u>Indicates the number of selected bands. 0 = BITMAP indicates the number and offset of selected bands</u>
<u>if(Nband == 0){</u>		
<u> Band BITMAP</u>	<u>Nb-BITMAP bits</u>	<u>n-th LSB is 1 if n-th band is selected</u>
<u> }else {</u>	-	-
<u> for (i=0;i<Nband;i++){</u>		
<u> Band Index</u>	<u>Nb-Index bits</u>	<u>Band selection.</u>
<u> }</u>		
<u> Allocation Mode</u>	<u>2 bit</u>	<u>Indicates the subchannel allocation mode. 00 = same No. subchannel for the selected bands 01 = different No. subchannel for the selected bands 10 = total No. subchannels for the selected bands determined by Nsch code</u>
<u> if(Allocation Mode == 0){</u>		
<u> No. Subchannels</u>	<u>6 bits</u>	
<u> } else if(Allocation Mode == 1){</u>		
<u> for (i=0;i< band count ;i++){</u>		<u>If Nband is 0, band count is the number of '1' in Band BITMAP. Otherwise band count is Nband.</u>
<u> No. Subchannels</u>	<u>6 bits</u>	<u>Number of subchannels per band</u>
<u> }</u>	-	-
<u> }</u>		
<u>H-ARQ_Control_IE</u>	<u>variable</u>	
<u>}</u>		

6.3.2.3.44.7.3 Compact UL-MAP IE for Safety Subchannel

Table 17 Compact UL-MAP IE for safety

Syntax	Size	Notes
<u>Compact_UL-MAP_IE () {</u>		
<u>UL-MAP Type = 2</u>	<u>3 bits</u>	
<u>Reserved</u>	<u>1 bit</u>	
<u>RCID_IE</u>	<u>variable</u>	
<u>Nep code</u>	<u>4 bits</u>	<u>Number of encapsulate packet</u>
<u>Nsch code</u>		
<u>BIN Offset</u>	<u>8 bits</u>	
<u>H-ARQ_Control_IE</u>	<u>variable</u>	
<u>}</u>		

6.3.2.3.44.7.4 Compact UL-MAP IE for UIUC Subchannel

Table 18. Compact UL-MAP IE for UIUC

Syntax	Size	Notes
<u>Compact_UL-MAP_IE () {</u>		
<u>UL-MAP Type = 4</u>	<u>3 bits</u>	
<u>Reserved</u>	<u>1 bits</u>	
<u>UIUC</u>	<u>4 bits</u>	
<u>RCID_IE</u>	<u>variable</u>	
<u>No. Subchannels</u>	<u>8 bits</u>	
<u>}</u>		

6.3.2.3.44.7.5 Compact UL-MAP IE for H-ARQ Region Allocation

The H-ARQ ACK region information is delivered through the Compact UL-MAP IE as shown in Table 19. SS sends ACK information for H-ARQ enabled DL bursts in the H-ARQ region specified by the IE.

Table 19 Compact UL-MAP IE for H-ARQ Region

Syntax	Size	Notes
<u>Compact_UL-MAP_IE () {</u>		
<u>UL-MAP Type = 4</u>	<u>3 bits</u>	<u>H-ARQ_Region_IE</u>
<u>H-ARQ_Region_Change_Indication</u>	<u>1 bit</u>	<u>0: no region change</u> <u>1: region changed</u>
<u>if(H-ARQ_Region_Change_Indication == 1) {</u>		
<u> <u>OFDMA_Symbol_offset</u></u>	<u>8 bits</u>	
<u> <u>Subchannel_offset</u></u>	<u>8 bits</u>	
<u> <u>No. OFDMA_Symbols</u></u>	<u>8 bits</u>	
<u> <u>No. Subchannels</u></u>	<u>8 bits</u>	
<u>}</u>		
<u>}</u>		

H-ARQ Region Change Indication

Indicates whether the region for H-ARQ ACK is changed or not.

OFDMA Symbol offset**Subchannel offset****No. OFDMA Symbols****No. Subchannels**

Specify the start symbol offset, the start subchannel offset, the number of allocated symbols and the number of subchannels for the H-ARQ acknowledgement region respectively.

6.3.2.3.44.7.6 Compact UL-MAP IE for CQICH Region Allocation

The CQI region information is delivered through the Compact_UL-MAP_IE as shown in Table 20. SS sends CQI report in CQI region.

Table 20 Compact UL-MAP IE for CQI Region

<u>Syntax</u>	<u>Size</u>	<u>Notes</u>
<u>Compact_UL-MAP_IE () {</u>		
<u>UL-MAP Type = 5</u>	<u>3 bits</u>	<u>CQI_Region_IE</u>
<u>CQI Region Change Indication</u>	<u>1 bits</u>	<u>0: no region change</u> <u>1: region changed</u>
<u>if(CQI Region Change Indication == 1) {</u>		
<u> OFDMA Symbol offset</u>	<u>8 bits</u>	
<u> Subchannel offset</u>	<u>8 bits</u>	
<u> No. OFDMA Symbols</u>	<u>8 bits</u>	
<u> No. Subchannels</u>	<u>8 bits</u>	
<u>}</u>		
<u>}</u>		

CQI Region Change Indication

Indicates whether the region for CQI is changed or not.

OFDMA Symbol offset**Subchannel offset****No. OFDMA Symbols****No. Subchannels**

Specify the start symbol offset, the start subchannel offset, the number of allocated symbols and the number of subchannels for the CQI report region respectively.

6.3.2.3.44.7.6 Compact UL-MAP IE for Extension

Table 21 Compact_UL-MAP_IE for extension

<u>Syntax</u>	<u>Size</u>	<u>Notes</u>
<u>Compact_UL-MAP_IE () {</u>		
<u>UL-MAP Type = 7</u>	<u>3 bits</u>	
<u>UL-MAP Sub-Type</u>	<u>5 bits</u>	
<u>Length</u>	<u>4 bits</u>	<u>Length of this IE in Bytes</u>
<u>Payload</u>		<u>Sub-type dependent payload</u>

2004-04-21

IEEE C802.16.d-04_74r1

--	--	--

Add the following rows to table 365:

<u>Name</u>	<u>Type</u>	<u>Length</u>	<u>Value</u>
Band AMC Allocation Threshold	157	1	dB unit
Band AMC Release Threshold	158	1	dB unit
Band AMC Allocation Timer	159	1	Frame unit
Band AMC Release Timer	160	1	Frame unit
Band Status Reporting MAX Period	161	1	Frame unit
Band AMC Retry Timer	162	1	Frame unit
Safety Channel Allocation Threshold	163	1	dB unit
Safety Channel Release Threshold	164	1	dB unit
Safety Channel Allocation Timer	165	1	Frame unit
Safety Channel Release Timer	166	1	Frame unit
Bin Status Reporting MAX Period	167	1	Frame unit
Safety Channel Retry Timer	168	1	Frame unit
H-ARQ ACK delay for UL burst	169	1	1 = 1 frame offset 2 = 2 frame offset 3 = 3 frame offset

Add the following rows to table 374:

<u>Name</u>	<u>Type</u>	<u>Length</u>	<u>Value</u>
H-ARQ ACK delay for DL burst	154	1	1 = 1 frame offset 2 = 2 frame offset 3 = 3 frame offset

[Change the table in section 11.8.3.7.2 and 11.8.3.7.3]

11.8.3.7.2 OFDMA SS demodulator

<u>Type</u>	<u>Length</u>	<u>Value</u>	<u>Scope</u>
5.12.2	1	bit #0: 64-QAM bit #1: BTC	SBC-REQ (see 6.4.2.3.23)

		bit #2: CTC bit #3: STC bit #4: AAS bit #5-7: Reserved bit #5: H-ARQ bit #6-7: Reserved, shall be set to 0	SBC-RSP (see 6.4.2.3.24)
--	--	---	-----------------------------

11.8.3.7.3 OFDMA SS modulator

Type	Length	Value	Scope
5.12.2	1	bit #0: 64-QAM bit #1: BTC bit #2: CTC bit #3-7: Reserved, set to 0 bit #3: H-ARQ bit #4-7: Reserved, shall be set to 0	SBC-REQ (see 6.4.2.3.23) SBC-RSP (see 6.4.2.3.24)

11.8.3.7.4 OFDMA SS modulator

Type	Length	Value	Scope
5.12.3	1	The number of HARQ ACK Channel	SBC-REQ (see 6.4.2.3.23) SBC-RSP (see 6.4.2.3.24)

[Change the table in section 11.11 and 11.12]

11.11 TLV of REP-REQ
 Add the following parameters:

Name	Type	Length	Value
Channel Type request	2.1	1	00 = Normal subchannel, 01 = Band AMC Channel, 10 = Safety Channel, 11 = Reserved for future

11.12 TLV of REP-RSP
 Add the following parameters:

REP-REQ	Name	Type	Length	Value
Channel Type request in WirelessMAN-OFDMA PHY				

	Reported Channel Type	2.1	1	00 = Normal subchannel, 01 = Band AMC Channel, 10 = Safety Channel, 11 = Reserved for future
Channel Type type in WirelessMAN-OFDMA PHY = 00	Normal subchannel Report	2.2	1	First 5 bits for the CINR measurement report and the rest for don't care
Channel Type type in WirelessMAN-OFDMA PHY = 01	Band AMC Report	2.3	4	First 12 bits for the band indicating bitmap and Next 25 bits for CINR reports (5 bits per each band)
Channel Type type in WirelessMAN-OFDMA PHY = 10	Safety Channel Report	2.3	5	The first 20 bits for the reported bin indices and the next 20 bits for CINR reports (5 bits for each bin)