

Advent of 10G Asymmetric EPON

BIN YEONG YOON, ETRI
GABRIEL SHIN, CMB

Contents

- Killer application of FTTH
- Evolution of EPON considering future IPTV services
- Issues on IPTV
- Conclusions

Broadband Subscribers of Korea

- Broadband deployment of 65% penetration
- Optical LAN is on increase
- Cable modem and xDSL are staggering
- There is no room for EPON due to no killer application

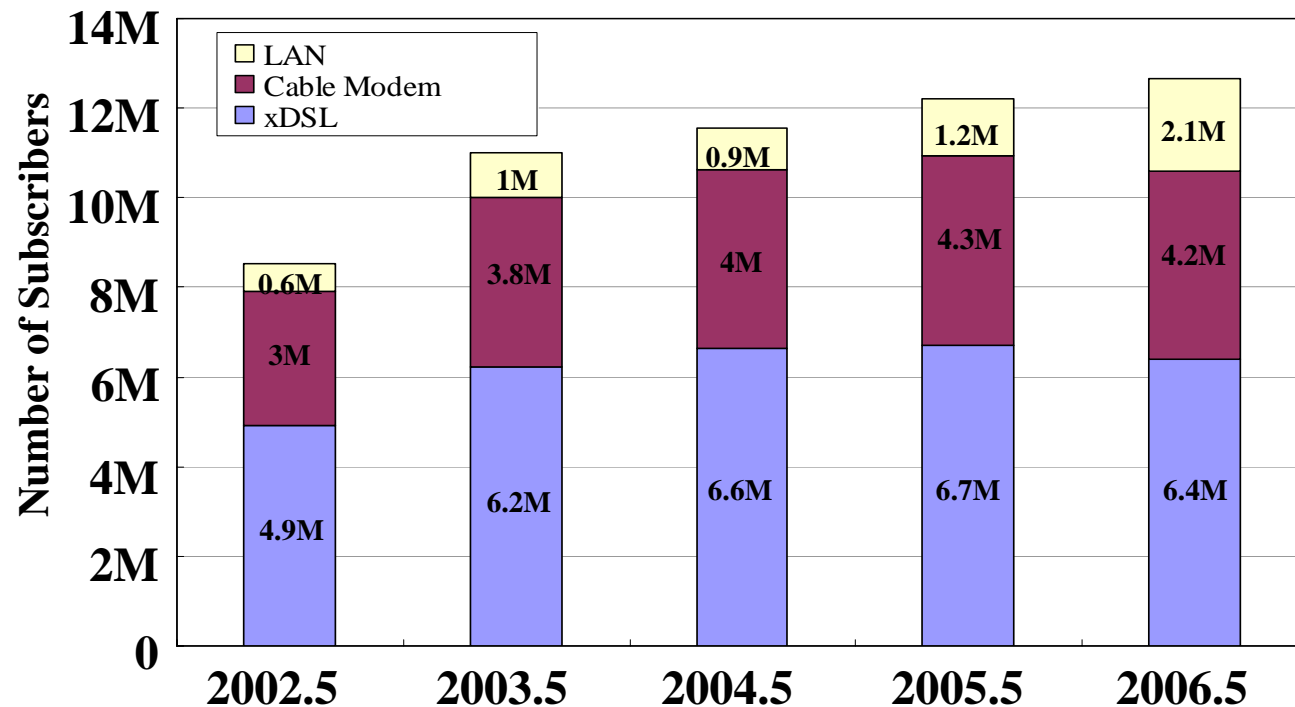

IPTV would be a savior

- Killer application is needed to spur the deployment of EPON
- IPTV can be one of the candidates
 - Delivery of both broadcast and on-demand TV and video services using Internet protocol
 - IPTV services value will be increased sharply

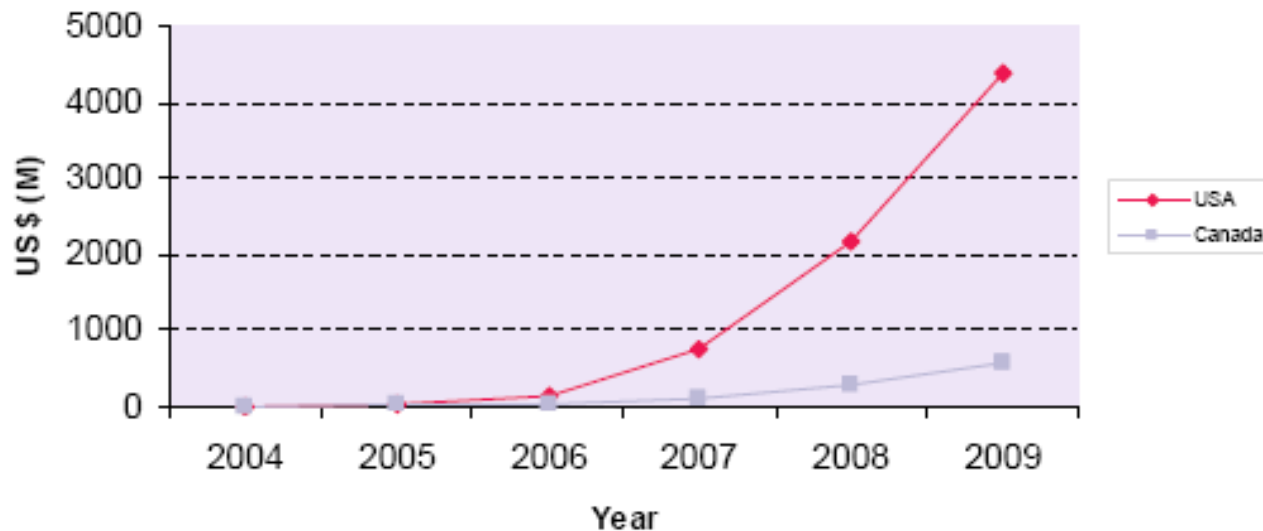

IPTV Revenues in North America (Ovum, 2006)

Multi-vision Service

- Multi-channels popped up on the screen simultaneously like browsers on PC

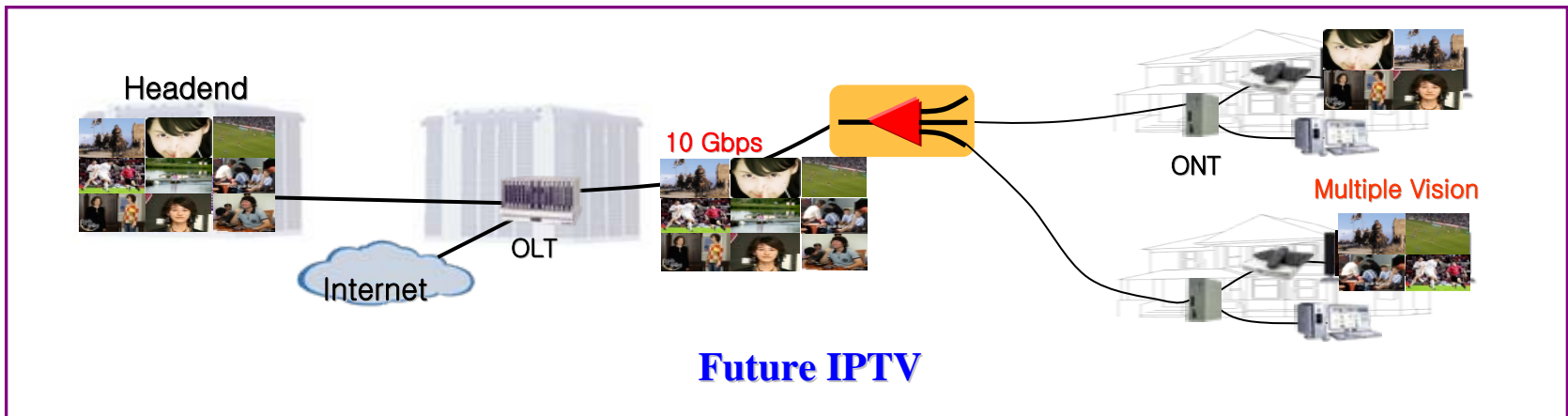
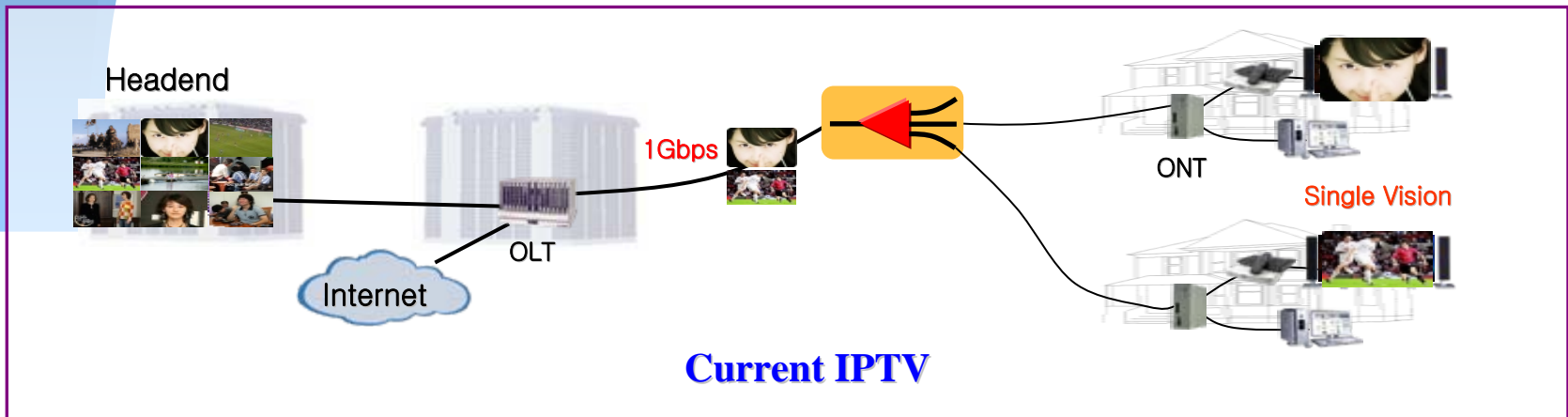

Multi-angle service

- More bandwidth required to provide multi-streams per channel

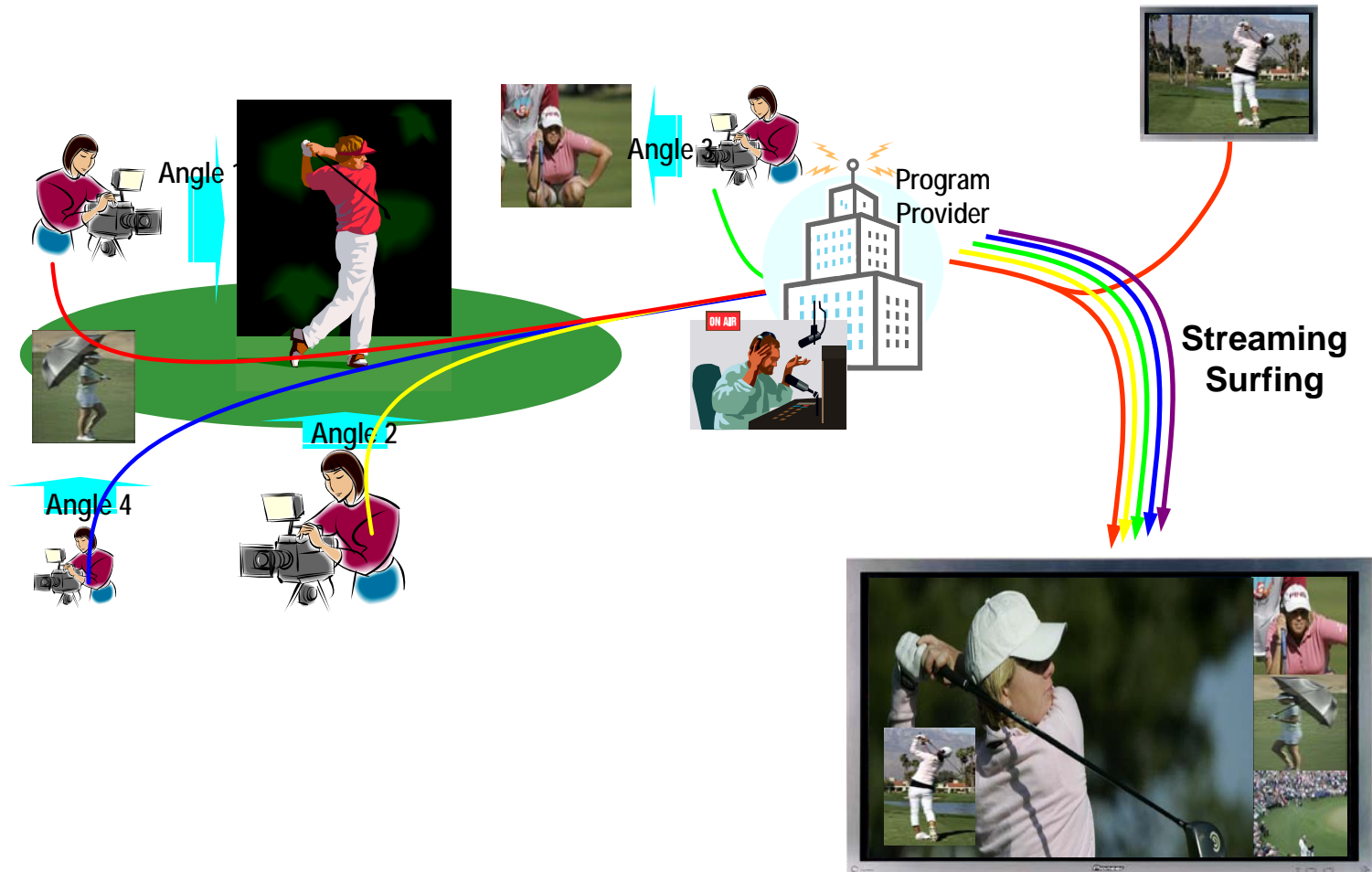

Number of channels increased

Service Offerings

Current Situation

- ✓ Broadcast
- ✓ Video-on-Demand

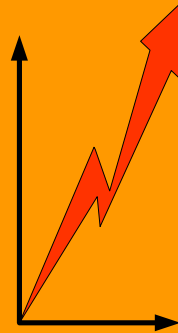

Near Future (2010)

- ✓ Time-shifted / narrowcast
- ✓ All-channel network-based personal video recorder
- ✓ Picture-in-picture / split screen
- ✓ Digital cinema distribution
- ✓ Personal multimedia publishing
- ✓ Residential and business digital video surveillance

Bandwidth Per Channel

Current Situation

- ✓ **Standard Definition TV (SDTV)**
2 Mbps per channel



Near Future (2010)

- ✓ **High Definition TV (HDTV)**
10+ Mbps per channel
- ✓ **Large-Screen Digital Imagery (LSDI)** [standardized by ITU-T J.601]
40 or 160 Mbps per channel

Number of Channels

Current Situation

- ✓ 30 ~ 100 channels



Near Future (2010)

- ✓ 1,000 or more channels

For now, AT&T will offer 200 channels, though it expects to offer 1,000 or more channels when it expands the service to other markets in about six months. Its channel lineup already includes major networks as well as ESPN, HBO, the Discovery Channel, the Disney Channel, MTV, the History Channel, USA, CNN, National Geographic and others.

The Wall Street Journal
January 5, 2006

Evolution of EPON

More Bandwidth will be required for future IPTV services

- Multi-vision service
- Multi-angle service
- Number of channels increased



Evolution of EPON

- Broadcast Bandwidth
- Unicast Bandwidth
- Bandwidth allocation
- Impact on home networks

Evolution of EPON Technology

Step I : 1Gbps/1Gbps(DS/US)

The first commercial FTTH technology with Gigabit bandwidth deployed in the world

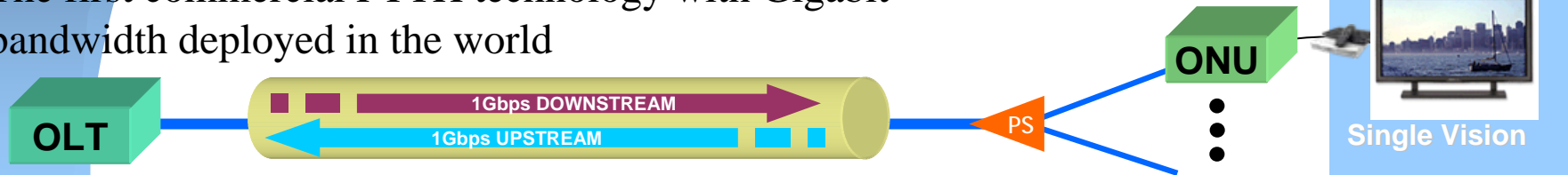

Step II : 10Gbps/1Gbps(DS/US)

Advanced digital TV services & CATV replacement

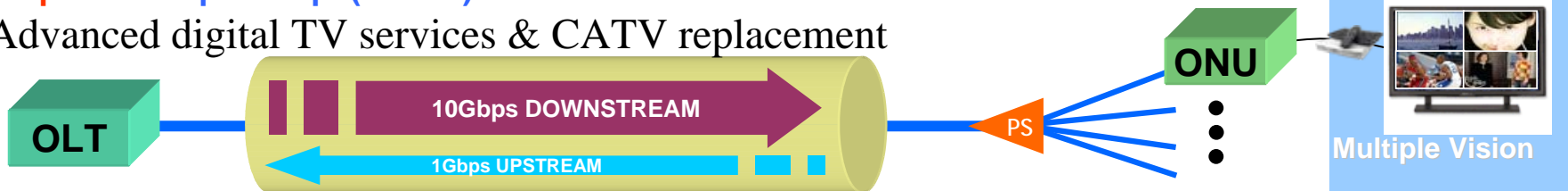

Step III : 10Gbps/10Gbps(DS/US)

Cost effective system by more subscribers & more bandwidth for US

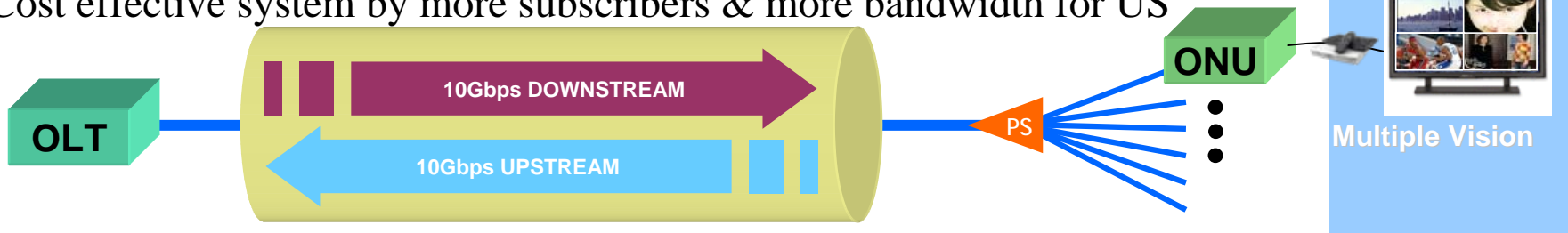

Broadcast Bandwidth

- Theoretically, DS bandwidth up to 5Gbps for broadcast services
- Several hundred Mbps of data services by channel bonding of Data Over Cable Service Interface Specification 3.0 (DOCSIS 3.0)

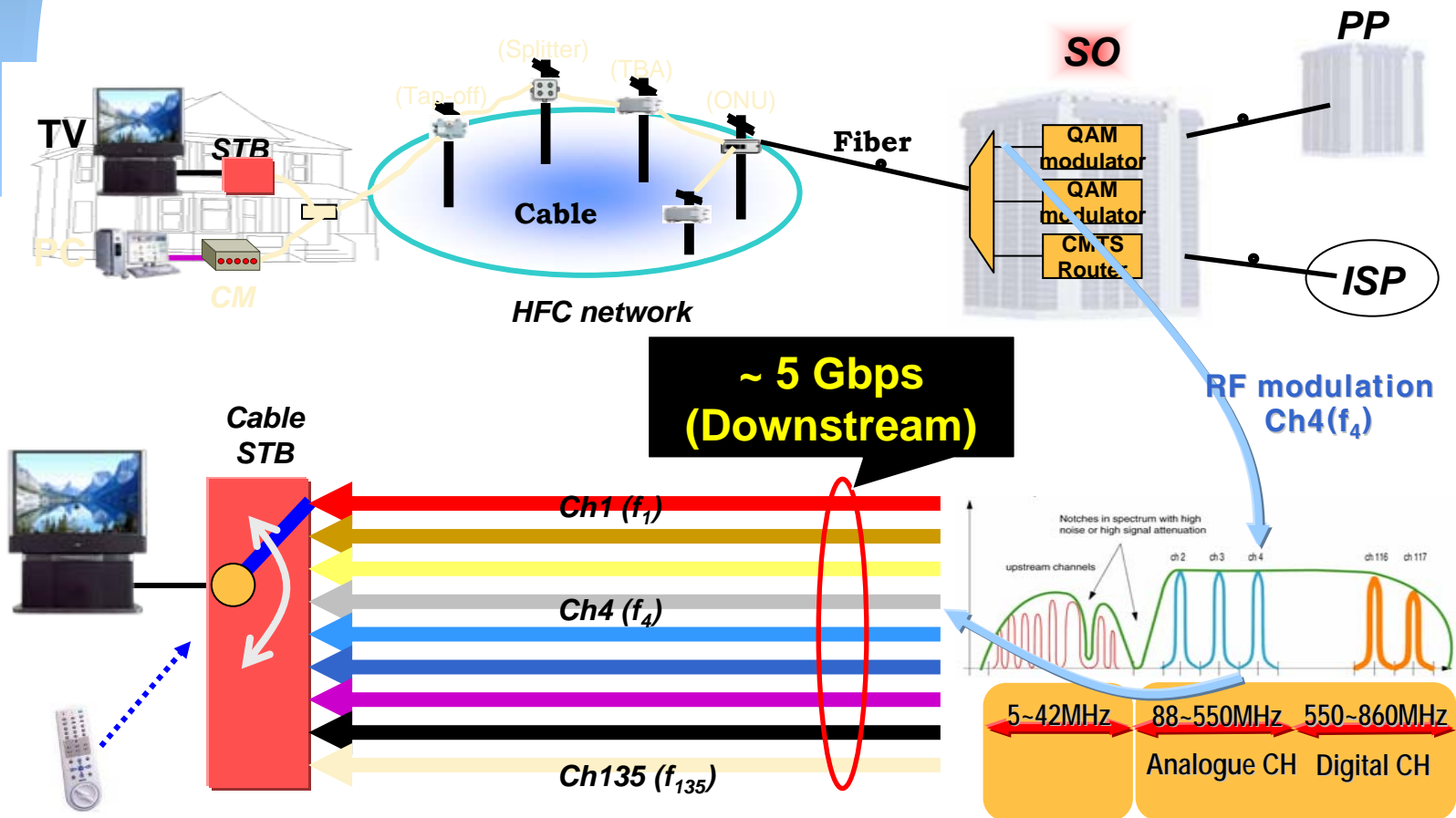

Unicast Bandwidth

- The ratio of downstream to upstream: Symmetry or Asymmetry ?
 - Current State ⇒ **slight asymmetry (~ 2:1)**
 - Peer to peer (P2P) service is dominant
 - Future Trends ⇒ **severe asymmetry**
 - Revenue generating BW is downstream
 - Asymmetrical HFC capacity: ~ 22:1

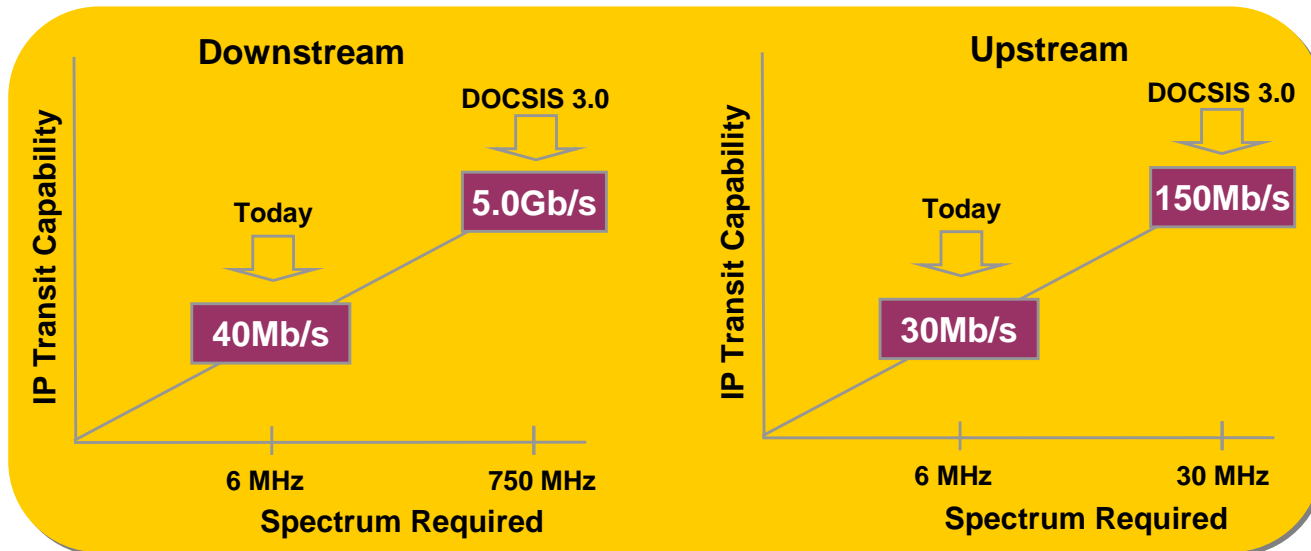
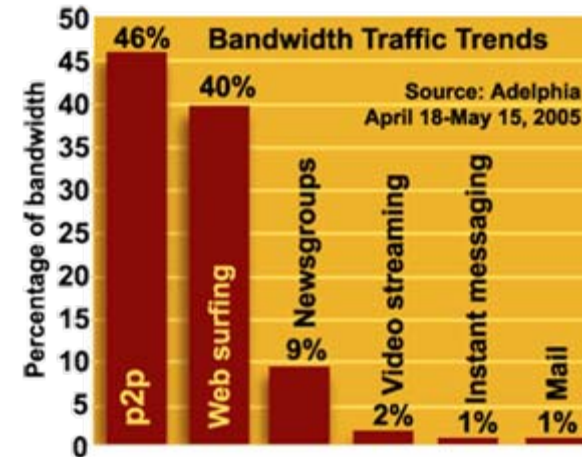

Source: M. Fawaz, CableLabs Media Briefing, 2005

Allocation of Bandwidth for 10G Asymmetric EPON

- **Upstream BW:** Existing services (1.25Gb: Internet, VoIP etc.)
- **Downstream BW:** Existing services(2.5Gb), broadcast(5Gb), Services generating revenues (2.5Gb: video streaming services, etc.)

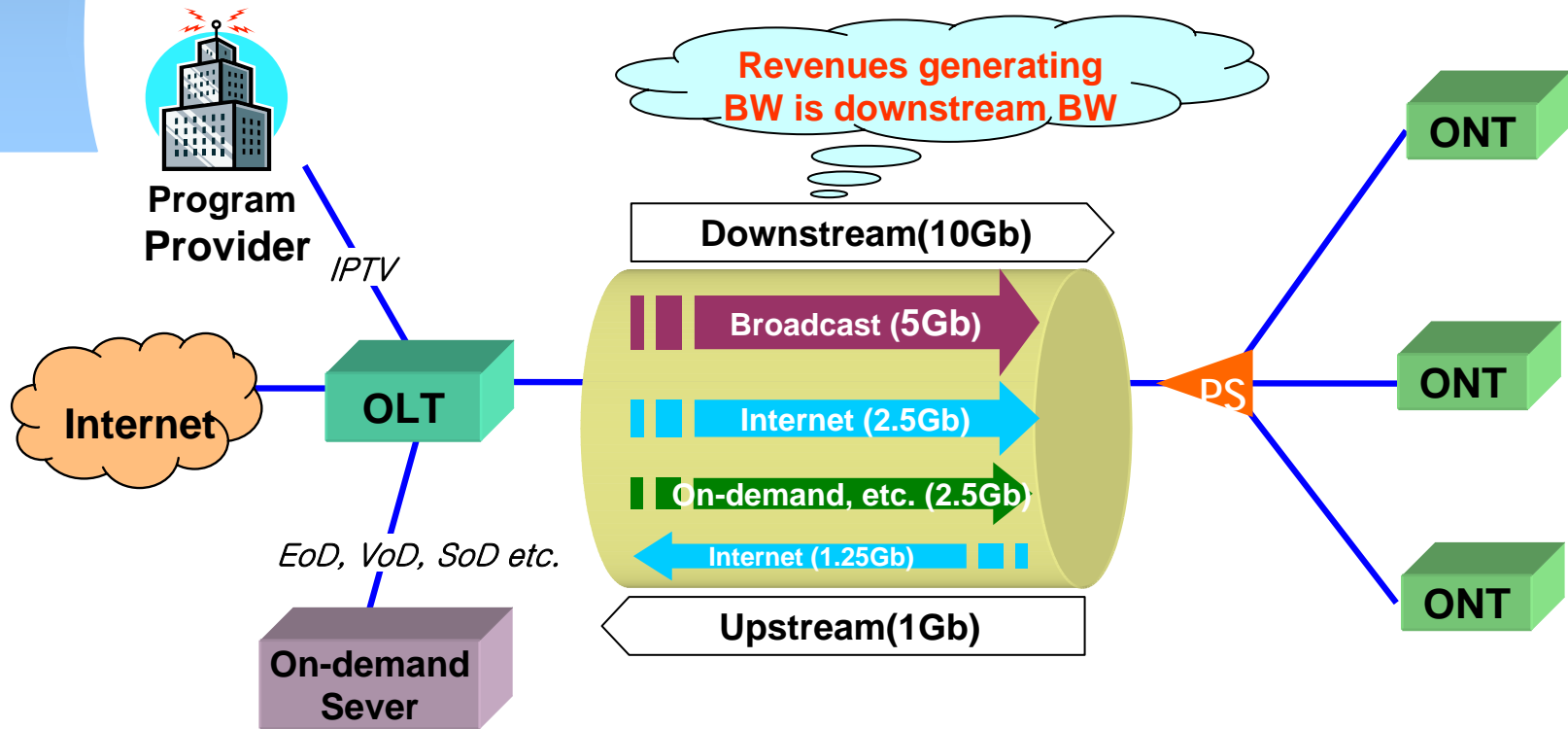

Impact on home networks

- 10G EPON triggering business of new technologies such as AV Bridges (Residential Ethernet) and 10GBASE-T
- Getting rid of coaxial cable for video signal

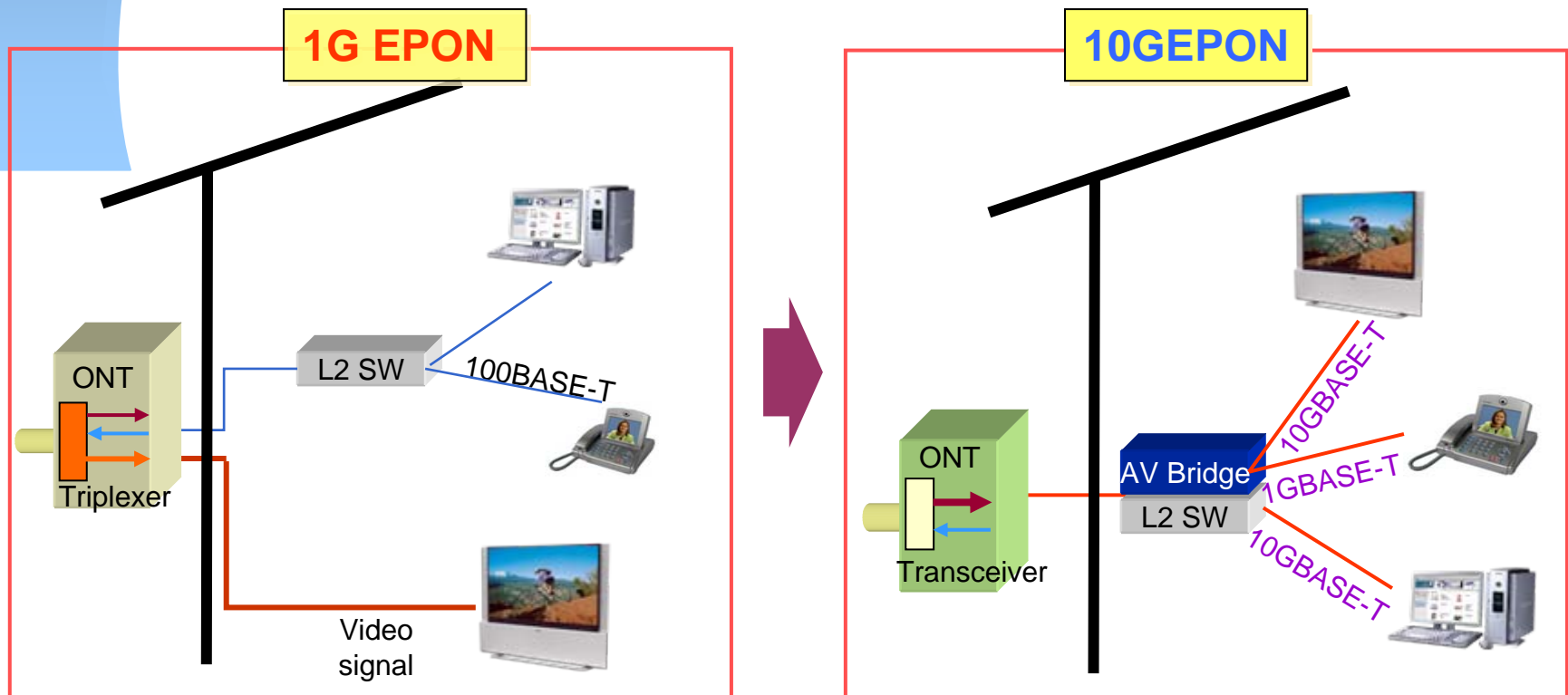

Issues on IPTV Services

Evolution of EPON

- Necessity of 10G asymmetric EPON
- Asymmetric internet traffic
- Bandwidth allocation
- Impact on home networks



Issues on IPTV services

- Channel zapping delay
- Configurations of networks

Channel Zapping Delay

- Channel Zapping Delay is

A matter of how quickly end user can change channels

- Major source of channel zapping delay is *multicast leave & join latency*

- Multicast signaling: IGMP for IPv4 or MLD for IPv6

- IGMP: Internet Group Management Protocol

- MLD: Multicast Listener Discovery

- Channel Zapping Delay

= Selected channel traffic received time [t2]

– IGMP leave message for previous channel transmitted time [t1]

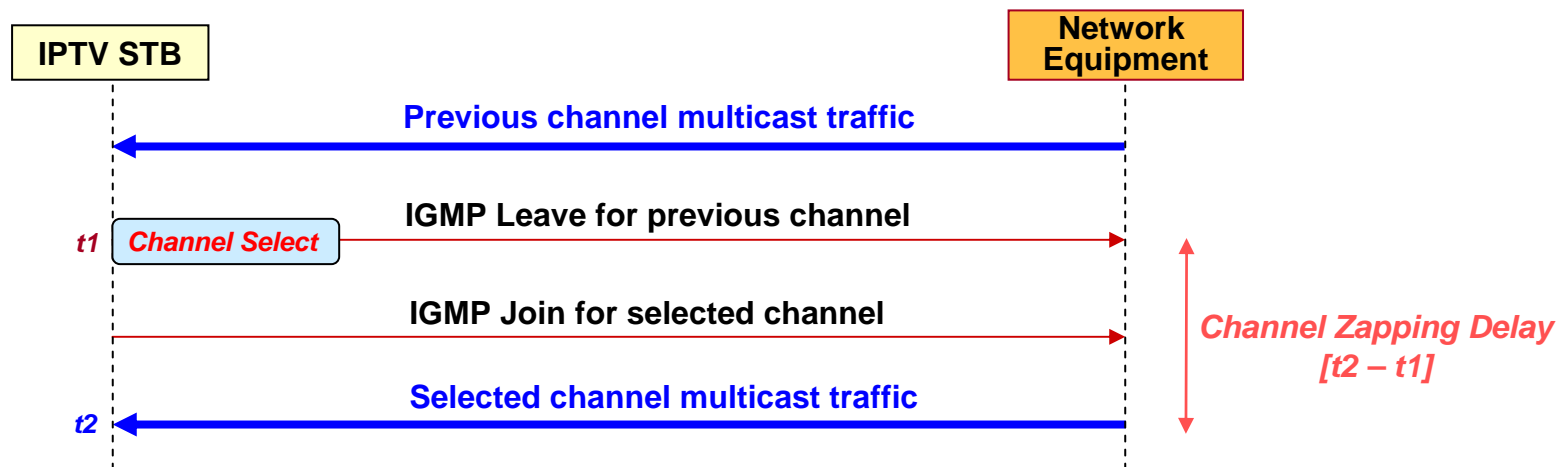

Case Studies of Channel Zapping Delay

- Zapping time between 2 channels at ADSL based IPTV service: 2 ~ 5 s
 - Comparative study of 3 operators in France in July 2004 (Source:<http://www.01net.com/article/248891.html>)

- Test of Channel Zapping time on condition of large subscribers
 - Tested by Agilent Technologies in order to evaluate channel zapping performance when many subscribers zap channels simultaneously
 - Zapping delay is about 0.9 ~ 70 s depending on configurations of subscribers
 - increased number of subscribers dramatically affects the channel zapping delay

(Source: Agilent Technologies “Testing IPTV channel zapping”)

Suppressing Options of Channel Zapping Delay

- To suppress the channel zapping delay for 10G EPON:
 - It is required to reduce the number of subscribers that try to zap the channel at the same time

<p>Option 1 1G EPON with FE port at ONT</p>		<p># of IGMP signals from all users: ~ 5,000</p>
<p>Option 2 10G EPON with GE/FE port at ONT</p>		<p># of IGMP signals from ONT/ONU users: ~ 32</p>
<p>Option 3 10G EPON with 10G port at ONT</p>		<p>No IGMP signals Channel zapping as fast as CATV</p>

STB: Set Top Box, MR: Multicast Router

1G EPON for IPTV

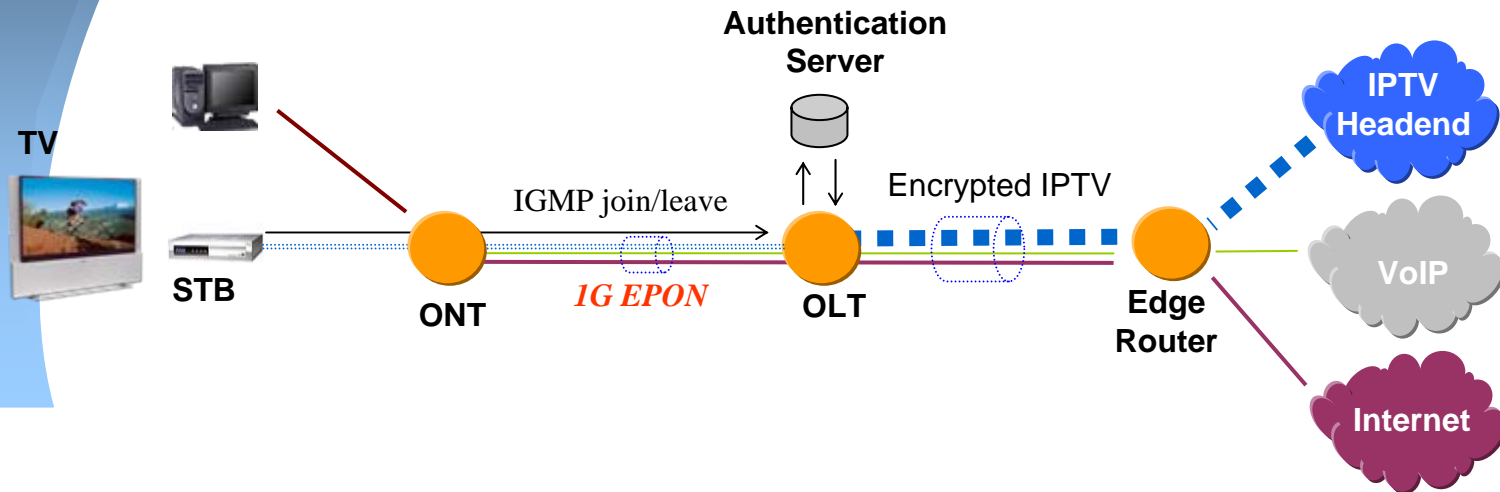

- **Configuration of 1G EPON access network for IPTV**
 - **Complex networks**
 - **Complex traffic management of individual IPTV channels**
 - **IGMP needed**
 - **Authentication against a channel join attack**
 - **High cost of network management**

10G EPON for IPTV

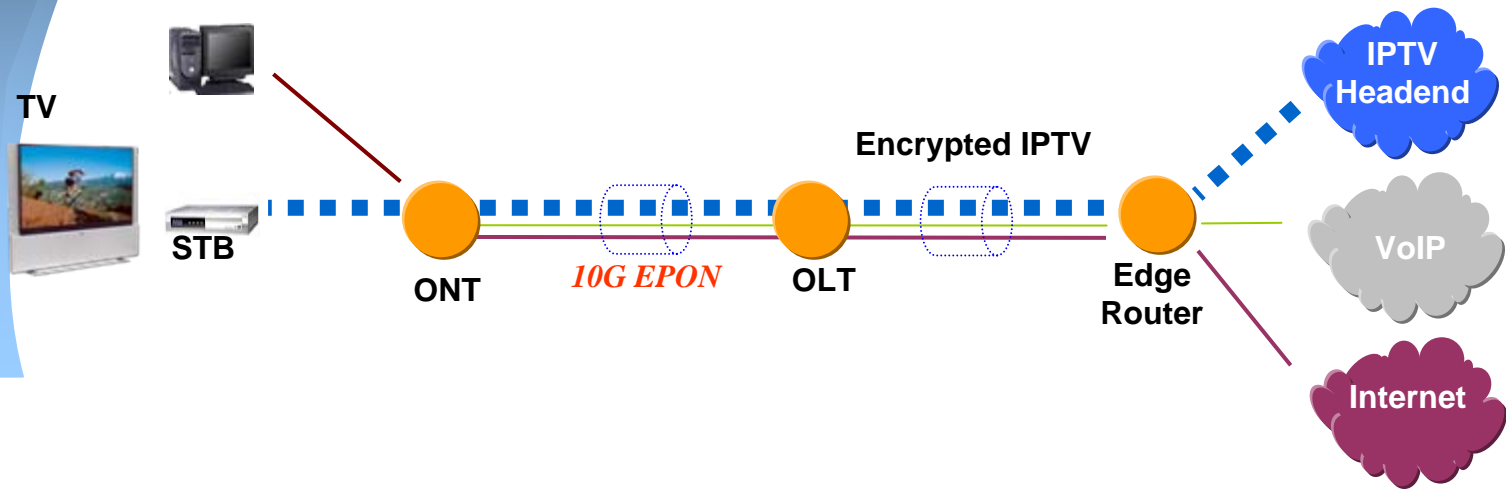

■ Configuration of 10G EPON access network for IPTV

- Simple networks like CATV
- Easy traffic management of just one single virtual path containing all broadcast channels
- No IGMP
- Low cost of network management

Necessity of 10G Asymmetric EPON

- 10G EPON can support TPS better than any other access technologies
 - Reducing channel zapping delay
 - Avoiding complex networks to support QoS of broadcast services
- DS traffic should be increased for future broadcast services
 - Multi-visions, multi-angles, and number of channels increased
 - More than 5Gbps allocated for broadcast to keep the same bandwidth as CATV
- US traffic of customers not allowed to be increased dramatically
 - No high revenue expected from increasing US user traffic
- Reasonable cost
 - Currently, cost of 10G symmetric EPON system is too expensive to be deployed, compared to 10G asymmetric EPON

Conclusions

- IPTV service value will be increased
- 10G asymmetric EPON well suitable for IPTV
 - Huge 10Gbps DS bandwidth
 - Reducing channel zapping delay
 - Simple access networks
- Winner or loser
 - CATV trying to increase Internet bandwidth by DOCSIS 3.0
 - FSAN starting to discuss 10Gbps GPON on Sep.
 - Optical LAN increased with low cost and easy migration
 - xDSL exceeds the average bandwidth of 1Gbps EPON per subscriber