

1.5 μ m DML at 10Gb/s for links of 20km and beyond in SMF-28

IEEE 802.3av Interim Meeting, Monterey, CA

1/15-16/07

Thomas Schrans

Optical Communication Products, Inc.

Acknowledgment

- Work performed at Ortel Corporation (1995-1996): ARPA funded WEST Program (WDM and Electronic Switching Technology)
- Presented at LEOS'96 ThI1 as invited paper
- Other research groups at Alcatel, Deutsche Telekom, Corning have reported similar results

Introduction

- Low cost solution is critical for high volume implementation
- DML is the lowest cost solution in most other applications
- Chirp and dispersion at $1.5\mu\text{m}$ is believed to exclude DML as a solution for downstream 10Gb/s link
- Discussed downstream solutions are:
 - EML: higher cost due to higher laser current, lower output power, need for temperature control
 - EDC: added cost from IC, added power dissipation
- Objective:
 - Demonstrate that 20km 10Gb/s link at $1.5\mu\text{m}$ is possible with a DML without using EDC
 - promote development of PMD that enables the use of $1.5\mu\text{m}$ DML without using EDC for 10Gb/s downstream link

40km and 60km of SMF-28 with 1550nm 10Gb/s DML (cooled)

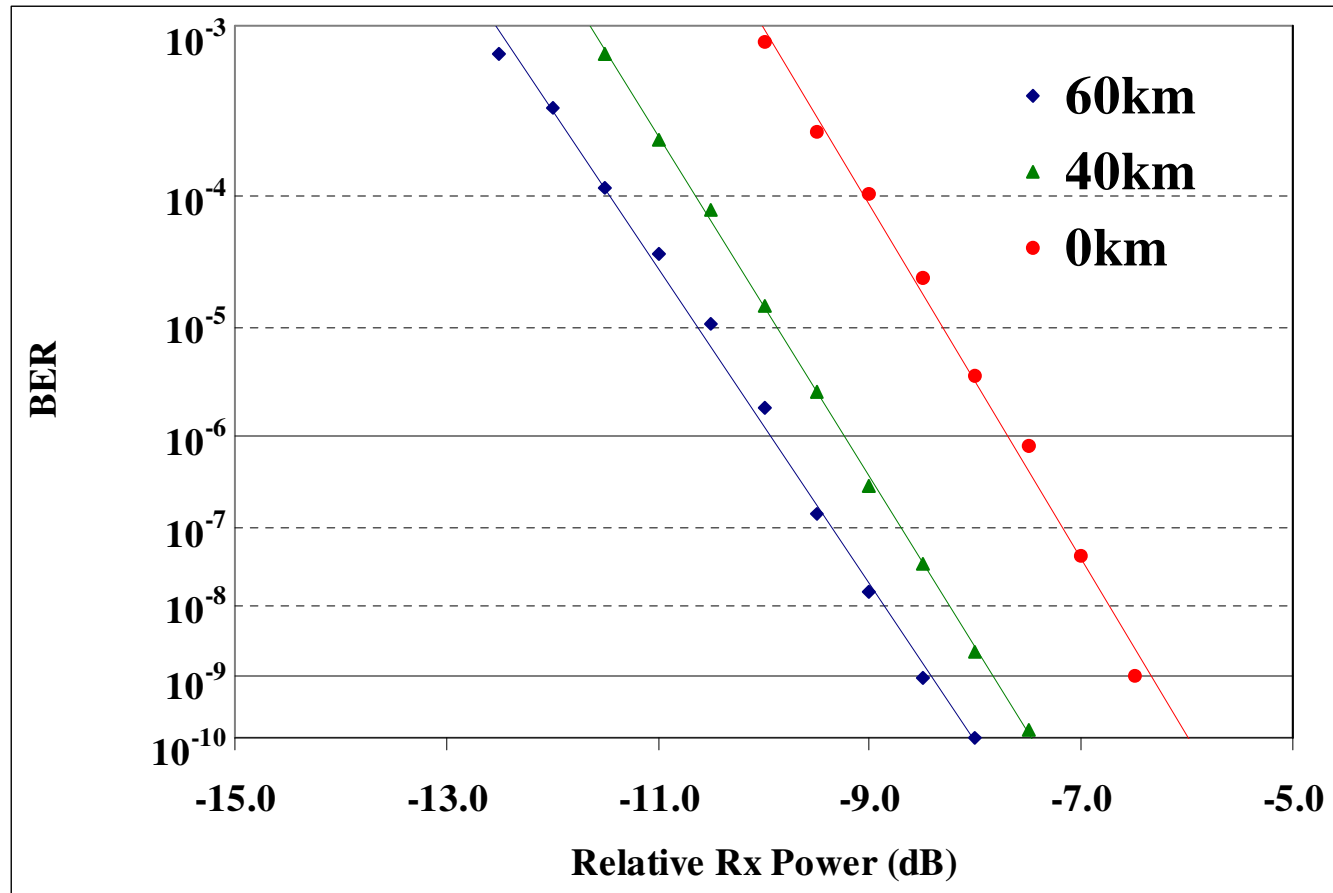

- Low ER (3dB) (Cooled laser)
- >1.5dB improvement for 40km; 2dB improvement for 60km

Laser Rate Equation Model

$$\frac{dn}{dt} = \frac{i(t)}{qV_a} - r[n(t)] - g_m[n(t), p(t)] \cdot p(t)$$

$$\frac{dp}{dt} = \left[\Gamma g_m[n(t), p(t)] - \frac{1}{\tau_{ph}} \right] \cdot p(t) + r_{sp}[n(t)]$$

$$\Delta\omega(t) = \frac{d\phi}{dt} = \frac{1}{2} \alpha \Gamma [g_m[n(t), 0] - g_m(N_{th}, 0)]$$

$$g_m(n, p) = G_0 \ln\left(\frac{n}{N_0}\right) \cdot \frac{1}{1 + \epsilon p}$$

$$r(n) = \frac{n}{\tau_s} + Bn^2 + Cn^3$$

$$r_{sp}(n) = \beta_{sp} Bn^2$$

n(t): carrier density

p(t): photon density

$\Delta\omega(t)$: instantaneous radial frequency

$\phi(t)$: instantaneous phase

q: electron charge

V_a : active layer volume

r(n): carrier recombination rate

$g_m(n, p)$: gain from stimulated emission

Γ : optical confinement factor (V_a/V_{opt})

τ_{ph} : photon lifetime

$r_{sp}(n)$: spontaneous emission in lasing mode

α : linewidth enhancement factor

N_{th} : threshold carrier density

G_0 : differential gain factor

N_0 : transparency density

ϵ : gain compression factor

τ_s : linear recombination time

B: bimolecular recombination coefficient

C: Auger recombination coefficient

β_{sp} : spontaneous emission factor

Linear Fiber Propagation Model

$$e(t,0) = \sqrt{p(t)}e^{i\phi(t)}$$

$$\tilde{E}(\omega,0) = \int_{-\infty}^{+\infty} e(t,0)e^{-i\omega t} dt$$

$$\tilde{E}(\omega,L) = \tilde{E}(\omega,0)e^{+i\beta_2\omega^2}$$

$$e(t,L) = \frac{1}{2\pi} \int_{-\infty}^{+\infty} \tilde{E}(\omega,L)e^{+i\omega t} d\omega$$

$$\beta_2 = \frac{\lambda^2}{4\pi c} DL$$

$e(t,0)$: complex field amplitude at distance 0

$e(t,L)$: complex field amplitude at distance L

$\tilde{E}(\omega,0)$: optical spectrum at distance 0

$\tilde{E}(\omega,L)$: optical spectrum at distance L

D: fiber dispersion (= 17ps/nm/km)

L: wavelength (=1550nm)

c: speed of light

Simulations & Measurements Eye Diagram

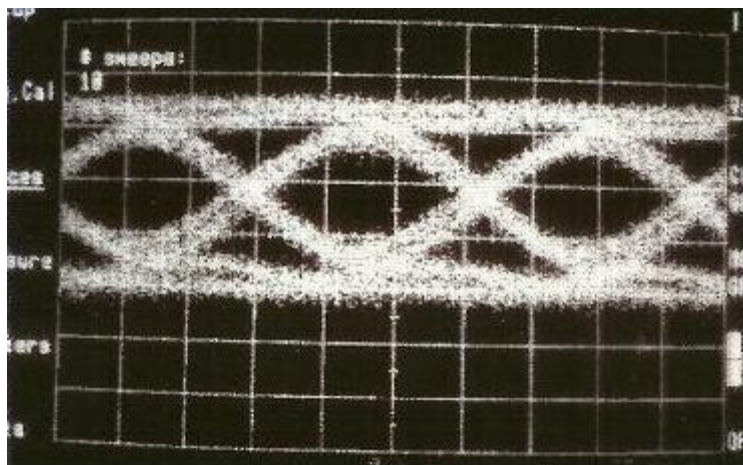

0km, ER=3.0dB

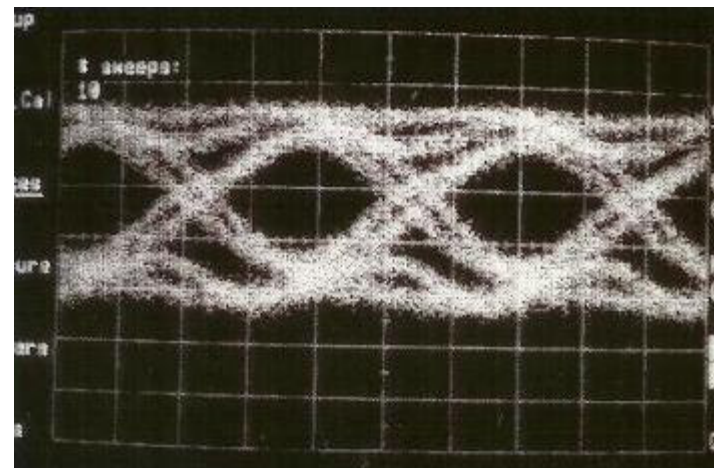
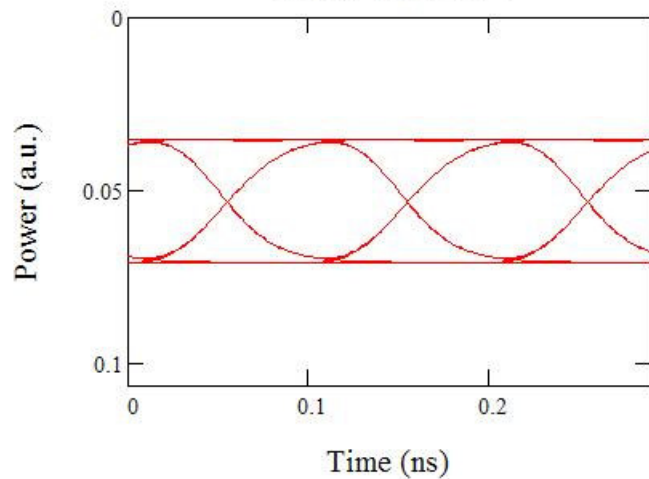

20km, ER=3.0dB

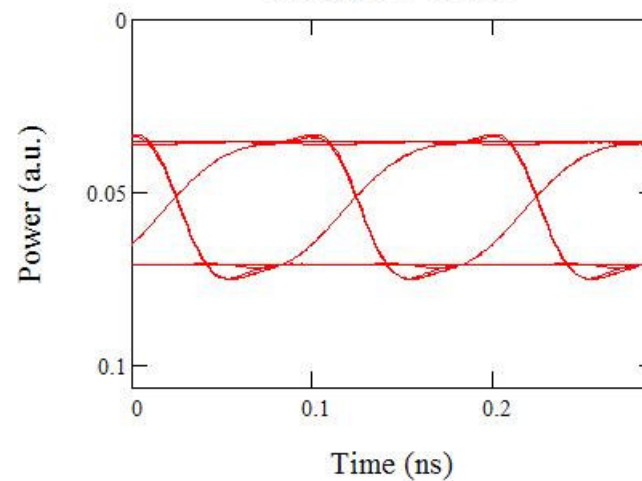

Simulations & Measurements Eye Diagram

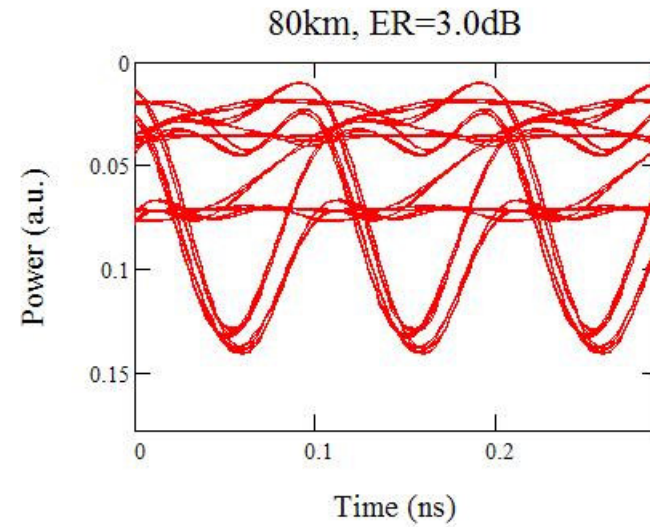
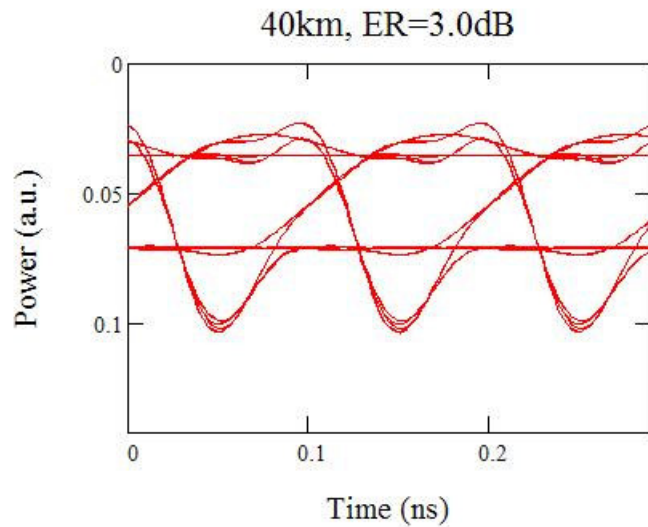
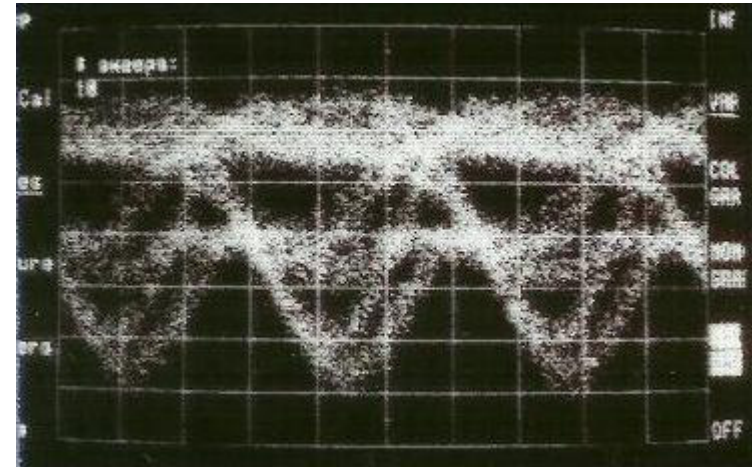
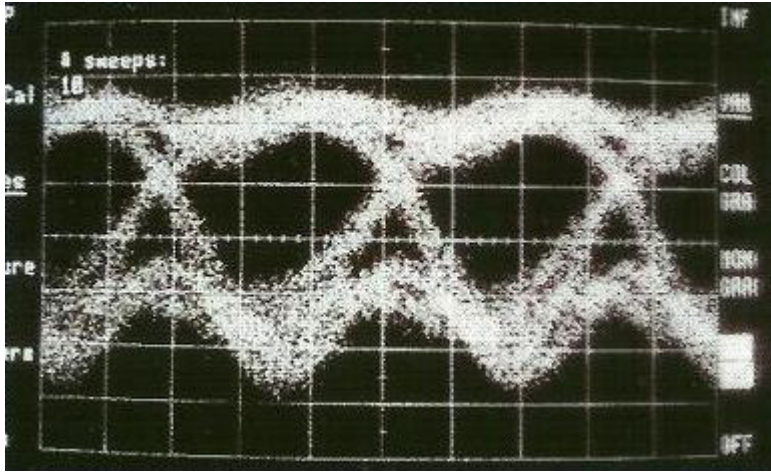

Simulations & Measurements Pulse

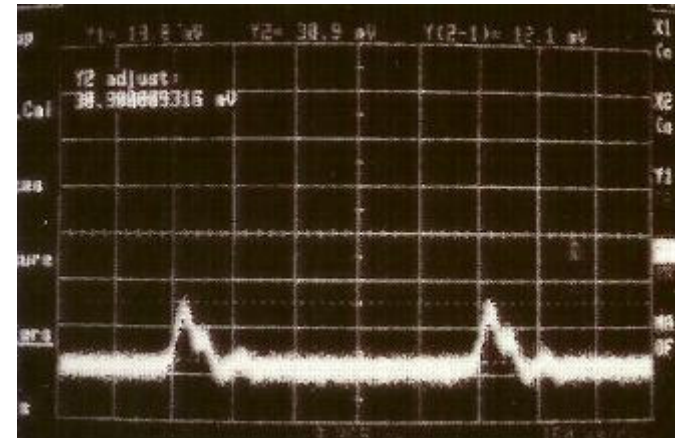
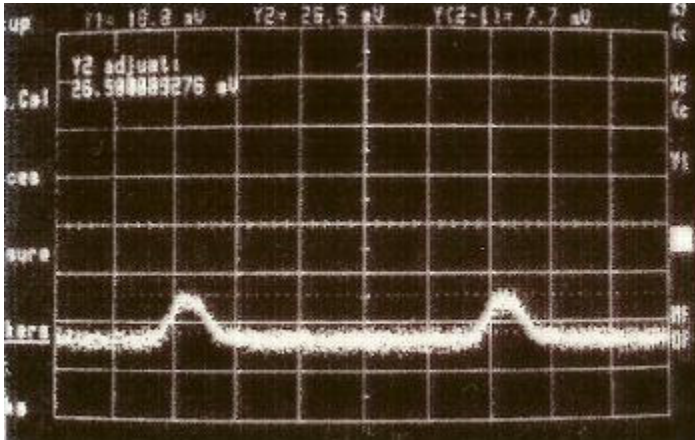

Pulse 0km

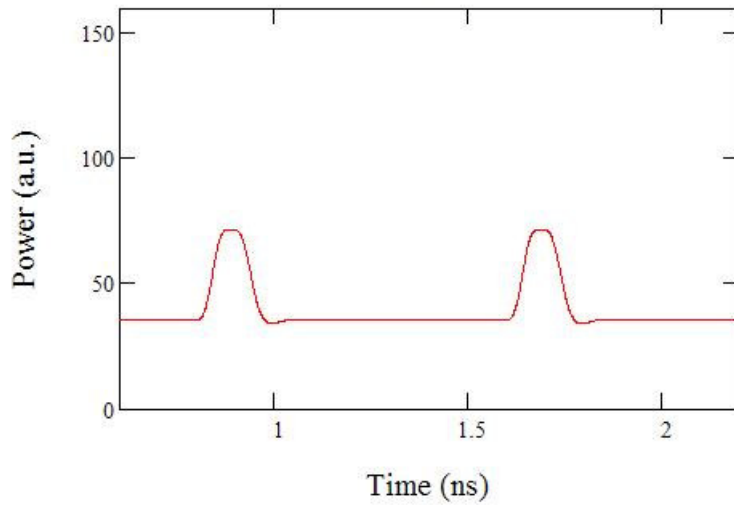

Pulse 20km

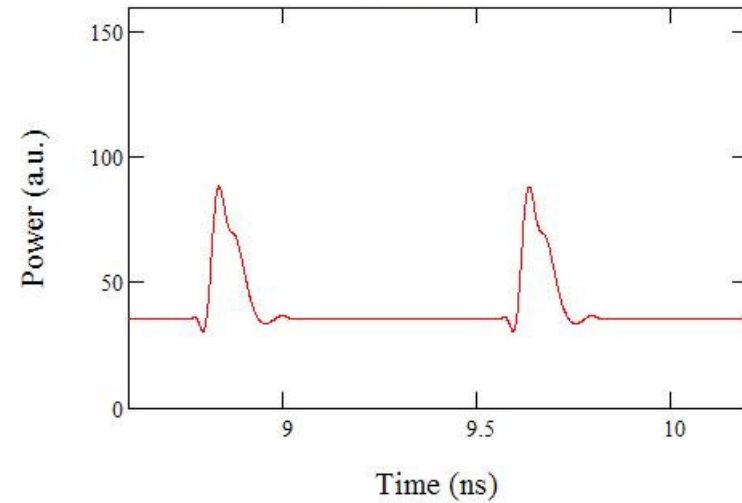

Dynamic and Transient Chirp

$$\Delta\nu(t) \approx \frac{\alpha}{4\pi} \left[\underbrace{\frac{1 + \epsilon p(t)}{p(t)} \frac{dp}{dt}}_{\text{Dynamic or transient chirp}} + \underbrace{\kappa p(t)}_{\text{Adiabatic or low frequency chirp}} \right] \quad \kappa = \frac{\epsilon}{\tau_{ph}}$$

- Dynamic/Transient chirp:
 - Only when laser power changes in time
 - $\sim \Delta p$ (change in power)
 - $\sim 1/\Delta t = f$ (frequency)
 - $\sim 1/p$ (1/power)
- Adiabatic/low frequency chirp
 - Also present at DC
 - Wavelength difference between 0 and 1
 - In addition to thermal chirp (which is not included here)

Chirp for High Extinction Ratio

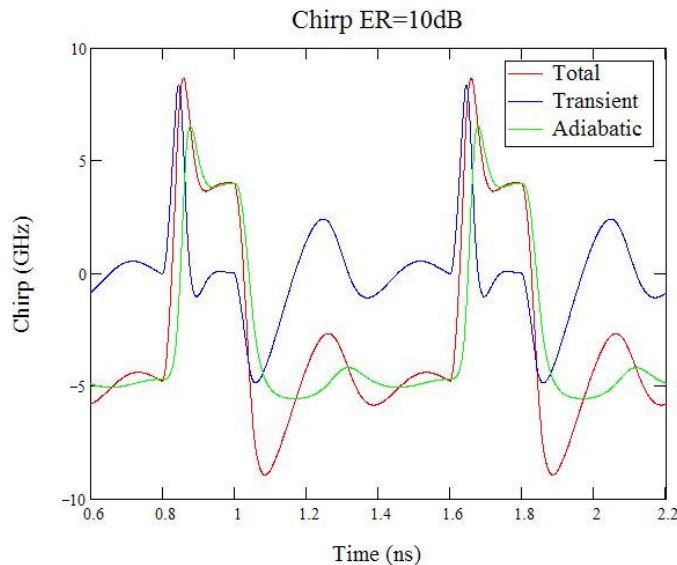
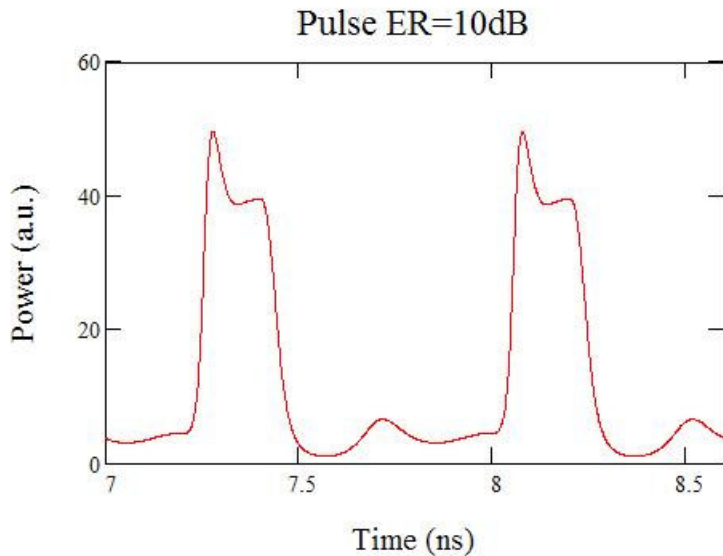

- Chirp contains both strong transient and strong adiabatic component
- Laser ringing from relaxation frequency increases the transient chirp
- Chirp on rising edge and falling edge are different due to strong transient chirp
- Different wavelength in rising and falling edge causes edges to travel at different speeds through fiber due to dispersion, resulting in the well known ISI problem

Chirp for Low Extinction Ratio

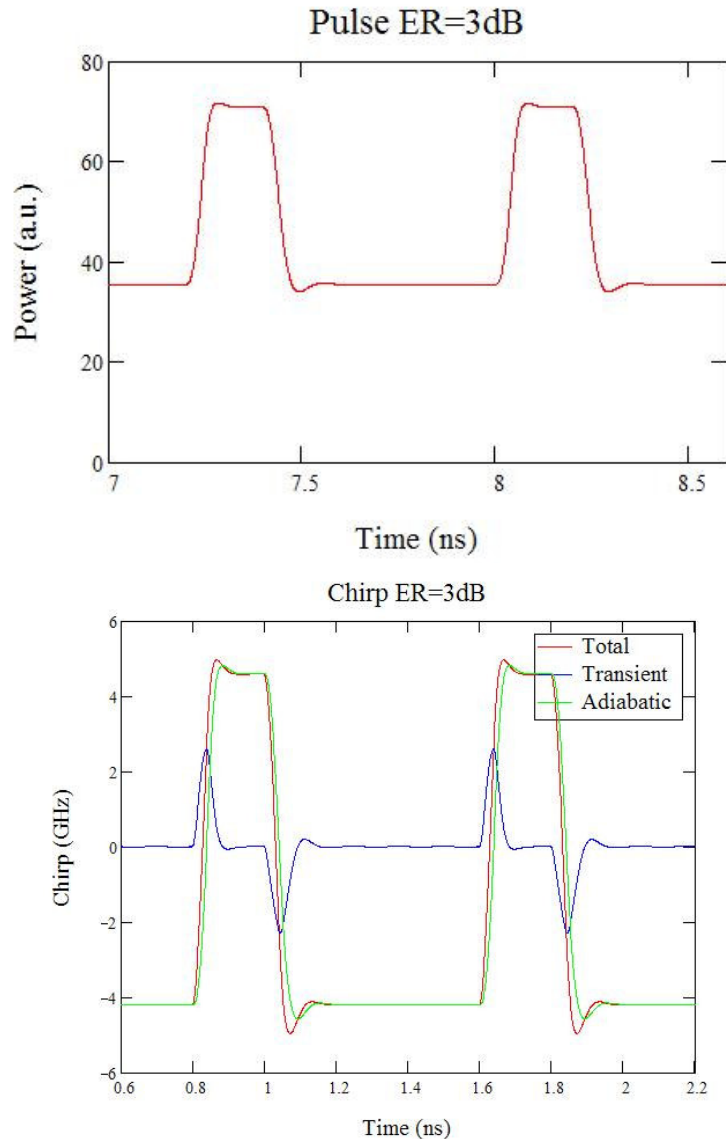

- Chirp is dominated by adiabatic chirp. Transient chirp is reduced
- Laser ringing from relaxation frequency is much weaker due to strong damping at higher power, resulting in additional transient chirp reduction
- Chirp on rising edge and falling edge are about the same due to adiabatic chirp dominating
- Fiber dispersion effect on edges is much suppressed

Adiabatic Chirp and Dispersion

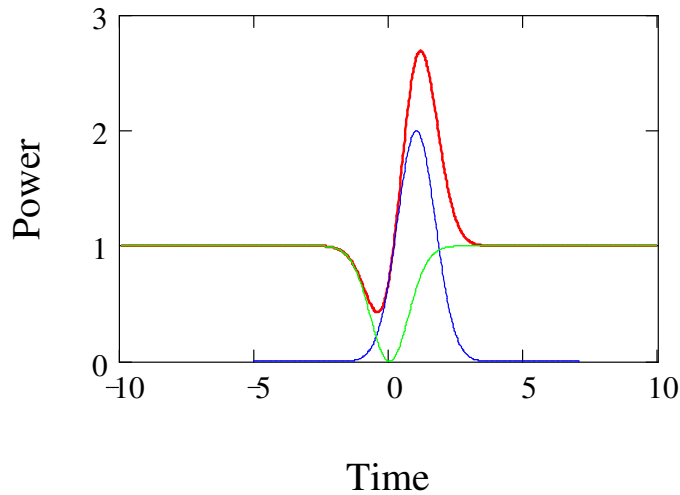
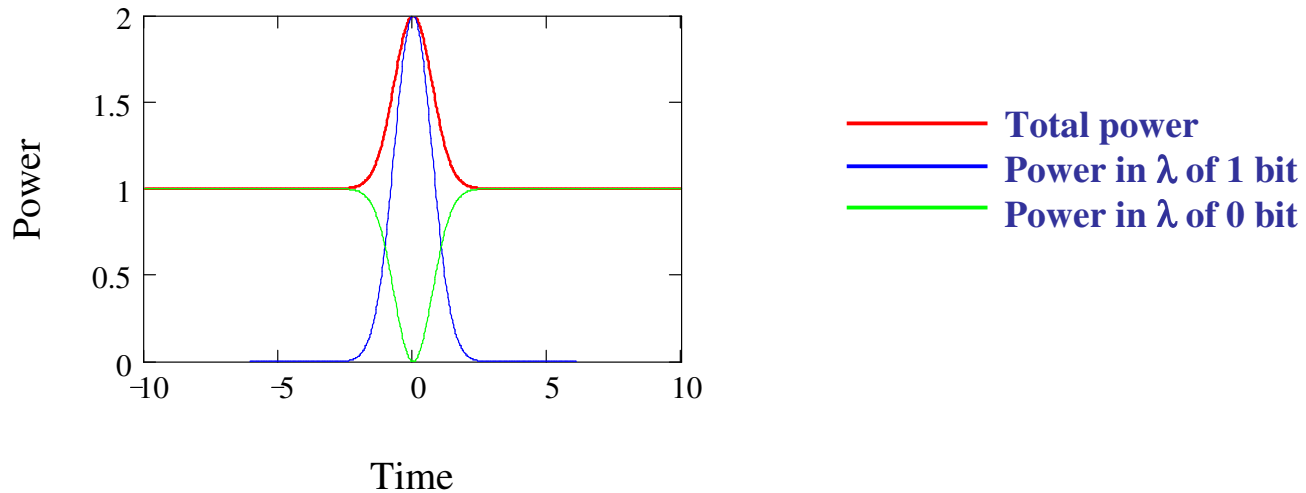

Wavelength of 1 bit travels slower than wavelength of 0 bit

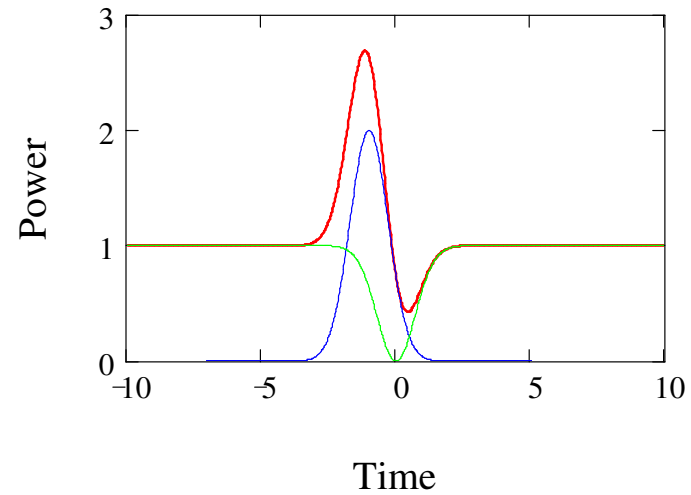

Wavelength of 1 bit travels faster than wavelength of 0 bit

It doesn't matter what the respective signs of chirp and dispersion are: the pulse gets "compressed"

$$D=17\text{ps/nm/km}, L=40\text{km}, \Delta\tau=50\text{ps}, \rightarrow \Delta\lambda=0.075\text{nm}$$

3av_0701_schrans_1

Pulse compression from Adiabatic Chirp and Dispersion

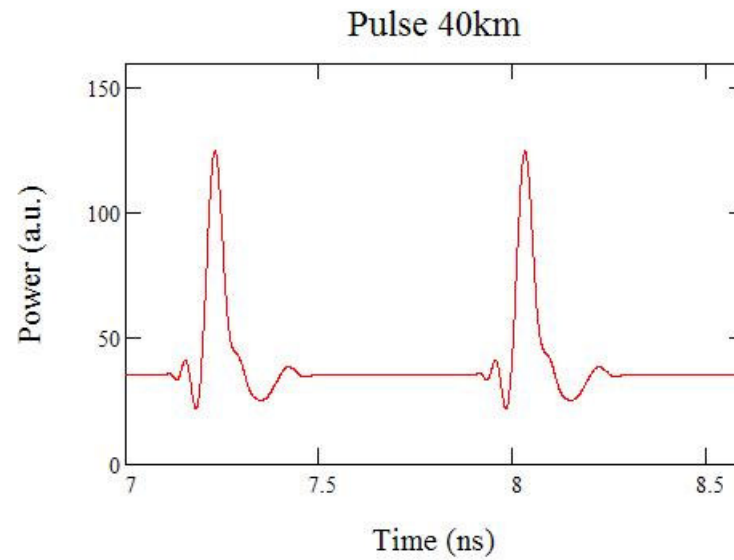
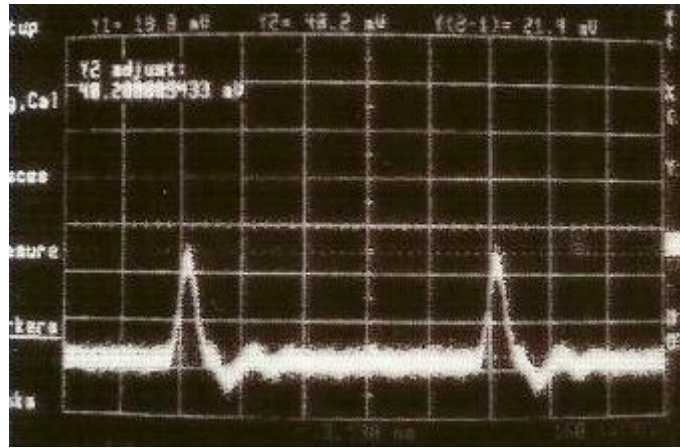

Measurement of the Adiabatic Chirp

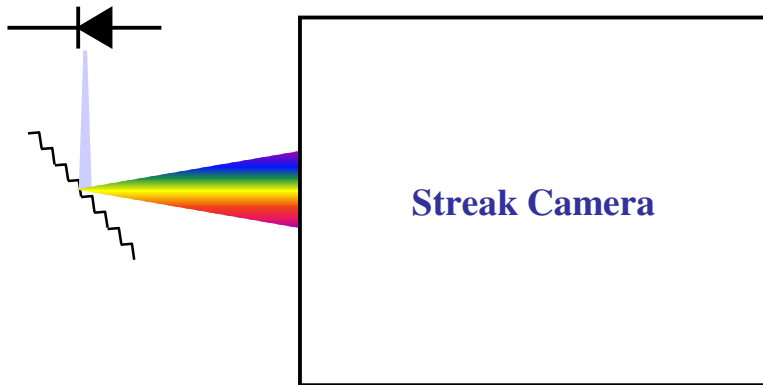

Grating disperses the wavelengths along the slit (vertical direction) of the streak camera
Streak camera sweeps the signal in the horizontal direction → time

Today this can be done with a OSA with monochromator output

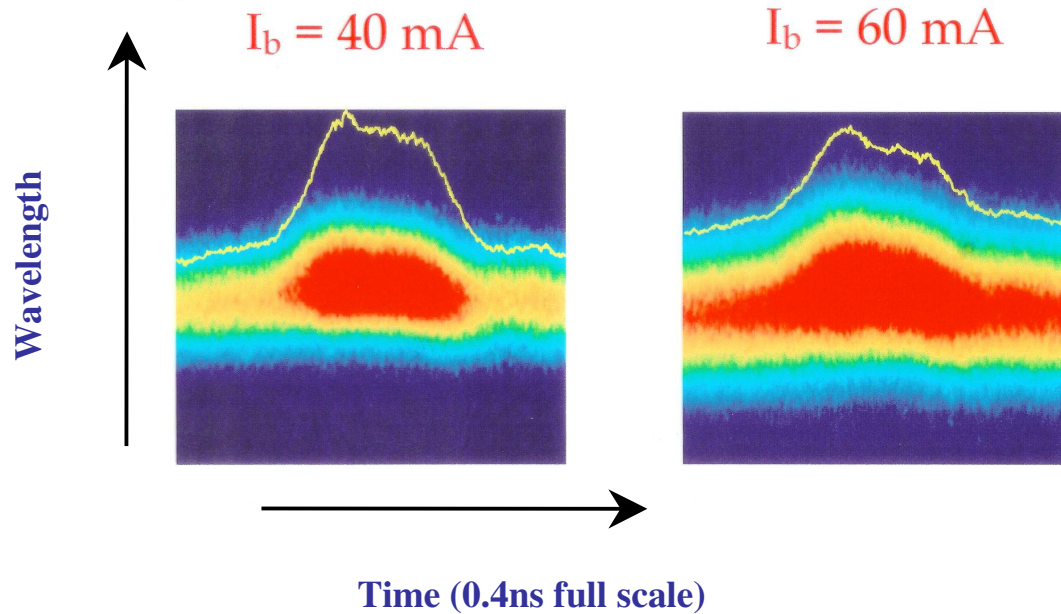

Chirp Measurement Result

2D images on streak camera: $P(\lambda, t)$

Instantaneous wavelength: $\lambda(t)$ (average over vertical direction for each t)

$$\lambda(t) = \frac{\int \lambda P(\lambda, t) d\lambda}{\int P(\lambda, t) d\lambda}$$

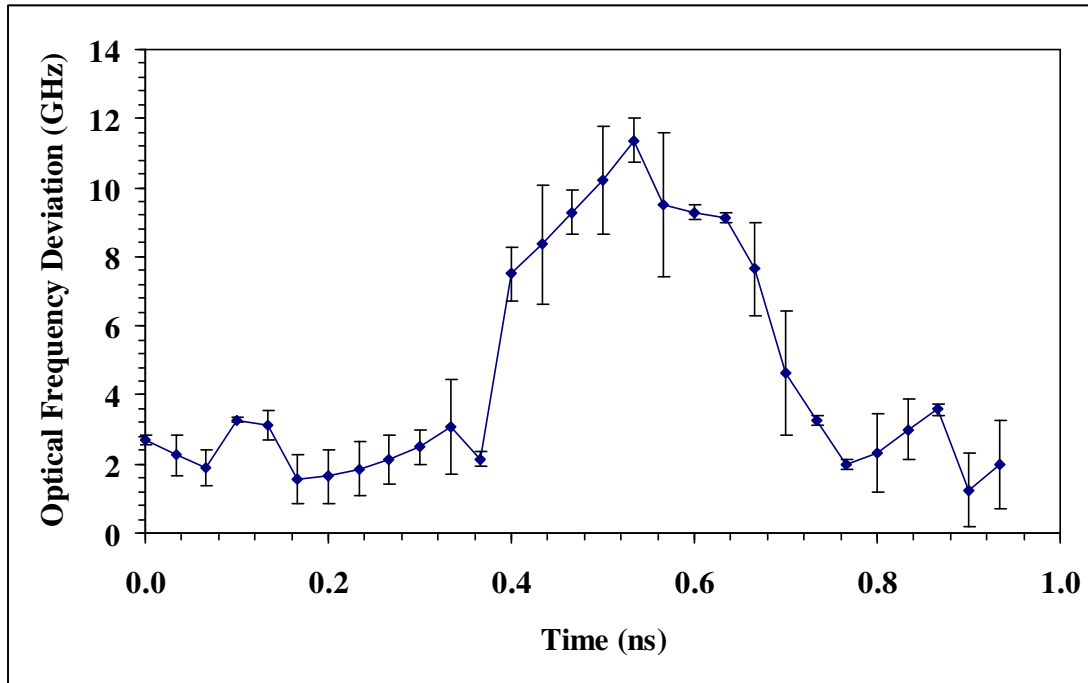

10GHz = 0.08nm
@1550nm

The sign of the Adiabatic Chirp or Dispersion does not matter

$D > 0$

$D < 0$

$K > 0$

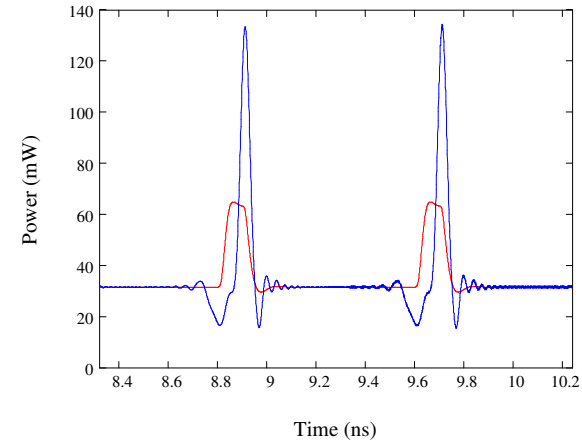
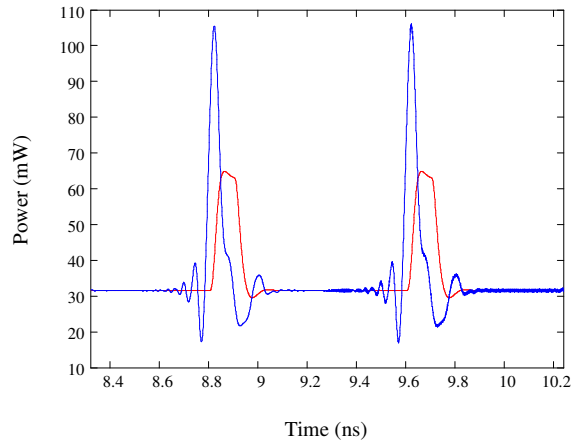

$K < 0$

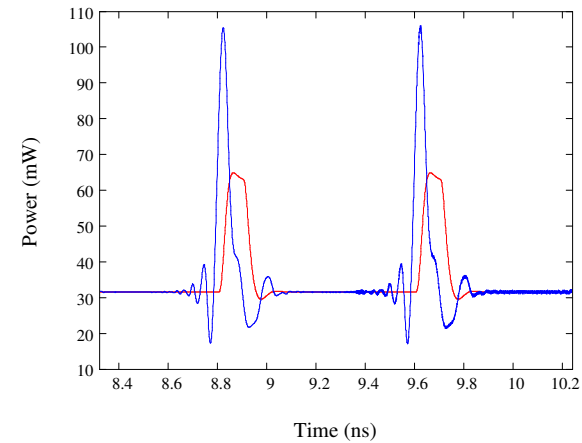
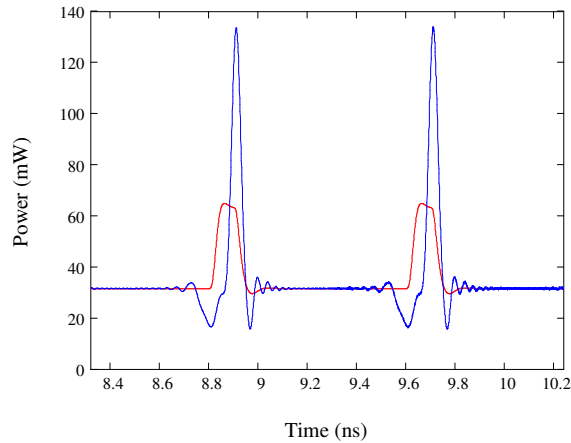

Impact of Low Extinction Ratio

- OC192, 1310nm, 10km: $Er_{\min} = 6\text{dB}$
- 10GBASE-L (1310nm, 10km): $Er_{\min} = 3.5\text{dB}$
- 10GBASE-E (1550nm, 40km): $Er_{\min} = 3.0\text{dB}$
- 802.3 has already converted to OMA for 10G instead of Er
 - For link performance it is really the OMA on the receiver that matters most

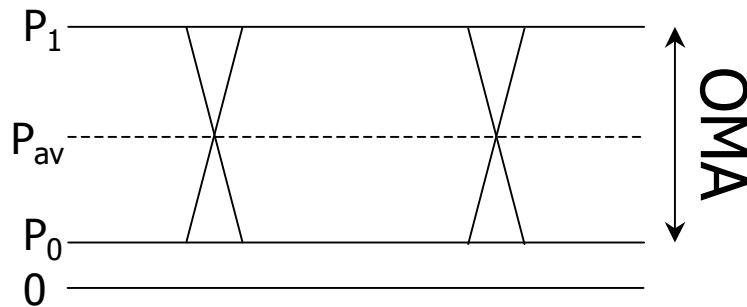

$$r_E = \frac{P_1}{P_0} \quad ER = 10\log(r_E)$$

$$OMA = P_1 - P_0 = 2P_{av} \frac{r_E - 1}{r_E + 1}$$

$$\Rightarrow P_{av} = \frac{OMA}{2} \frac{r_E + 1}{r_E - 1}$$

Extinction Ratio and Average Power Penalty

- In order to meet constant OMA, more average power is needed for decreasing Er

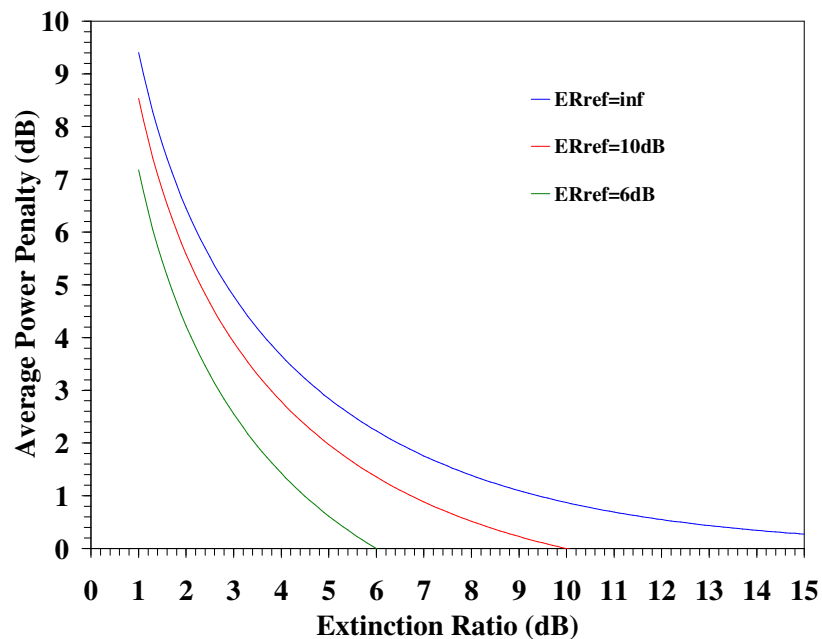

- OMA is what matters for link performance
- Can Rx handle increased DC current
 - Due to PON architecture ONU Rx will never see full max Tx power
- Fiber nonlinearities
- Eye safety
- 802.3 has already moved to lower Er for 10Gb/s

Summary

- Properly designed 1550 DML could be used for 10Gb/s over 20km of SMF-28
 - Controlling the adiabatic chirp and the transient chirp through
 - the relaxation frequency damping
 - Modulation at low ER
 - link performance up to 60km has been demonstrated with -2dB dispersion penalty more than 10 years ago for cooled laser
- The 60km performance for cooled laser should be enough margin to achieve +1dB dispersion penalty over 20km for uncooled laser

Other publicized work discussing similar phenomenon

- DST (Dispersion Supported Transmission) as introduced by Alcatel

(Wedding, Electronics Letters Vol 28(14), 1298-1300, 1992)

Pure FM modulation of laser:

wavelength of 1 bit is different from wavelength of 0 bit, but $P(t) = \text{constant}$

- FM to AM conversion by propagation through dispersive link

(Binder et al., IEEE PTL Vol 6(4), 558-560, 1994)

Other References

- 1550NM 10Gb/S DML
 - Mohrdiek et al., IEEE PTL Vol 7(11), 1357-1359, 1995
- Adiabatic and Transient Chirp and transmission:
 - Koch et al., Electronics Letters Vol 20, 1038-1039, 1984
 - Binder et al., IEEE PTL Vol 6(4), 558-560, 1994
 - Peral et al., IEEE J-LT Vol 18(1), 84-89, 2000
 - Tomkos et al., IEEE Sel Topics in QE Vol 7(3), 439-460, 2001
- Dispersion Supported Transmission (DST):
 - Heideman et al., Proc IEEE Vol 81(11), 1558-1567, 1993
 - Wedding, Electronics Letters Vol 28(14), 1298-1300, 1992