



IEEE P802.3ba 40Gb/s and 100Gb/s Ethernet Task Force

Agenda and General Information

San Francisco, Ca
July, 2009



Agenda

- Welcome and Introductions
- Approve Agenda
- Approve the Minutes
- Goals for this Week
- Ground Rules
- Reflector and Web
- IEEE
 - Structure
 - Bylaws and Rules
 - Call for Patents
 - IEEE Standards Process
- Opening Reports (Chief Editor, Sub-Task Force Chairs)
- Liaisons
- Comment Resolution D2.1
- Motions & Closing Business
- Future Meetings

Task Force Decorum



- Press (i.e., anyone reporting publicly on this meeting) are to announce their presence (2007 SASB Op Manual 5.3.3.5)
- Photography or recording by permission only (5.3.3.4)
- Cell phone ringers off
- Wear your badges at all times in meeting areas

Goals for the Week

- Progress Towards Sponsor Ballot
 - Respond to comments against IEEE P802.3ba Draft 2.1
- Lay groundwork for the next meeting
 - Draft 2.2
- Big Ticket Items
 - Resolution of 40GBASE-CR4 / 100GBASE-CR10 Reach / Budget Allocation
 - Nomenclature

IEEE P802.3ba Task Force Officers and Editors

<u>John D'Ambrosia</u>	Task Force Chair
<u>Ilango Ganga</u>	Task Force Chief Editor Editor – Clauses 1, 4, 80, Annexes A, 4A
<u>Mark Gustlin</u>	Chair, “Logic” Sub-task Force Editor – Clauses 81, 82
<u>Chris DiMinico</u>	Chair, “Cu” Sub-task Force Editor – Clause 85
<u>Pete Anslow</u>	Chair, “Optical” Sub-task Force Editor – Clause 88
<u>Hugh Barrass</u>	Editor – Clauses 30, 45
<u>Jonathan King</u>	Editor – Clause 87
<u>Arthur Marris</u>	Editor – Clauses 69, 73, 74, 84, Annexes 69A, 69B
<u>Steve Trowbridge</u>	Editor – Clause 83, Annex 83C
<u>Ryan Latchman</u>	Editor – Annex 83A, 83B Chair, “nAUI” Ad Hoc
<u>Piers Dawe</u>	Editor – Clause 86, 52 Chair – “Statistical Eye” Ad Hoc
<u>Alessandro Barbieri</u>	Co-chair – Extended Reach Parallel MMF Ad Hoc
<u>John Petrilla</u>	Co-chair - Extended Reach Parallel MMF Ad Hoc
<u>George Oulundsen</u>	Task Force Secretary
<u>Frank Chang</u>	Task Force Web Master

Ground Rules

- Based upon IEEE 802.3 Rules
 - Foundation based upon Robert's Rules of Order
 - Anyone in the room may speak
 - Anyone in the room may vote
- **RESPECT**... give it, get it
- NO product pitches
- NO corporate pitches
- NO prices!!!
 - This includes costs, ASPs, etc. no matter what the currency
- NO restrictive notices

Reflector and Web

- To subscribe to the IEEE P802.3ba Task Force reflector, send an email to:

ListServ@ieee.org

with the following in the body of the message (do not include “<>”):

***subscribe stds-802-3-hssg <yourfirstname> <yourlastname>
end***

- Send IEEE P802.3ba Task Force reflector messages to:

STDS-802-3-HSSG@listserv.ieee.org

- Task Force web page URL:

http://www.ieee802.org/3/ba/

IEEE P802.3ba Private Area

- URL: <http://www.ieee802.org/3/ba/private/>
 - Username: 802.3ba
 - Password: xxxxxxx

- Write it down...

- Note - The draft is posted for your review only, and neither the draft nor access information should be copied or redistributed to others in violation of document copyrights.

Task Force Approved Project Documents

■ PAR

- http://ieee802.org/3/ba/PAR/par_0308.pdf

■ 5 Criteria

- http://ieee802.org/3/ba/PAR/P802.3ba_5C_0908.pdf

■ Objectives

- http://ieee802.org/3/ba/PAR/P802.3ba_Objectives_0308.pdf

IEEE Structure

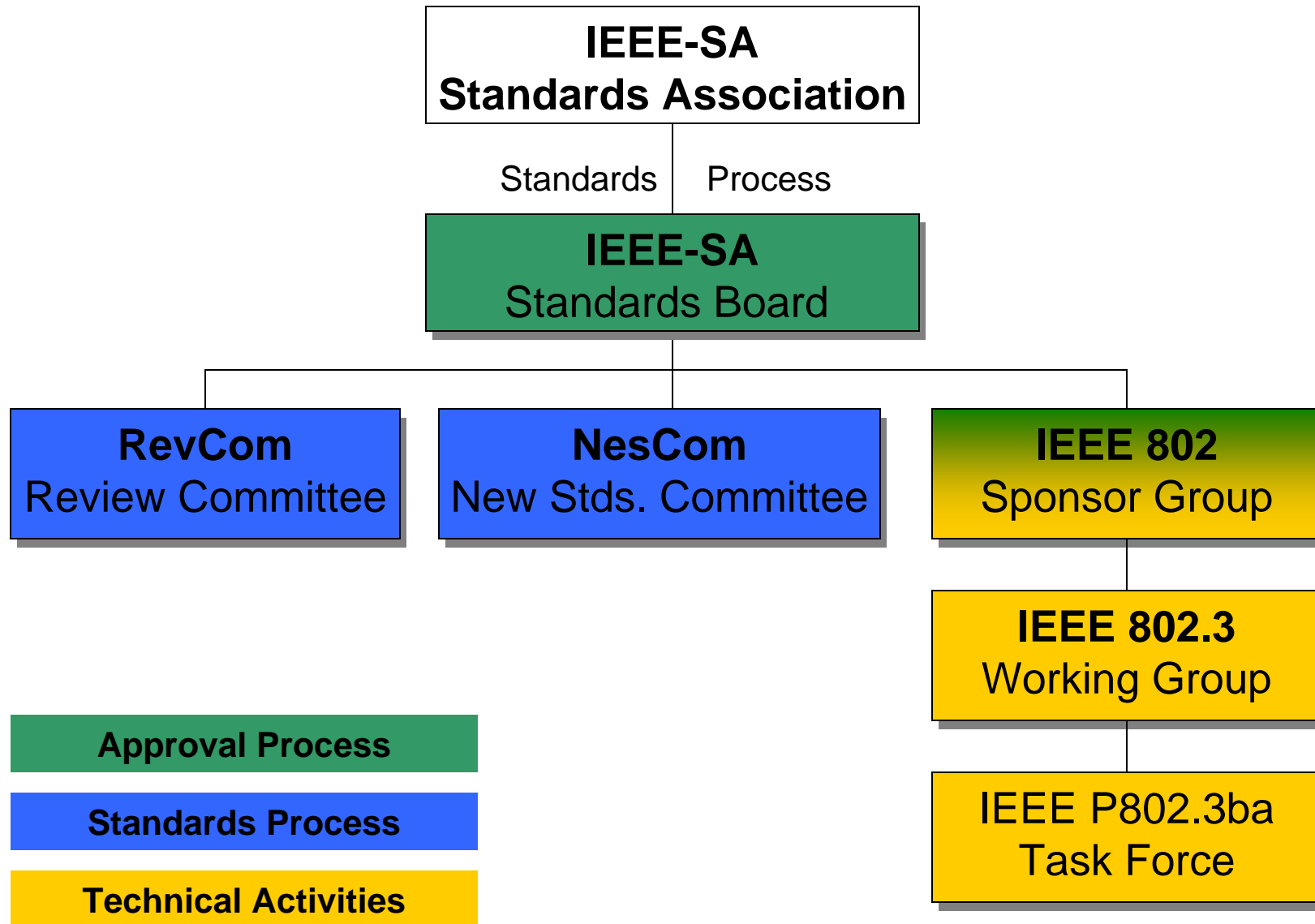

Bylaws and Rules

- **IEEE-SA Operations Manual:**
 - <http://standards.ieee.org/sa/sa-om.pdf>
- **IEEE-SA Standards Board Bylaws:**
 - <http://standards.ieee.org/guides/bylaws/sb-bylaws.pdf>
- **IEEE-SA Standards Board Operations Manual:**
 - <http://standards.ieee.org/guides/opman/sb-om.pdf>
- **IEEE 802 LAN/MAN Standards Committee (LMSC) Policies and Procedures:**
 - http://standards.ieee.org/board/aud/LMSC_2009.pdf
- **IEEE 802 LAN/MAN Standards Committee (LMSC) Operations Manual:**
 - http://www.ieee802.org/PNP/2008-11/LMSC_OM_approved_081114.pdf
- **IEEE 802.3 Working Group Operating Rules:**
 - http://ieee802.org/3/rules/P802_3_rules.pdf

Participants, Patents, and Duty to Inform

All participants in this meeting have certain obligations under the IEEE-SA Patent Policy. Participants:

- ❑ “Shall inform the IEEE (or cause the IEEE to be informed)” of the identity of each “holder of any potential Essential Patent Claims of which they are personally aware” if the claims are owned or controlled by the participant or the entity the participant is from, employed by, or otherwise represents
 - “Personal awareness” means that the participant “is personally aware that the holder may have a potential Essential Patent Claim,” even if the participant is not personally aware of the specific patents or patent claims
- ❑ “Should inform the IEEE (or cause the IEEE to be informed)” of the identity of “any other holders of such potential Essential Patent Claims” (that is, third parties that are not affiliated with the participant, with the participant’s employer, or with anyone else that the participant is from or otherwise represents)
- ❑ The above does not apply if the patent claim is already the subject of an Accepted Letter of Assurance that applies to the proposed standard(s) under consideration by this group

Quoted text excerpted from IEEE-SA Standards Board Bylaws subclause 6.2

- Early identification of holders of potential Essential Patent Claims is strongly encouraged
- No duty to perform a patent search

Patent Related Links

All participants should be familiar with their obligations under the IEEE-SA Policies & Procedures for standards development.

Patent Policy is stated in these sources:

IEEE-SA Standards Boards Bylaws

<http://standards.ieee.org/guides/bylaws/sect6-7.html#6>

IEEE-SA Standards Board Operations Manual

<http://standards.ieee.org/guides/opman/sect6.html#6.3>

Material about the patent policy is available at

<http://standards.ieee.org/board/pat/pat-material.html>

If you have questions, contact the IEEE-SA Standards Board Patent Committee Administrator at patcom@ieee.org or visit <http://standards.ieee.org/board/pat/index.html>

This slide set is available at <http://standards.ieee.org/board/pat/pat-slideset.ppt>

Call for Potentially Essential Patents

- If anyone in this meeting is personally aware of the holder of any patent claims that are potentially essential to implementation of the proposed standard(s) under consideration by this group and that are not already the subject of an Accepted Letter of Assurance:
 - Either speak up now or
 - Provide the chair of this group with the identity of the holder(s) of any and all such claims as soon as possible or
 - Cause an LOA to be submitted

Other Guidelines for IEEE WG Meetings

- **All IEEE-SA standards meetings shall be conducted in compliance with all applicable laws, including antitrust and competition laws.**
 - **Don't discuss the interpretation, validity, or essentiality of patents/patent claims.**
 - **Don't discuss specific license rates, terms, or conditions.**
 - Relative costs, including licensing costs of essential patent claims, of different technical approaches may be discussed in standards development meetings.
 - Technical considerations remain primary focus
 - **Don't discuss or engage in the fixing of product prices, allocation of customers, or division of sales markets.**
 - **Don't discuss the status or substance of ongoing or threatened litigation.**
 - **Don't be silent if inappropriate topics are discussed ... do formally object.**

See *IEEE-SA Standards Board Operations Manual*, clause 5.3.10 and "Promoting Competition and Innovation: What You Need to Know about the IEEE Standards Association's Antitrust and Competition Policy" for more details.

Overview of IEEE 802.3 Standards Process (1/5)- Study Group Phase

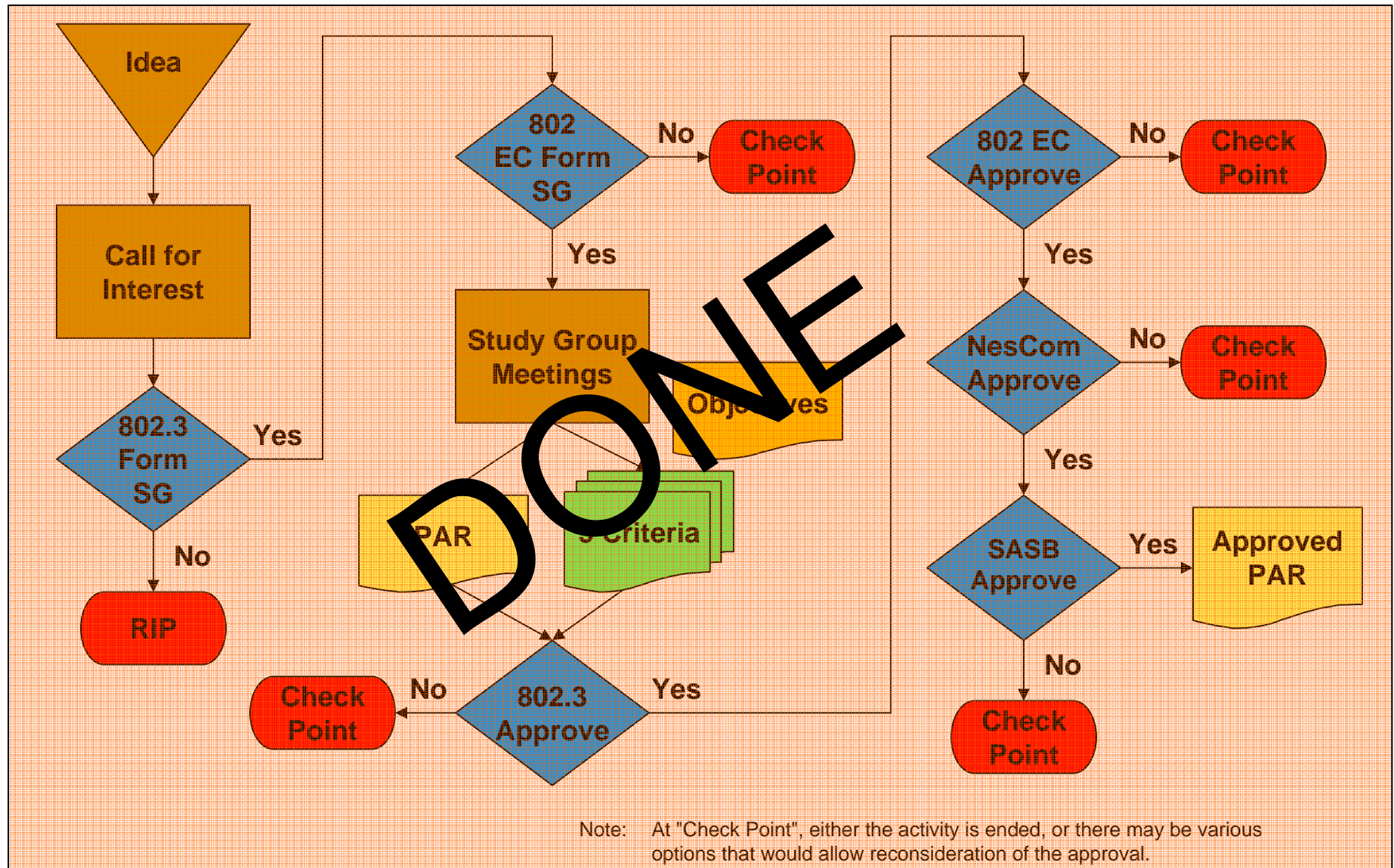

Overview of IEEE 802.3 Standards Process (2/5) - Task Force Comment Phase

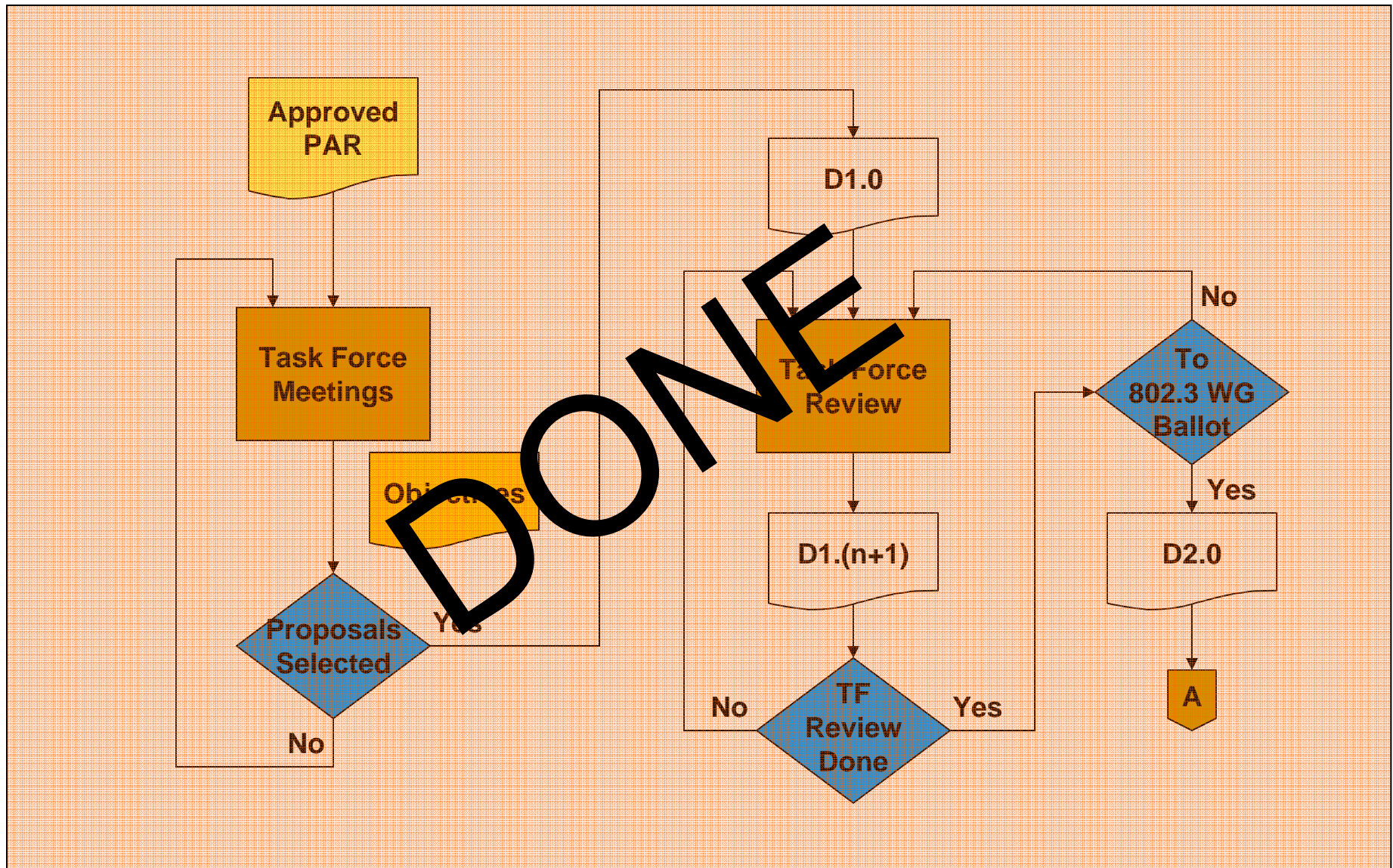

Overview of IEEE 802.3 Standards Process (3/5) - Working Group Ballot Phase

WE ARE HERE

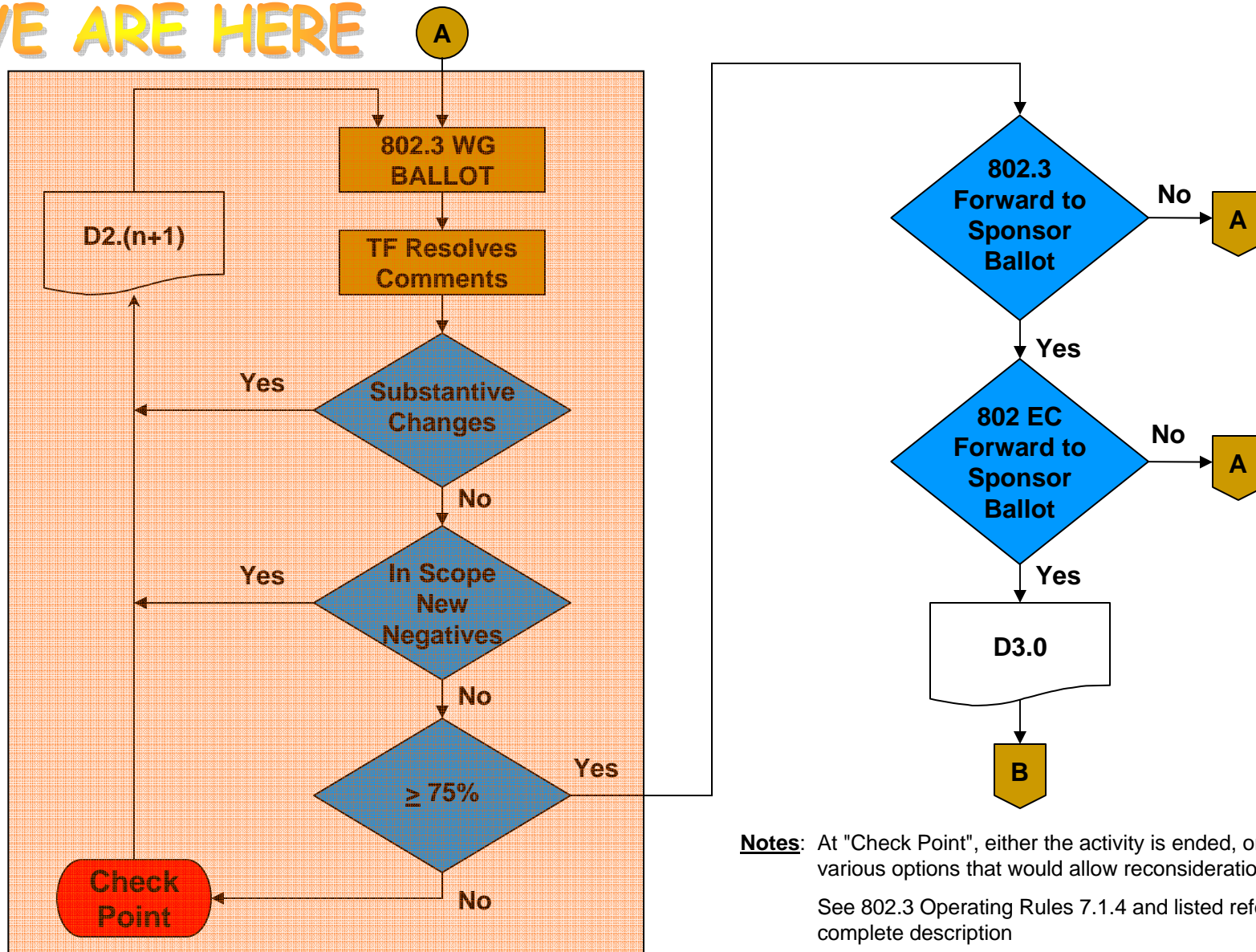

Notes: At "Check Point", either the activity is ended, or there may be various options that would allow reconsideration of the approval. See 802.3 Operating Rules 7.1.4 and listed references for complete description

Overview of IEEE 802.3 Standards Process (4/5)- Sponsor Ballot Phase

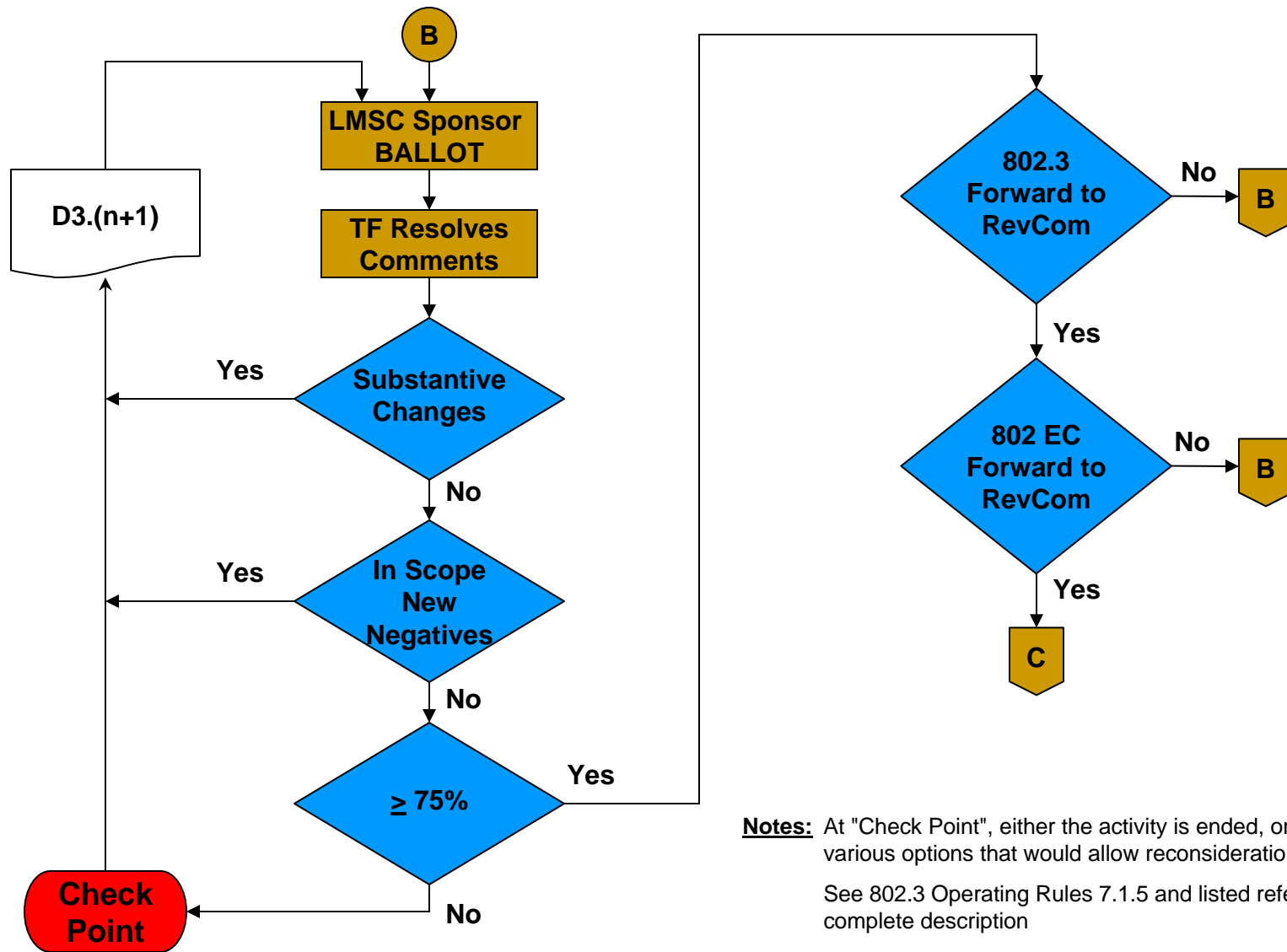

Notes: At "Check Point", either the activity is ended, or there may be various options that would allow reconsideration of the approval. See 802.3 Operating Rules 7.1.5 and listed references for complete description

Overview of IEEE 802.3 Standards Process (5/5) - Final Approvals / Standard Release

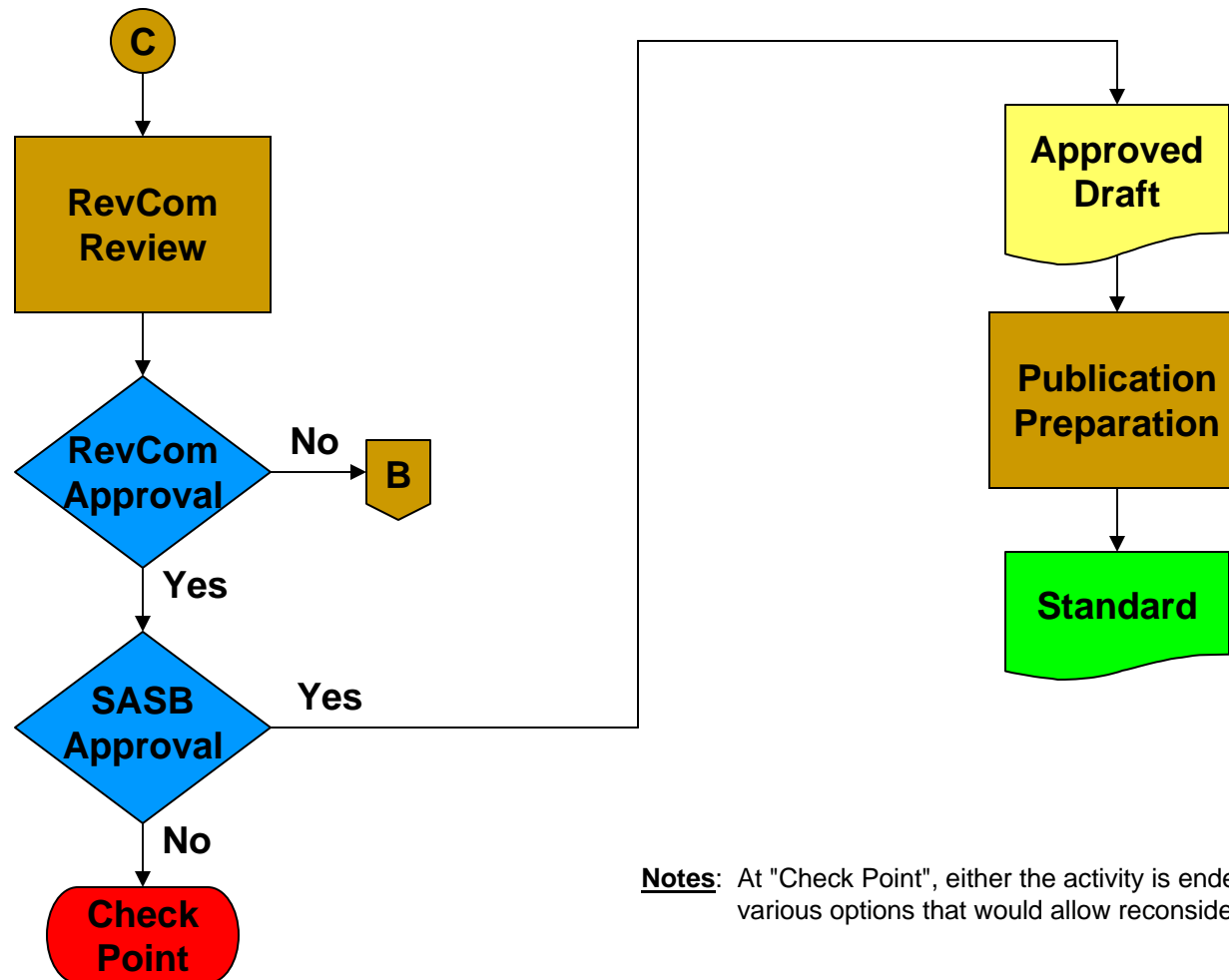

Notes: At "Check Point", either the activity is ended, or there may be various options that would allow reconsideration of the approval.

IEEE P802.3ba Task Force Timeline

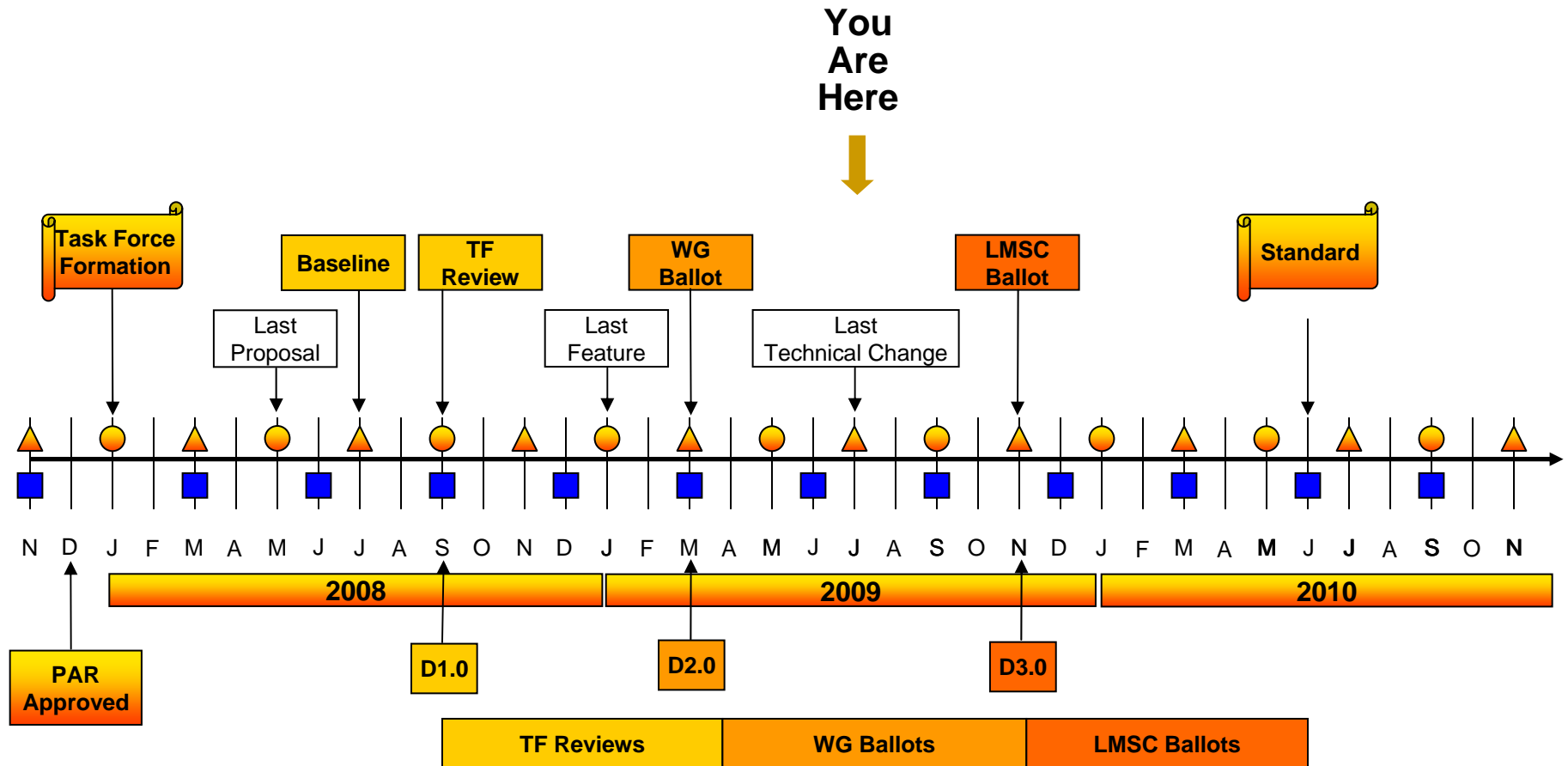

* Adopted by IEEE P802.3ba TF at March 08 Plenary

Meeting Map

	Sun	Mon	Tues	Wed	Thur	Fri				
8:00		SEC	Task Force			Logic	Copper	Optics	Task Force Motions & Closing Business	
8:30										
9:00										
9:30										
10:00										
10:30			Logic	Copper	Optics					
11:00		802.0 Plenary								
11:30										
12:00		Lunch	Lunch			Lunch		Lunch		
12:30										
13:00	Task Force	802.3 Plenary	Logic	Copper	Optics	Logic	Copper	Optics	802.3 Plenary	SEC
13:30										
14:00										
14:30										
15:00										
15:30										
16:00										
16:30										
17:00										
17:30										
18:00	Dinner	Tutorial #1	Dinner			Dinner				
18:30										
19:00	Task Force	CFI	Logic	Copper	Optics	Social				
19:30										
20:00										
20:30										
21:00										
21:30										
22:00										

Note –Times listed are subject to change.

Sunday 12-Jul-09

Time	Presenter	Affiliation	Title	File Name
2:00 PM	John D'Ambrosia	Force10 Networks	Agenda and General Information	agenda_01_0709.pdf
2:30 PM	Ilango Ganga	Intel	Chief Editor's Opening Report	ganga_01_0709.pdf
3:00 PM	Mark Gustlin	Cisco	Logic SubTask Force - Opening Report	gustlin_01_0709.pdf
3:10 PM	Chris DiMinico	MC Communications	Cu SubTask Force - Opening Report	diminico_01_0709.pdf
3:20 PM	Pete Anslow	Nortel	Optical SubTask Force - Opening Report	anslow_01_0709.pdf
3:30 PM			Break	
3:45 PM	Alan Flatman	LAN Technologies	Liaison Report from ISO/IEC JTC 1/SC 25/WG 3 to IEEE 802.3 regarding optical fibre terminology	0709_ISO_IEC_WG3_to_802_3_N897.pdf
3:55 PM	Terry Cobb	Systimax	INCITS T11.2 Liaison Report 802.3	0709_T11_2.pdf
4:05 PM			Task Force Comment Resolution	anslow_04_0709.pdf
6:00 PM			Dinner	
7:00 PM			Task Force Comment Resolution - Comments 96, 165, 166 (CR Reach Discussion)	
8:30 PM			Break	
8:45 PM			Task Force Comment Resolution - Comments 96, 165, 166 (CR Reach Discussion)	
			Break for Day	

Tuesday 14-Jul-09

Time	Presenter	Affiliation	Title	File Name
8:00 AM	John D'Ambrosia	Force10 Networks	Opening Comments	
8:10 AM			Task Force Comment Resolution - Comments 255, 97 (Nomenclature), Other Comments	law_01_0709.pdf, kipp_01_0709.pdf
10:00 AM			Break	
10:30 AM			Sub-Task Force Meetings Begin	

Thursday 16-Jul-09

Time	Presenter	Affiliation	Title	File Name
8:30 AM	John D'Ambrosia	Force10 Networks	Opening Comments	
8:40 AM			Discussion	
9:10 AM	Mark Gustlin	Cisco	Logic Sub Task Force - Closing Report	gustlin_03_0109.pdf
9:25 AM	Chris DiMinico	MC Communications	Cu SubTask Force - Closing Report	diminico_03_0109.pdf
9:40 AM	Pete Anslow	Nortel	Optical SubTask Force - Closing Report	anslow_03_0109.pdf
9:55 AM			Break	
10:15 AM	Ilango Ganga	Intel	Chief Editor's Closing Report	ganga_02_0109.pdf
10:30 AM			Discussion, Motions, & Closing Business	
Noon			Adjourn	

Note – Order of presentations and times listed are subject to change.

Contact information

- A participant's web account information will be the official record for contact information
 - This information may be updated at any time by the participant
 - It is not subject to errors during transcription of a written record

- To obtain and maintain voting membership, you must maintain correct contact information in the official record

Voting privileges

- The rules regarding obtaining and maintaining that privilege are found here:
<http://www.ieee802.org/3/rules/member.html>
- To become a voter:
 - Complete and current contact information recorded in the Working Group 802.3 database.
 - You must attend and sign attendance book for at least 75% of sessions of two 802.3 WG plenary meetings (within the last four)
 - Full attendance at a two-day 802.3 WG Interim can be substituted for one Plenary
 - Request to become a voter during the opening or closing Plenary meeting when solicited by the Chair from the “potential voters list”
- To remain a voter
 - Maintain Complete and current contact information in the Working Group 802.3 database.
 - Have 75% attendance during at least two of the last four plenaries
 - Attendance at an interim can substitute for attendance at no more than 1 plenary
 - Participate in Working Group ballots.
 - You can be dropped for lack of participation !

Remember to Declare Your Affiliation

- From the IEEE SA Standards Board By-laws

- **5.2.1.5 Disclosure of affiliation** (<http://standards.ieee.org/guides/bylaws/sect5.html#5.2.1.5>)

- Every member and participant in a working group, Sponsor ballot, or other standards development activity shall disclose his or her affiliation. An individual is deemed "affiliated" with any individual or entity that has been, or will be, financially or materially supporting that individual's participation in a particular IEEE standards activity. This includes, but is not limited to, his or her employer and any individual or entity that has or will have, either directly or indirectly, requested, paid for, or otherwise sponsored his or her participation. Failure to disclose every such affiliation may result in complete or partial loss of rights to participate in IEEE-SA activities. An individual is not excused from compliance with this policy by reason of any claim of a conflicting obligation (whether contractual or otherwise) that prohibits disclosure of affiliation.

- From the IEEE SA Standards Board Operations Manual

- **5.3.3.1 Disclosure of affiliation** (<http://standards.ieee.org/guides/opman/sect5.html#5.3.3.1>)

- Each participant's affiliation shall be disclosed at any working group or project meeting. The chair or the chair's delegate shall inform the meeting of the requirement for disclosure of affiliation (see [5.2.1.5](#) of the *IEEE-SA Standards Board Bylaws*). This shall be via a sign-in (e.g., sign-in sheet, electronic sign-in, verbal disclosure, or electronic communication) that provides for disclosure of employer and any other affiliation, a reminder of the definition of affiliation, and possible penalties for non-compliance.

Whenever an individual is aware that the ownership of his or her employer or other affiliation may be material to the process, or when the Sponsor or the IEEE-SA Standards Board requests, that individual shall also declare the "ultimate parent entity" of their affiliation. The ultimate parent entity is an entity that directly or indirectly, through one or more intermediaries, controls the entity identified as the individual's affiliation. For the purposes of this definition, the term "control" and its derivatives, with respect to for-profit entities, means the legal, beneficial or equitable ownership, directly or indirectly, of more than fifty percent (50%) of the capital stock (or other ownership interest, if not a corporation) of an entity ordinarily having voting rights. "Control" and its derivatives, with respect to nonprofit entities, means the power to elect or appoint more than fifty percent (50%) of the Board of Directors of an entity.

- **5.3.3.2 False or misleading disclosure** (<http://standards.ieee.org/guides/opman/sect5.html#5.3.3.2>)

- A meeting attendee who fails to disclose affiliation shall not accrue any membership rights, including rights of or towards voting membership, until such disclosures have been made. The chair shall review the adequacy of disclosures. Failure to disclose affiliation, or materially false or misleading disclosure of affiliation, shall result in loss of membership privileges and may also result in loss of other participation privileges within the IEEE-SA for such participants and any affiliated entities

Future Meetings

- Future Meeting information at:
 - <http://ieee802.org/3/interims/index.html>
- Sept 2009 IEEE 802.3 Interim
 - Sept 21 - 25
 - Chicago, IL, USA
- Nov 2009 IEEE 802 Plenary
 - Nov 15 – 20
 - Hyatt Regency Atlanta
 - Atlanta, GA, USA
- Jan 2010 IEEE 802.3 Interim
 - To be announced
- March 2010 IEEE 802 Plenary
 - March 14 - 19
 - Caribe Royale Orlando All Suites Resort and Convention Center
 - Orlando, FL, USA



Thank You!

