



# IEEE P802.3ba 40Gb/s and 100Gb/s Ethernet Task Force

## Agenda and General Information

Orlando, FL, USA  
March, 2010



# Agenda

- Welcome and Introductions
- Approve Agenda
- Approve the Minutes
- Goals for this Week
- Ground Rules
- Reflector and Web
- IEEE
  - Structure
  - Bylaws and Rules
  - Call for Patents
  - IEEE Standards Process
- Opening Reports
- Liaisons & Informal Communications
- Comment Resolution D3.1
- Motions & Closing Business
- Future Meetings

# Task Force Decorum



- Press (i.e., anyone reporting publicly on this meeting) are to announce their presence (2007 SASB Op Manual 5.3.3.5)
- Photography or recording by permission only (5.3.3.4)
- Cell phone ringers off
- Wear your badges at all times in meeting areas

# Goals for the Week

## ■ Big Ticket Items

- ❑ Resolve comments received against D3.1
- ❑ Proceed to State of “STOP MAKING CHANGES”
- ❑ Lay groundwork for the next meeting - Draft 3.2
- ❑ Request Conditional Approval to submit to RevCom at closing IEEE 802.3 WG Plenary.

# IEEE P802.3ba Task Force Officers and Editors

<a href="#"><u>John D'Ambrosia</u></a>	Task Force Chair
<a href="#"><u>Ilango Ganga</u></a>	Task Force Chief Editor Editor – Clauses 1, 4, 80, Annexes A, 4A
<a href="#"><u>Mark Gustlin</u></a>	Chair, “Logic” Sub-task Force Editor – Clauses 81, 82
<a href="#"><u>Chris DiMinico</u></a>	Chair, “Cu” Sub-task Force Editor – Clause 85
<a href="#"><u>Pete Anslow</u></a>	Chair, “Optical” Sub-task Force Editor – Clause 88
<a href="#"><u>Hugh Barrass</u></a>	Editor – Clauses 30, 45
<a href="#"><u>Jonathan King</u></a>	Editor – Clause 87
<a href="#"><u>Arthur Marris</u></a>	Editor – Clauses 69, 73, 74, 84, Annexes 69A, 69B
<a href="#"><u>Steve Trowbridge</u></a>	Editor – Clause 83, Annex 83C
<a href="#"><u>Ryan Latchman</u></a>	Editor – Annex 83A, 83B
<a href="#"><u>Piers Dawe</u></a>	Editor – Clause 86, 52
<a href="#"><u>George Oulundsen</u></a>	Task Force Secretary
<a href="#"><u>Frank Chang</u></a>	Task Force Web Master

# Ground Rules

- Based upon IEEE 802.3 Rules
  - Foundation based upon Robert's Rules of Order
  - Anyone in the room may speak
  - Anyone in the room may vote
- **RESPECT**... give it, get it
- NO product pitches
- NO corporate pitches
- NO prices!!!
  - This includes costs, ASPs, etc. no matter what the currency
- NO restrictive notices

# Reflector and Web

- To subscribe to the IEEE P802.3ba Task Force reflector, send an email to:

***ListServ@ieee.org***

with the following in the body of the message (do not include “<>”):

***subscribe stds-802-3-hssg <yourfirstname> <yourlastname>  
end***

- Send IEEE P802.3ba Task Force reflector messages to:

***STDS-802-3-HSSG@listserv.ieee.org***

- Task Force web page URL:

***http://www.ieee802.org/3/ba/***

# IEEE P802.3ba Private Area

- URL: <http://www.ieee802.org/3/ba/private/>
  - Username: 802.3ba
  - Password: xxxxxxxx
- Write it down...
- Note - The draft is posted for your review only, and neither the draft nor access information should be copied or redistributed to others in violation of document copyrights.



# Task Force Approved Project Documents

## ■ PAR

- [http://ieee802.org/3/ba/PAR/par\\_0308.pdf](http://ieee802.org/3/ba/PAR/par_0308.pdf)

## ■ 5 Criteria

- [http://ieee802.org/3/ba/PAR/P802.3ba\\_5C\\_0908.pdf](http://ieee802.org/3/ba/PAR/P802.3ba_5C_0908.pdf)

## ■ Objectives

- [http://ieee802.org/3/ba/PAR/P802.3ba\\_Objectives\\_0709.pdf](http://ieee802.org/3/ba/PAR/P802.3ba_Objectives_0709.pdf)

# IEEE Structure

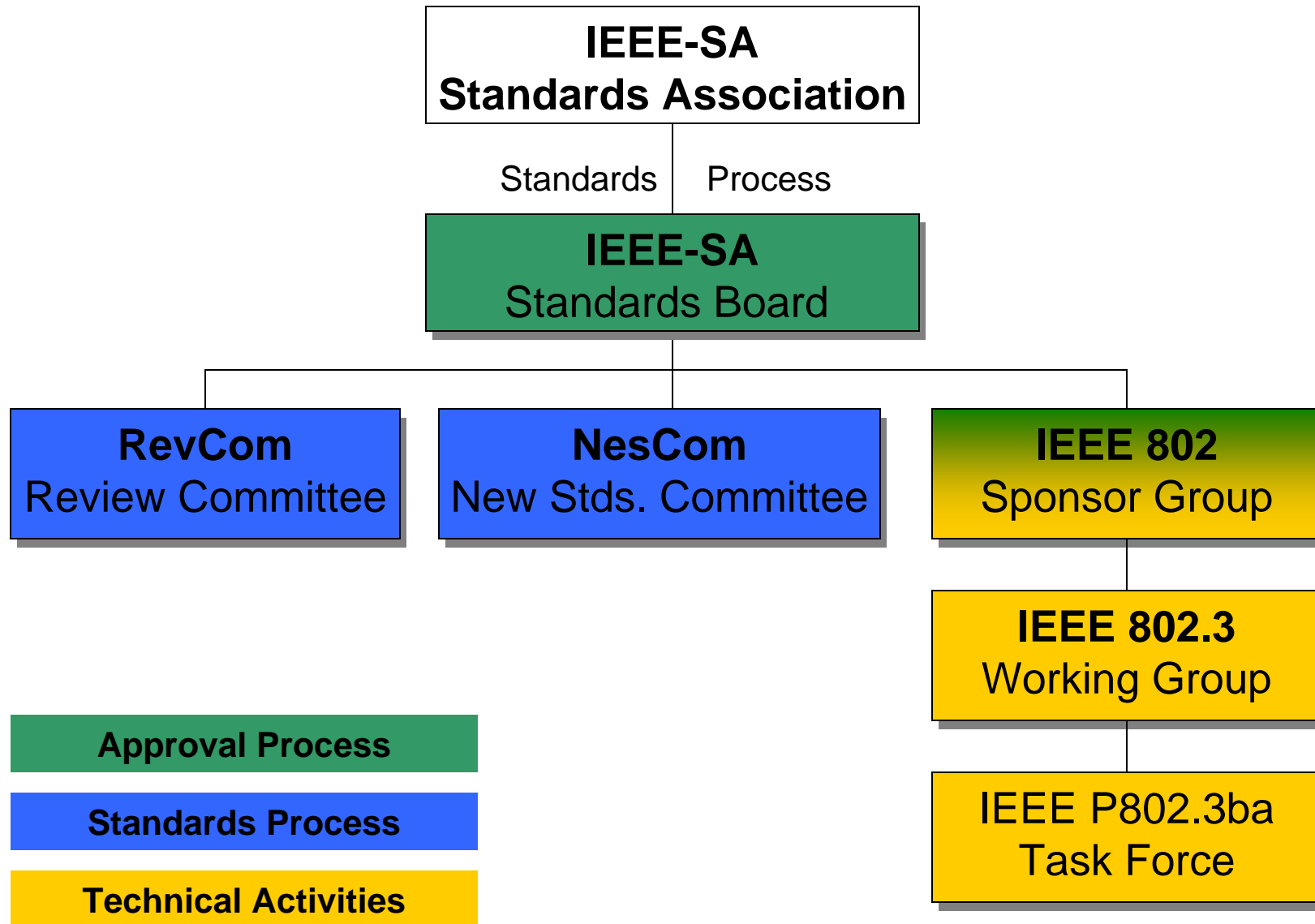

# Bylaws and Rules

- **IEEE-SA Operations Manual:**
  - <http://standards.ieee.org/sa/sa-om.pdf>
- **IEEE-SA Standards Board Bylaws:**
  - <http://standards.ieee.org/guides/bylaws/sb-bylaws.pdf>
- **IEEE-SA Standards Board Operations Manual:**
  - <http://standards.ieee.org/guides/opman/sb-om.pdf>
- **IEEE 802 LAN/MAN Standards Committee (LMSC) Policies and Procedures:**
  - [http://standards.ieee.org/board/aud/LMSC\\_2009.pdf](http://standards.ieee.org/board/aud/LMSC_2009.pdf)
- **IEEE 802 LAN/MAN Standards Committee (LMSC) Operations Manual:**
  - [http://www.ieee802.org/PNP/2009-11/LMSC OM approved 091120 rev 100213.pdf](http://www.ieee802.org/PNP/2009-11/LMSC_OM_approved_091120_rev_100213.pdf)
- **IEEE 802 LAN/MAN Standards Committee (LMSC) Working Group (WG) Policies and Procedures:**
  - [http://www.ieee802.org/PNP/2009-11/LMSC WG PandP approved 091120 rev 100213.pdf](http://www.ieee802.org/PNP/2009-11/LMSC_WG_PandP_approved_091120_rev_100213.pdf)
- **IEEE 802.3 Working Group Operating Rules:**
  - [http://ieee802.org/3/rules/P802\\_3\\_rules.pdf](http://ieee802.org/3/rules/P802_3_rules.pdf)

# Participants, Patents, and Duty to Inform

All participants in this meeting have certain obligations under the IEEE-SA Patent Policy. Participants:

- ❑ “Shall inform the IEEE (or cause the IEEE to be informed)” of the identity of each “holder of any potential Essential Patent Claims of which they are personally aware” if the claims are owned or controlled by the participant or the entity the participant is from, employed by, or otherwise represents
  - “Personal awareness” means that the participant “is personally aware that the holder may have a potential Essential Patent Claim,” even if the participant is not personally aware of the specific patents or patent claims
- ❑ “Should inform the IEEE (or cause the IEEE to be informed)” of the identity of “any other holders of such potential Essential Patent Claims” (that is, third parties that are not affiliated with the participant, with the participant’s employer, or with anyone else that the participant is from or otherwise represents)
- ❑ The above does not apply if the patent claim is already the subject of an Accepted Letter of Assurance that applies to the proposed standard(s) under consideration by this group

Quoted text excerpted from IEEE-SA Standards Board Bylaws subclause 6.2

- Early identification of holders of potential Essential Patent Claims is strongly encouraged
- No duty to perform a patent search

# Patent Related Links

All participants should be familiar with their obligations under the IEEE-SA Policies & Procedures for standards development.

Patent Policy is stated in these sources:

IEEE-SA Standards Boards Bylaws

<http://standards.ieee.org/guides/bylaws/sect6-7.html#6>

IEEE-SA Standards Board Operations Manual

<http://standards.ieee.org/guides/opman/sect6.html#6.3>

Material about the patent policy is available at

<http://standards.ieee.org/board/pat/pat-material.html>

If you have questions, contact the IEEE-SA Standards Board Patent Committee Administrator at [patcom@ieee.org](mailto:patcom@ieee.org) or visit <http://standards.ieee.org/board/pat/index.html>

This slide set is available at <http://standards.ieee.org/board/pat/pat-slideset.ppt>

# Call for Potentially Essential Patents

- If anyone in this meeting is personally aware of the holder of any patent claims that are potentially essential to implementation of the proposed standard(s) under consideration by this group and that are not already the subject of an Accepted Letter of Assurance:
  - Either speak up now or
  - Provide the chair of this group with the identity of the holder(s) of any and all such claims as soon as possible or
  - Cause an LOA to be submitted

# Other Guidelines for IEEE WG Meetings

- **All IEEE-SA standards meetings shall be conducted in compliance with all applicable laws, including antitrust and competition laws.**
  - **Don't discuss the interpretation, validity, or essentiality of patents/patent claims.**
  - **Don't discuss specific license rates, terms, or conditions.**
    - Relative costs, including licensing costs of essential patent claims, of different technical approaches may be discussed in standards development meetings.
      - Technical considerations remain primary focus
  - **Don't discuss or engage in the fixing of product prices, allocation of customers, or division of sales markets.**
  - **Don't discuss the status or substance of ongoing or threatened litigation.**
  - **Don't be silent if inappropriate topics are discussed ... do formally object.**

-----  
See *IEEE-SA Standards Board Operations Manual*, clause 5.3.10 and "Promoting Competition and Innovation: What You Need to Know about the IEEE Standards Association's Antitrust and Competition Policy" for more details.

# Overview of IEEE 802.3 Standards Process (1/5)- Study Group Phase

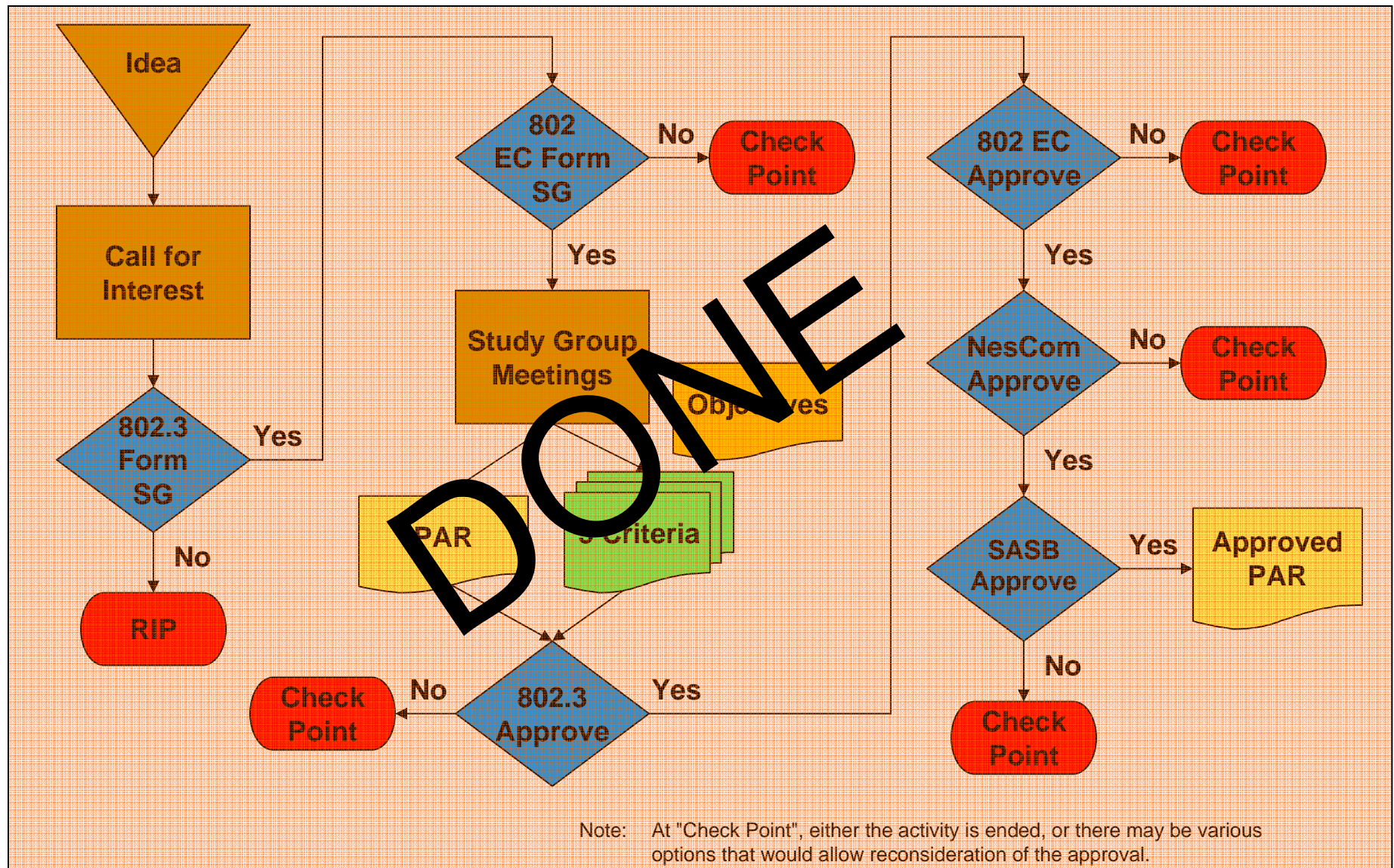



# Overview of IEEE 802.3 Standards Process (2/5) - Task Force Comment Phase

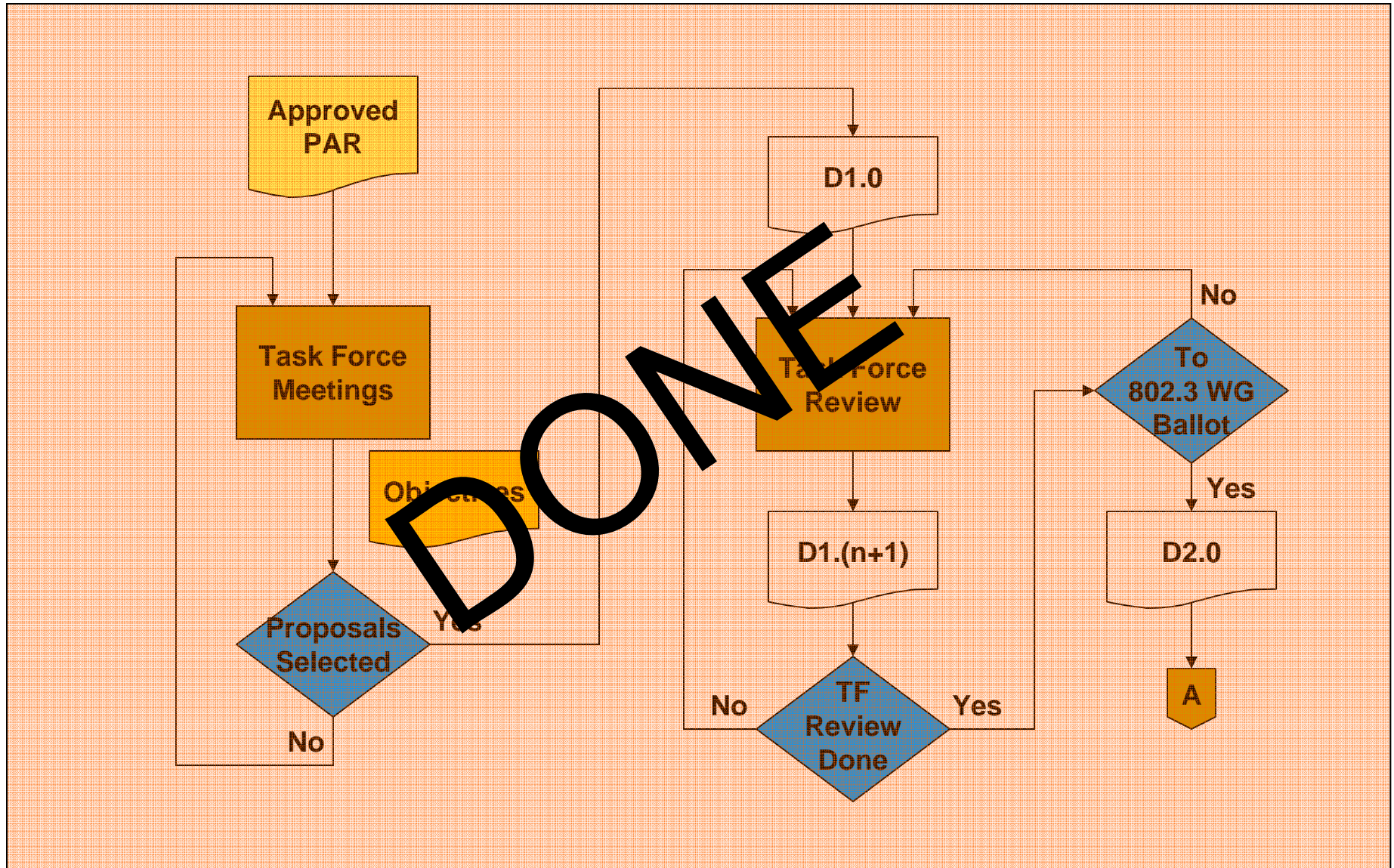

# Overview of IEEE 802.3 Standards Process (3/5) - Working Group Ballot Phase

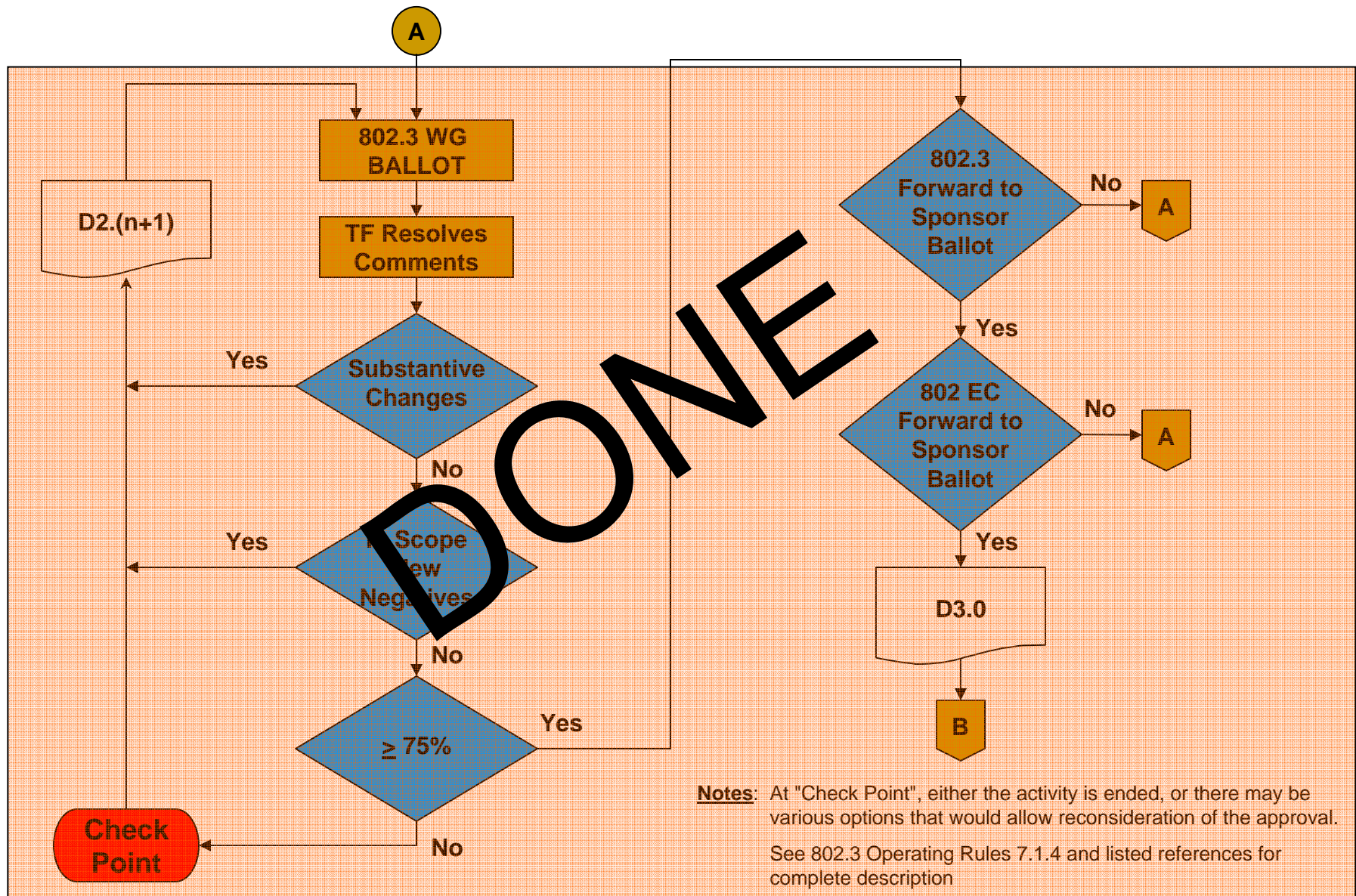

# Overview of IEEE 802.3 Standards Process (4/5)- Sponsor Ballot Phase

## WE ARE HERE

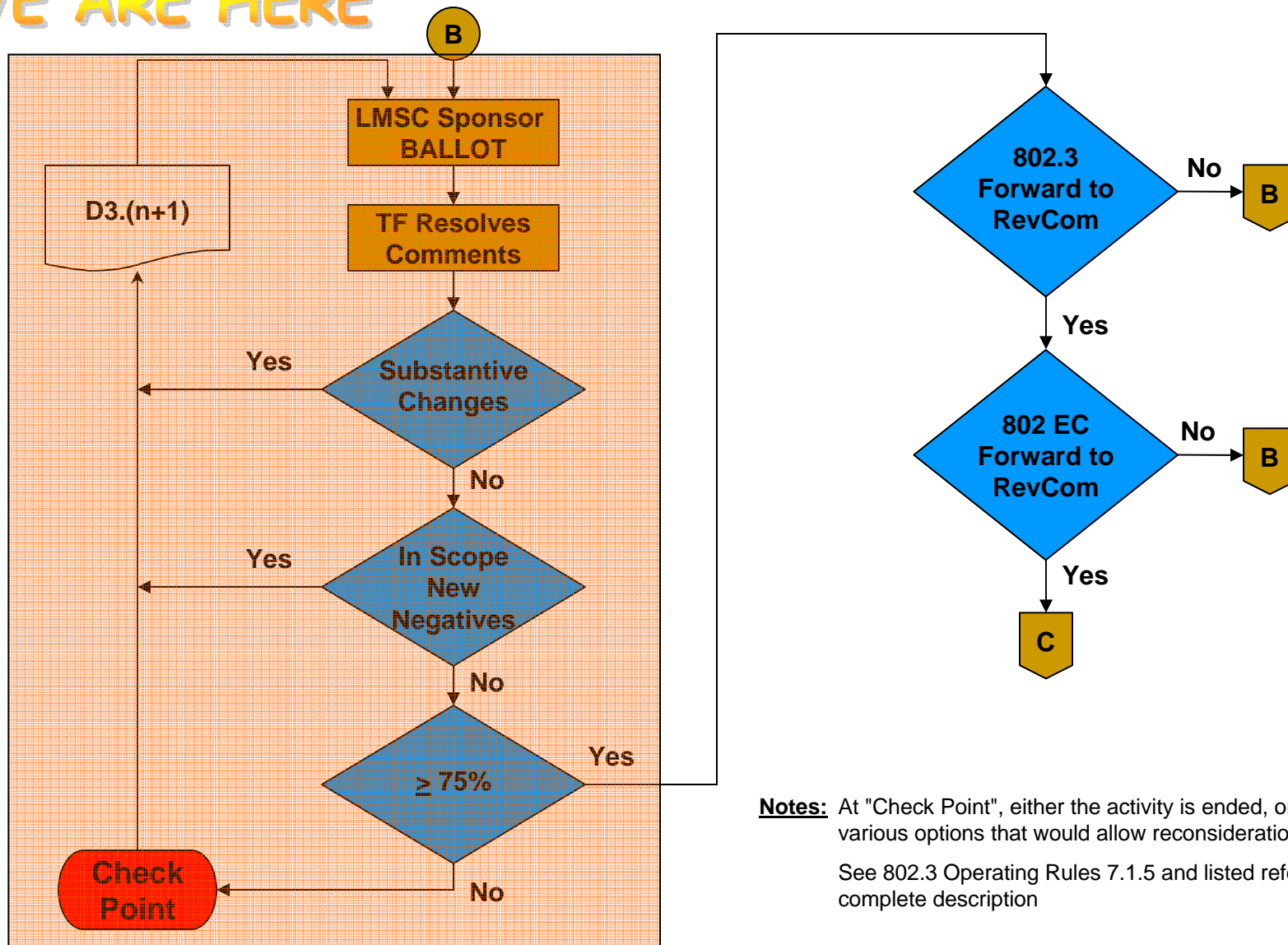

**Notes:** At "Check Point", either the activity is ended, or there may be various options that would allow reconsideration of the approval. See 802.3 Operating Rules 7.1.5 and listed references for complete description

# Overview of IEEE 802.3 Standards Process (5/5) - Final Approvals / Standard Release

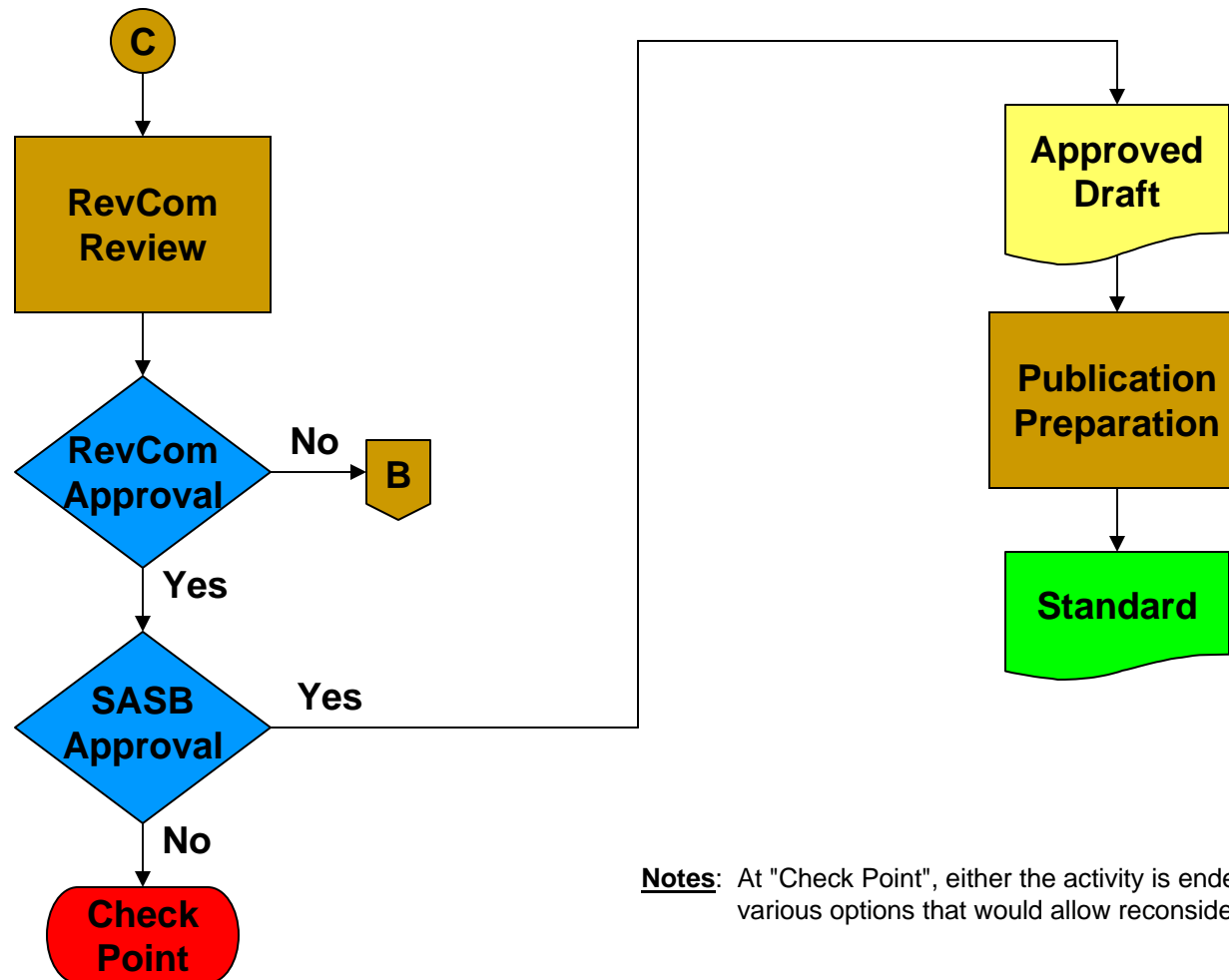

**Notes:** At "Check Point", either the activity is ended, or there may be various options that would allow reconsideration of the approval.

# Per IEEE-SA Standards Board Operations Manual

## 5.4.3.5 Completion of the standards balloting process and submittal to RevCom

A minimum of 75% of those voting *Approve* or *Do Not Approve (Negative with comment)* must approve the draft in order to submit the ballot result to the IEEE-SA Standards Board. In the event that 30% or more of the returned ballots are *Abstentions*, the standards balloting process shall be considered invalid.

In the event that a 75% return cannot be obtained, the standards balloting process is considered to have failed and further disposition of the proposed standard shall be the responsibility of the Sponsor.

Once all required recirculations have been completed and 75% approval has been achieved, the IEEE requirements for consensus have been met. Efforts to resolve *Do Not Approve* votes may continue for a brief period; however, if such resolution is not possible in a timely manner, the Sponsor should forward the submittal to RevCom because the IEEE has an obligation to the majority to review and publish the proposed standard quickly.

Copies of all unresolved *Do Not Approve* votes, together with the reasons given by the *Do Not Approve* voters and the responses by the Sponsor, shall be included with the ballot results submitted to RevCom.

The Sponsor shall, if not included in a recirculation package, provide to the *Do Not Approve* voter and to RevCom an explanation why any comments associated with a *Do Not Approve* vote were not required to be recirculated. In order for a *Do Not Approve* vote to be changed to an *Approve* or *Abstain* vote, the Sponsor shall obtain and provide to RevCom written confirmation from each voter (by letter, fax, or electronic mail) that indicates concurrence with any change of his or her vote. Any *Do Not Approve* vote with comment that RevCom is asked to consider as a *Do Not Approve (Negative without comment)* shall be explained to RevCom.

Proposed standards receiving a significant number of unresolved *Do Not Approve* votes should be considered by the Sponsor for trial-use (see [5.7](#)).

# IEEE P802.3ba Task Force Timeline

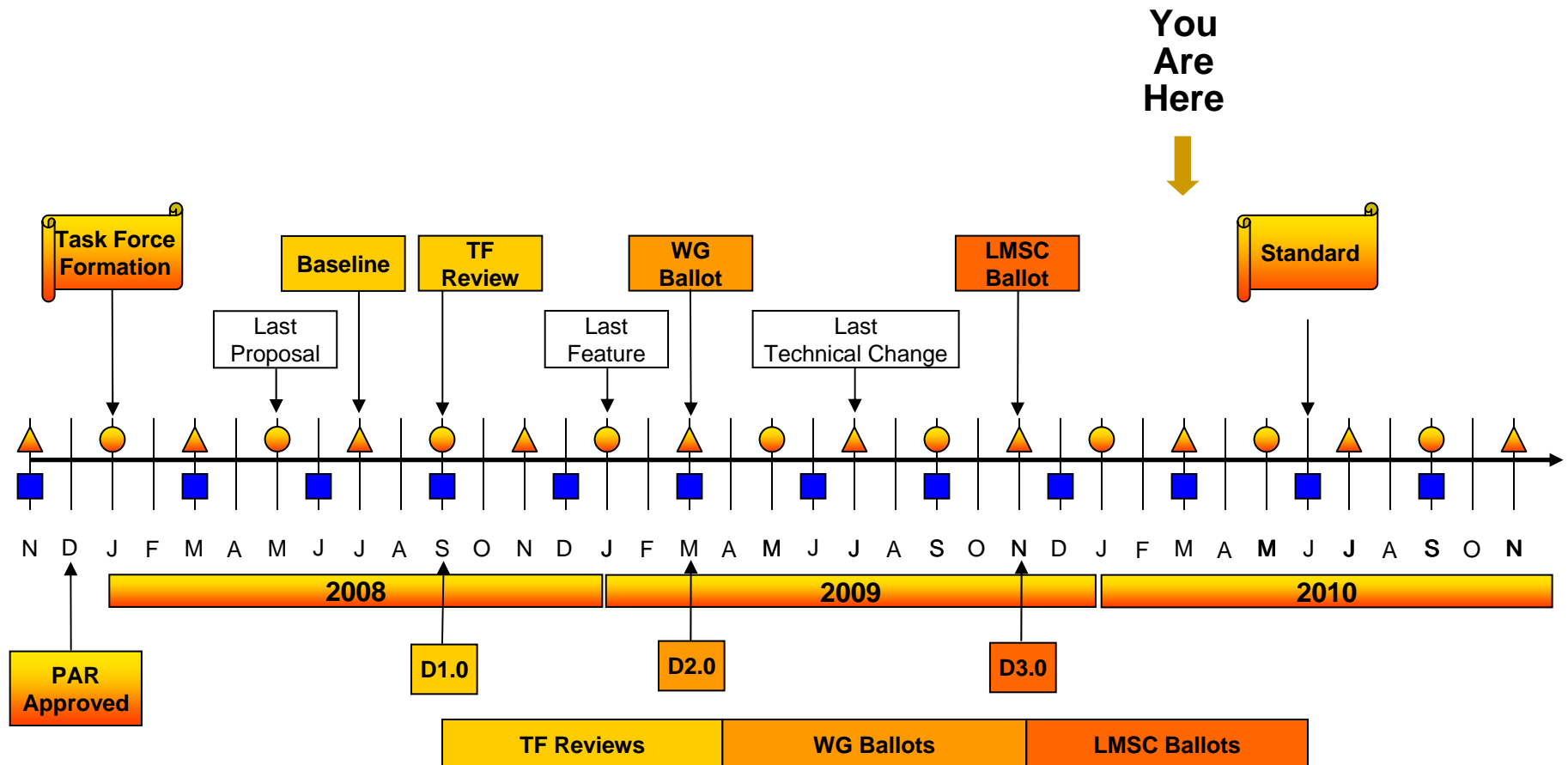

\* Adopted by IEEE P802.3ba TF at March 08 Plenary

Legend	
▲	IEEE 802 Plenary
●	IEEE 802.3 Interim
■	IEEE-SA Standards Board

# Meeting Map

	Mon	Tues	Wed	Thur	Fri		
8:30		Task Force	Logic	Copper	Optics	Task Force Motions & Closing Business	
9:00							
9:30							
10:00							
10:30							
11:00							
11:30							
12:00	Lunch	Lunch	Lunch		Lunch		
12:30							
13:00	802.3 Plenary	Task Force	Logic	Copper	Optics	802.3 Plenary	
13:30							
14:00							
14:30							
15:00							
15:30							
16:00		Logic	Copper	Optics		SEC	
16:30							
17:00							
17:30							
18:00		Dinner					
18:30	Tutorial #1		Social				
19:00		IEEE 802 30th Anniversary Celebration - Panel Discussion					
19:30	Tutorial #2						
20:00							
20:30							
21:00							
21:30	CFI						
22:00							

Note –Times listed are subject to change. See individual sub-task force agendas for sub-task force meeting details.

Tuesday 16-Mar-10

Time	Presenter	Affiliation	Title	File Name
8:30 AM	John D'Ambrosia	Force10 Networks	Agenda and General Information	agenda_01_0310.pdf
9:00 AM	Ilango Ganga	Intel	Chief Editor's Opening Report	ganga_01_0310.pdf
9:30 AM	Mark Gustlin	Cisco	Logic SubTask Force - Opening Report	gustlin_01_0310.pdf
9:40 AM	Chris DiMinico	MC Communications	Cu SubTask Force - Opening Report	diminico_01_0310.pdf
9:50 AM	Pete Anslow	Nortel	Optical SubTask Force - Opening Report	anslow_01_0310.pdf
10:00 AM			Break	
10:15 AM	Steve Trowbridge	Alcatel-Lucent	Liaison Letter from OIF	0310_OIF_to_802_3.pdf
10:25 AM	Alan Flatman	LAN Technologies	Liaison Report from ISO/IEC JTC 1/SC 25/WG 3 to IEEE 802.3	ISO_IEC_WG3_to_802_3_3N926.pdf
10:35 AM	Terry Cobb	Systimax	INCITS T11.2 Liaison Report 802.3	0310_T11_2.pdf
10:45 AM			Task Force Comment Resolution	anslow_04_0310.pdf
12:00 PM			Dinner	
1:15 PM			Task Force Comment Resolution	
3:00 PM			Break	
3:30 PM			Sub-Task Force Meetings	
6:00 PM			Break for Day	

Thursday 18-Mar-10

Time	Presenter	Affiliation	Title	File Name
8:30 AM	John D'Ambrosia	Force10 Networks	Opening Comments	
8:45 AM	Mark Gustlin	Cisco	Logic Sub Task Force - Closing Report	gustlin_03_0310.pdf
9:00 AM	Chris DiMinico	MC Communications	Cu SubTask Force - Closing Report	diminico_03_0310.pdf
9:15 AM	Pete Anslow	Nortel	Optical SubTask Force - Closing Report	anslow_03_0310.pdf
9:30 AM	Ilango Ganga	Intel	Chief Editor's Closing Report	ganga_02_0310.pdf
9:30 AM			Break	
10:00 AM			Discussion, Motions, & Closing Business	
Noon			Adjourn	

Note – Order of presentations and times listed are subject to change.



# Future Meetings

- Future Meeting information at:
  - <http://ieee802.org/3/interims/index.html>
- Tentative - April 2010 IEEE 802.3ba Interim
  - April 20
  - Location – San Jose / San Francisco, Ca, USA
- May 2010 IEEE 802.3 Interim
  - May 24 - 28
  - Geneva, Switzerland



Thank You!

