



# IEEE P802.3ba 40Gb/s and 100Gb/s Ethernet Task Force

## Agenda and General Information

Dallas, Tx  
November, 2008



# Agenda

- Welcome and Introductions
- Approve Agenda
- Approve the Minutes
- Goals for this Week
- Ground Rules
- Reflector and Web
- IEEE
  - Structure
  - Bylaws and Rules
  - Call for Patents
  - IEEE Standards Process
- Chief Editor's Report
- Liaison's
- Ad Hoc Reports
- Review D1.0 (Sub-Task Force Reviews)
- Sub-Task Force Closing Reports
- Motions & Closing Business
- Future Meetings

# Goals for the Week

- Progress Towards Generating Draft 1.1
  - Comment Resolution of Draft 1.0
- Lay groundwork for the next meeting

# IEEE P802.3ba Task Force Officers and Editors

<a href="#"><u>John D'Ambrosia</u></a>	Task Force Chair
<a href="#"><u>Ilango Ganga</u></a>	Task Force Chief Editor Editor – Clauses 1, 4, 80, Annexes A, 4A
<a href="#"><u>Mark Gustlin</u></a>	Chair, “Logic” Sub-task Force Editor – Clauses 81, 82
<a href="#"><u>Chris DiMinico</u></a>	Chair, “Cu” Sub-task Force Editor – Clause 85
<a href="#"><u>Pete Anslow</u></a>	Chair, “Optical” Sub-task Force Editor – Clause 88
<a href="#"><u>Hugh Barrass</u></a>	Editor – Clauses 30, 45, Annexes 30A, 30B
<a href="#"><u>Jonathan King</u></a>	Editor – Clause 87
<a href="#"><u>Arthur Marris</u></a>	Editor – Clauses 69, 73, 74, 84, Annexes 69A, 69B
<a href="#"><u>Steve Trowbridge</u></a>	Editor – Clause 83
<a href="#"><u>Ryan Latchman</u></a>	Editor – Annex 83A Chair, “nAUI” Ad Hoc
<a href="#"><u>Piers Dawe</u></a>	Editor – Clause 86 Chair – “Statistical Eye” Ad Hoc
<a href="#"><u>Alessandro Barbieri</u></a>	Co-chair – Extended Reach Parallel MMF Ad Hoc
<a href="#"><u>John Petrilla</u></a>	Co-chair - Extended Reach Parallel MMF Ad Hoc
<a href="#"><u>George Oulundsen</u></a>	Task Force Secretary
<a href="#"><u>Frank Chang</u></a>	Task Force Web Master

# Ground Rules

- Based upon IEEE 802.3 Rules
  - Foundation based upon Robert's Rules of Order
  - Anyone in the room may speak
  - Anyone in the room may vote
- **RESPECT**... give it, get it
- NO product pitches
- NO corporate pitches
- NO prices!!!
  - This includes costs, ASPs, etc. no matter what the currency
- NO restrictive notices

# Reflector and Web

- To subscribe to the IEEE P802.3ba Task Force reflector, send an email to:

***ListServ@ieee.org***

with the following in the body of the message (do not include “<>”):

***subscribe stds-802-3-hssg <yourfirstname> <yourlastname>  
end***

- Send IEEE P802.3ba Task Force reflector messages to:

***STDS-802-3-HSSG@listserv.ieee.org***

- Task Force web page URL:

***http://www.ieee802.org/3/ba/***

# Task Force Decorum



- Press (i.e., anyone reporting publicly on this meeting) are to announce their presence (2007 SASB Op Manual 5.3.3.5)
- Photography or recording by permission only (5.3.3.4)
- Cell phone ringers off
- Wear your badges at all times in meeting areas

# IEEE P802.3ba Private Area

- URL: <http://www.ieee802.org/3/ba/private/>
  - Username: 802.3ba
  - Password: xxxxxxx
- Write it down...



# Task Force Approved Project Documents

## ■ PAR

- [http://ieee802.org/3/ba/PAR/par\\_0308.pdf](http://ieee802.org/3/ba/PAR/par_0308.pdf)

## ■ 5 Criteria

- [http://ieee802.org/3/ba/PAR/P802.3ba\\_5C\\_0908.pdf](http://ieee802.org/3/ba/PAR/P802.3ba_5C_0908.pdf)

## ■ Objectives

- [http://ieee802.org/3/ba/PAR/P802.3ba\\_Objectives\\_0308.pdf](http://ieee802.org/3/ba/PAR/P802.3ba_Objectives_0308.pdf)

# Task Force Objectives

- Support full-duplex operation only
- Preserve the 802.3 / Ethernet frame format utilizing the 802.3 MAC
- Preserve minimum and maximum FrameSize of current 802.3 standard
- Support a BER better than or equal to  $10^{-12}$  at the MAC/PLS service interface
- Provide appropriate support for OTN
- Support a MAC data rate of 40 Gb/s
- Provide Physical Layer specifications which support 40 Gb/s operation over:
  - at least 10km on SMF
  - at least 100m on OM3 MMF
  - at least 10m over a copper cable assembly
  - at least 1m over a backplane
- Support a MAC data rate of 100 Gb/s
- Provide Physical Layer specifications which support 100 Gb/s operation over:
  - at least 40km on SMF
  - at least 10km on SMF
  - at least 100m on OM3 MMF
  - at least 10m over a copper cable assembly

Adopted by IEEE P802.3ba and approved by 802.3 at Mar 2008 Plenary

# IEEE Structure

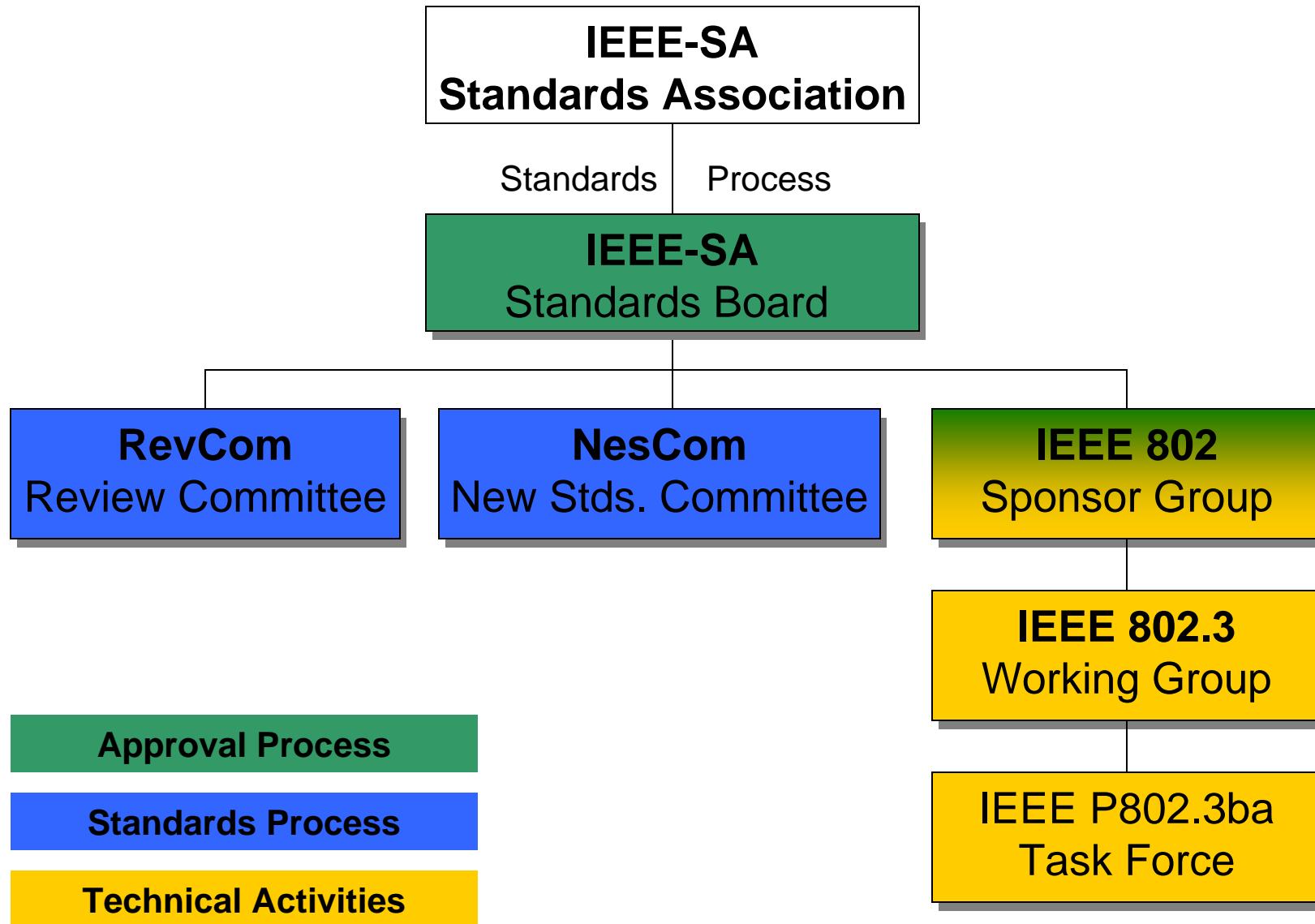

# Bylaws and Rules

- IEEE-SA Operations Manual:
  - <http://standards.ieee.org/sa/sa-om.pdf>
- IEEE-SA Standards Board Bylaws:
  - <http://standards.ieee.org/guides/bylaws/sb-bylaws.pdf>
- IEEE-SA Standards Board Operations Manual:
  - <http://standards.ieee.org/guides/opman/sb-om.pdf>
- LAN/MAN Standards Committee (LMSC) Policies and Procedures:
  - <http://ieee802.org/policies-and-procedures.pdf>
- IEEE 802.3 Working Group Operating Rules:
  - [http://ieee802.org/3/rules/P802\\_3\\_rules.pdf](http://ieee802.org/3/rules/P802_3_rules.pdf)

# Participants, Patents, and Duty to Inform

All participants in this meeting have certain obligations under the IEEE-SA Patent Policy. Participants:

- **“Shall inform the IEEE (or cause the IEEE to be informed)” of the identity of each “holder of any potential Essential Patent Claims of which they are personally aware” if the claims are owned or controlled by the participant or the entity the participant is from, employed by, or otherwise represents**
  - **“Personal awareness” means that the participant “is personally aware that the holder may have a potential Essential Patent Claim,” even if the participant is not personally aware of the specific patents or patent claims**
- **“Should inform the IEEE (or cause the IEEE to be informed)” of the identity of “any other holders of such potential Essential Patent Claims” (that is, third parties that are not affiliated with the participant, with the participant’s employer, or with anyone else that the participant is from or otherwise represents)**
- **The above does not apply if the patent claim is already the subject of an Accepted Letter of Assurance that applies to the proposed standard(s) under consideration by this group**

Quoted text excerpted from IEEE-SA Standards Board Bylaws subclause 6.2

- **Early identification of holders of potential Essential Patent Claims is strongly encouraged**
- **No duty to perform a patent search**

# Patent Related Links

All participants should be familiar with their obligations under the IEEE-SA Policies & Procedures for standards development.

Patent Policy is stated in these sources:

IEEE-SA Standards Boards Bylaws

<http://standards.ieee.org/guides/bylaws/sect6-7.html#6>

IEEE-SA Standards Board Operations Manual

<http://standards.ieee.org/guides/opman/sect6.html#6.3>

Material about the patent policy is available at

<http://standards.ieee.org/board/pat/pat-material.html>

If you have questions, contact the IEEE-SA Standards Board Patent Committee Administrator at [patcom@ieee.org](mailto:patcom@ieee.org) or visit <http://standards.ieee.org/board/pat/index.html>

This slide set is available at <http://standards.ieee.org/board/pat/pat-slideset.ppt>

# Call for Potentially Essential Patents

- If anyone in this meeting is personally aware of the holder of any patent claims that are potentially essential to implementation of the proposed standard(s) under consideration by this group and that are not already the subject of an Accepted Letter of Assurance:
  - Either speak up now or
  - Provide the chair of this group with the identity of the holder(s) of any and all such claims as soon as possible or
  - Cause an LOA to be submitted

# Other Guidelines for IEEE WG Meetings

- **All IEEE-SA standards meetings shall be conducted in compliance with all applicable laws, including antitrust and competition laws.**
  - **Don't discuss the interpretation, validity, or essentiality of patents/patent claims.**
  - **Don't discuss specific license rates, terms, or conditions.**
    - Relative costs, including licensing costs of essential patent claims, of different technical approaches may be discussed in standards development meetings.
      - Technical considerations remain primary focus
  - **Don't discuss or engage in the fixing of product prices, allocation of customers, or division of sales markets.**
  - **Don't discuss the status or substance of ongoing or threatened litigation.**
  - **Don't be silent if inappropriate topics are discussed ... do formally object.**

-----  
See *IEEE-SA Standards Board Operations Manual*, clause 5.3.10 and "Promoting Competition and Innovation: What You Need to Know about the IEEE Standards Association's Antitrust and Competition Policy" for more details.



# Overview of IEEE 802.3 Standards Process (1/5)- Study Group Phase

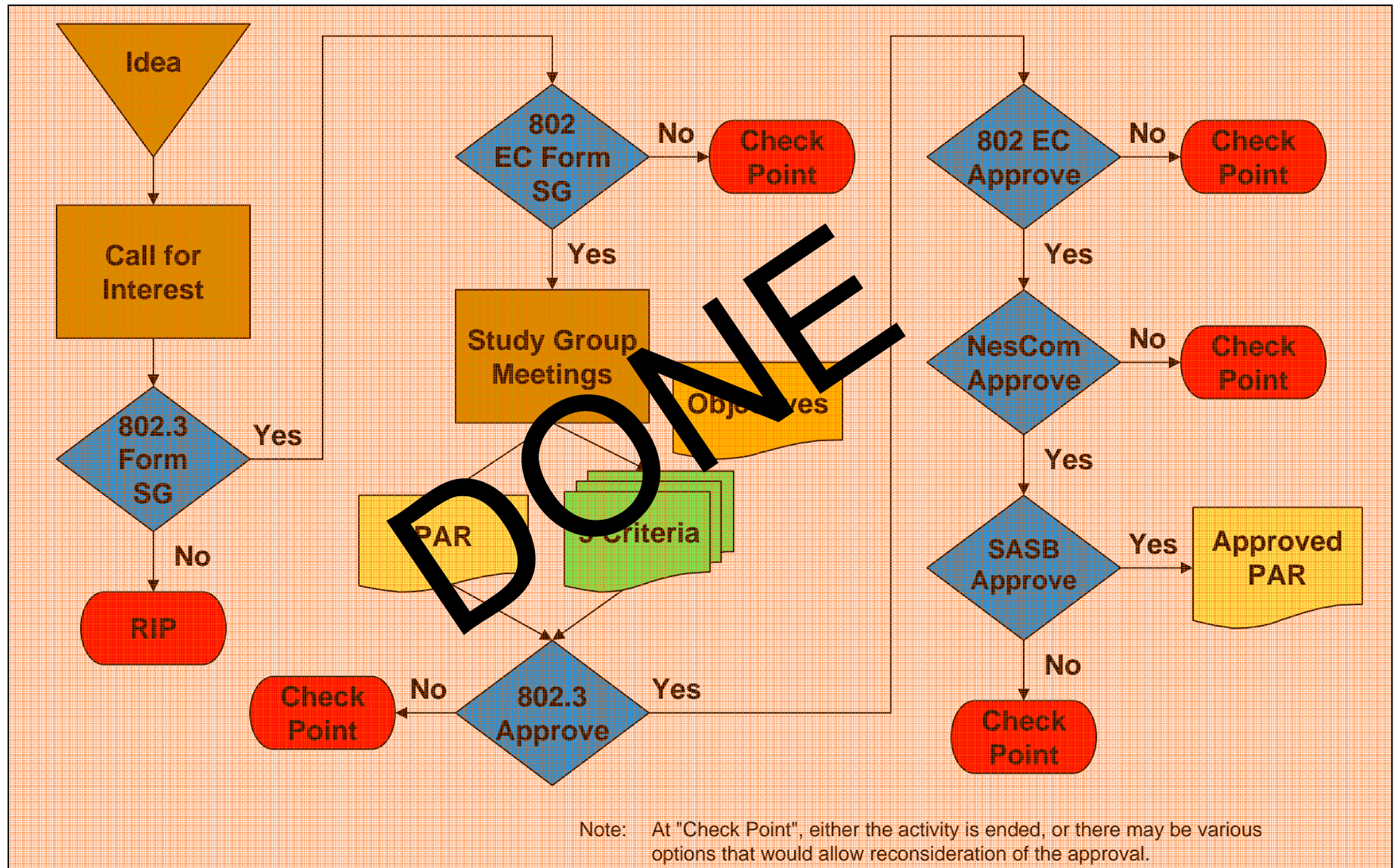

# Overview of IEEE 802.3 Standards Process (2/5) - Task Force Comment Phase

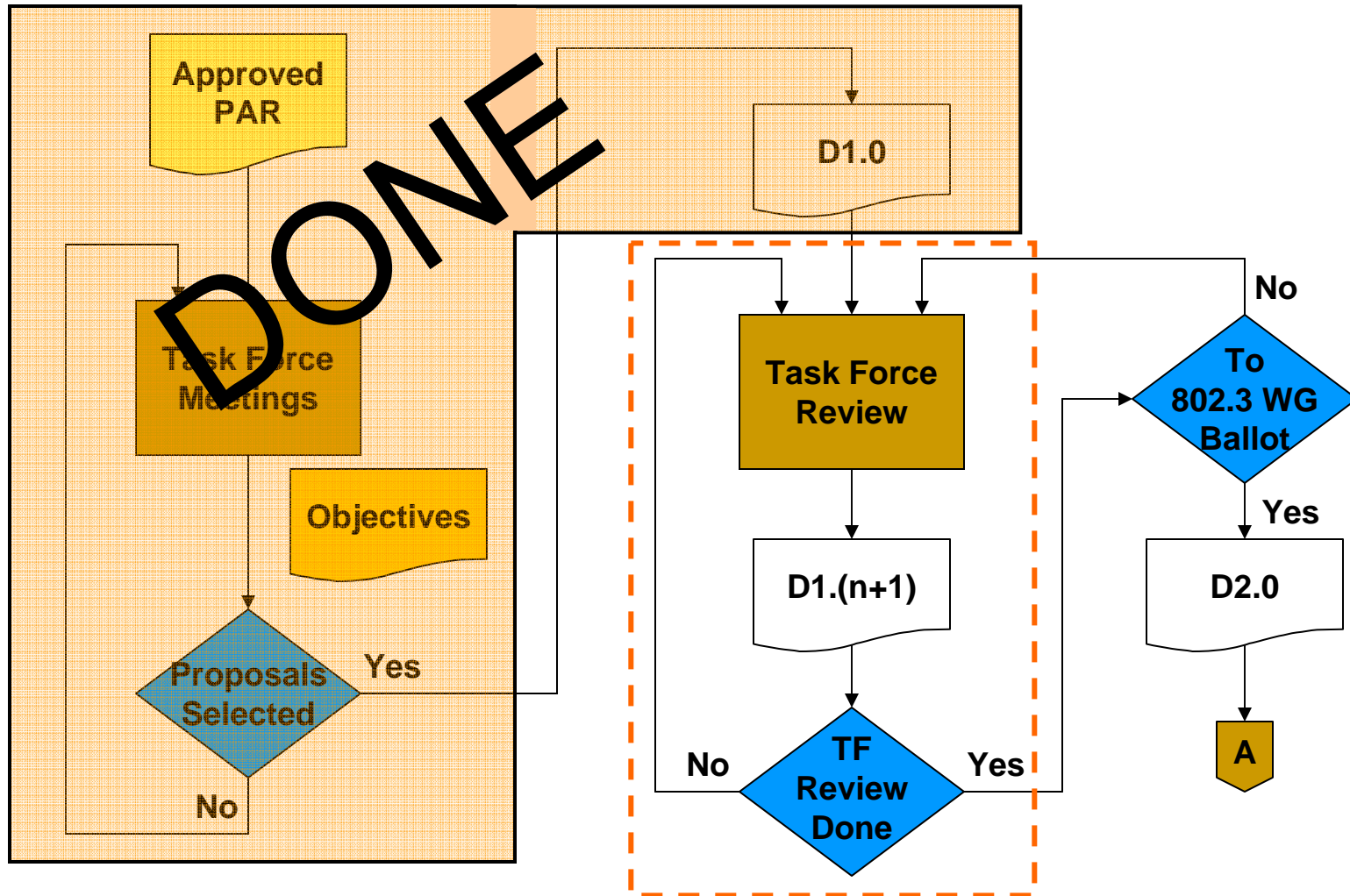

We Are Here

# Overview of IEEE 802.3 Standards Process (3/5) - Working Group Ballot Phase

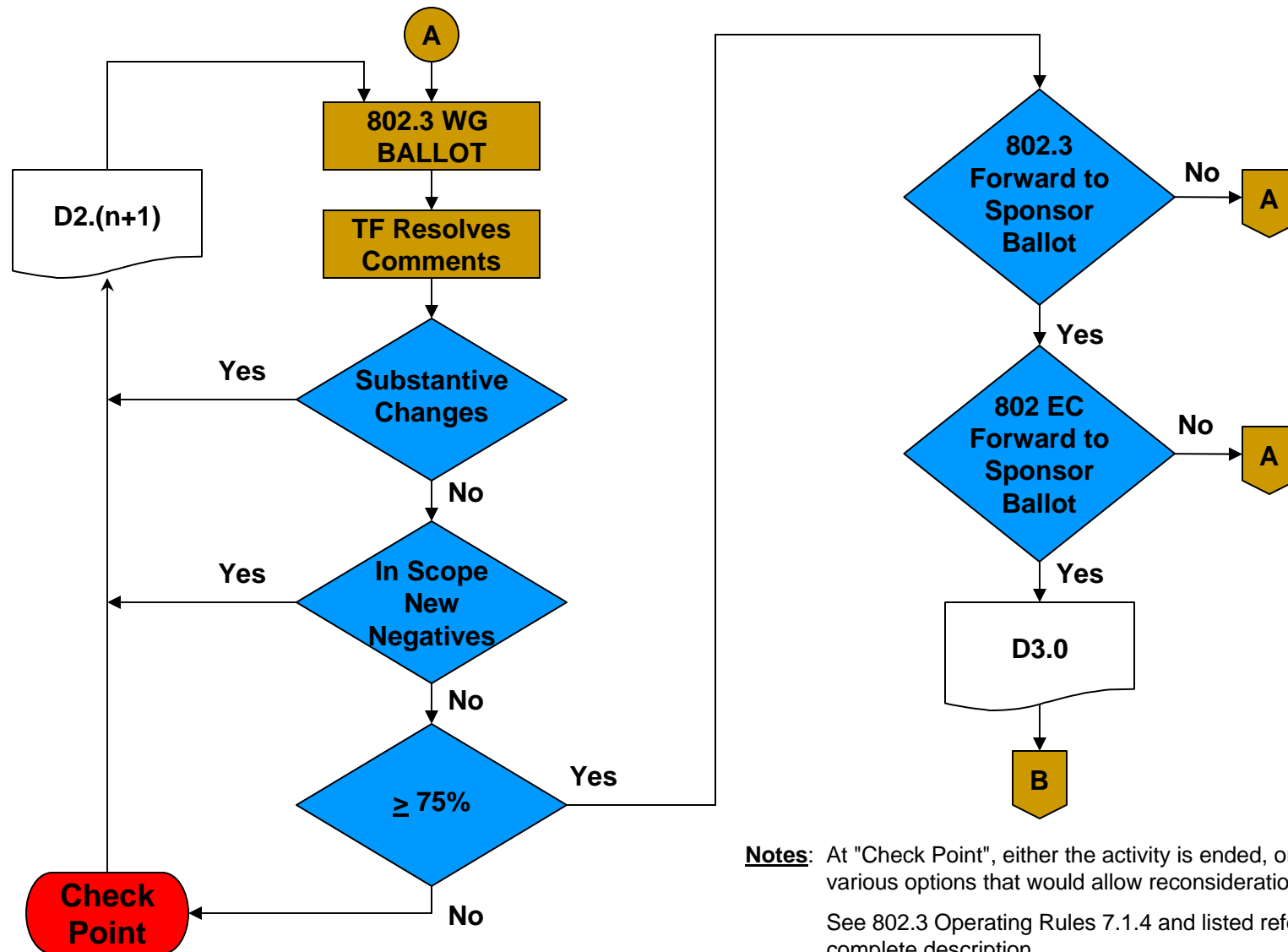

**Notes:** At "Check Point", either the activity is ended, or there may be various options that would allow reconsideration of the approval. See 802.3 Operating Rules 7.1.4 and listed references for complete description

# Overview of IEEE 802.3 Standards Process (4/5)- Sponsor Ballot Phase

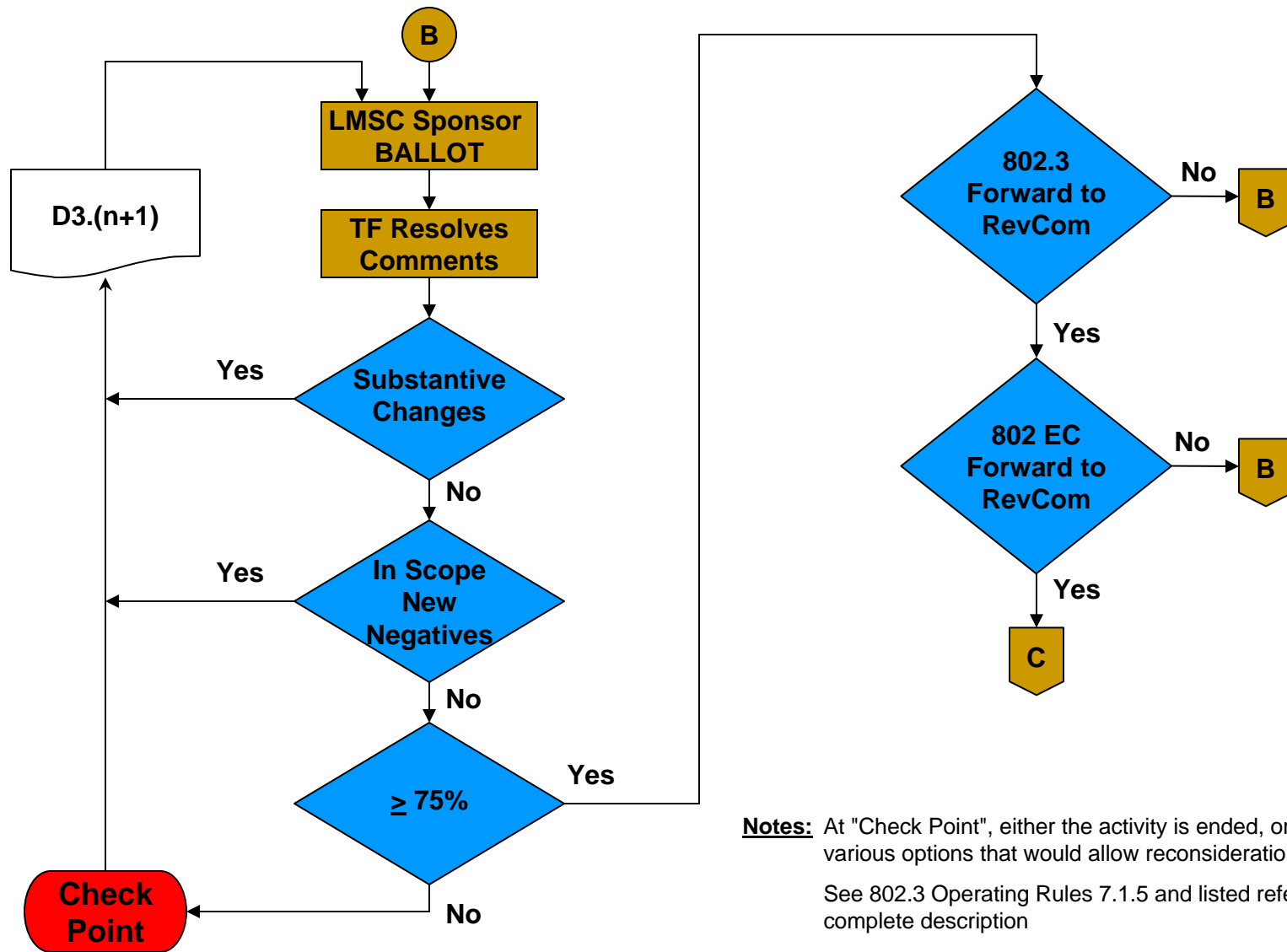

**Notes:** At "Check Point", either the activity is ended, or there may be various options that would allow reconsideration of the approval. See 802.3 Operating Rules 7.1.5 and listed references for complete description

# Overview of IEEE 802.3 Standards Process (5/5) - Final Approvals / Standard Release

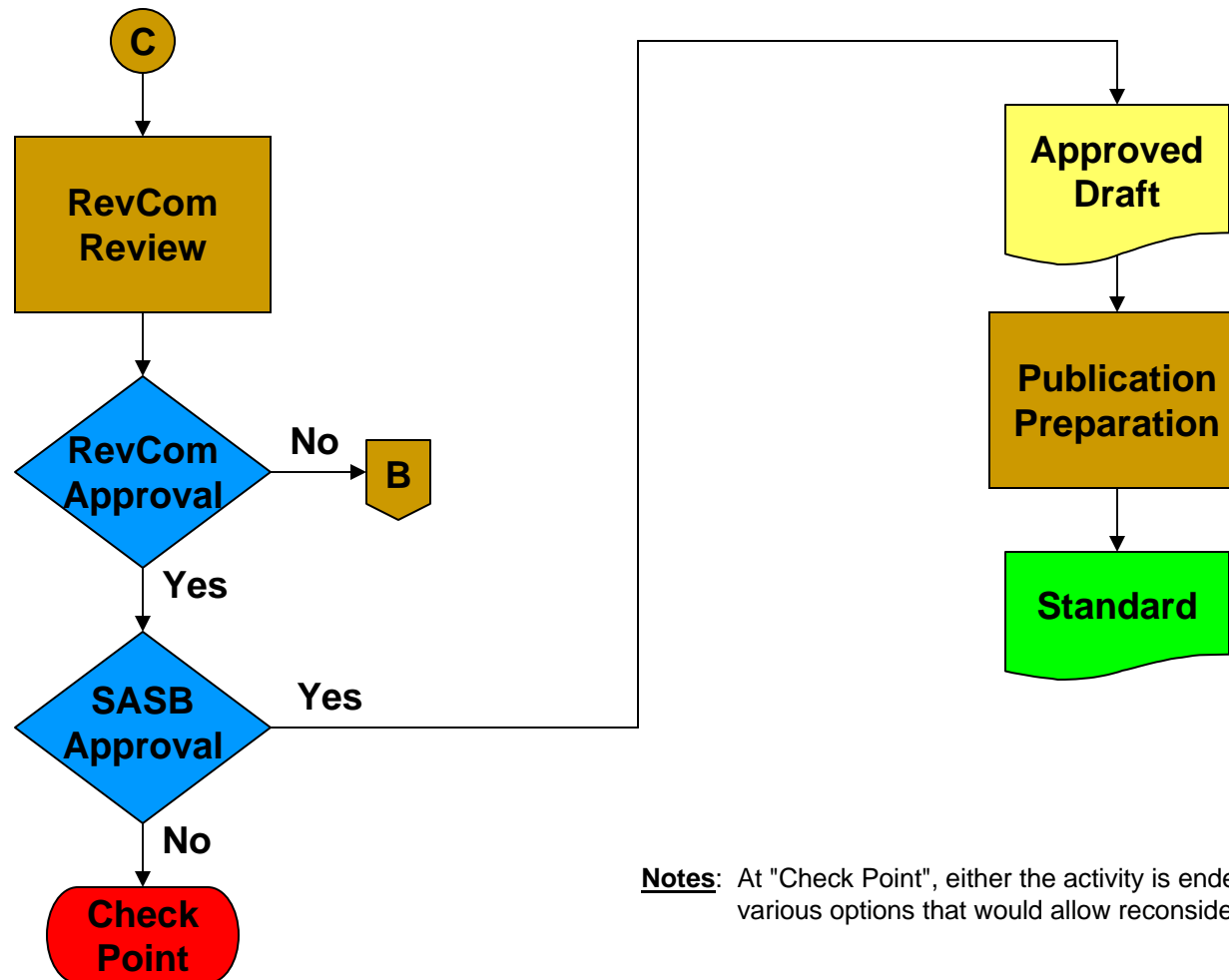

**Notes:** At "Check Point", either the activity is ended, or there may be various options that would allow reconsideration of the approval.

# IEEE P802.3ba Task Force Timeline

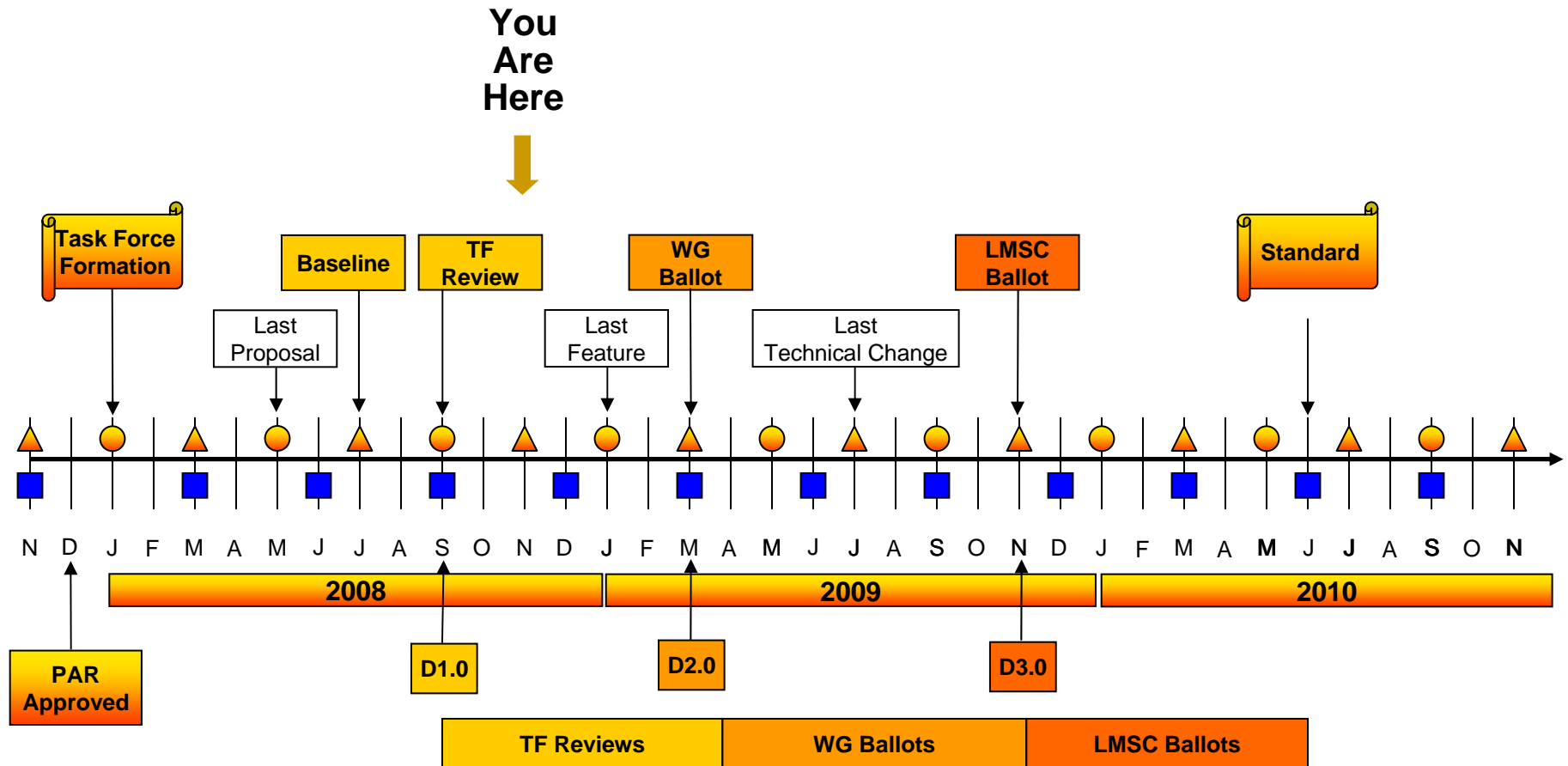

\* Adopted by IEEE P802.3ba TF at March 08 Plenary

Legend	
▲	IEEE 802 Plenary
●	IEEE 802.3 Interim
■	IEEE-SA Standards Board

# Task Force Review

- Goals for Task Force Review
  - produce a technically complete draft
  - produce a draft with no open technical issues
- What is complete?
  - All objectives are met
  - All of 5C are met
  - PAR Title, Scope, Purpose, Need are met
  - All essential requirements are definitively stated
- Goal for Task Force Review – Get to WG Ballot

# Meeting Map (1 of 2)

	Sun	Mon	Tues			
8:00		SEC	Copper (Annex 83A)			
8:30						
9:00						
9:30						
10:00						
10:30						
11:00		802.0 Plenary				
11:30						
12:00		Lunch				
12:30						
13:00	All	802.3 Plenary	Logic			
13:30				Copper	Optics	
14:00						
14:30						
15:00						
15:30						
16:00						
16:30						
17:00	Dinner					
17:30						
18:00		Dinner				
18:30	Joint Mtg of Copper and Optics	Logic	Intro Clause 80 & Mgmt			
19:00				Logic	Copper	Optics
19:30						
20:00						
20:30						



# Meeting Map (2 of 2)

	Wed	Thur	Fri	
8:00	Logic	Copper	Optics	All - Motions & Closing Business
8:30				
9:00				
9:30				
10:00				
10:30				
11:00	Logic	Copper	Optics	802.3 Plenary
11:30				
12:00				
12:30				
13:00				
13:30				
14:00	Logic	Copper	Optics	SEC
14:30				
15:00				
15:30				
16:00				
16:30				
17:00	Logic	Copper	Optics	Social
17:30				
18:00				
18:30				
19:00				
19:30				
20:00	Dinner	Dinner		
20:30				

# Further Meeting Information

- Ilango Ganga – “Intro and Management Clauses,” ganga\_02\_1108
- Mark Gustlin – “Logic Sub-task Force,” gustlin\_01\_1108
- Chris DiMinico – “Copper Sub-task Force,” diminico\_01\_1108
- Pete Anslow – “Optics Sub-task Force,” anslow\_01\_1108

# Liaisons

- ITU-T SG15, Document #COM 15-LS-02-E
- ISO/IEC JTC 1/SC 25/WG 3, Document #N 882A

# Ad Hoc Reports

- XR Ad hoc – John Petrilla / Alessandro Barbieri
- nAUI Ad hoc – Ryan Latchman

# Meeting Attendance

- The IEEE-SA Meeting Attendance Tool will be the basis of the official attendance record for this meeting
  
- To use the tool, you must have an IEEE Web Account
  - A tutorial on how to acquire an IEEE Web Account and use the Meeting Attendance Tool is available at...
  - [http://iee802.org/3/minutes/jul08/0708\\_attendance\\_tool.pdf](http://iee802.org/3/minutes/jul08/0708_attendance_tool.pdf)

# Points of emphasis

- Your login is the primary e-mail address specified in your IEEE Web Account
  - The first time you login to the system, you will be asked to create a password
  - This password only applies to this meeting week, and it does not have to be your IEEE Web Account password
  - Use the same login and password throughout the meeting week
  
- You need to login only once per meeting day
  - You are certifying that you are attending a "substantial" portion of the meeting day

# Contact information

- A participants web account information will be the official record for contact information
  - This information may be updated at any time by the participant
  - It is not subject to errors during transcription of a written record
  
- To obtain and maintain voting membership, you must maintain correct contact information in the official record

# Voting privileges

- The rules regarding obtaining and maintaining that privilege are found here:  
<http://www.ieee802.org/3/rules/member.html>
- To become a voter:
  - Complete and current contact information recorded in the Working Group 802.3 database.
  - You must attend and sign attendance book for at least 75% of sessions of two 802.3 WG plenary meetings (within the last four)
    - Full attendance at a two-day 802.3 WG Interim can be substituted for one Plenary
  - Request to become a voter during the opening or closing Plenary meeting when solicited by the Chair from the “potential voters list”
- To remain a voter
  - Maintain Complete and current contact information in the Working Group 802.3 database.
  - Have 75% attendance during at least two of the last four plenaries
    - Attendance at an interim can substitute for attendance at no more than 1 plenary
  - Participate in Working Group ballots.
    - You can be dropped for lack of participation !



# Remember to Declare Your Affiliation

- From the IEEE SA Standards Board By-laws

- **5.2.1.5 Disclosure of affiliation** (<http://standards.ieee.org/guides/bylaws/sect5.html#5.2.1.5>)

- Every member and participant in a working group, Sponsor ballot, or other standards development activity shall disclose his or her affiliation. An individual is deemed "affiliated" with any individual or entity that has been, or will be, financially or materially supporting that individual's participation in a particular IEEE standards activity. This includes, but is not limited to, his or her employer and any individual or entity that has or will have, either directly or indirectly, requested, paid for, or otherwise sponsored his or her participation. Failure to disclose every such affiliation may result in complete or partial loss of rights to participate in IEEE-SA activities. An individual is not excused from compliance with this policy by reason of any claim of a conflicting obligation (whether contractual or otherwise) that prohibits disclosure of affiliation.

- From the IEEE SA Standards Board Operations Manual

- **5.3.3.1 Disclosure of affiliation** (<http://standards.ieee.org/guides/opman/sect5.html#5.3.3.1>)

- Each participant's affiliation shall be disclosed at any working group or project meeting. The chair or the chair's delegate shall inform the meeting of the requirement for disclosure of affiliation (see [5.2.1.5](#) of the *IEEE-SA Standards Board Bylaws*). This shall be via a sign-in (e.g., sign-in sheet, electronic sign-in, verbal disclosure, or electronic communication) that provides for disclosure of employer and any other affiliation, a reminder of the definition of affiliation, and possible penalties for non-compliance.

Whenever an individual is aware that the ownership of his or her employer or other affiliation may be material to the process, or when the Sponsor or the IEEE-SA Standards Board requests, that individual shall also declare the "ultimate parent entity" of their affiliation. The ultimate parent entity is an entity that directly or indirectly, through one or more intermediaries, controls the entity identified as the individual's affiliation. For the purposes of this definition, the term "control" and its derivatives, with respect to for-profit entities, means the legal, beneficial or equitable ownership, directly or indirectly, of more than fifty percent (50%) of the capital stock (or other ownership interest, if not a corporation) of an entity ordinarily having voting rights. "Control" and its derivatives, with respect to nonprofit entities, means the power to elect or appoint more than fifty percent (50%) of the Board of Directors of an entity.

- **5.3.3.2 False or misleading disclosure** (<http://standards.ieee.org/guides/opman/sect5.html#5.3.3.2>)

- A meeting attendee who fails to disclose affiliation shall not accrue any membership rights, including rights of or towards voting membership, until such disclosures have been made. The chair shall review the adequacy of disclosures. Failure to disclose affiliation, or materially false or misleading disclosure of affiliation, shall result in loss of membership privileges and may also result in loss of other participation privileges within the IEEE-SA for such participants and any affiliated entities

# Future Meetings

- Future Meeting information at:
  - <http://ieee802.org/3/interims/index.html>
- Jan 2009 Interim
  - Jan 12 - 16
  - New Orleans, LA
- March 2009 Plenary
  - March 8 – 13
  - Hyatt Regency Vancouver and Fairmont Hotel
  - Vancouver, BC, Canada



Thank You!

