



IEEE P802.3ba 40Gb/s and 100Gb/s Ethernet Task Force

Agenda and General Information

Atlanta, GA
November, 2009



Agenda

- Welcome and Introductions
- Approve Agenda
- Approve the Minutes
- Goals for this Week
- Ground Rules
- Reflector and Web
- IEEE
 - Structure
 - Bylaws and Rules
 - Call for Patents
 - IEEE Standards Process
- Chief Editor Opening Report
- Comment Resolution D2.3
- Liaisons
- Motions & Closing Business
- Future Meetings

Task Force Decorum



- Press (i.e., anyone reporting publicly on this meeting) are to announce their presence (2007 SASB Op Manual 5.3.3.5)
- Photography or recording by permission only (5.3.3.4)
- Cell phone ringers off
- Wear your badges at all times in meeting areas

Goals for the Week

■ Big Ticket Items

- ❑ Progress Towards Sponsor Ballot - Respond to comments against IEEE P802.3ba Draft 2.3
- ❑ Lay groundwork for the next meeting - Draft 3.0
- ❑ Make request to 802.3WG to go to Sponsor Ballot
- ❑ Provide a response to the 802.3WG on the OIF Liaison

IEEE P802.3ba Task Force Officers and Editors

<u>John D'Ambrosia</u>	Task Force Chair
<u>Ilango Ganga</u>	Task Force Chief Editor Editor – Clauses 1, 4, 80, Annexes A, 4A
<u>Mark Gustlin</u>	Chair, “Logic” Sub-task Force Editor – Clauses 81, 82
<u>Chris DiMinico</u>	Chair, “Cu” Sub-task Force Editor – Clause 85
<u>Pete Anslow</u>	Chair, “Optical” Sub-task Force Editor – Clause 88
<u>Hugh Barrass</u>	Editor – Clauses 30, 45
<u>Jonathan King</u>	Editor – Clause 87
<u>Arthur Marris</u>	Editor – Clauses 69, 73, 74, 84, Annexes 69A, 69B
<u>Steve Trowbridge</u>	Editor – Clause 83, Annex 83C
<u>Ryan Latchman</u>	Editor – Annex 83A, 83B
<u>Piers Dawe</u>	Editor – Clause 86, 52
<u>George Oulundsen</u>	Task Force Secretary
<u>Frank Chang</u>	Task Force Web Master

Ground Rules

- Based upon IEEE 802.3 Rules
 - Foundation based upon Robert's Rules of Order
 - Anyone in the room may speak
 - Anyone in the room may vote
- **RESPECT**... give it, get it
- NO product pitches
- NO corporate pitches
- NO prices!!!
 - This includes costs, ASPs, etc. no matter what the currency
- NO restrictive notices

Reflector and Web

- To subscribe to the IEEE P802.3ba Task Force reflector, send an email to:

ListServ@ieee.org

with the following in the body of the message (do not include “<>”):

***subscribe stds-802-3-hssg <yourfirstname> <yourlastname>
end***

- Send IEEE P802.3ba Task Force reflector messages to:

STDS-802-3-HSSG@listserv.ieee.org

- Task Force web page URL:

http://www.ieee802.org/3/ba/

IEEE P802.3ba Private Area

- URL: <http://www.ieee802.org/3/ba/private/>
 - Username: 802.3ba
 - Password: xxxxxxxx

- Write it down...

- Note - The draft is posted for your review only, and neither the draft nor access information should be copied or redistributed to others in violation of document copyrights.

Task Force Approved Project Documents

■ PAR

- http://ieee802.org/3/ba/PAR/par_0308.pdf

■ 5 Criteria

- http://ieee802.org/3/ba/PAR/P802.3ba_5C_0908.pdf

■ Objectives

- http://ieee802.org/3/ba/PAR/P802.3ba_Objectives_0709.pdf

IEEE Structure

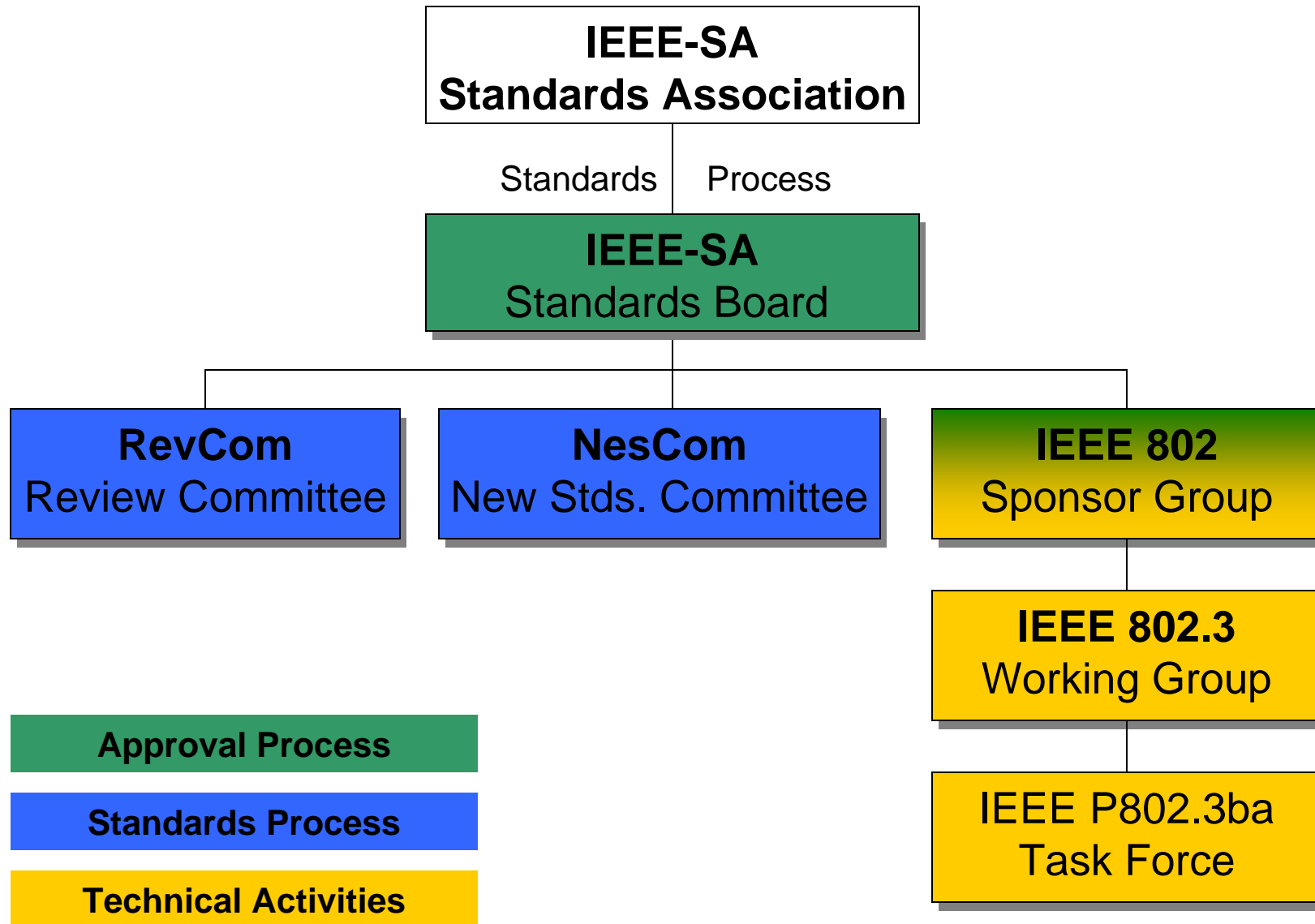

Bylaws and Rules

- **IEEE-SA Operations Manual:**
 - <http://standards.ieee.org/sa/sa-om.pdf>
- **IEEE-SA Standards Board Bylaws:**
 - <http://standards.ieee.org/guides/bylaws/sb-bylaws.pdf>
- **IEEE-SA Standards Board Operations Manual:**
 - <http://standards.ieee.org/guides/opman/sb-om.pdf>
- **IEEE 802 LAN/MAN Standards Committee (LMSC) Policies and Procedures:**
 - http://standards.ieee.org/board/aud/LMSC_2009.pdf
- **IEEE 802 LAN/MAN Standards Committee (LMSC) Operations Manual:**
 - http://www.ieee802.org/PNP/2008-11/LMSC_OM_approved_081114.pdf
- **IEEE 802.3 Working Group Operating Rules:**
 - http://ieee802.org/3/rules/P802_3_rules.pdf

Participants, Patents, and Duty to Inform

All participants in this meeting have certain obligations under the IEEE-SA Patent Policy. Participants:

- ❑ “Shall inform the IEEE (or cause the IEEE to be informed)” of the identity of each “holder of any potential Essential Patent Claims of which they are personally aware” if the claims are owned or controlled by the participant or the entity the participant is from, employed by, or otherwise represents
 - “Personal awareness” means that the participant “is personally aware that the holder may have a potential Essential Patent Claim,” even if the participant is not personally aware of the specific patents or patent claims
- ❑ “Should inform the IEEE (or cause the IEEE to be informed)” of the identity of “any other holders of such potential Essential Patent Claims” (that is, third parties that are not affiliated with the participant, with the participant’s employer, or with anyone else that the participant is from or otherwise represents)
- ❑ The above does not apply if the patent claim is already the subject of an Accepted Letter of Assurance that applies to the proposed standard(s) under consideration by this group

Quoted text excerpted from IEEE-SA Standards Board Bylaws subclause 6.2

- Early identification of holders of potential Essential Patent Claims is strongly encouraged
- No duty to perform a patent search

Patent Related Links

All participants should be familiar with their obligations under the IEEE-SA Policies & Procedures for standards development.

Patent Policy is stated in these sources:

IEEE-SA Standards Boards Bylaws

<http://standards.ieee.org/guides/bylaws/sect6-7.html#6>

IEEE-SA Standards Board Operations Manual

<http://standards.ieee.org/guides/opman/sect6.html#6.3>

Material about the patent policy is available at

<http://standards.ieee.org/board/pat/pat-material.html>

If you have questions, contact the IEEE-SA Standards Board Patent Committee Administrator at patcom@ieee.org or visit <http://standards.ieee.org/board/pat/index.html>

This slide set is available at <http://standards.ieee.org/board/pat/pat-slideset.ppt>

Call for Potentially Essential Patents

- If anyone in this meeting is personally aware of the holder of any patent claims that are potentially essential to implementation of the proposed standard(s) under consideration by this group and that are not already the subject of an Accepted Letter of Assurance:
 - Either speak up now or
 - Provide the chair of this group with the identity of the holder(s) of any and all such claims as soon as possible or
 - Cause an LOA to be submitted

Other Guidelines for IEEE WG Meetings

- **All IEEE-SA standards meetings shall be conducted in compliance with all applicable laws, including antitrust and competition laws.**
 - **Don't discuss the interpretation, validity, or essentiality of patents/patent claims.**
 - **Don't discuss specific license rates, terms, or conditions.**
 - Relative costs, including licensing costs of essential patent claims, of different technical approaches may be discussed in standards development meetings.
 - Technical considerations remain primary focus
 - **Don't discuss or engage in the fixing of product prices, allocation of customers, or division of sales markets.**
 - **Don't discuss the status or substance of ongoing or threatened litigation.**
 - **Don't be silent if inappropriate topics are discussed ... do formally object.**

See *IEEE-SA Standards Board Operations Manual*, clause 5.3.10 and "Promoting Competition and Innovation: What You Need to Know about the IEEE Standards Association's Antitrust and Competition Policy" for more details.

Overview of IEEE 802.3 Standards Process (1/5)- Study Group Phase

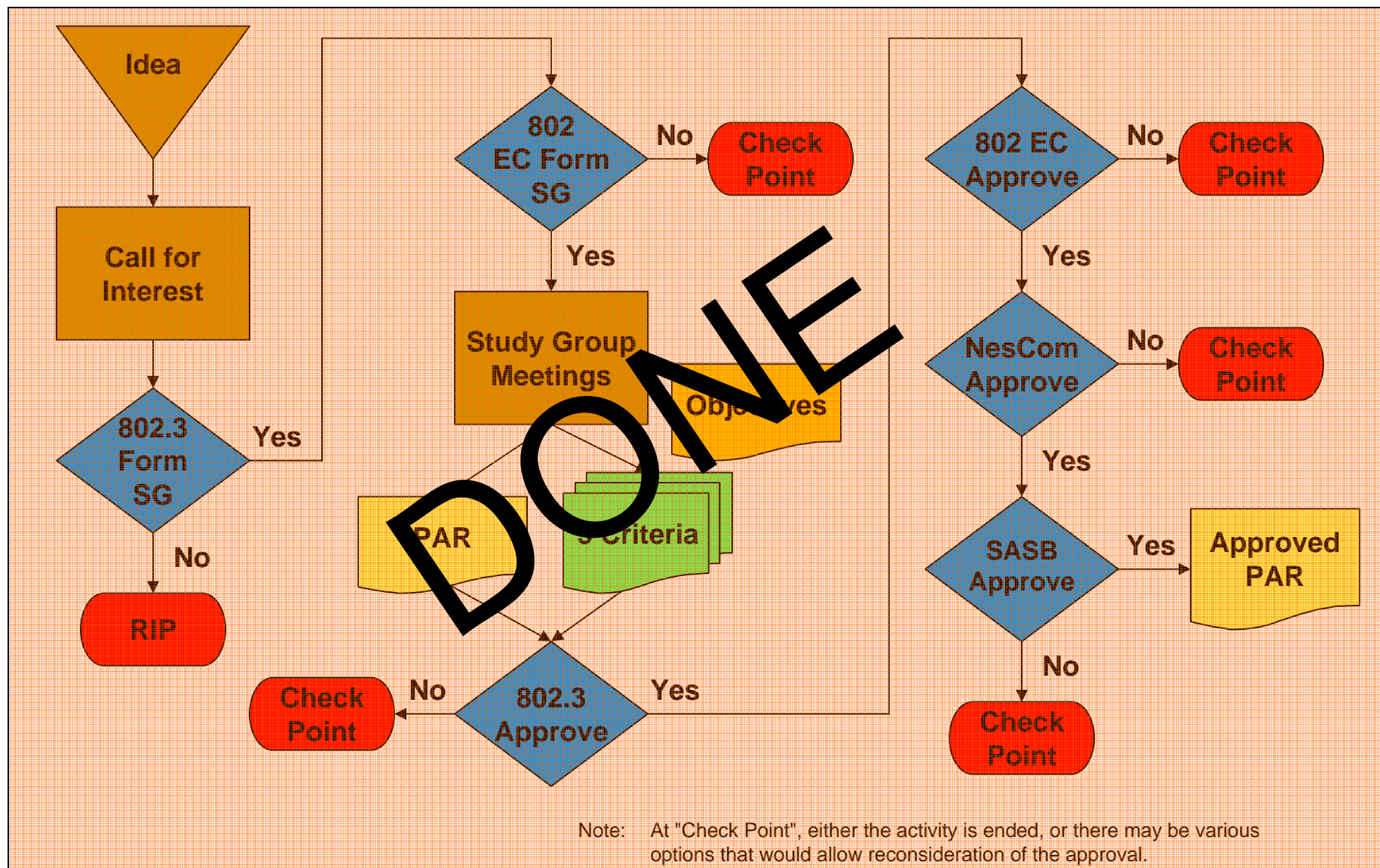

Overview of IEEE 802.3 Standards Process (2/5) - Task Force Comment Phase

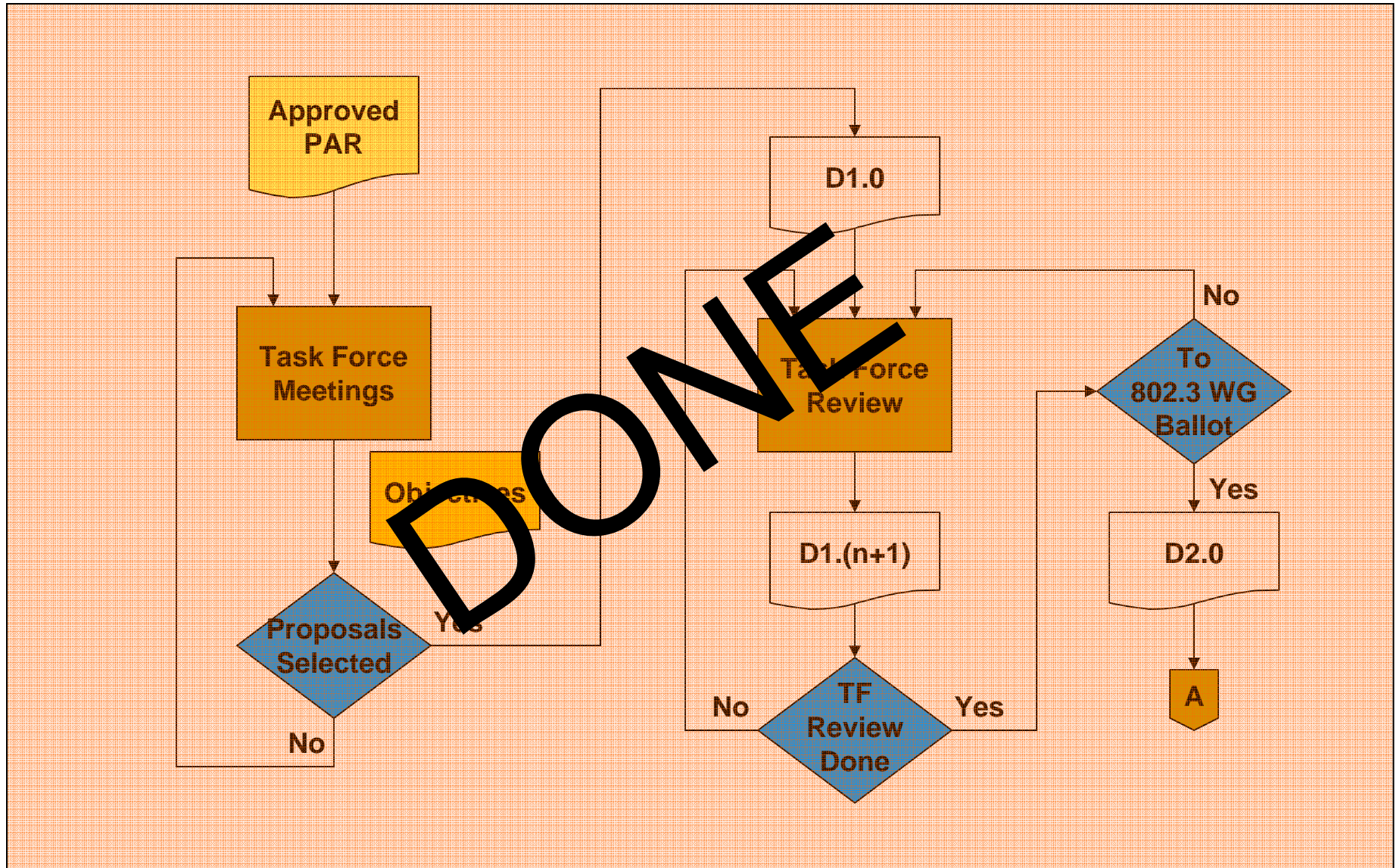

Overview of IEEE 802.3 Standards Process (3/5) - Working Group Ballot Phase

WE ARE HERE

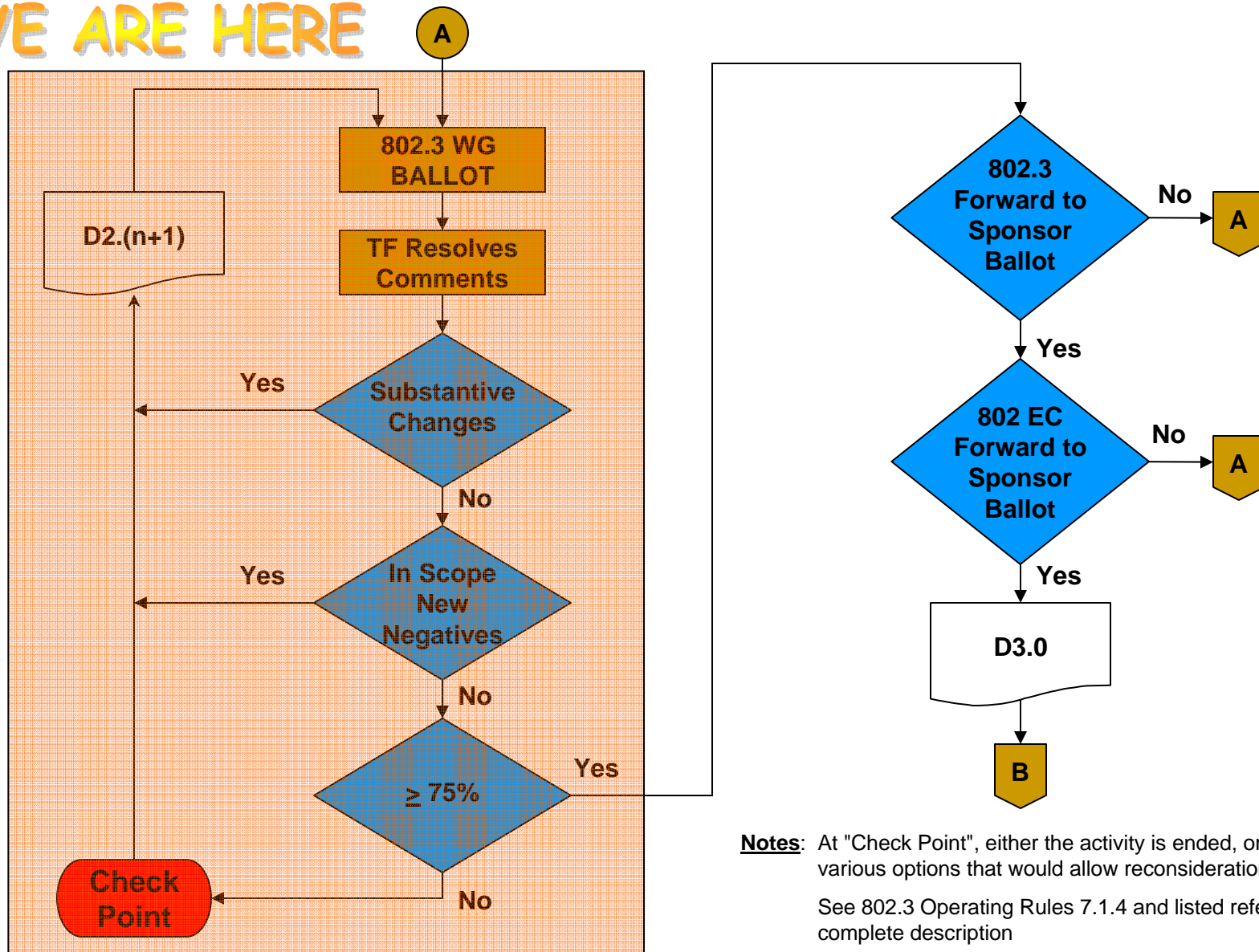

Notes: At "Check Point", either the activity is ended, or there may be various options that would allow reconsideration of the approval. See 802.3 Operating Rules 7.1.4 and listed references for complete description

Overview of IEEE 802.3 Standards Process (4/5)- Sponsor Ballot Phase

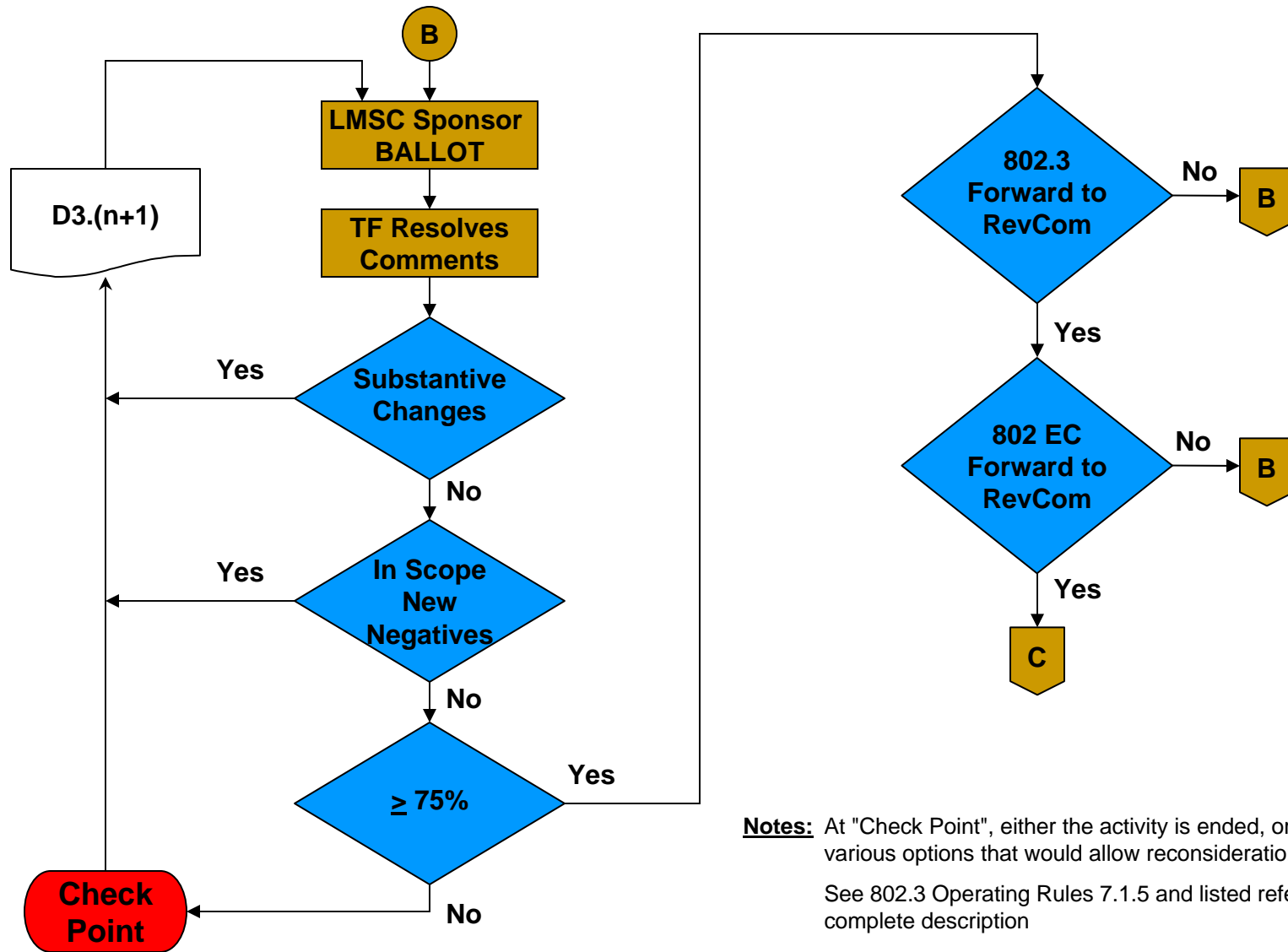

Notes: At "Check Point", either the activity is ended, or there may be various options that would allow reconsideration of the approval. See 802.3 Operating Rules 7.1.5 and listed references for complete description

Overview of IEEE 802.3 Standards Process (5/5) - Final Approvals / Standard Release

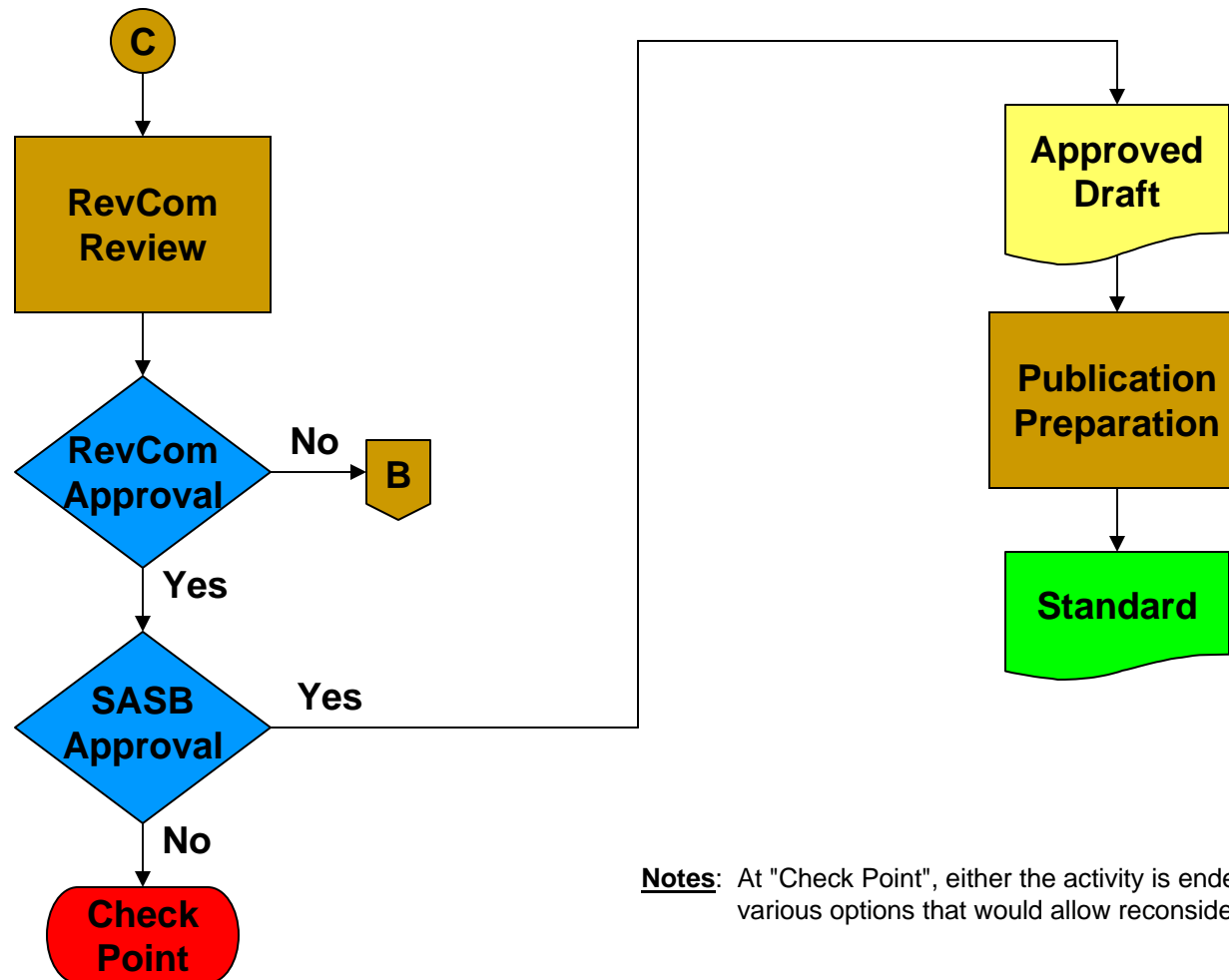

Notes: At "Check Point", either the activity is ended, or there may be various options that would allow reconsideration of the approval.

IEEE P802.3ba Task Force Timeline

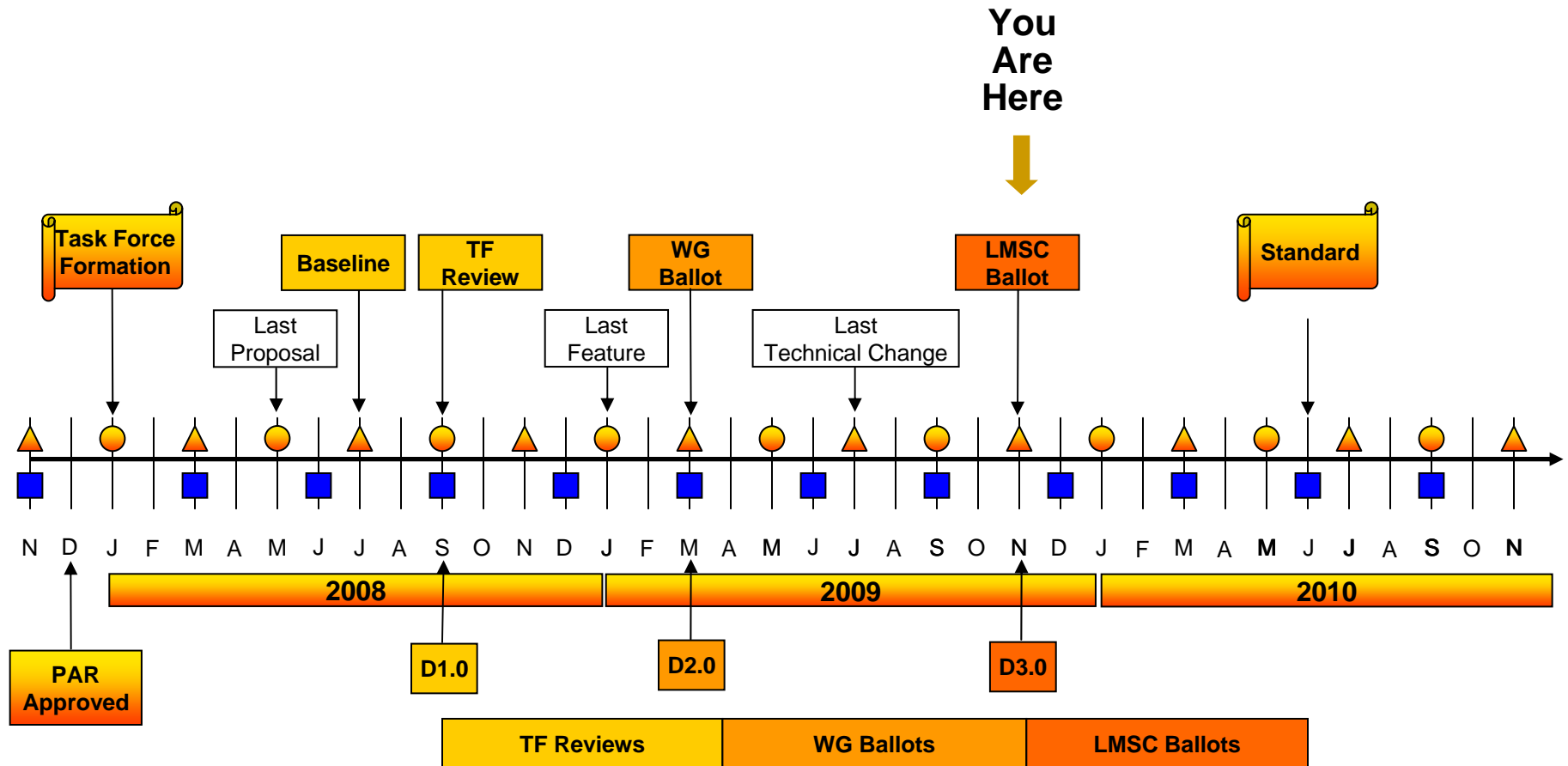

* Adopted by IEEE P802.3ba TF at March 08 Plenary

Legend	
▲	IEEE 802 Plenary
●	IEEE 802.3 Interim
■	IEEE-SA Standards Board

Liaisons

■ OIF

- Liaison Letter -

http://www.ieee802.org/3/ba/public/nov09/OIF_IEEE802.3_liaison_19Oct09.pdf

- Files – See P802.3ba Private Area

- Ad hoc formed – see

<http://www.ieee802.org/3/ba/public/AdHoc/OIF28G/index.html>

■ ITU-T Study Group 15

- Liaison Letter – <http://www.ieee802.org/3/ba/public/nov09/OLS-085.pdf>

- Files – See P802.3ba Private area

■ INCITS T11 Report -

<http://www.ieee802.org/3/ba/public/nov09/INCITS%20T11%20Liaison%20Report%20to%20802%203.pdf>

Meeting Map

	Mon	Tues	Wed	Thur	Fri				
8:00	SEC								
8:30									
9:00			Task Force	Task Force	Task Force - Motions & Closing Business				
9:30									
10:00									
10:30									
11:00	802.0 Plenary								
11:30									
12:00	Lunch	Lunch	Lunch	Lunch					
12:30									
13:00	802.3 Opening Plenary	Task Force	Task Force (OIF CEI Projects Ad Hoc)	802.3 Closing Plenary	SEC				
13:30									
14:00									
14:30									
15:00									
15:30									
16:00									
16:30									
17:00									
17:30									
18:00	CFI								
18:30									
19:00			Social						
19:30									
20:00	Tutorial #1								
20:30									
21:00									
21:30	Tutorial #2								
22:00									

Note –Times listed are subject to change. See individual sub-task force agendas for sub-task force meeting details.

Tuesday
17-Nov-09

Time	Presenter	Affiliation	Title	File Name
9:00 AM	John D'Ambrosia	Force10 Networks	Agenda and General Information	agenda_01_1109.pdf
9:30 AM	Ilango Ganga	Intel	Chief Editor's Opening Report	ganga_01_1109.pdf
10:00 AM	John D'Ambrosia	Force10 Networks	OIF Liaison (Ad hoc): Common Electrical I/O Projects	OIF_IEEE802.3_liaison_19Oct09.pdf
10:10 AM	Pete Anslow	Nortel	ITU-T Study Group 15 Liaison: ITU-T G.709 for Approval	OLS-085.pdf
10:20 AM	Terry Cobb	Systemax	INCITS T11.2 Liaison Report 802.3	INCITS%20T11%20Liaison%20Report%20to%20802%203.pdf
10:30 AM			Break	
10:50 AM			Task Force Comment Resolution	anslow_02_1109.pdf
12:00 PM			Lunch	
1:30 PM			Task Force Comment Resolution	
3:00 PM			Break	
3:20 PM			Task Force Comment Resolution	
5:00 PM			Break for Day	

Wednesday
18-Nov-09

Time	Presenter	Affiliation	Title	File Name
9:00 AM	John D'Ambrosia	Force10 Networks	Opening Comments	
9:10 AM			Task Force Comment Resolution	
10:30 AM			Break	
10:50 AM			Task Force Comment Resolution	
12:00 PM			Lunch	
1:30 PM			OIF Liaison : CEI-25 / CEI-28 Projects Ad hoc	
3:00 PM			Break	
3:20 PM			OIF Liaison : CEI-25 / CEI-28 Projects Ad hoc (cont)	
5:00 PM			Break for Day	

Thursday
19-Nov-09

Time	Presenter	Affiliation	Title	File Name
9:00 AM	John D'Ambrosia	Force10 Networks	Opening Comments	
9:15 AM	Ilango Ganga	Intel	Chief Editor's Closing Report	ganga_02_0109.pdf
9:45 AM			Discussion & Motions	
10:30 AM			Break	
10:50 AM			Discussion, Motions, & Closing Business	
Noon			Adjourn	

Note – Order of presentations and times listed are subject to change.

Future Meetings

- Future Meeting information at:
 - <http://ieee802.org/3/interims/index.html>
- Jan 2010 IEEE 802.3 Interim
 - Jan 25 – 28
 - Marriot Hotel Convention Center
 - New Orleans, LA, USA
- March 2010 IEEE 802 Plenary
 - March 14 - 19
 - Caribe Royale Orlando All Suites Resort and Convention Center
 - Orlando, FL, USA



Thank You!

