40GBASE-T RJ45 ICM Rev.2

IEEE 802.3bq July 2014

Foxconn Interconnect Technology

I. 40GBIT ICM Design

- Keep current FCC RJ45 interface.
- Use optimized RJ45 contact design.



II. ICM Test Setup

VNA Configuration	
VNA Model	E5071C ENA
Start Freq	1 MHz
Stop Freq	2 GHz
Measurement	50Ω, Single Ended
Port Configuration	
RJ-45 Side	Ports 1, 2
PHY Side	Ports 3, 4

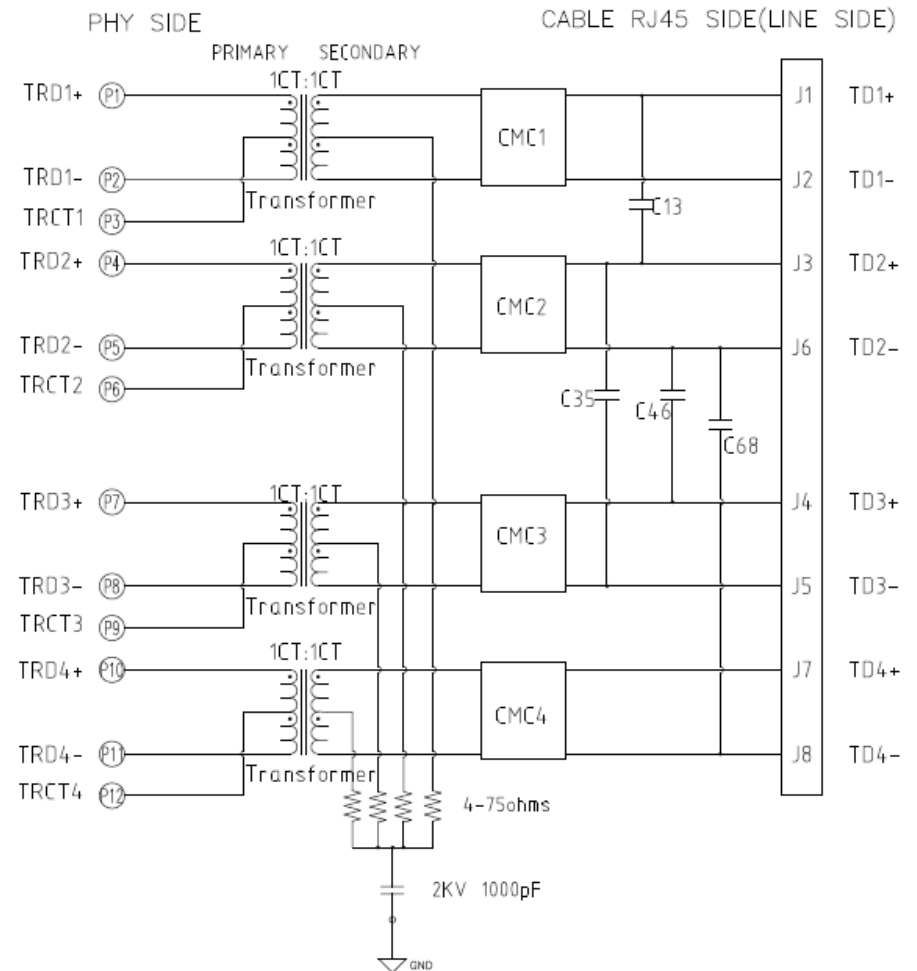
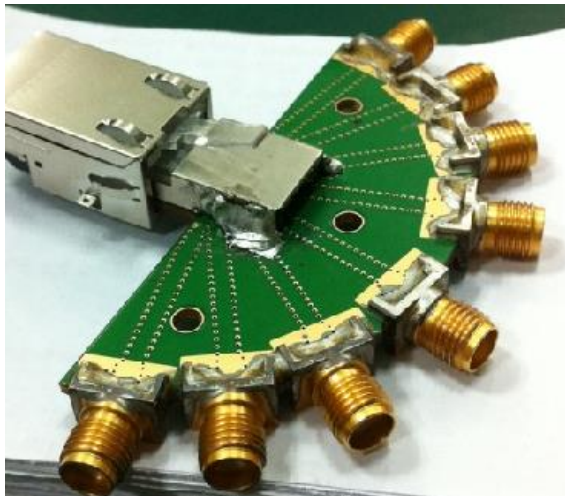

III. ICM S-parameter test

Insertion Loss

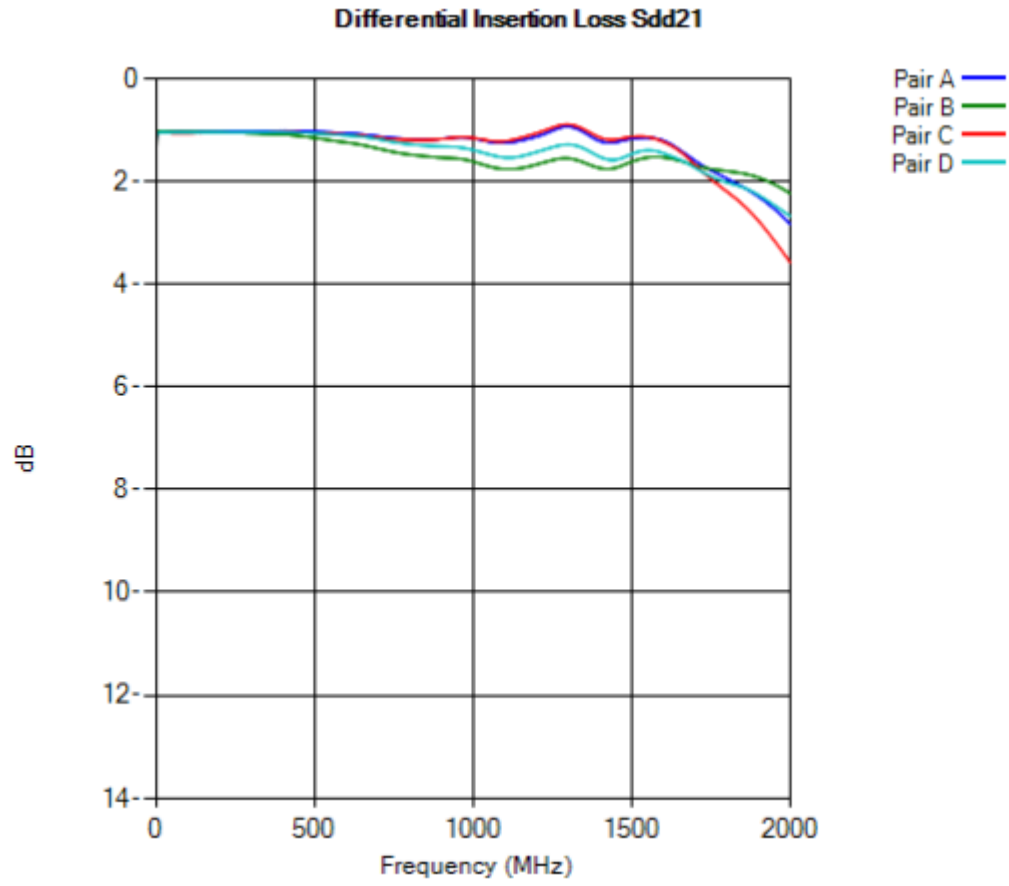

III. ICM S-parameter test

RJ45-side Return Loss

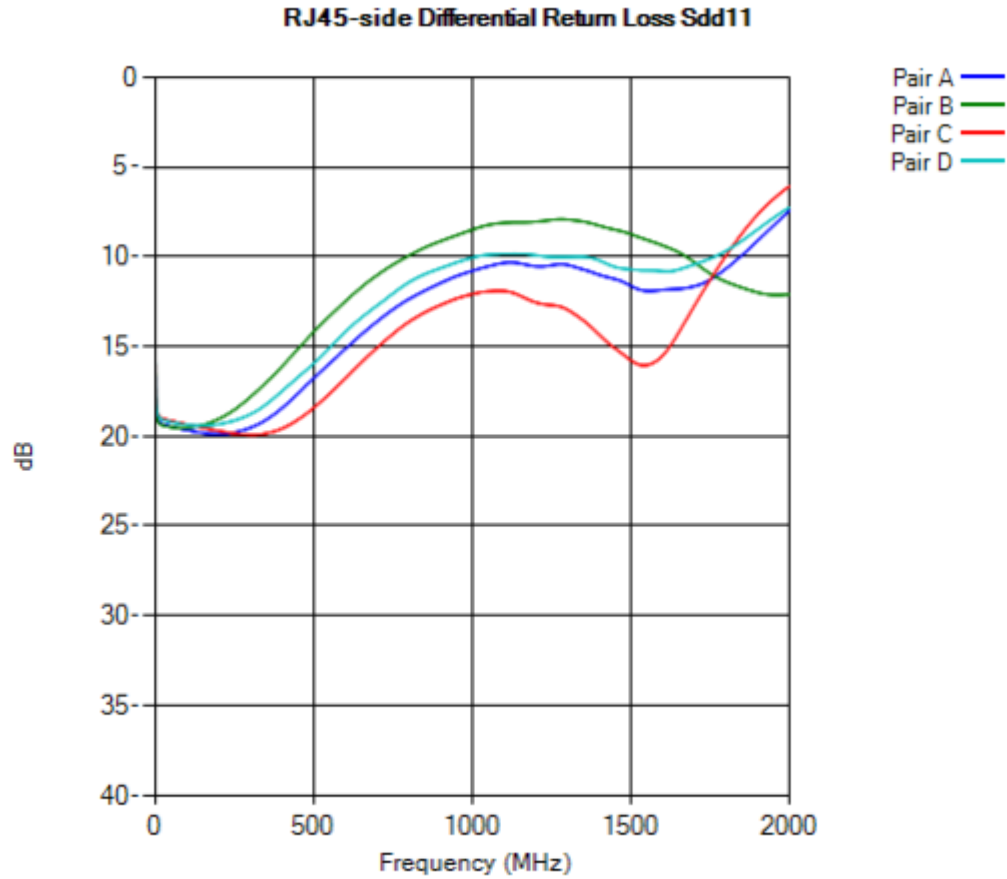

III. ICM S-parameter test

PHY-side Return Loss

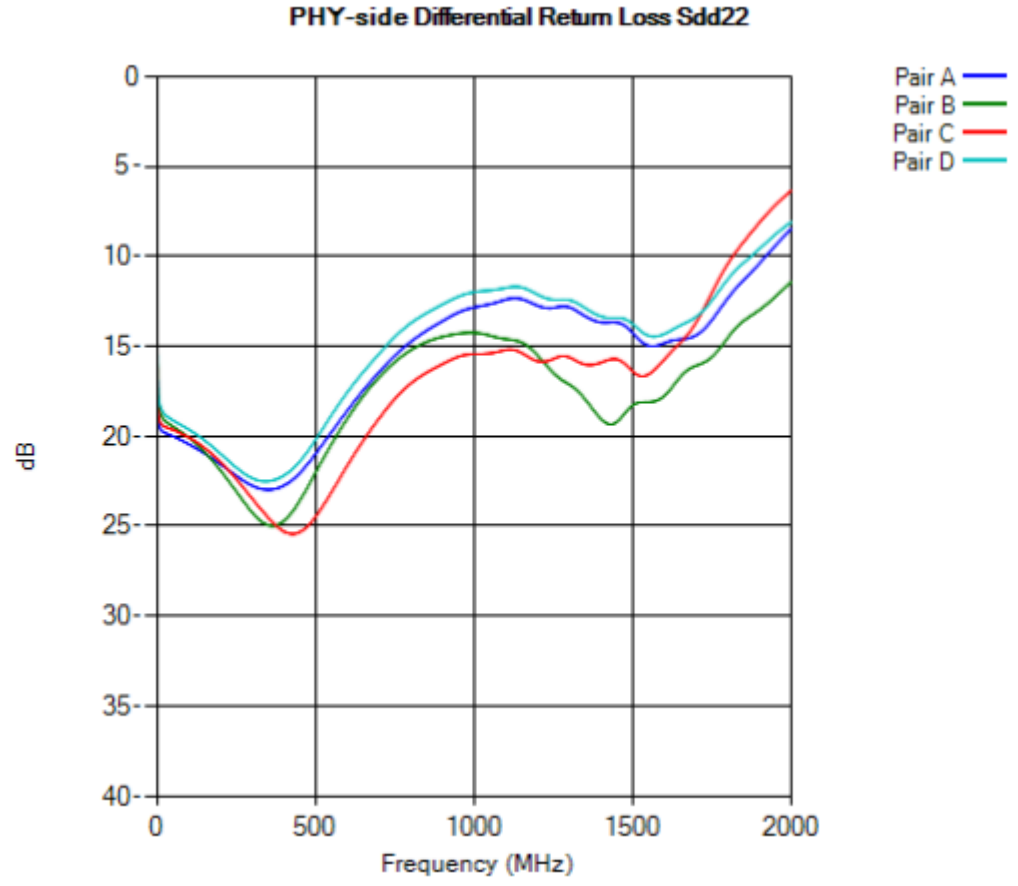

III. ICM S-parameter test

RJ45-side NEXT

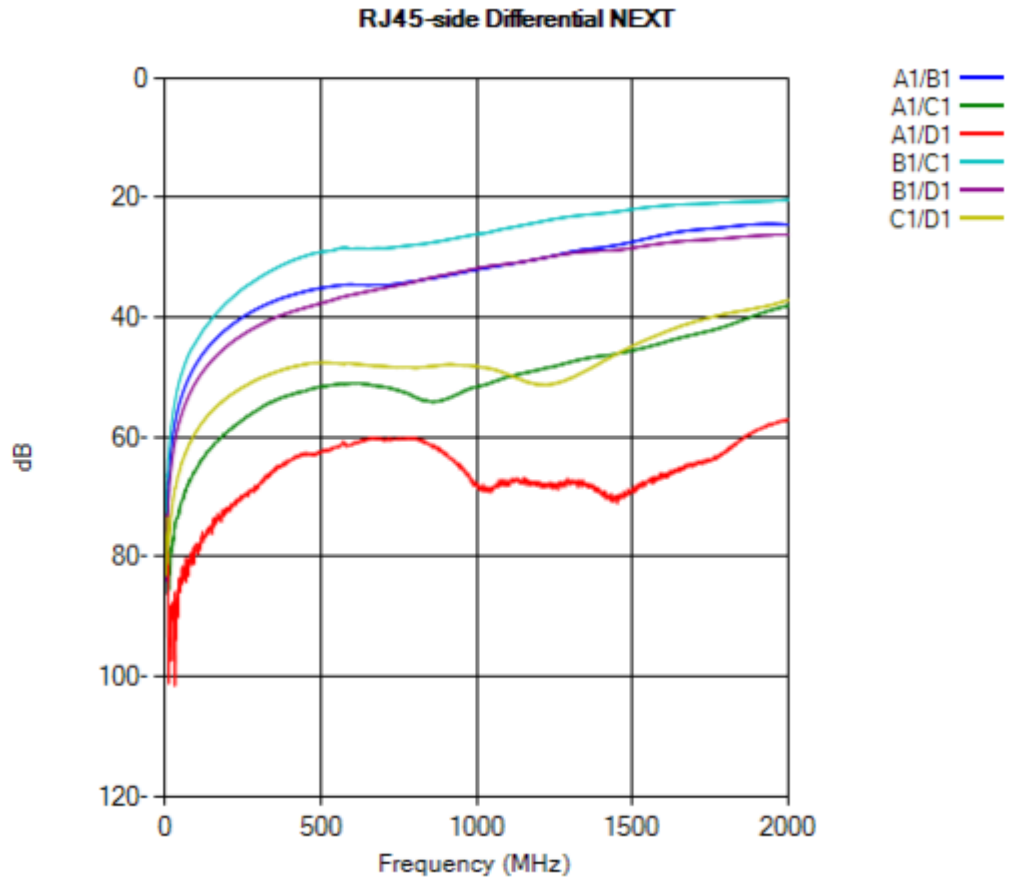

III. ICM S-parameter test

PHY-side NEXT

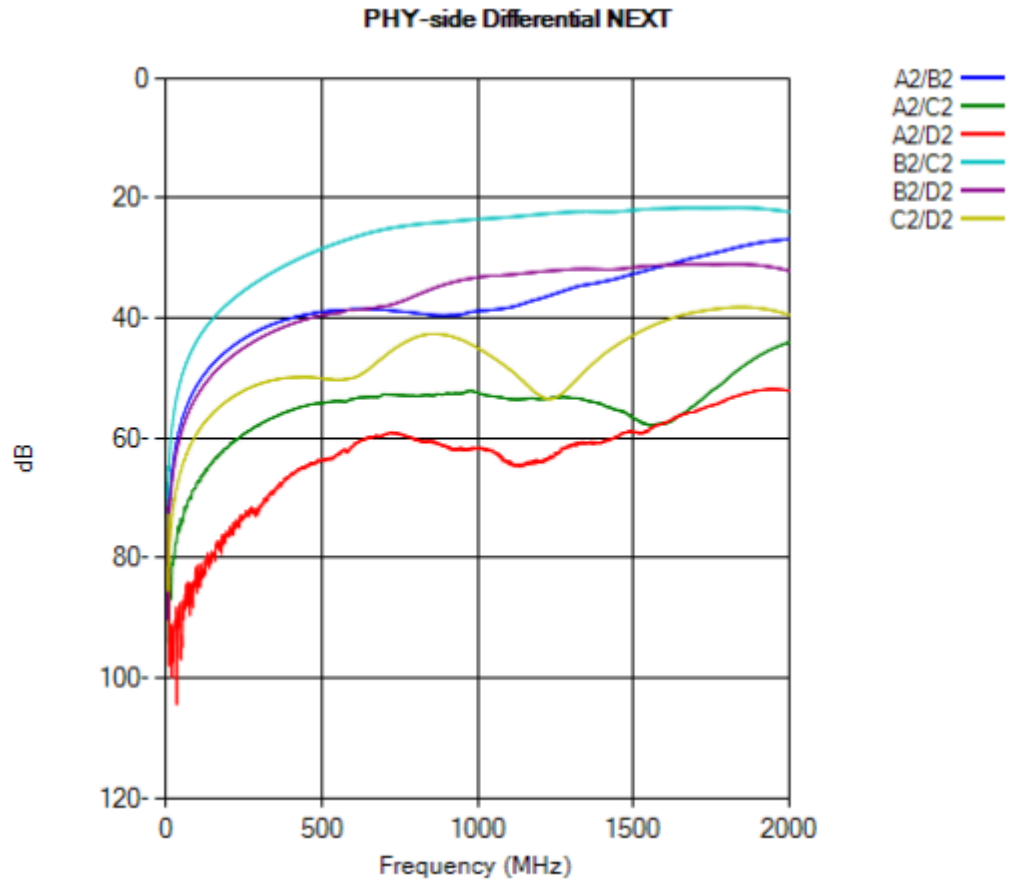

III. ICM S-parameter test

RJ45 to PHY FEXT

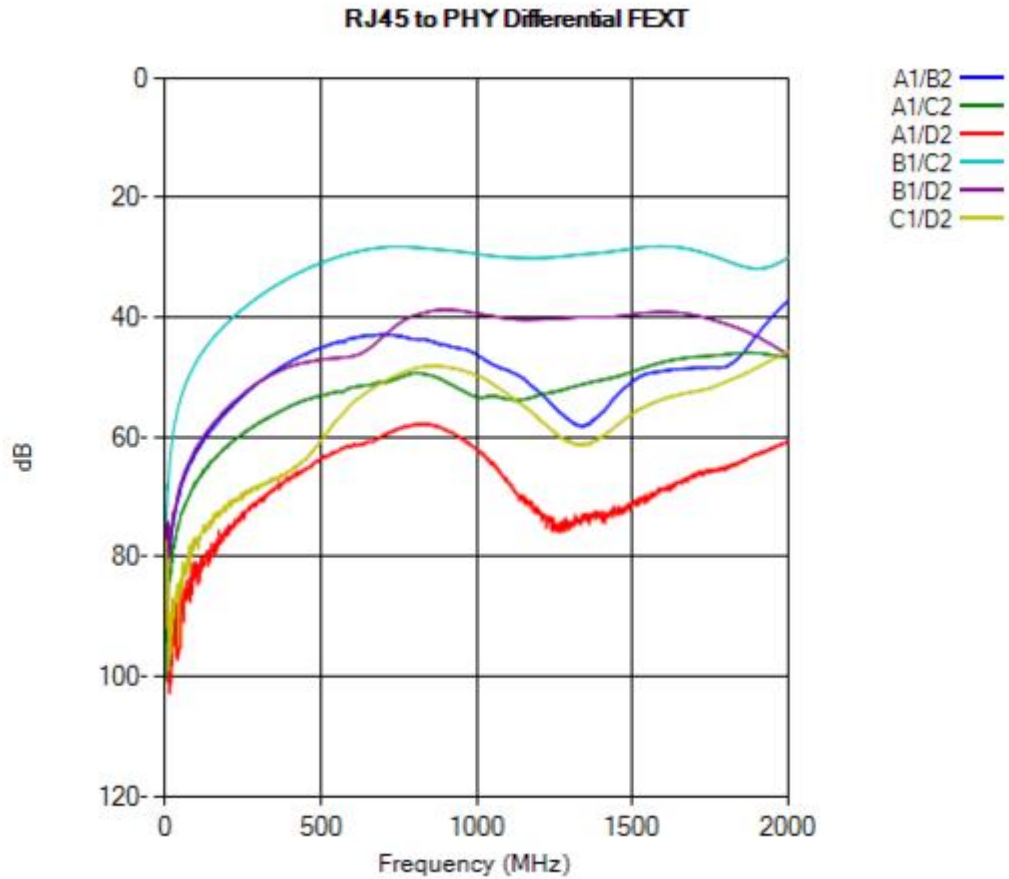

III. ICM S-parameter test

PHY to RJ45 FEXT

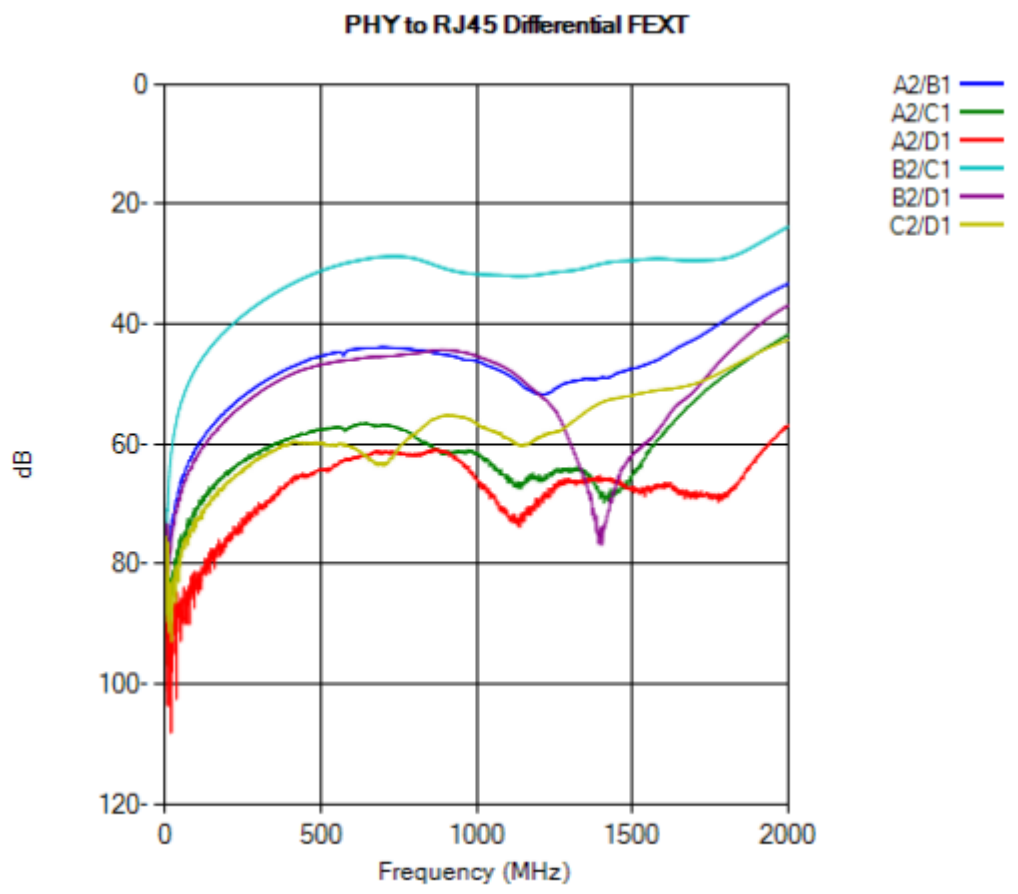

IV. Other parameters

- **Meet IEEE HiPOT specification**
- **Backward compatible with 10G/1G standard RJ 45 configuration**
- **Compatible with 2xN high density port**



Thanks!