

40GBASE-T link segment and PHY channel: Modelling and measurements

IEEE 802.3bq Indian Wells 2014

LEONI

Alexander Franck
M.Eng.
R&D

LEONI Kerpen GmbH
Zweifaller Straße 275-287
52224 Stolberg - Germany
alexander.franck@leoni.com

Authors

- Y. Engels, LEONI Kerpen
- A. Franck, LEONI Kerpen
- A. Oehler, Reutlingen University
- D. Schicketanz, Consultant

Supporters

- V. Maguire, Siemon
- H. Lackner, Qoscom
- M. Rossbach, Nexans
- Y. Belopolsky, Bell Stewart

- H. Heinze, Telegärtner
- R. Dold, BTR
- A. Wasmuth, Prysmian
- C. Pfeiler, Prysmian
- B. Jung, GHMT
- D. Wilhelm, GHMT
- K. Hüdeüppohl, Ideal Industries

Content

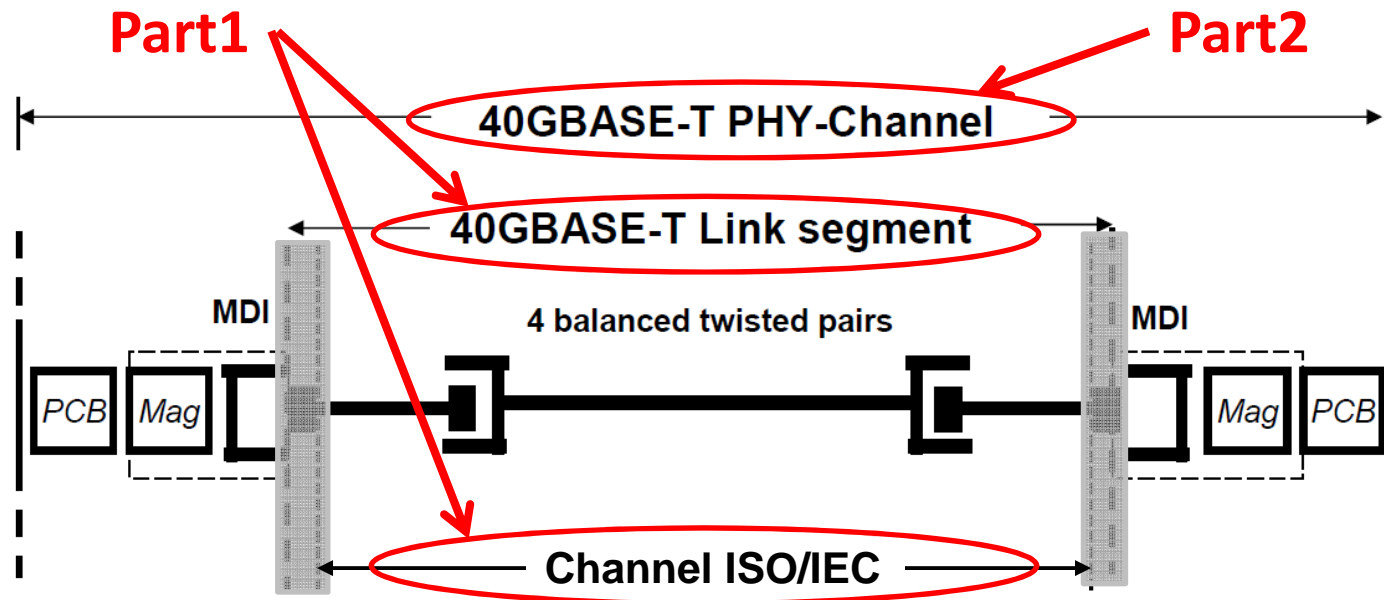

- **Part 1:** Modelling and measurement of long and short ISO/IEC Channel I and Channel II
- **Part 2:** Impact of PCB and MDI on the PHY Channel

Part 1: Modelling and measurements of link segments (ISO/IEC cabling channels)

- Limit line model applied to ISO/IEC class I and class II and comparison to measurements class II
 - The limit line model is under work in ISO/IEC and a proposal for a technical report (WD 11801-99-3) is in process (ISO/IEC JTC 1 N 11897). The concept is to use the component limit lines without phase and process them with the help of the matrix approach.
 - Since not all component values are fixed and in order to reduce complexity at the moment, only the 4x4 S-Matrix is used and the provisional IEC component specifications are taken.

Class I Channel (similar to TIA cat8)

long: 2m-26m-2m

short: 0.5m-3m-0.5m

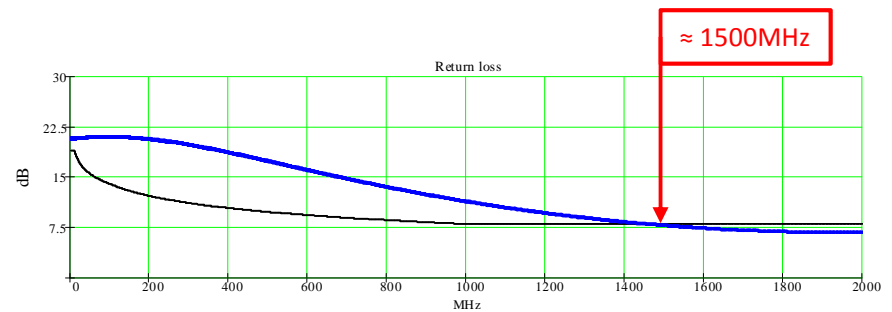
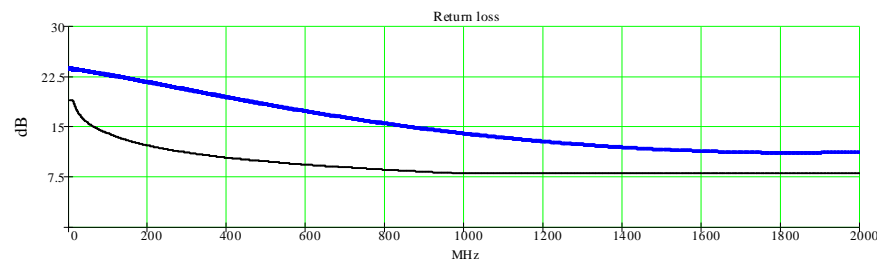
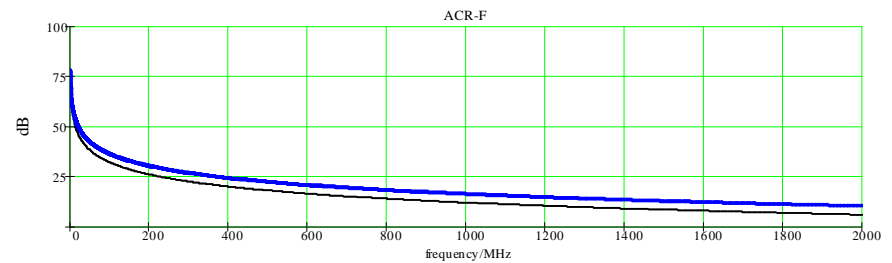
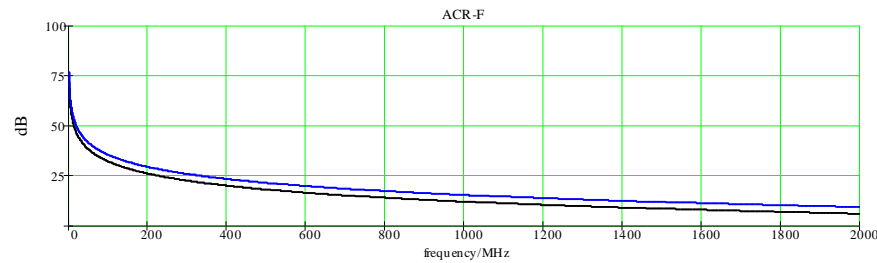
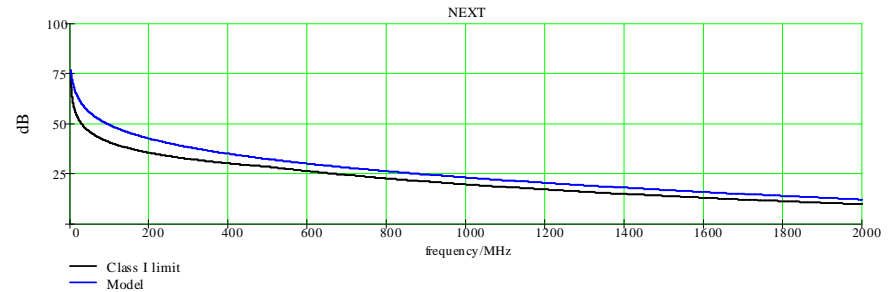
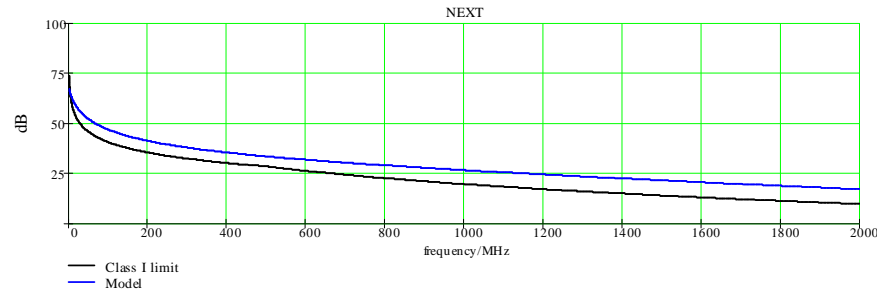

Class II Channel Insertion loss

long: 2m-26m-2m

model

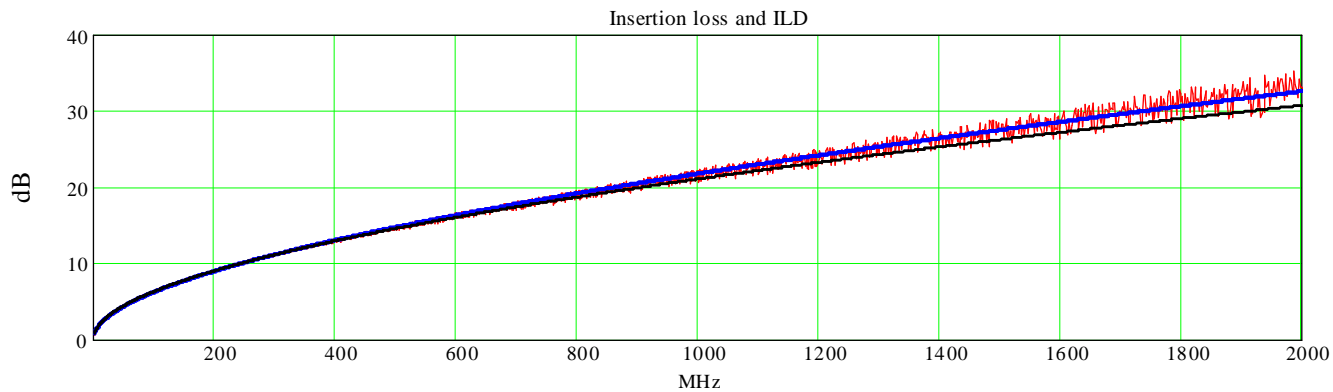

measurement

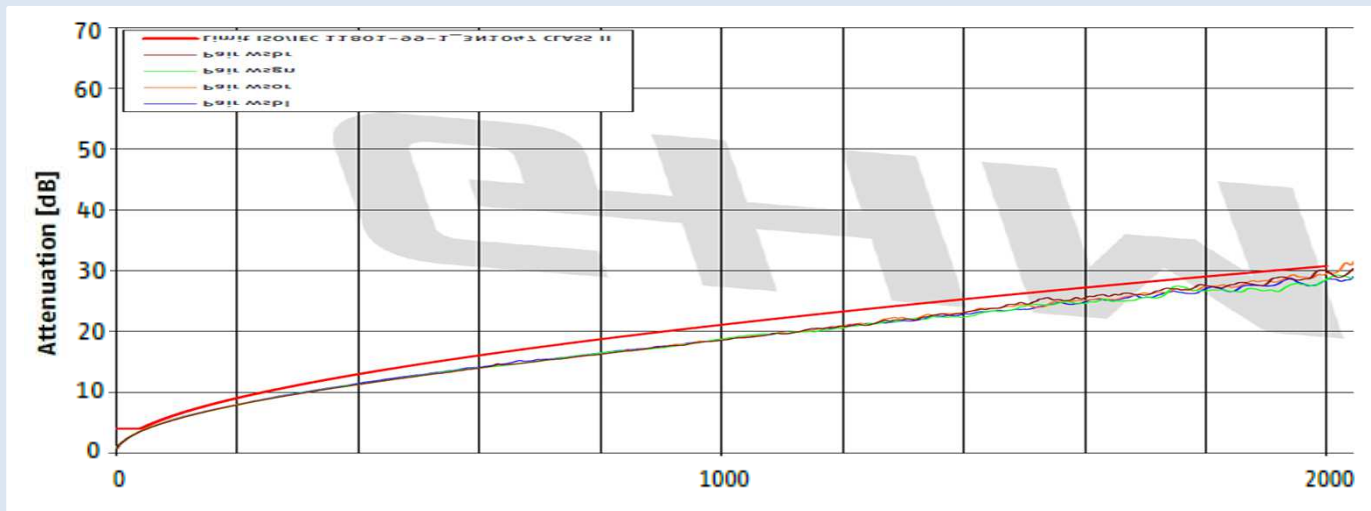

- ISO/IEC 11801-99-1 DTR N 2238 Class II Limits - ISO/IEC 11801-99-1 DTR N 2238 Class II Limits measurements -

Class II Channel Insertion loss

short: 0.5m-3m-0.5m

model

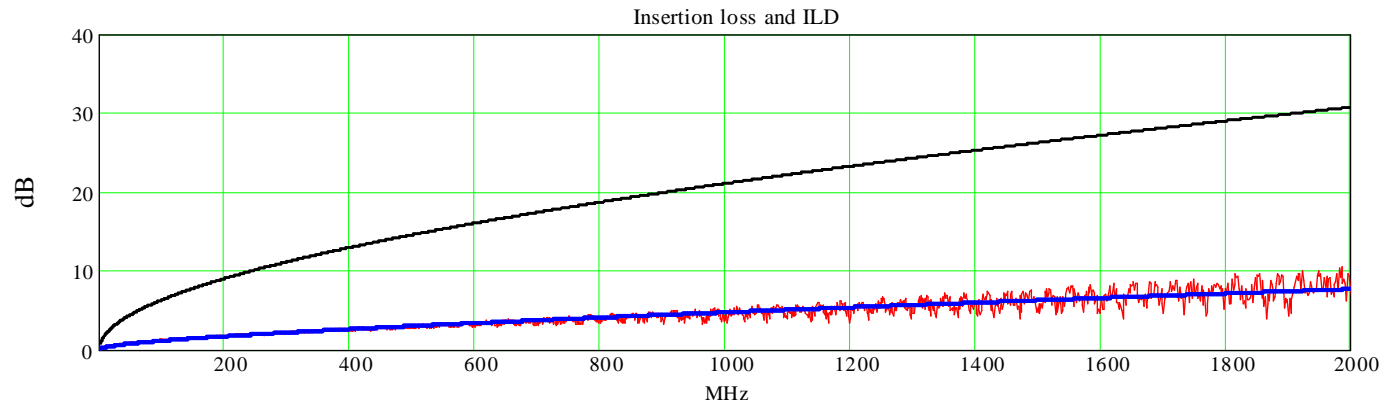

measurement

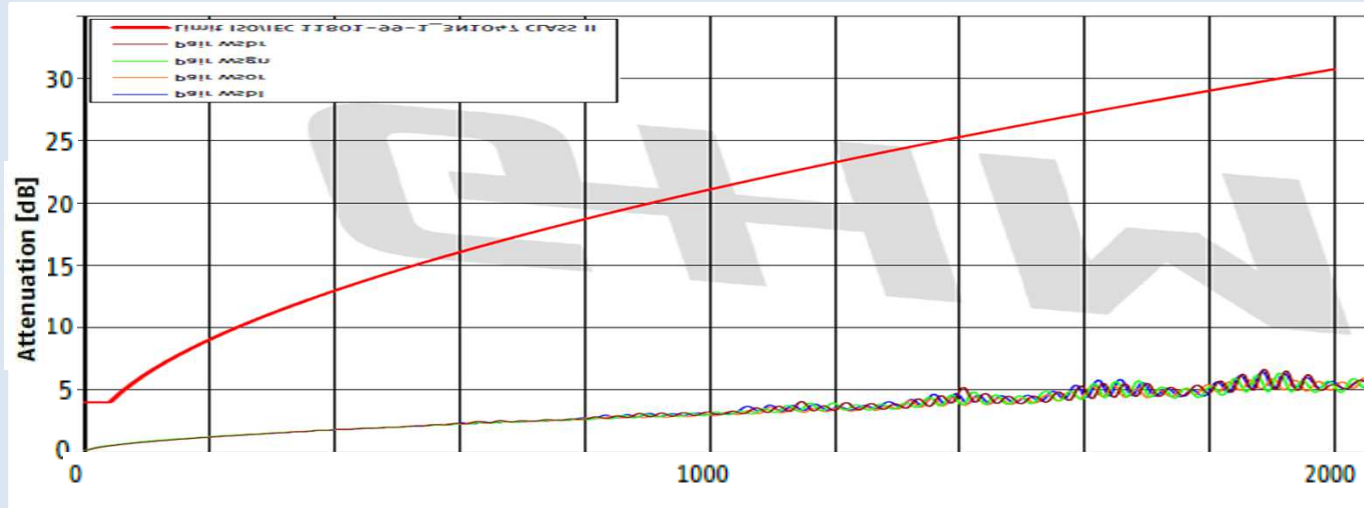

- ISO/IEC 11801-99-1 DTR N 2238 Class II Limits - ISO/IEC 11801-99-1 DTR N 2238 Class II Limits measurements -

Model

Class II Channel Return loss

long: 2m-26m-2m

model

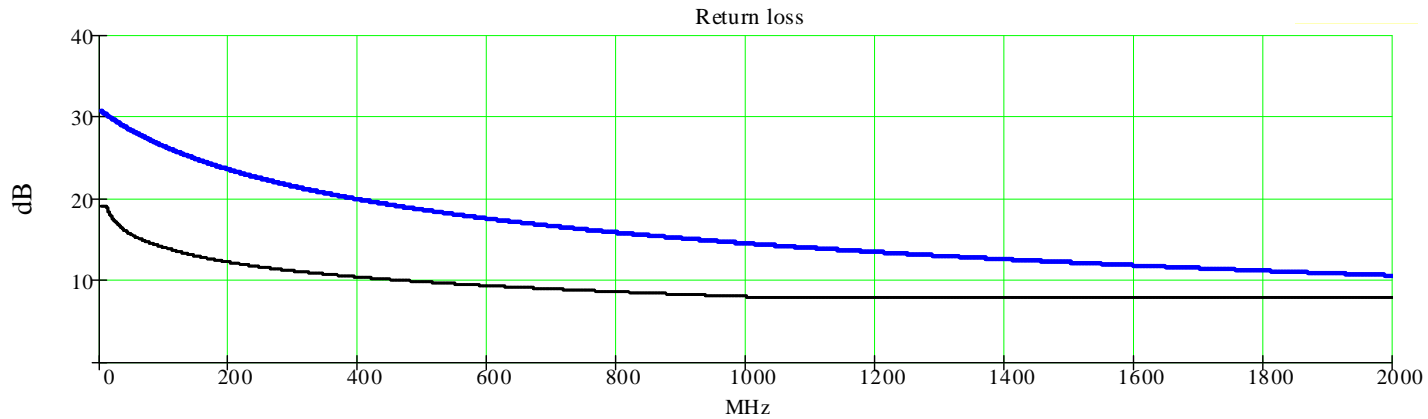

measurement

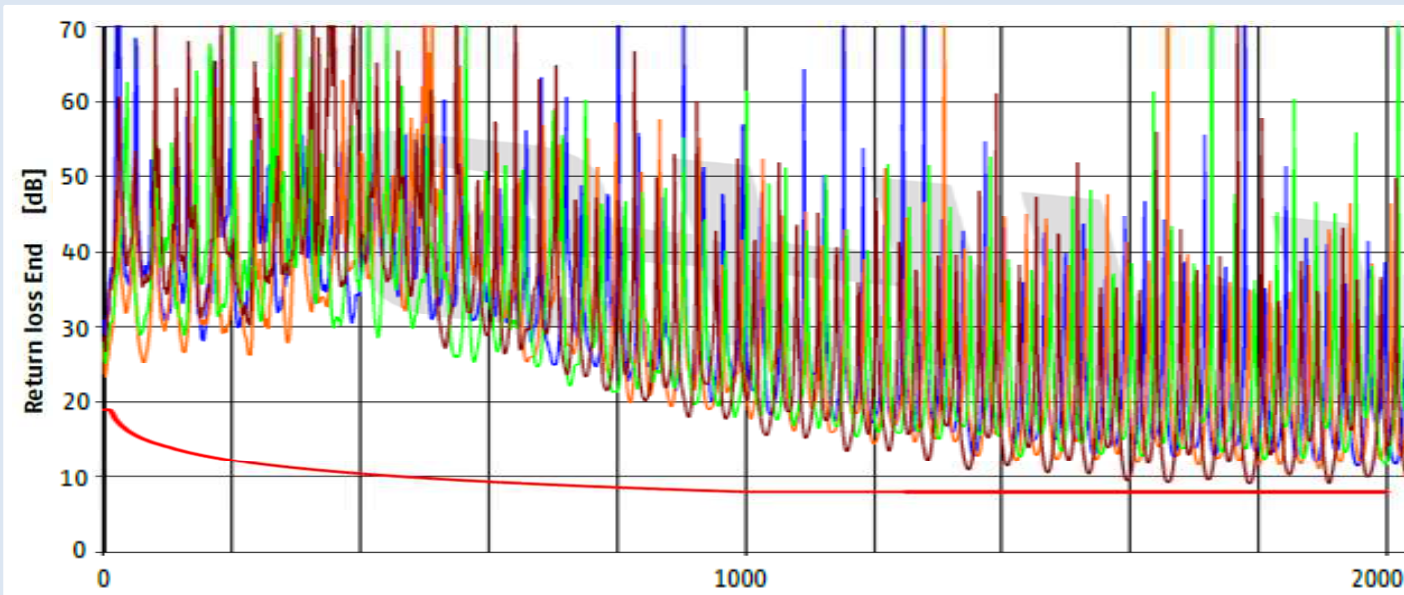

- ISO/IEC 11801-99-1 DTR N 2238 Class II Limits - ISO/IEC 11801-99-1 DTR N 2238 Class II Limits measurements -

Model

Class II Channel Return loss

short: 0.5m-3m-0.5m

model

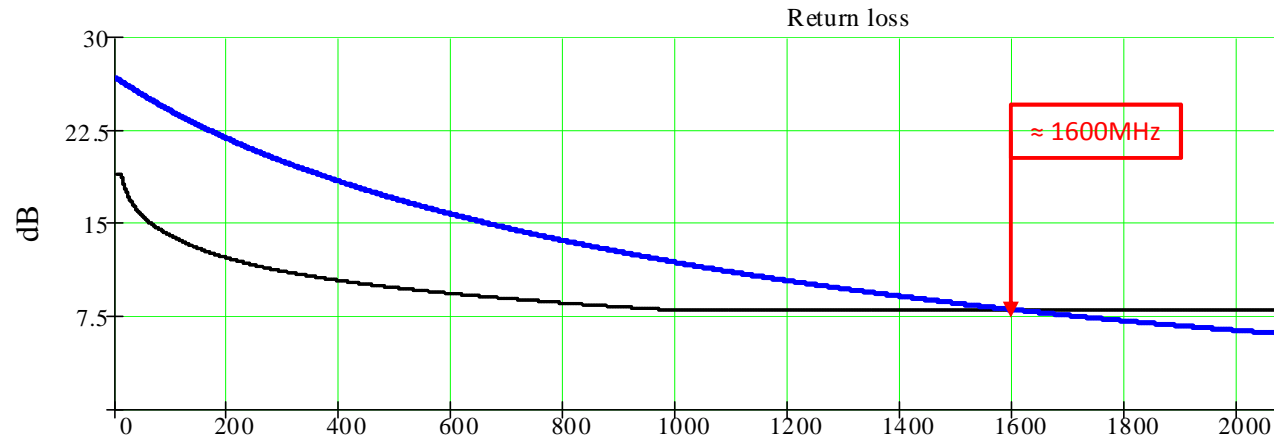

measurement

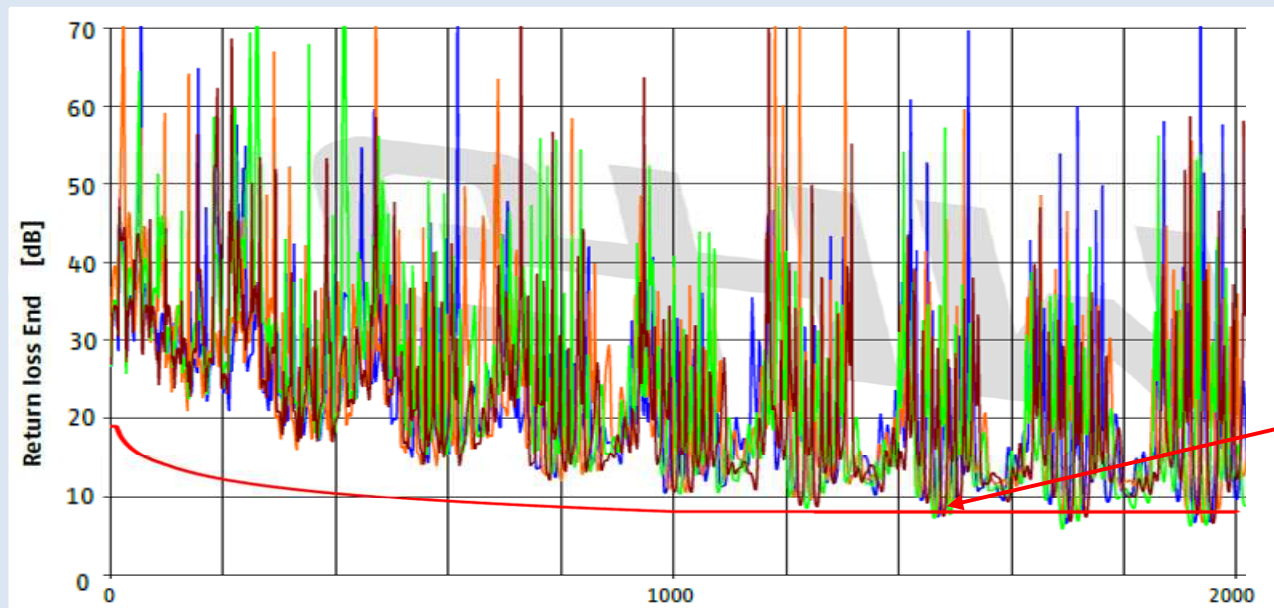

- ISO/IEC 11801-99-1 DTR N 2238 Class II Limits - ISO/IEC 11801-99-1 DTR N 2238 Class II Limits measurements -

Model

Class II Channel NEXT

long: 2m-26m-2m

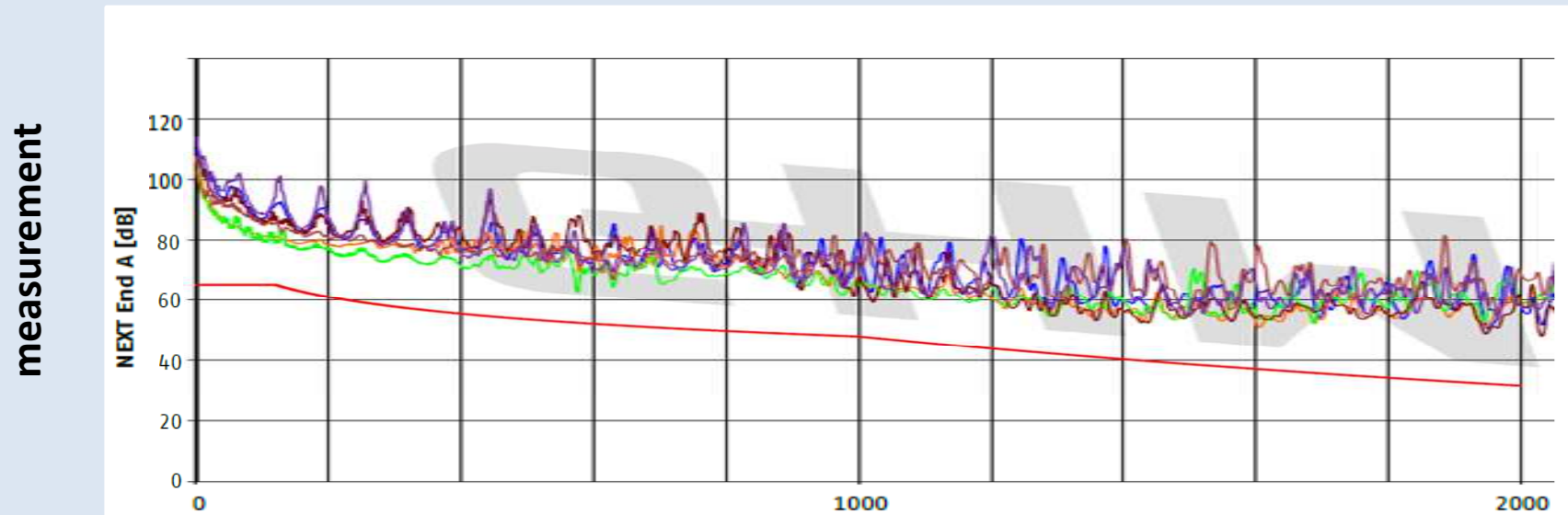
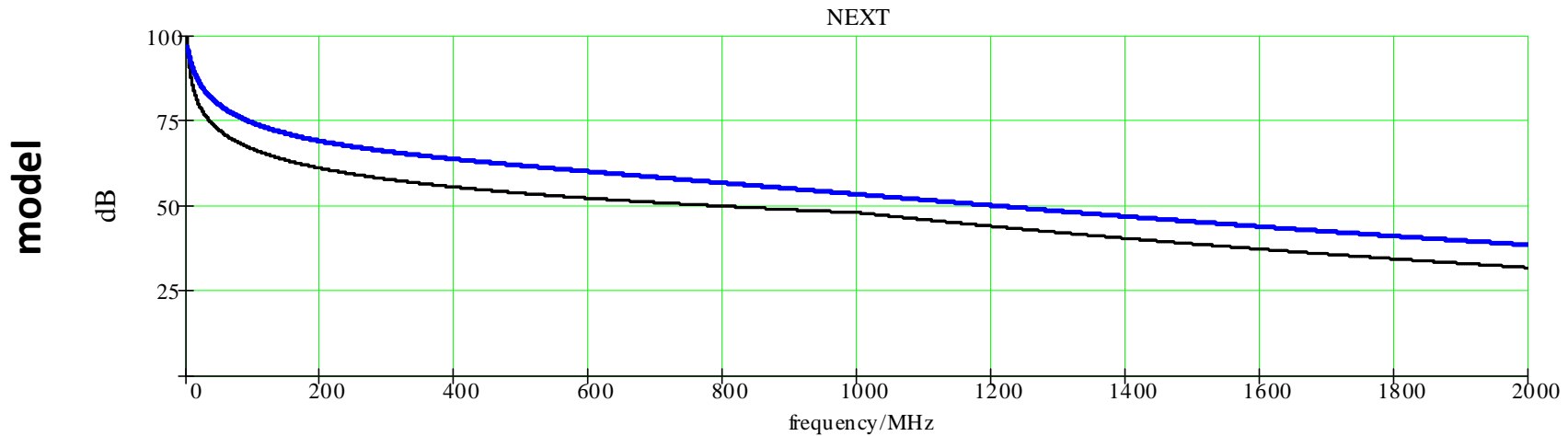

- ISO/IEC 11801-99-1 DTR N 2238 Class II Limits - ISO/IEC 11801-99-1 DTR N 2238 Class II Limits measurements -

Class II Channel NEXT

short: 0.5m-3m-0.5m

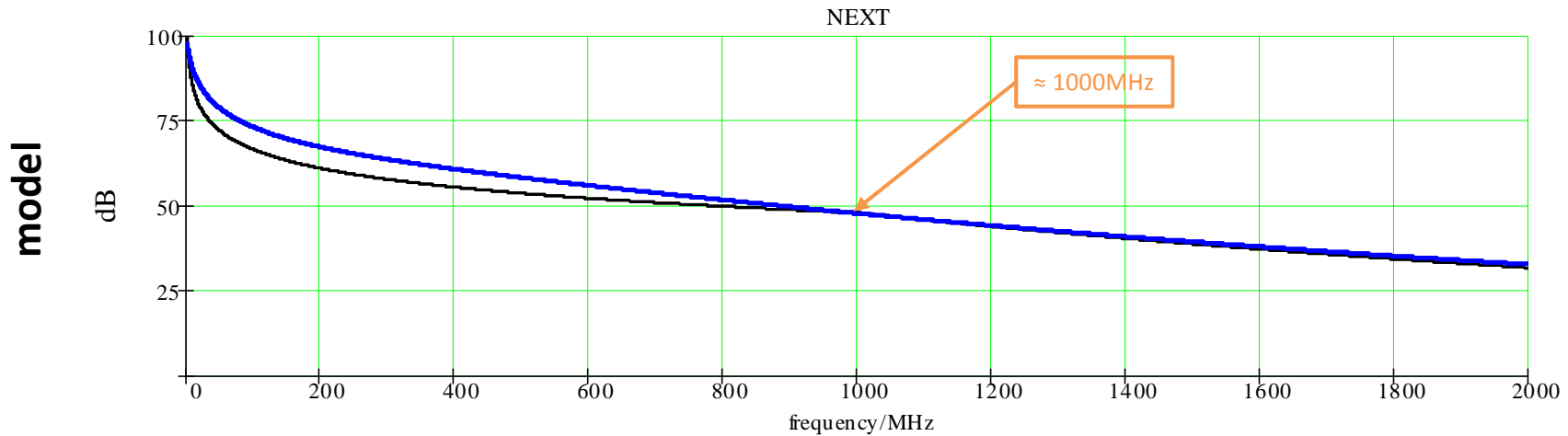

measurement

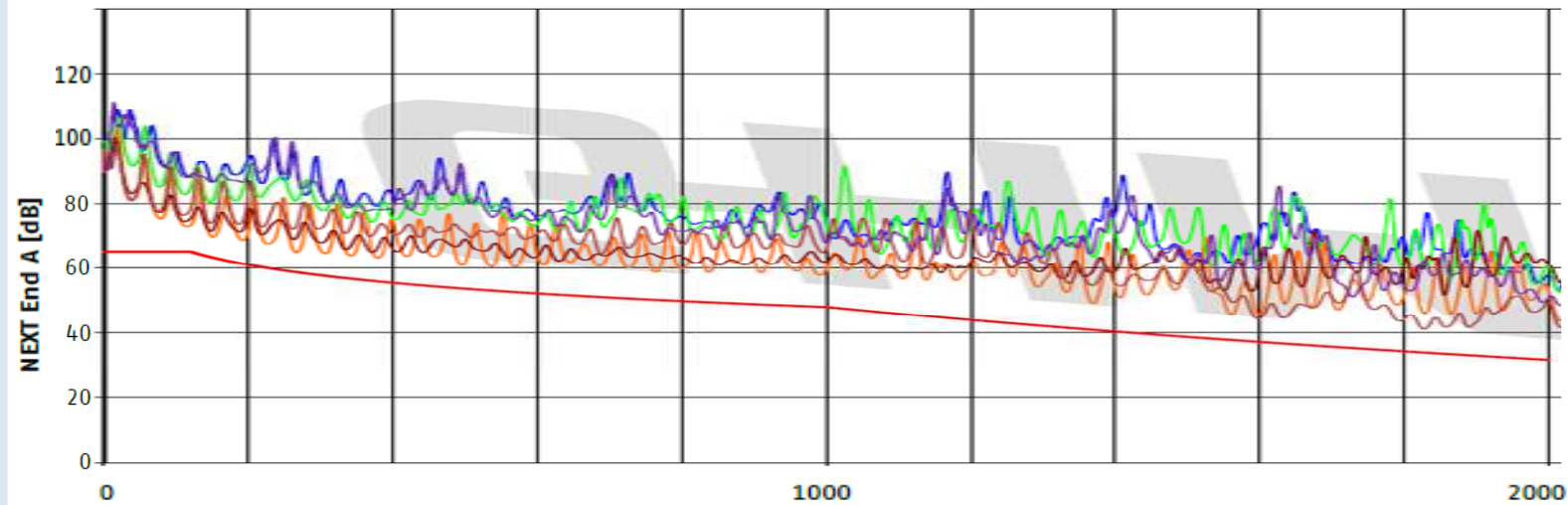

- ISO/IEC 11801-99-1 DTR N 2238 Class II Limits - ISO/IEC 11801-99-1 DTR N 2238 Class II Limits measurements -

Model

Class II Channel ACR-F

long: 2m-26m-2m

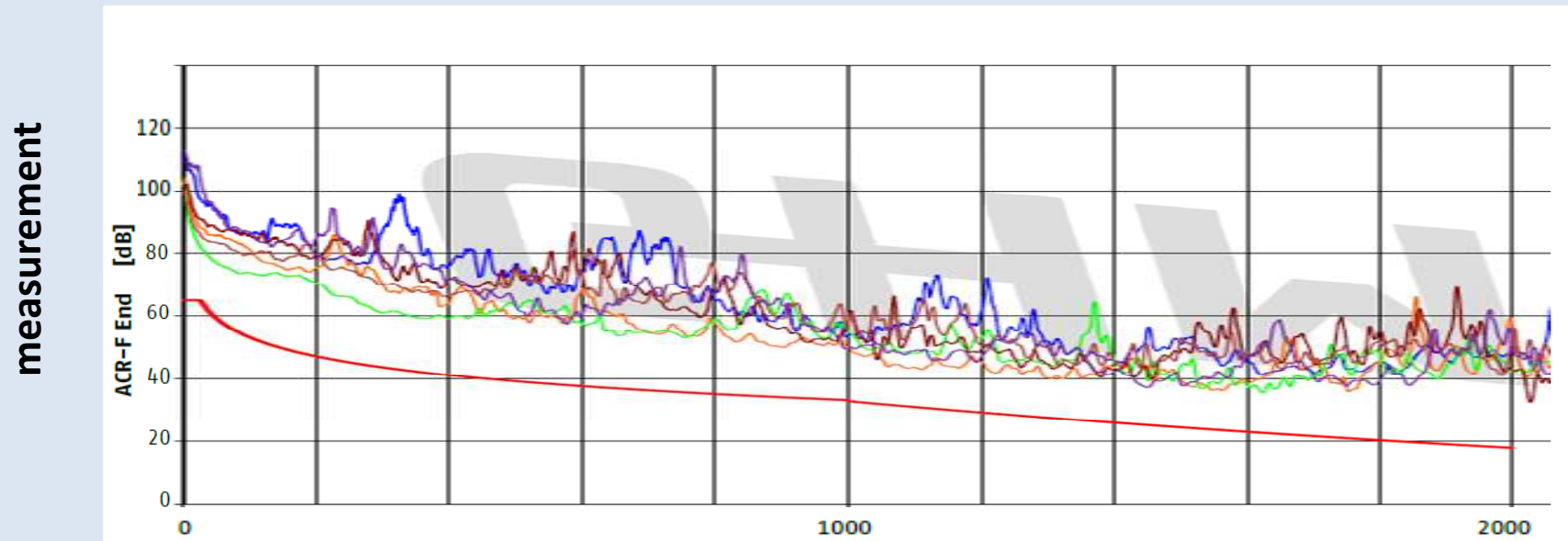
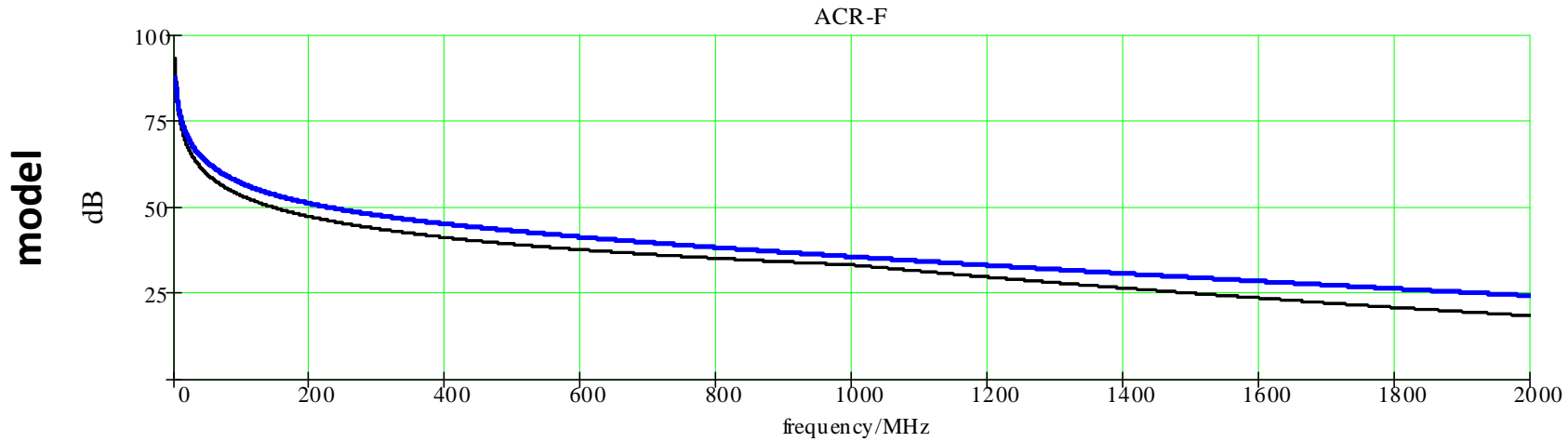

- ISO/IEC 11801-99-1 DTR N 2238 Class II Limits - ISO/IEC 11801-99-1 DTR N 2238 Class II Limits measurements -

Class II Channel ACR-F

short: 0.5m-3m-0.5m

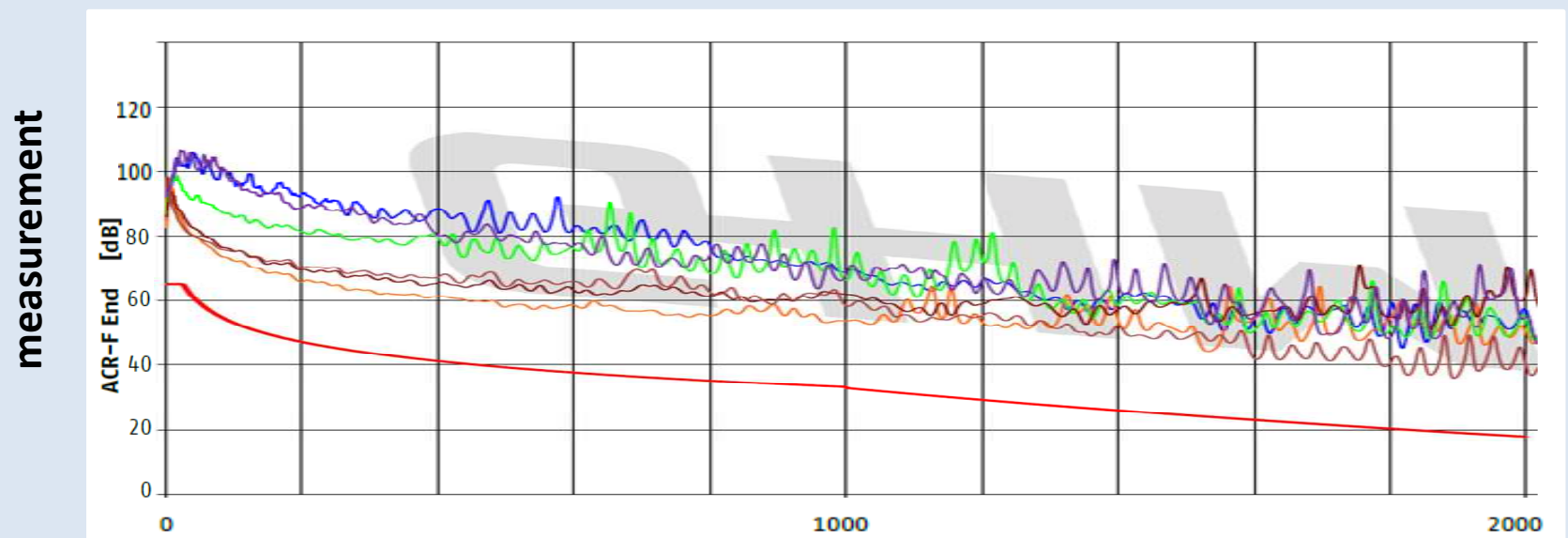
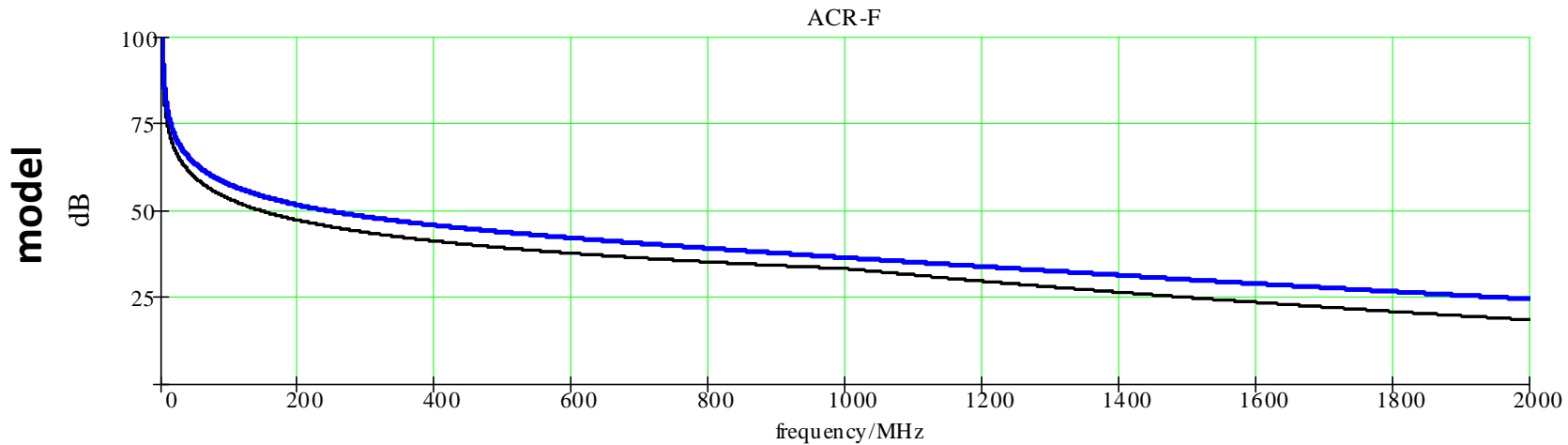

- ISO/IEC 11801-99-1 DTR N 2238 Class I Limits - ISO/IEC 11801-99-1 DTR N 2238 Class II Limits measurements - Model

Conclusions Part 1

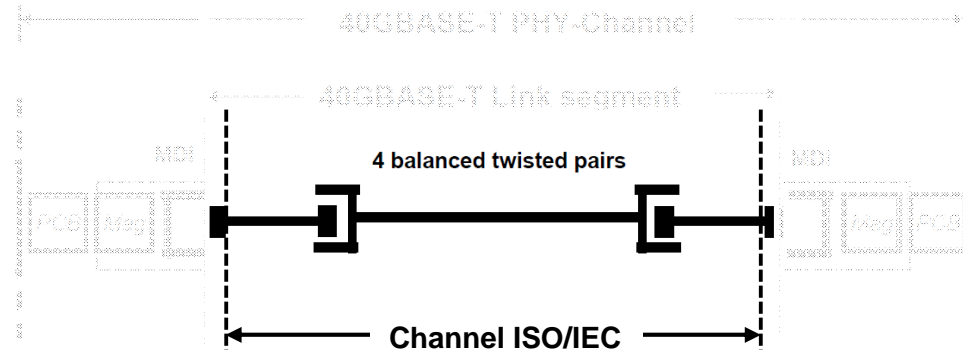

- ISO/IEC model works and mirrors actual measurements
- Up to 1600 MHz the limit lines for RL are sufficient even for very short Class I and Class II channels
- Measurements show capabilities to achieve Class II for short and long channels
- The model can be used to calculate PHY channels

Part 2: Modelling of PHY Channels with touchstone data

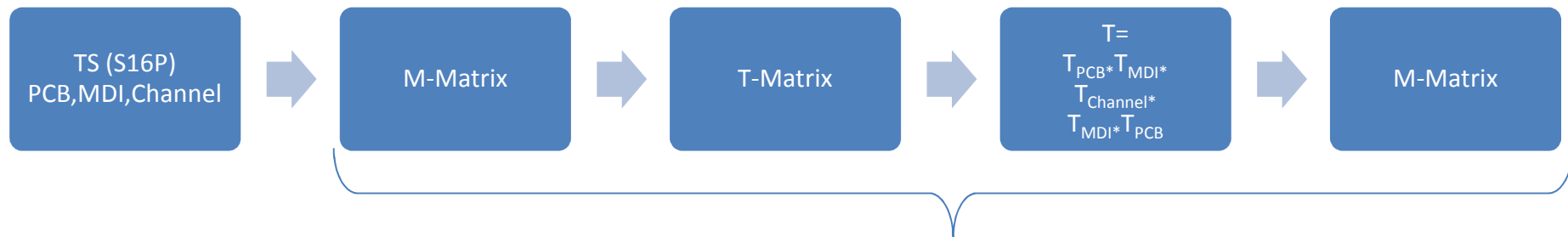
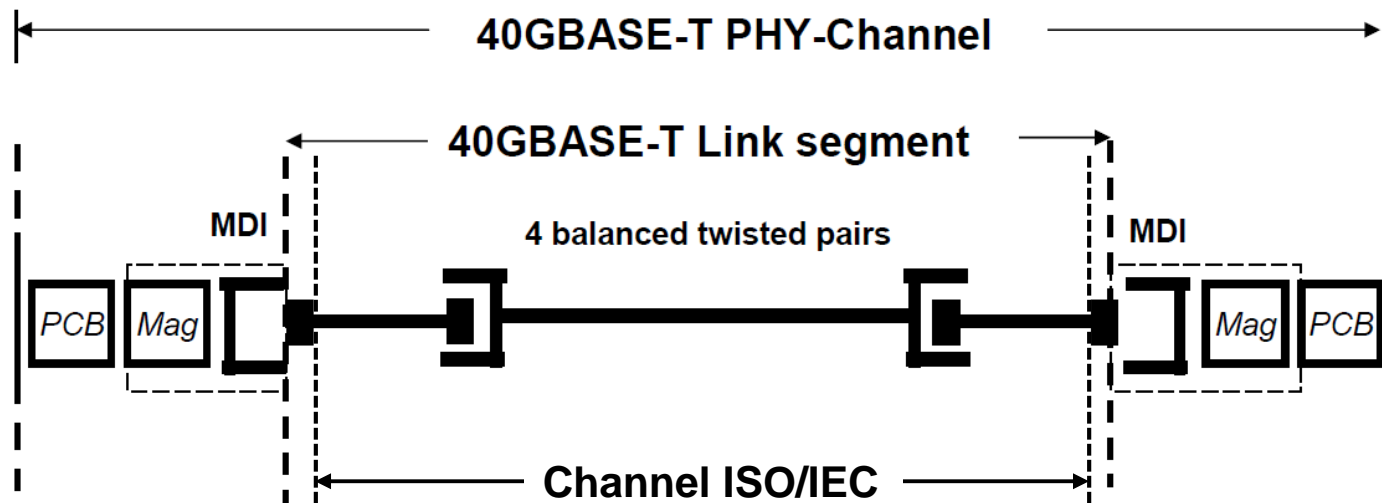

ITG Paper: Impact of the common mode on high data rate transmission over balanced cabling

Part 2: Modelling of PHY Channels with touchstone data

- In a first step 8x8 matrices were processed but 6 cases could be seen for each result

Physical pair pins	Pair naming	Insertion loss pair	Result labelling	NEXT pairs	FEXT pairs	
12	1	1	Case 1	1-2	1-2	
36	2	2	Case 2	2-3	2-3	worst case
45	3	3	Case 3	3-4	3-4	
78	4	4	Case 4	4-1	4-1	best case
78	4	4	Case 5	2-4	2-4	
78	4	4	Case 6	1-3	1-3	

The following Touchstone-Files were used: PCB = Intel
MDI = Bel
Channel = Nexans, Commscope, LEONI

PCB Intel:

(100Ω_3in_25mils)

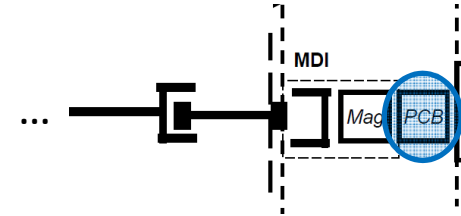

- Case 2: Adjacent microstrip traces (worst case)

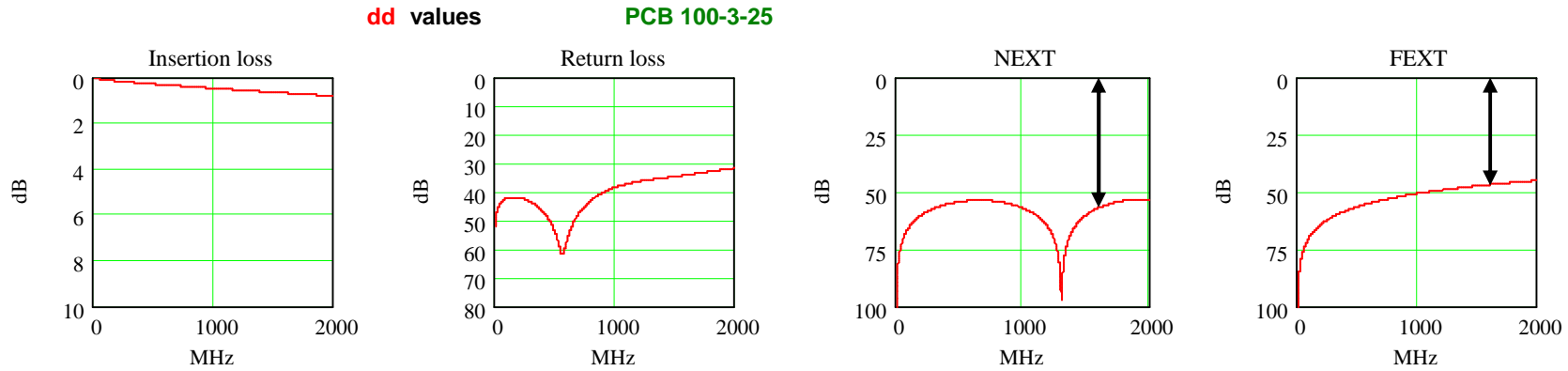

- Case 4: widely separated microstrip traces (best case)

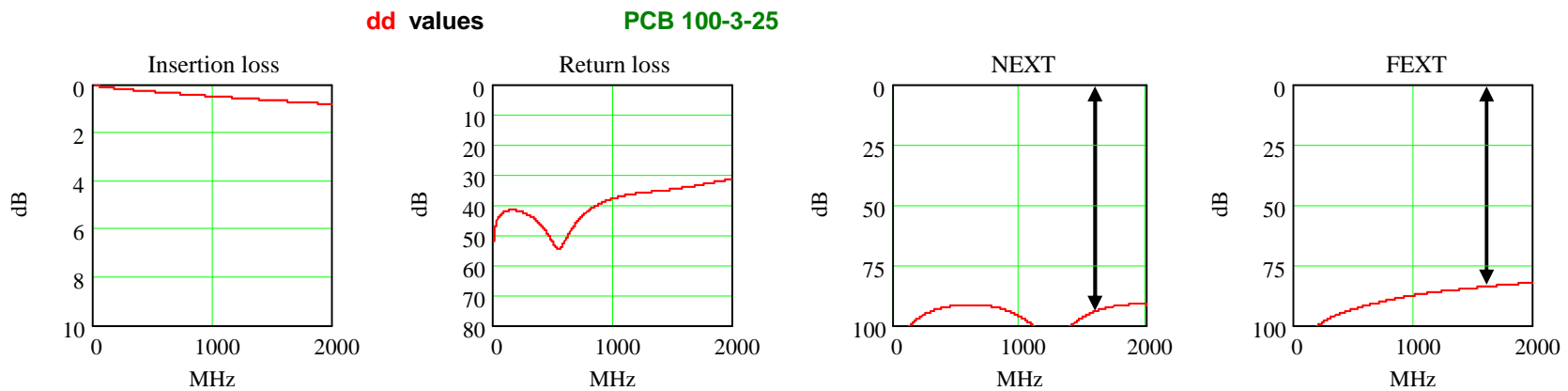

➤ PCB shows good NEXT margins (Case2: 57dB, Case4: 90 dB)@1.6GHz

MDI Bell (RJ45) :

(BellCM2, incl. magnetics)

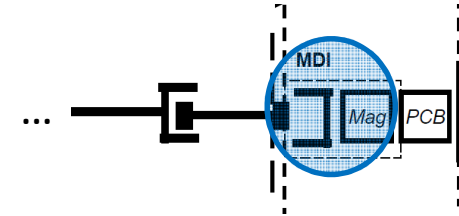

- Case 2: Worst case

dd cc values

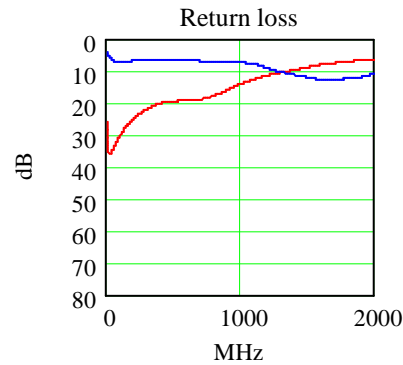
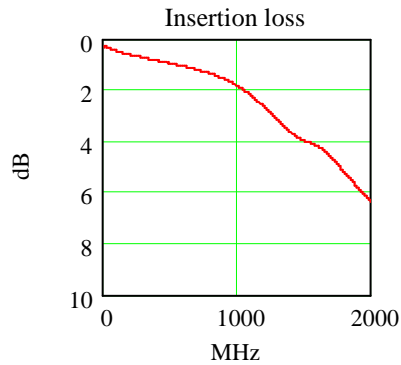

MDI Bell-

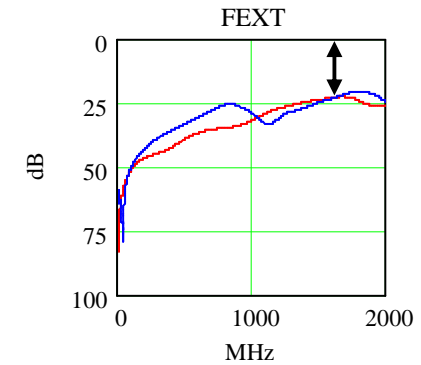
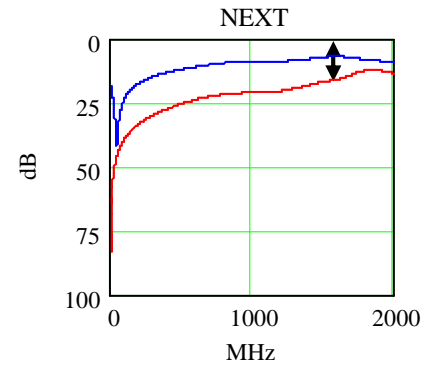

- Case 4: Best case

dd cc values

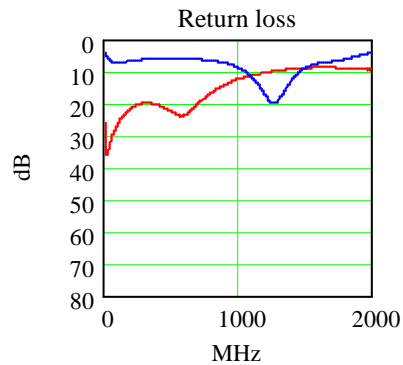
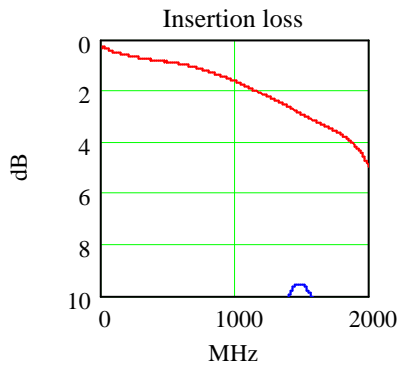

MDI Bell-

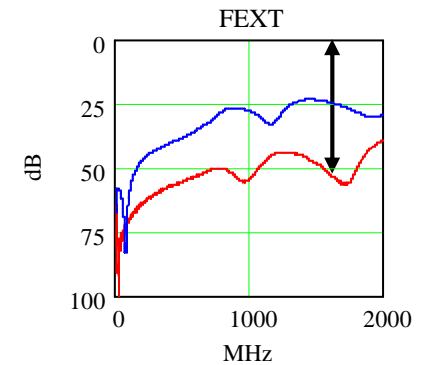
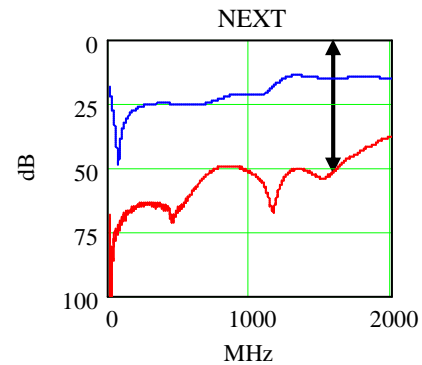

➤ MDI shows significant difference in bad combinations
NEXT margins (Case2: 16dB, Case4: 51 dB)@1.6GHz

Channel Class I Commscope:

long: 3m-24m-3m (11513_3_24_3)

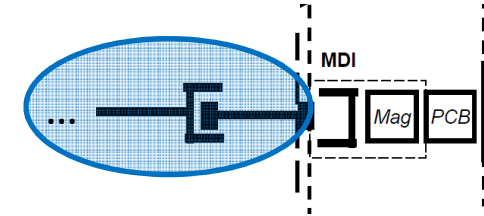

- Case 2: Worst case

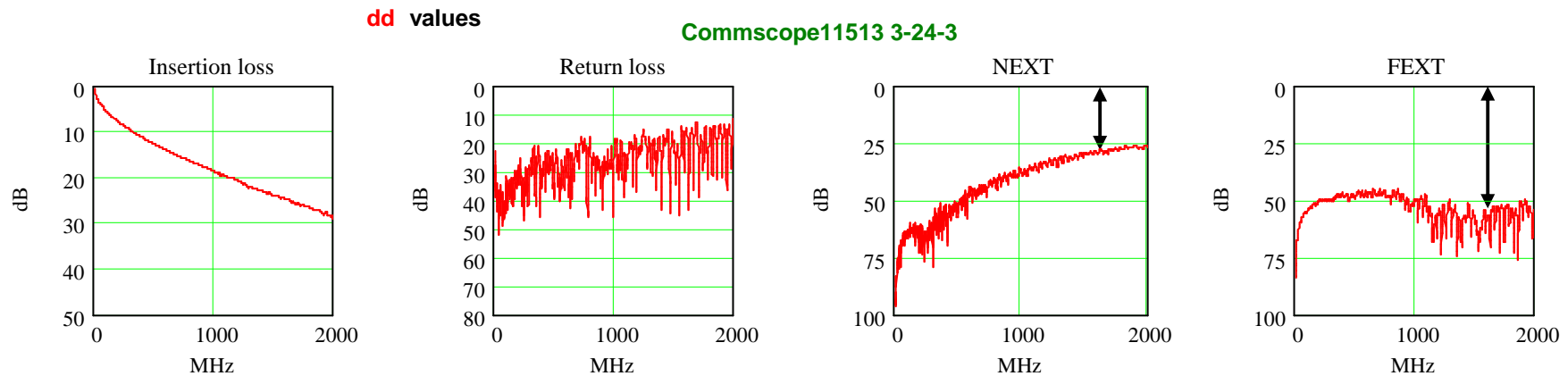

- Case 4: Best case

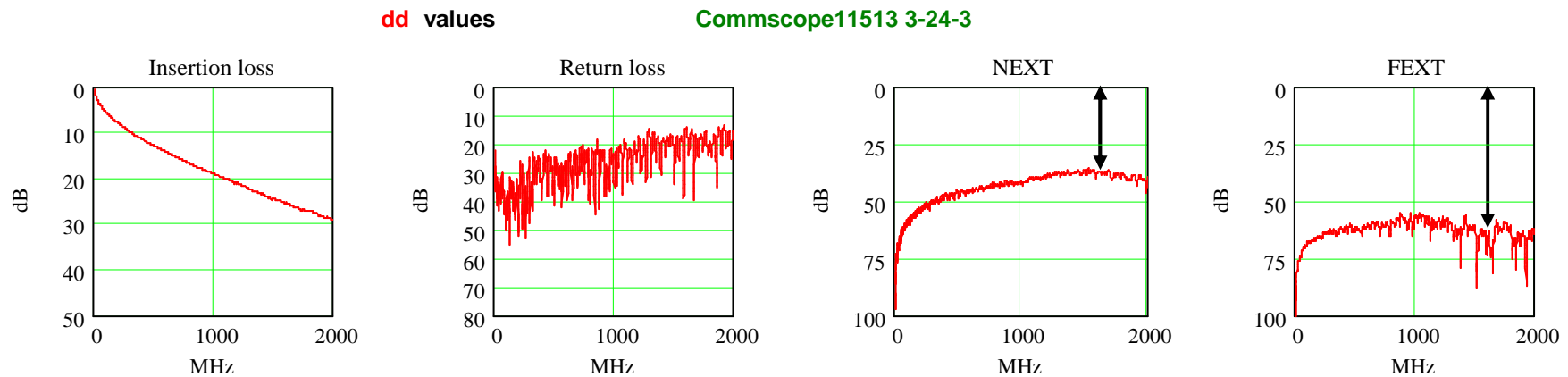

➤ Channel Class I NEXT margin (Case2: ≈ 29 dB, Case4: ≈ 37 dB)@1.6GHz

Channel Class I Commscope + MDI Bell (RJ45) + PCB Intel

long: 3m+24m+3m + MDI_(incl. magnetics)+PCB (100Ω_3in_25mils)

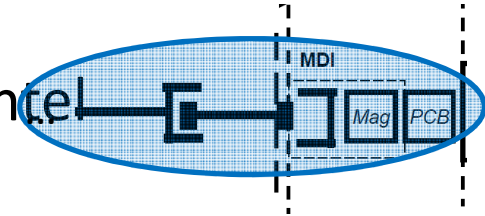

- Case 2: Worst case

dd values PCB 100-3-25 MDI Bell- Commscope11513 3-24-3 MDI Bell- PCB 100-3-25

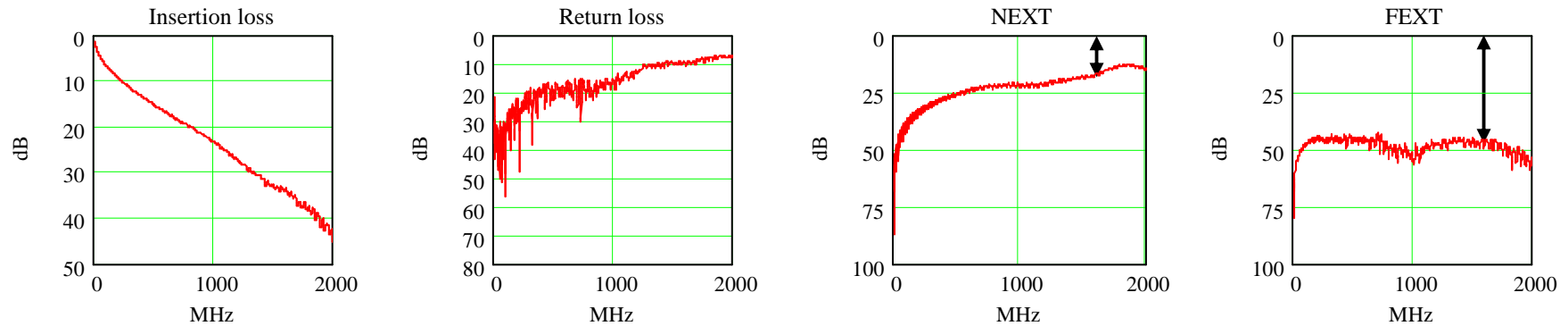

- Case 4: Best case

dd values PCB 100-3-25 MDI Bell- Commscope11513 3-24-3 MDI Bell- PCB 100-3-25

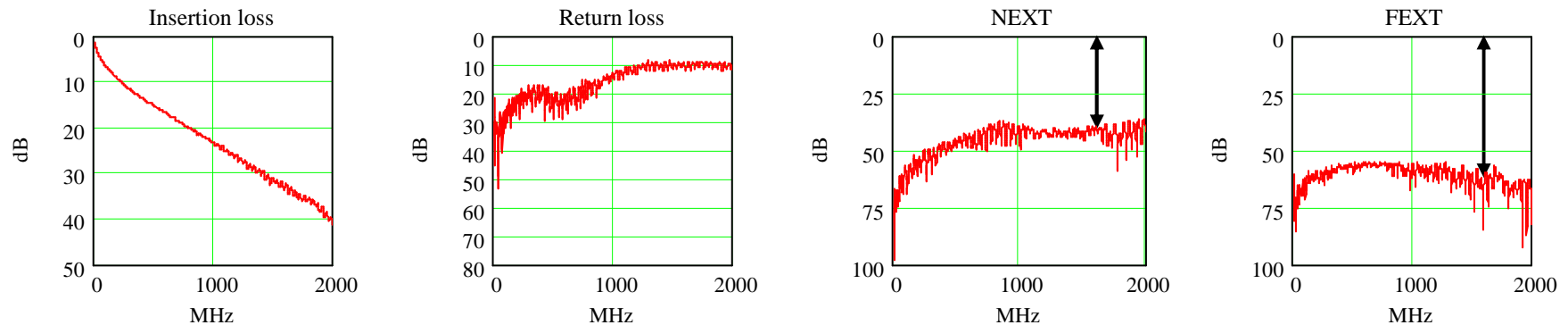

- The magnetics disturb in both cases
- Decreasing NEXT margin (Case2: ~17dB, Case4: ~40 dB)@1.6GHz

Channel Class II Nexans:

long: 3m-24m-3m (3_24_3_Nexans2)

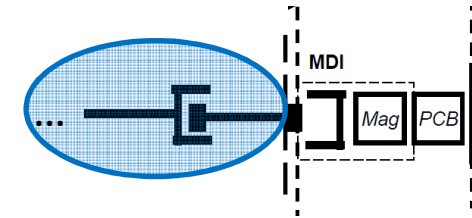

dd values

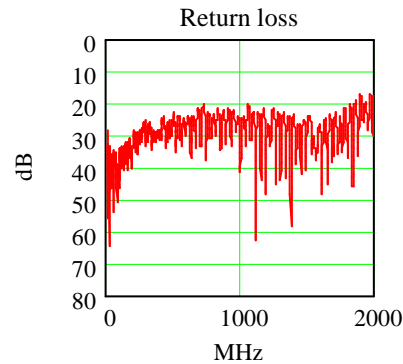
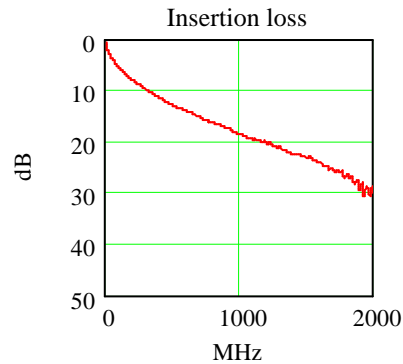

Nexans 30m

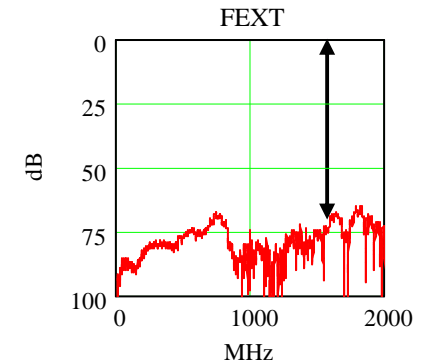
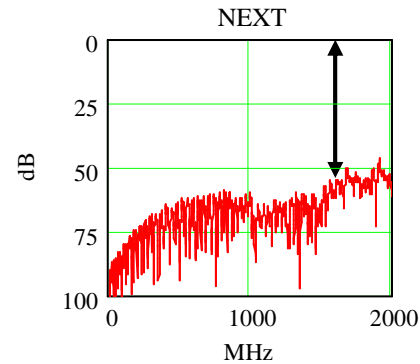

dd values

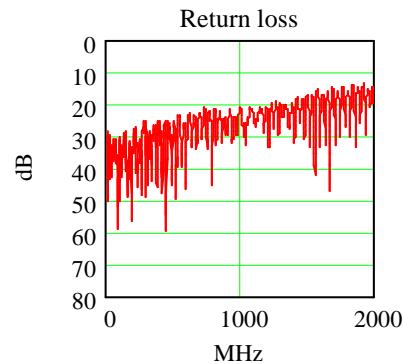
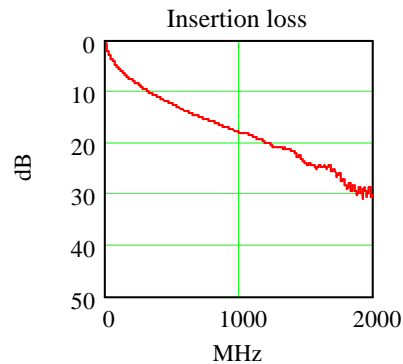

Nexans 30m

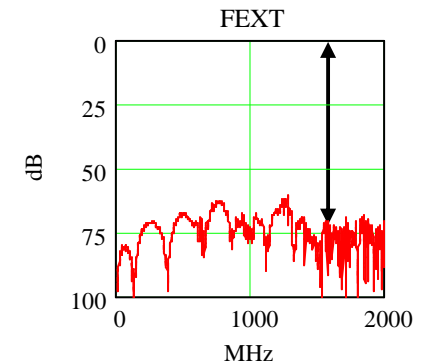
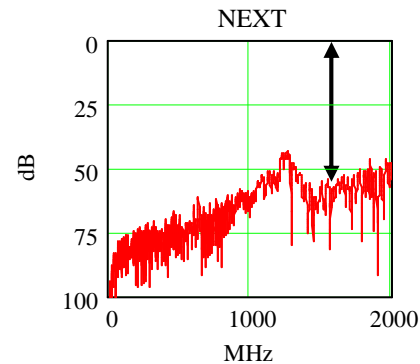

➤ Channel Class II NEXT margins (Case2: 58dB, Case4: 60 dB)@1.6GHz

Channel Class II NexansMDI (non RJ45, w/o Magnetics) + PCB Intel

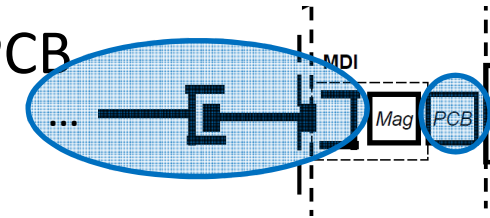

long: 3m+24m+3m_(MDI_3_24_3_MDI_Nexans2) + PCB_(100Ω_3in_25mils)

- Case 2: Worst case

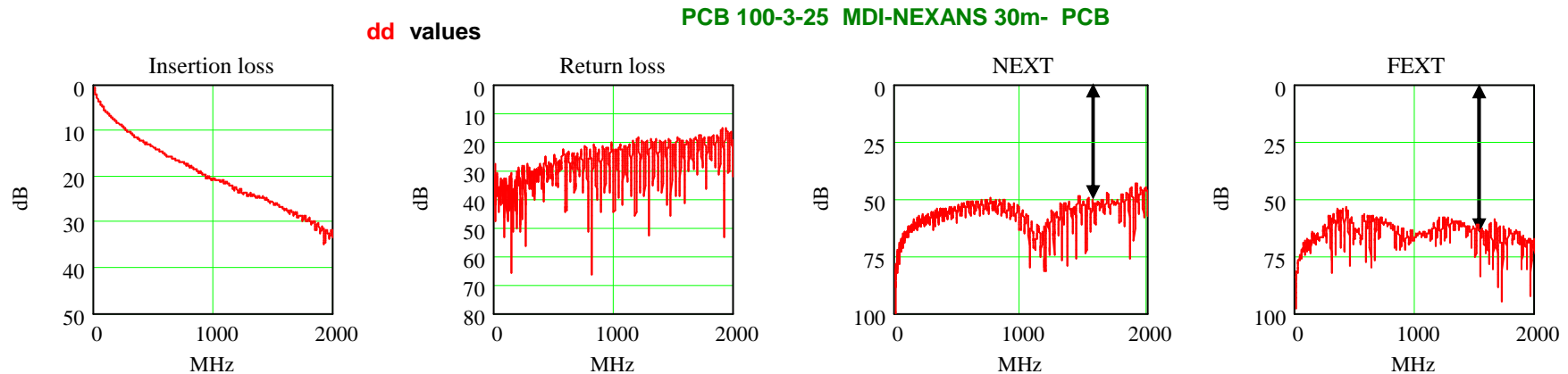

- Case 4: Best case

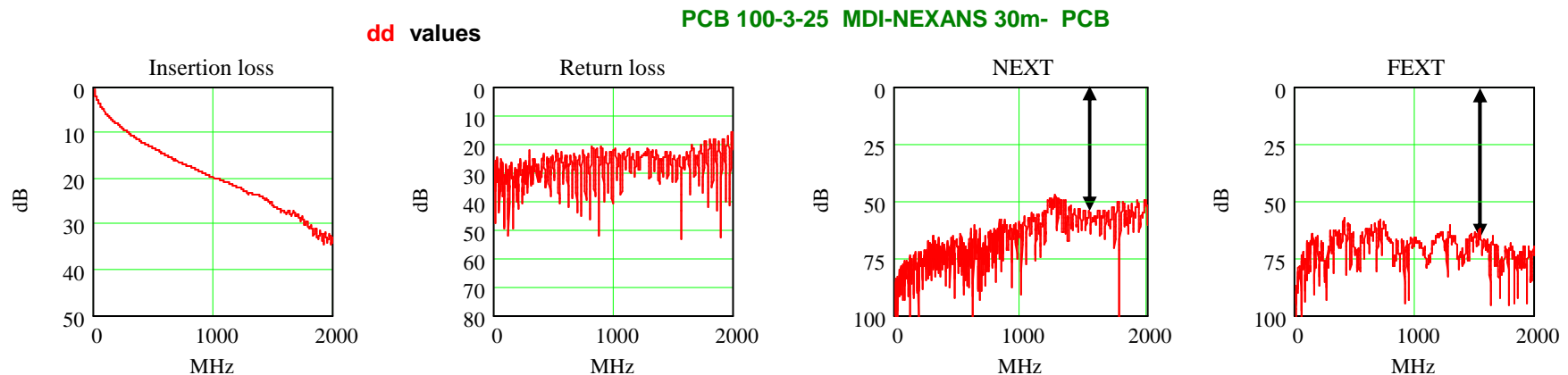

➤ Channel Class II w/o magnetics shows good margins (Case2: 50dB, Case4: 49dB)@1.6GHz

Channel Class II Nexans + MDI Bell (RJ45) + PCB Intel

long: 3m+24m+3m (3_24_3_Nexans2) + MDI_(incl. magnetics) + PCB_(100Ω_3in_25mils)

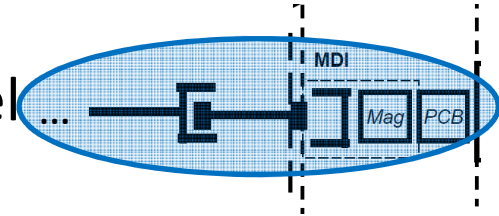

- Case 2: Worst case

dd values

PCB 100-3-25 Bell NEXANS 30m- Bell PCB

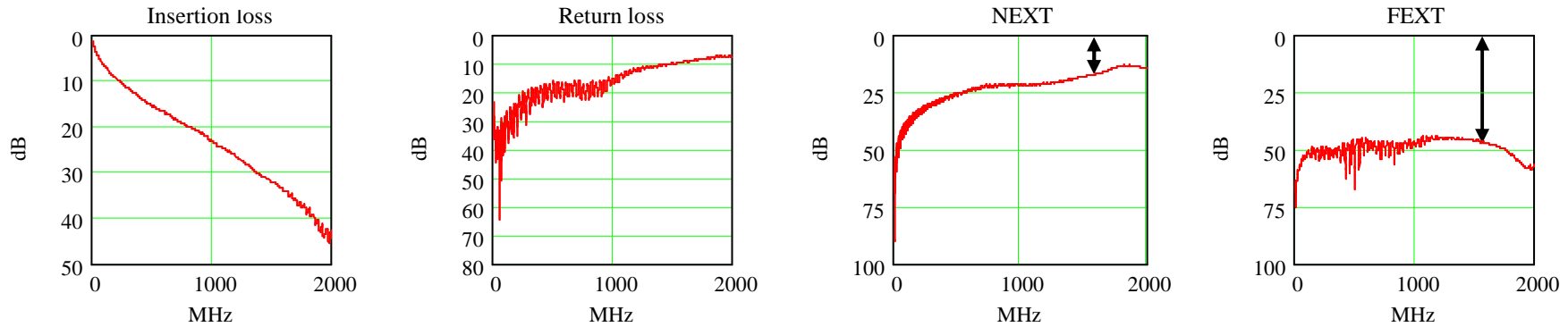

- Case 4: Best case

dd values

PCB 100-3-25 Bell NEXANS 30m- Bell PCB

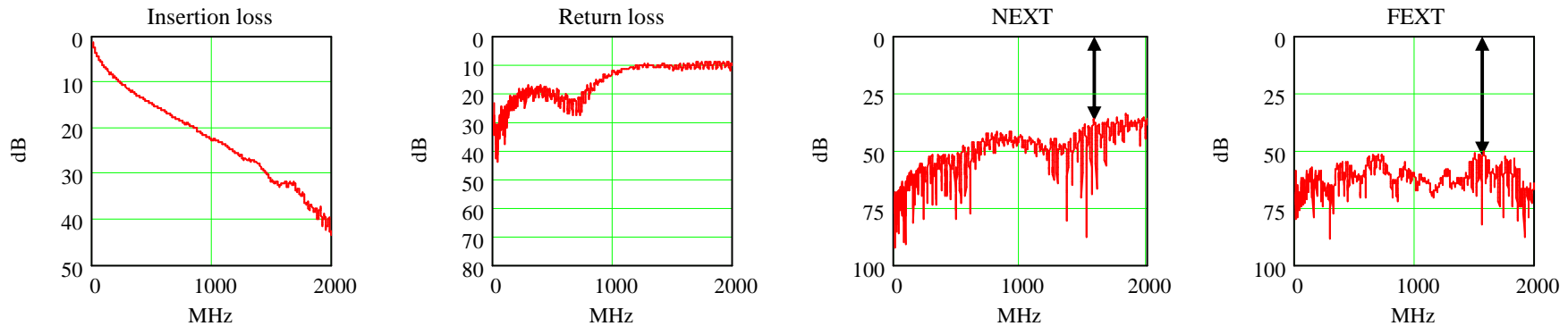

- The magnetics disturb in both cases
- Decreasing NEXT margin (Case2: 17dB, Case4: 42 dB)@1.6GHz

Channel Class II Leoni:

long: 3m-24m-3m

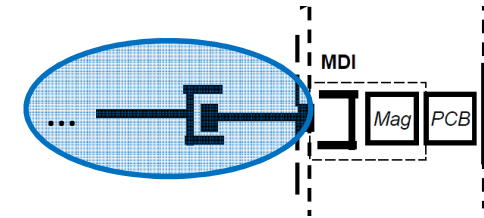

- Case 2: Worst case

dd values Leoni 30m

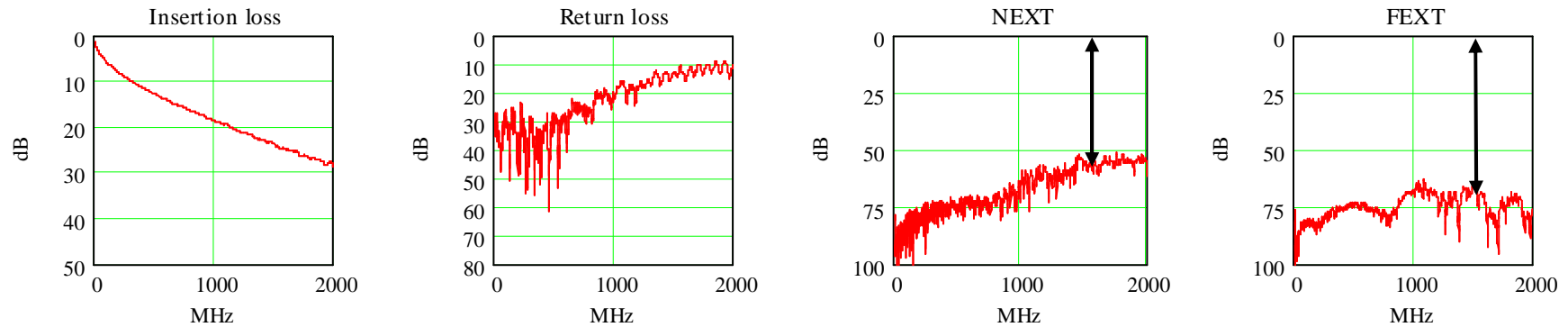

- Case 4: Best case

dd values Leoni 30m

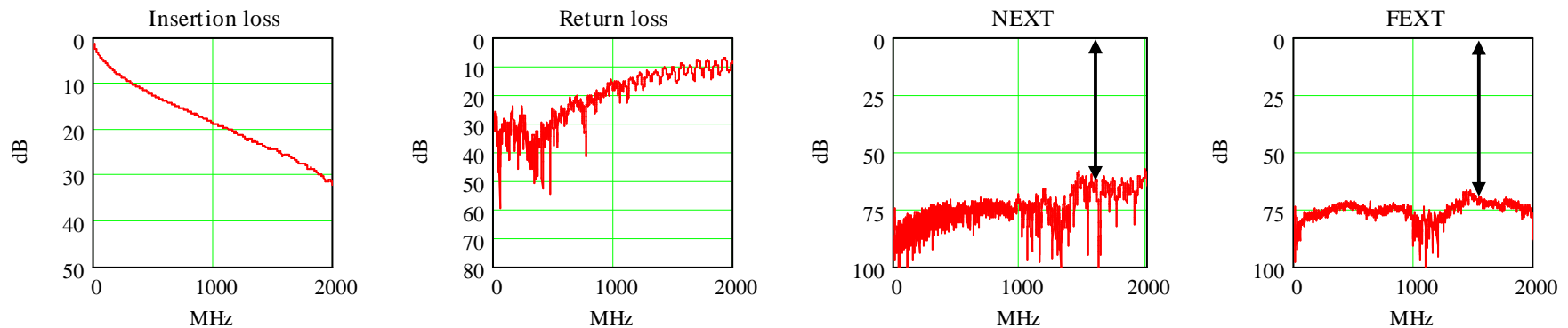

➤ Channel Class I NEXT margin (Case2: 50 dB, Case4: 65 dB)@1.6GHz

Channel Class II Leoni + MDI Bell (RJ45) + PCB Intel

long: 3m+24m+3m + MDI_(incl. magnetics)+PCB (100Ω_3in_25mils)

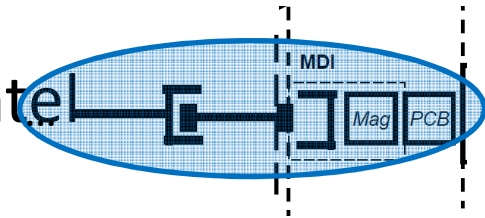

- Case 2: Worst case

dd values PCB 100-3-25 MDI Bell- Leoni 30m MDI Bell-PCB 100-3-25

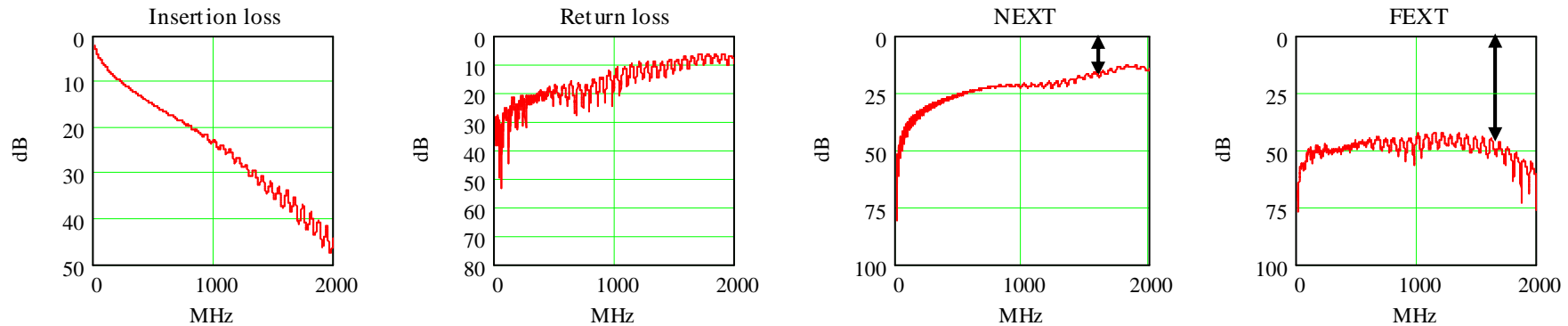

- Case 4: Best case

dd values PCB 100-3-25 MDI Bell- Leoni 30m MDI Bell-PCB 100-3-25

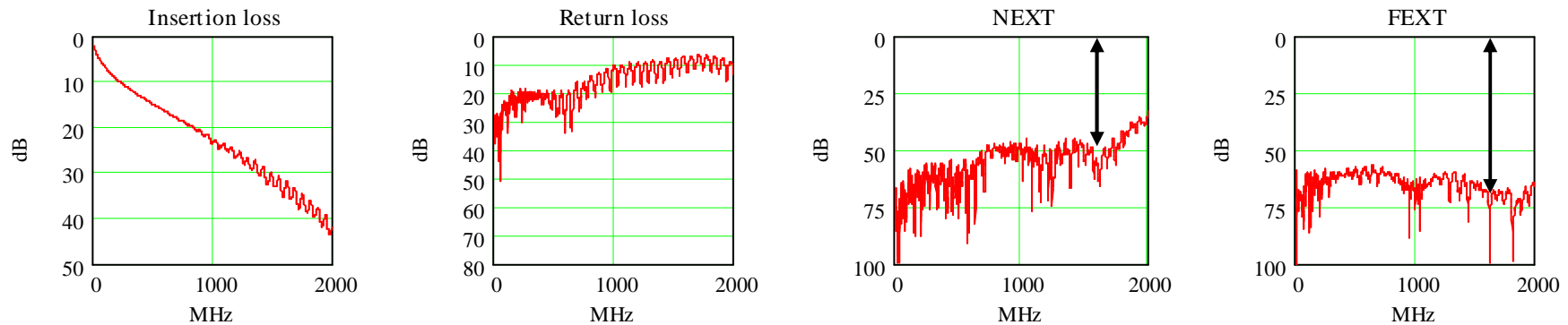

- The magnetics disturb in both cases
- Decreasing NEXT margin (Case2: 17 dB, Case4: 52 dB)@1.6GHz

Summary

- Overview at the frequency 1600MHz
- worst and best cases (worst/best)

	INTEL		Bell	
	NEXT	FEXT	NEXT	FEXT
PCB	57dB/94dB	47dB/84dB		
MDI			16dB/51dB	23dB/53dB

Long Channel	Commscope		Nexans		LEONI	
	NEXT	FEXT	NEXT	FEXT	NEXT	FEXT
Channel	29dB/37dB	58dB/68dB	58dB/60dB	69dB/76dB	50dB/65dB	70dB/76dB
Channel+PCB MDI at channel			50dB/49dB	50dB/47dB		
Channel+MDI+PCB	17dB/40dB	48dB/60dB	17dB/42dB	47dB/59dB	17dB/52dB	48dB/70dB

Conclusion Part 2

- PCB layout
 - The chosen layout (3inch - 25mils) has already good transmission performance and does not derate the cabling performance. But short length is unrealistic.
 - The model can be used for the required length of traces
 - It is important to choose a layout that does not derate the cabling performance
- Magnetics on MDI
 - The presented cases demonstrate some very good pair combinations results and some “not so good” pair combination results.
 - At the moment the magnetics reduce the cabling channels dramatically even for class I
- Channel II configurations shows more NEXT & FEXT margin than channel I configurations
- The model can be used to assess the impact (for all parameters) of new components/future improvement for MDI and/or PCB

Thank you

Any questions?