



Test Data: Transmission Characteristics of Channels utilizing ARJ45 Connectors

Richard Marowsky
rmarowsky@stwconn.com
Yakov Belopolsky
ybelopolsky@stwconn.com

*IEEE P802.3bq 40GBASE-T Task Force
Beijing, PRC, March 2014*

Test Data: Transmission Characteristics of Channels utilizing ARJ45 Connectors

Abstract

This technical contribution in support of IEEE 802.3bq 40GbE standard development provides test data for copper cable channels utilizing the IEC 61076-3-110 standard connectors ARJ45. In order to provide comparison with other connectivity options the data includes 2-26-2 m channel. Also a longer 50 m channel 2-46-2 was constructed and measured . Testing was done in 2 GHz and 3 GHz spectra. Data demonstrated significant improvement in RL (10 to 12 dB) and NEXT (up to 30 dB). The ARJ45 connectors are based on electrical isolation resulting in the improved channel transmission performance. It is expected that would reduce the PHY complexity and accelerate implementation of 40 GbE technology. The adoption of the IEC 61076-3-110 connectivity by IEEE would result in more robust transmission performance, wider utilization of 40GBASET and smooth transition to 40 GbE and beyond copper-based Ethernet

STANDARD CONNECTOR INTERFACES

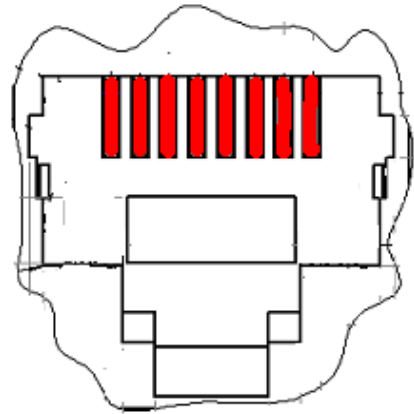

IEC 60603-7
RJ45

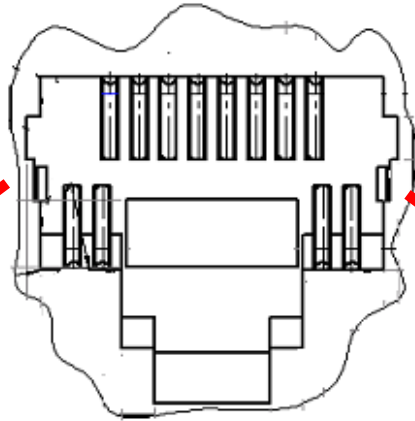

IEC 60603-7-71
contains a switch
GG45 or S-RJ45

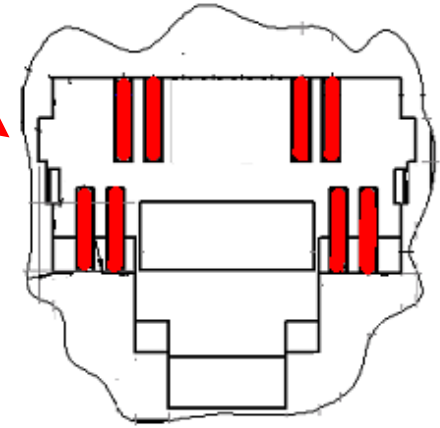

IEC 61076-3-110
ARJ45

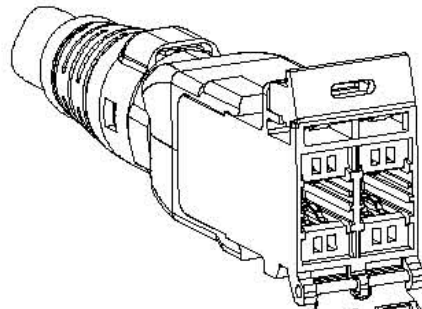

IEC 61076-3-104

STANDARD CONNECTOR INTERFACES

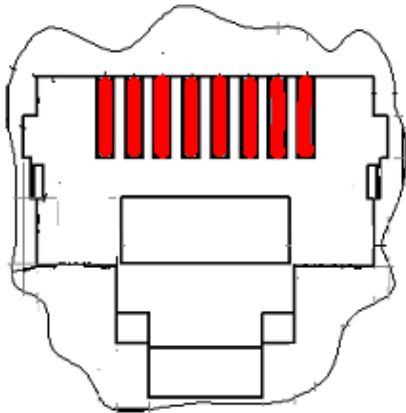

IEC 60603-7

RJ45

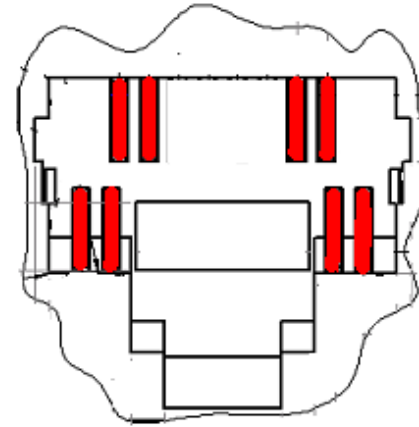

IEC 61076-3-110

ARJ45

ARJ45 interface derived from RJ45

THE FORM FACTOR of RJ45 and ARJ45 is the same

RJ45 requires **compensation** to improve transmission characteristics

ARJ45 utilize **isolation** to meet and exceed the requirements

IEC 61076-3-110 connector examples



PCB JACKS

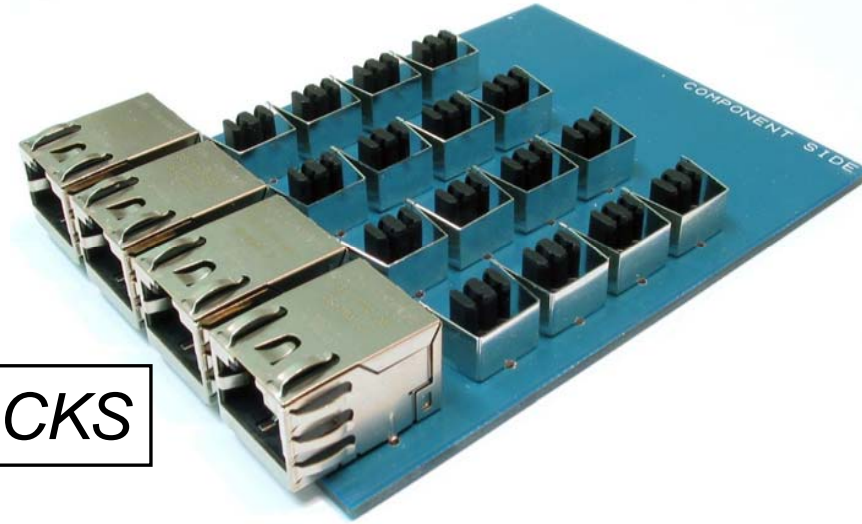

Coupler Jack

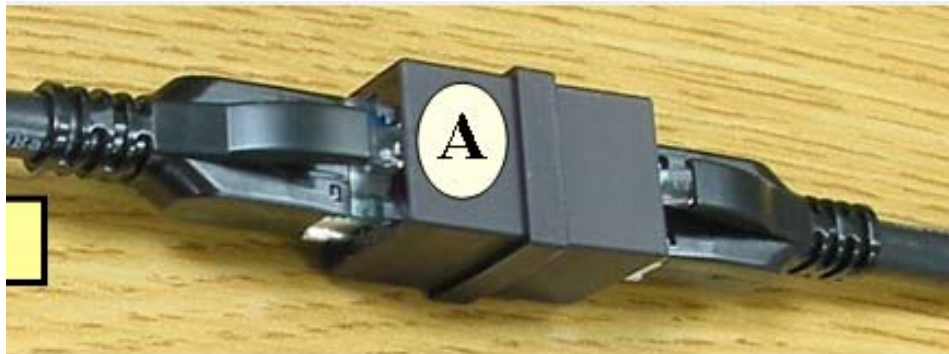

Rationale: To help to alleviate some concerns and make copper channel option more appealing to wider application environment

Concerns

- RJ45 connectivity may not provide enough safety margin for robust implementation
- Length of copper cabling (30 m) may not address some applications
- Copper channels can provide only marginal transmission performance
- More complex PHY and DSP would be needed to compensate for marginal transmission abilities of copper
- 40GbE may have higher power consumption requirements

30 meter Channel Configuration ARJ45 Connectivity 2 GHz Bandwidth

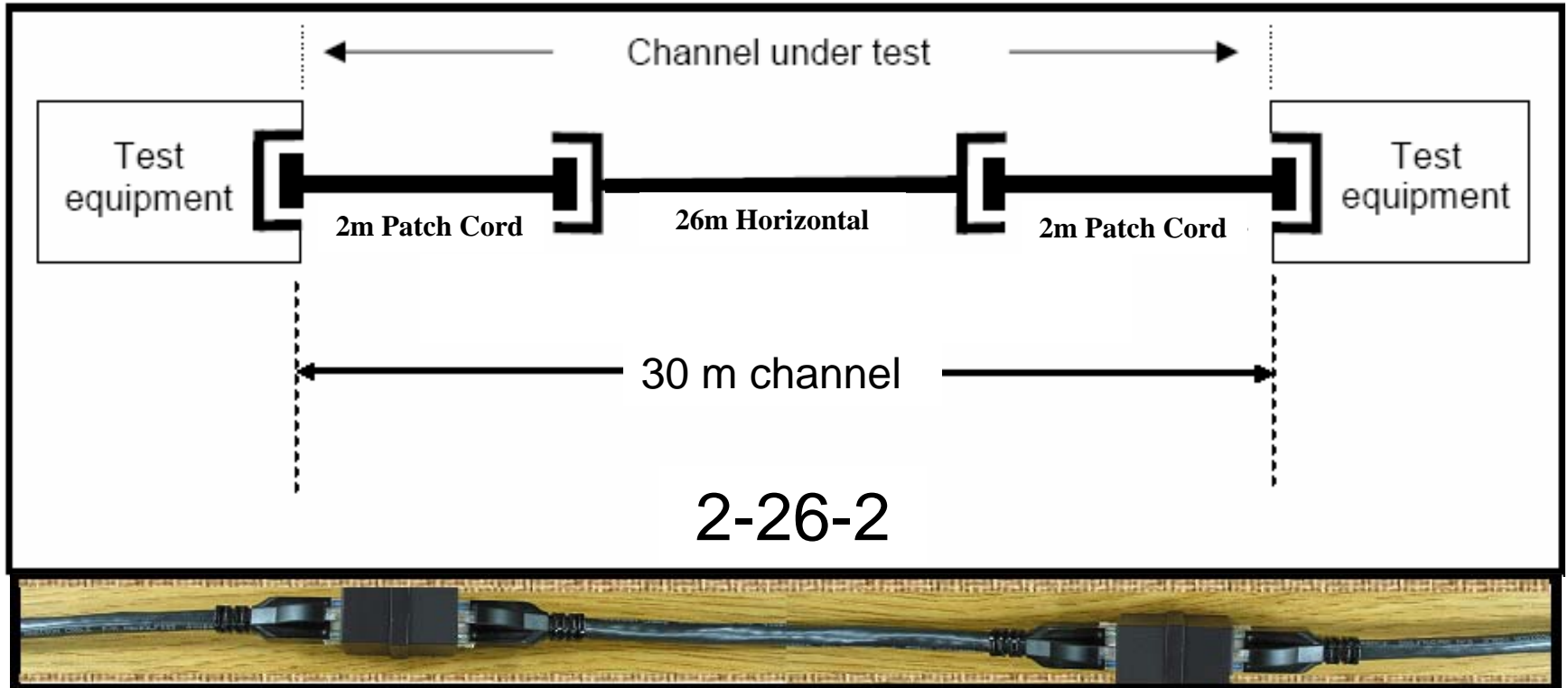

Channel Data Collected w/ Field Network Analyzer manufactured by Psiber Data

2-26-2 Channel IL

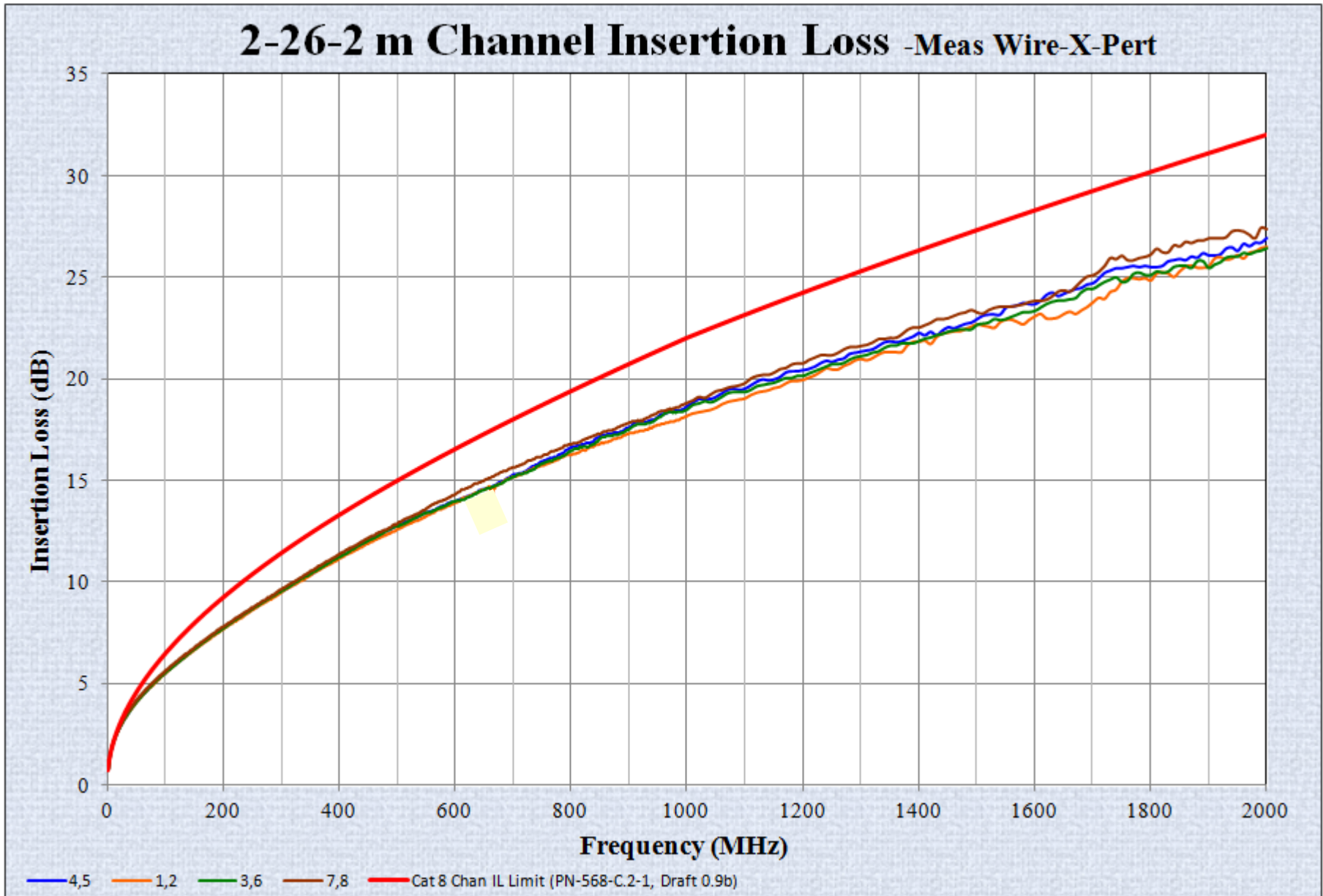

2-26-2 Channel Return Loss

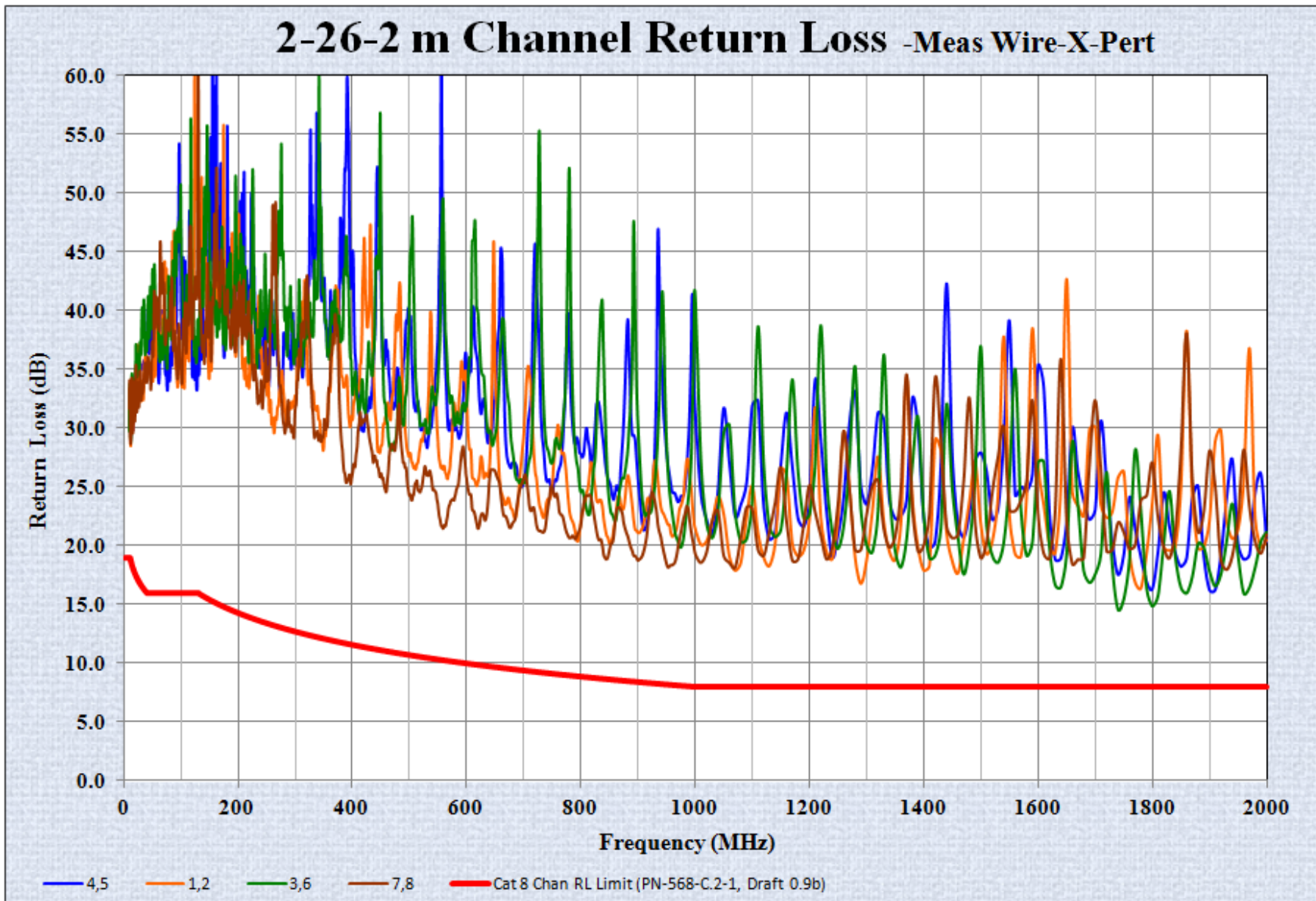

2-26-2 Channel NEXT

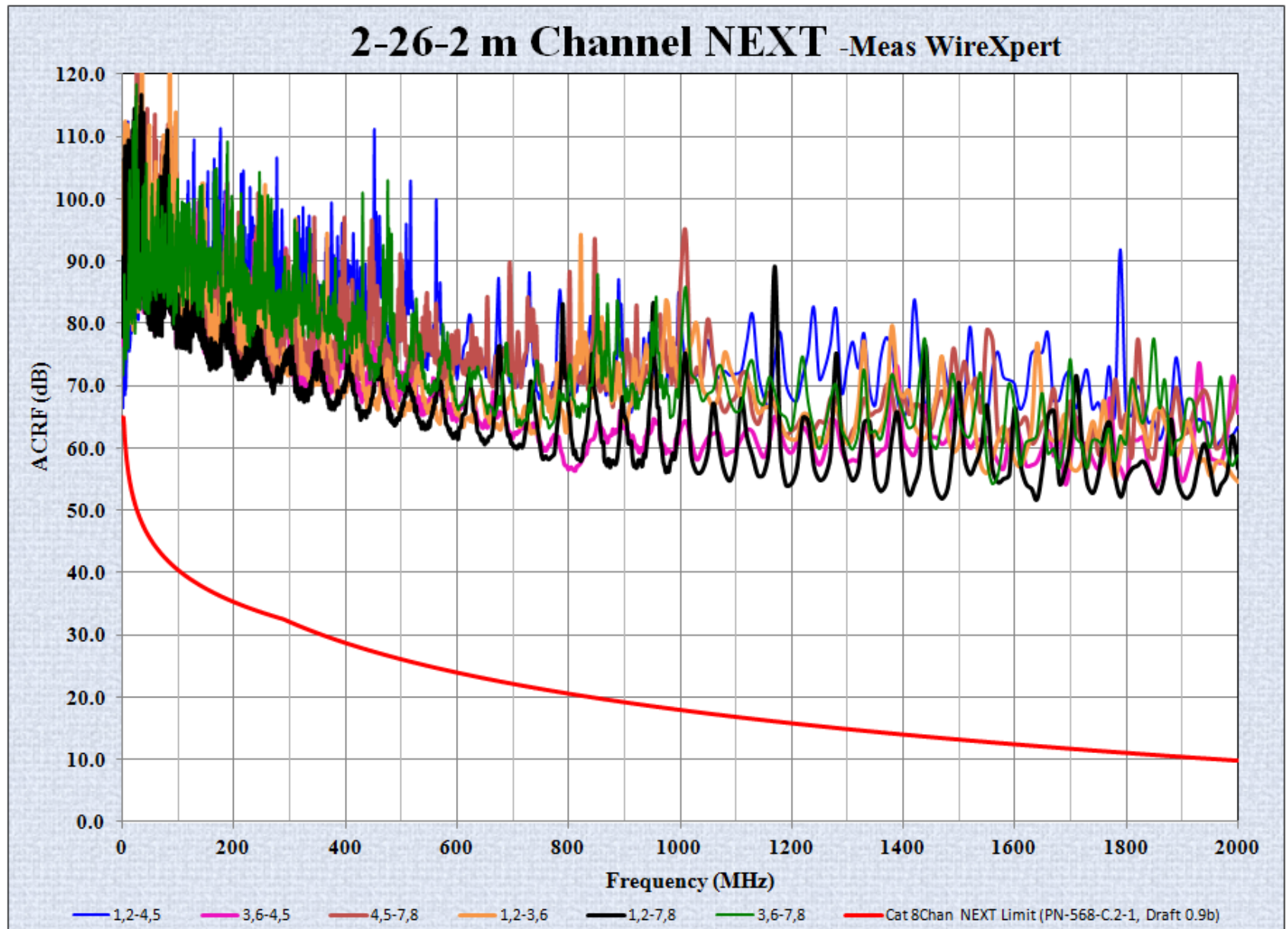

50 meter channel configuration

ARJ45 connectivity - 3GHz bandwidth

- Measurements Performed on 50 meter, 2-Connector Channel
- 2m Patch Cords, 46m Horizontal
- TIA 1183 Balun-Less Measurement Method w/Alternative Fixturing

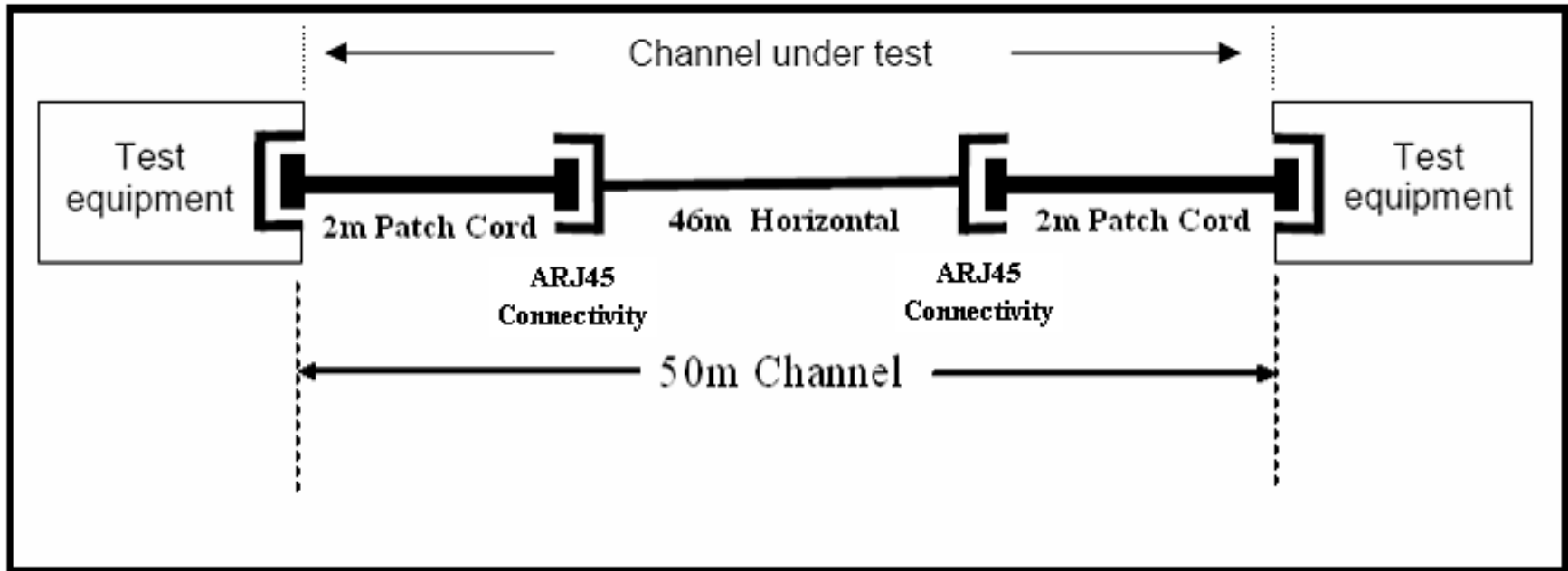

2-46-2 ARJ45 CHANNEL NEXT

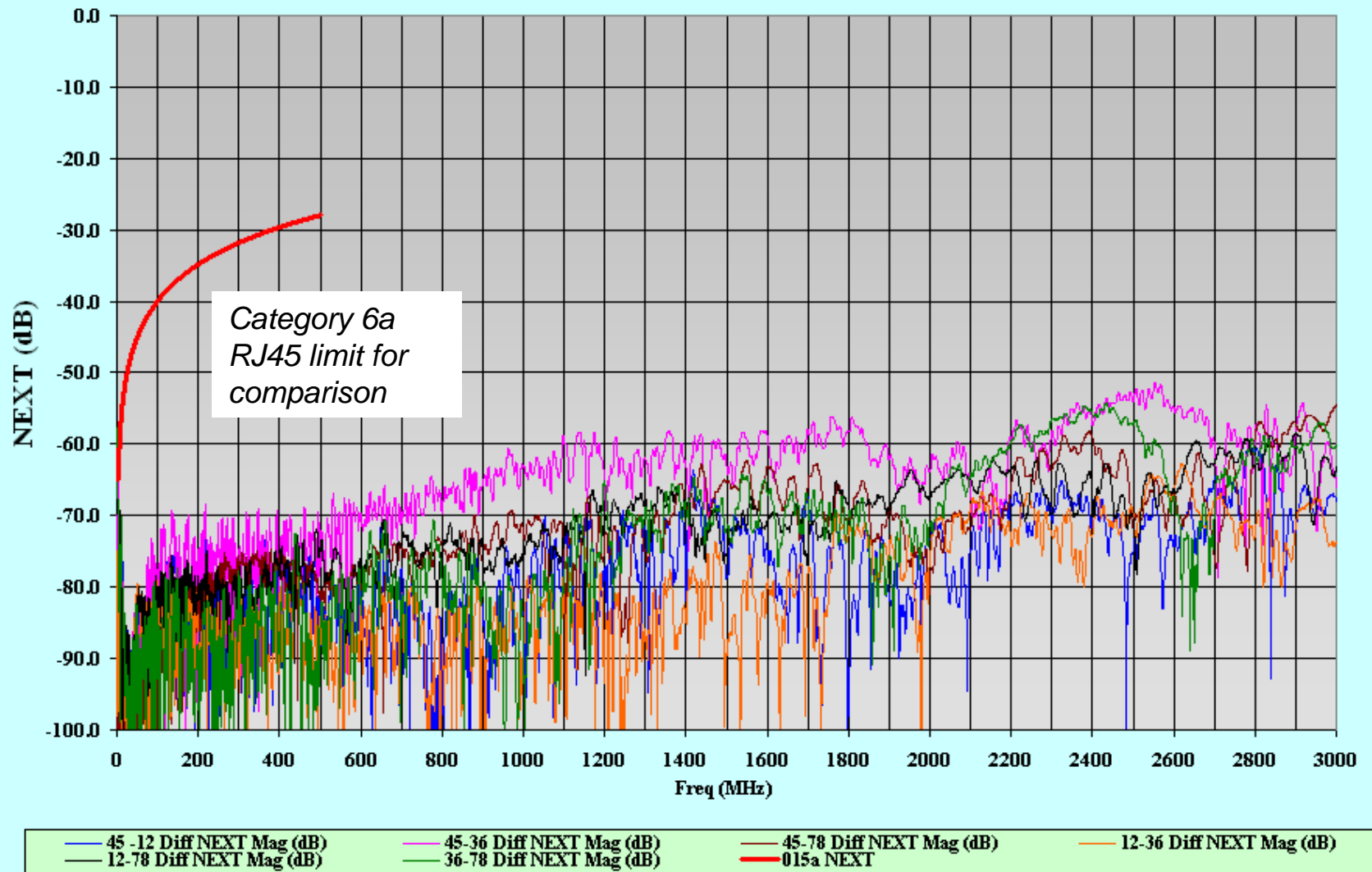

2-46-2 ARJ45 CHANNEL RETURN LOSS

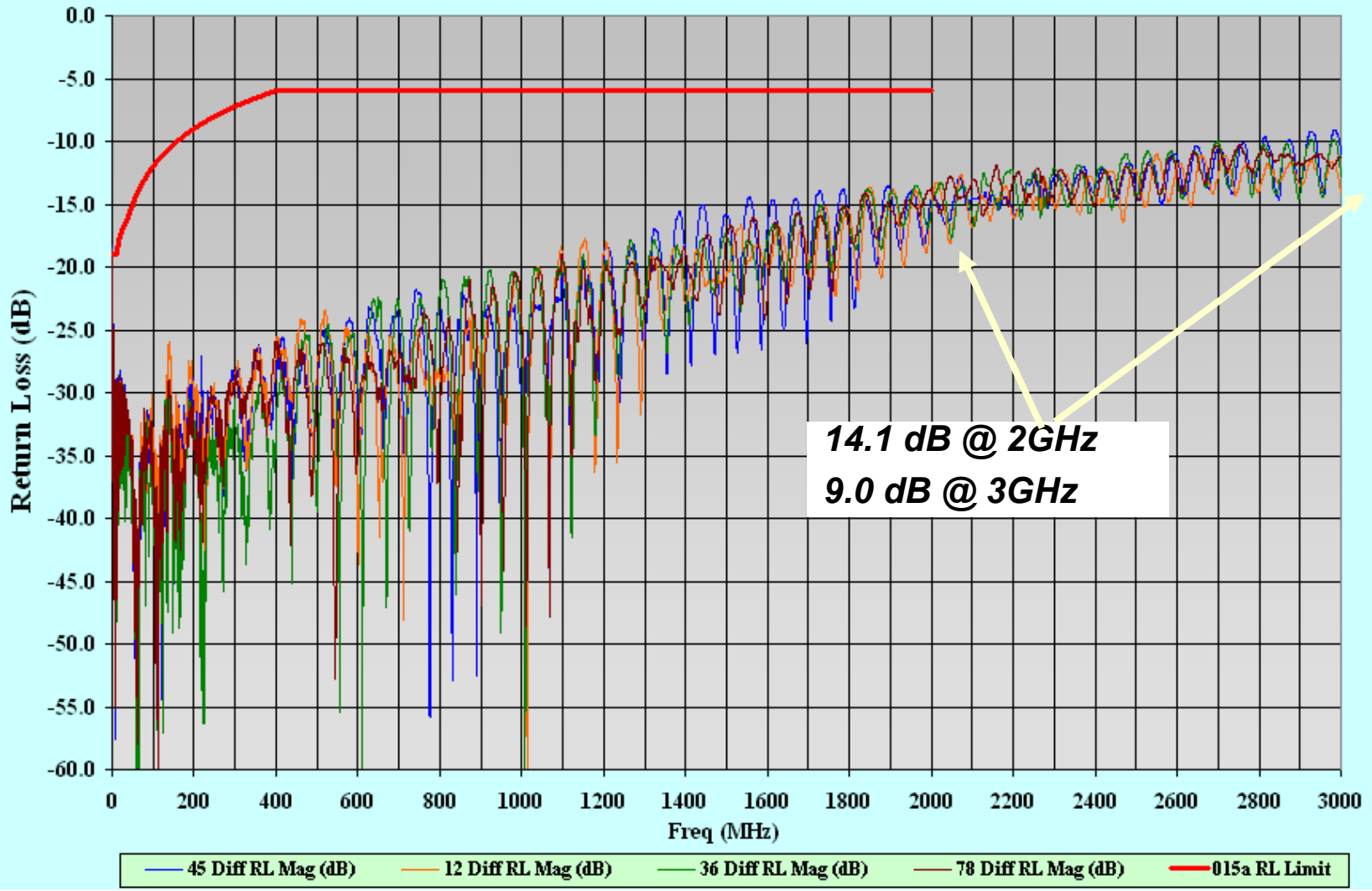

2-46-2 ARJ45 CHANNEL TcL

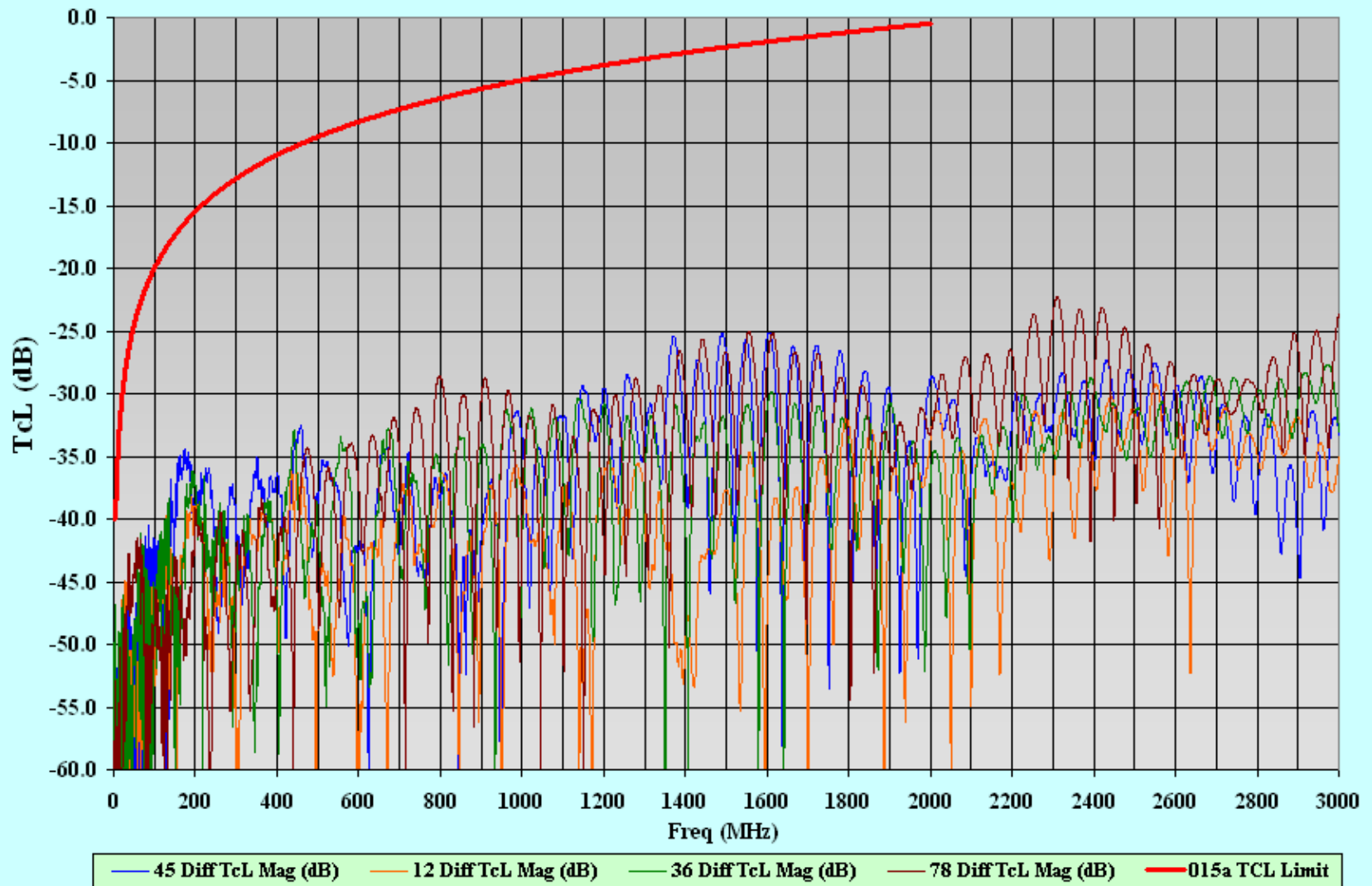

Measurement Data Summary

II

50 meter CHANNEL 0 to 3GHz bandwidth

The comparative performance data was not available

The test results in absolute values for 50 m channel

ABSOLUTE VALUE , worst case

	<i>0 to 500 MHz</i>	<i>501 to 2000 MHz</i>	<i>2001 to 3000 MHz</i>
<i>NEXT</i>	63 dB	57 db	52 db
<i>Return loss</i>	23 dB	14 dB	9 dB
<i>TCL</i>	33 dB	26 dB	23 dB

SUMMARY

- 1. Test Data demonstrated** that 30m channel based on IEC 61076-3-110 ARJ45 connectivity provides better RL, NEXT and TcL (in reference to other options)
- 2. Test Data demonstrated** that the 50m channel based on IEC 61076-3-110 ARJ45 connectivity is feasible to support 40 GbE
- 3. Test Data suggests** that the adoption of the IEC 61076-3-110 connectivity by IEEE would result
 - ▶ in more robust transmission performance,
 - ▶ wider utilization of 40GBASET
 - ▶ smooth transition to 40 GbE and beyond copper-based Ethernet