

Agenda and General Information

IEEE P802.3bq 25G/40GBASE-T Task Force

David Chalupsky, Intel

Bonita Springs, Florida, USA
September, 2015

Agenda

- Welcome and Introductions
- Approve Agenda
- Approve minutes from last meeting
- Goals for this meeting
- Big Ticket Items
- Reflector and Web
- Ground Rules
- IEEE
 - Structure, Bylaws and Rules
 - Call for Patents
 - IEEE Standards Process
- Liaisons and Communications
- Presentations and comment resolution
- Motions and Closing Business
- Future Meetings

Motion #1

- Approve the agenda
- M:J Lewis
- 2nd:P Cibula
- (Procedural $\geq 50\%$)
- Result: PBVVWO



Motion #2

- Approve the minutes from the July, 2015 P802.3bq and 25GBASE-T SG joint meeting.
- M:JLewis
- 2nd:Gzimmerman
- (Procedural $\geq 50\%$)
- Result: PBVVWO

Task Force Decorum



- Press (i.e., anyone reporting publicly on this meeting) are to announce their presence (December 2013 IEEE-SA Standards Board Ops Manual 5.3.3.5)
- Photography or recording by permission only (December 2013 IEEE-SA Standards Board Ops Manual 5.3.3.4)
- Cell phone ringers off
- Wear your badges at all times in meeting areas
 - Help the hotel security staff improve the general security of the meeting rooms
 - **PCs HAVE BEEN STOLEN** at previous meetings
 - **DO NOT** assume that meeting areas are secure
- Please observe proper decorum in meetings

IEEE P802.3bq 25G/40GBASE-T Task Force Project Information

- Task Force Organization
 - David Chalupsky, Chair
 - George Zimmerman, Chief Editor, PHY Proposal ad hoc chair
 - Editorial team: Chris DiMinico, Valerie Maguire, Curtis Donahue, Jim Graba
 - Pete Cibula, Chair, Rx CMNR ad hoc
 - Jon Lewis, Secretary
- Task force web and reflector information
 - Reflector information: <http://www.ieee802.org/3/NGBASET/reflector.html>
Home page: <http://ieee802.org/3/bq/index.html>
 - PAR <http://www.ieee802.org/3/bq/P802.3bq.pdf>
 - CSD <https://mentor.ieee.org/802-ec/dcn/15/ec-15-0069-00-ACSD-802-3bq.pdf>
 - Objectives http://www.ieee802.org/3/bq/P802.3bq_modified_objectives.pdf
 - Adopted timeline: ???
 - Private area: <http://ieee802.org/3/bq/private/index.html>
 - Username:xxxxxxxx
 - Password: xxxxxxxxxxx
 - Note: The draft, and any other content, is posted for your review only, and neither the content nor access information should be copied or redistributed to others in violation of document copyrights

P802.3bq 25G/40GBASE-T Objectives



Approved
by 802.3
March '15

- Support full duplex operation only
- Preserve the 802.3 / Ethernet frame format utilizing the 802.3 MAC
- Preserve minimum and maximum Frame Size of current 802.3 standard
- Support a BER better than or equal to 10^{-12} at the MAC/PLS service interface
- Support Auto-Negotiation (Clause 28)
- Support Energy Efficient Ethernet (Clause 78)
- Support local area networks using point-to-point links over structured cabling topologies, including directly connected link segments
- Do not preclude meeting FCC and CISPR EMC requirements
- Support a data rate of 40 Gb/s at the MAC/PLS Service Interface
- ❖ Support a data rate of 25 Gb/s at the MAC/PLS Service Interface
- Define a link segment based upon copper media specified by ISO/IEC JTC1/SC25/WG3 and TIA TR42.7 meeting the following characteristics:
 - 4-pair, balanced twisted-pair copper cabling
 - up to 2 connectors
 - up to at least 30 m
- Define a single 40 Gb/s PHY supporting operation on the link segment
- ❖ Define a single 25 Gb/s PHY supporting operation on the link segment

❖ Adopted by the 25GBASE-T Study Group, January 14, 2015

IEEE P802.3bq Potential Timeline with 25GBASE-T

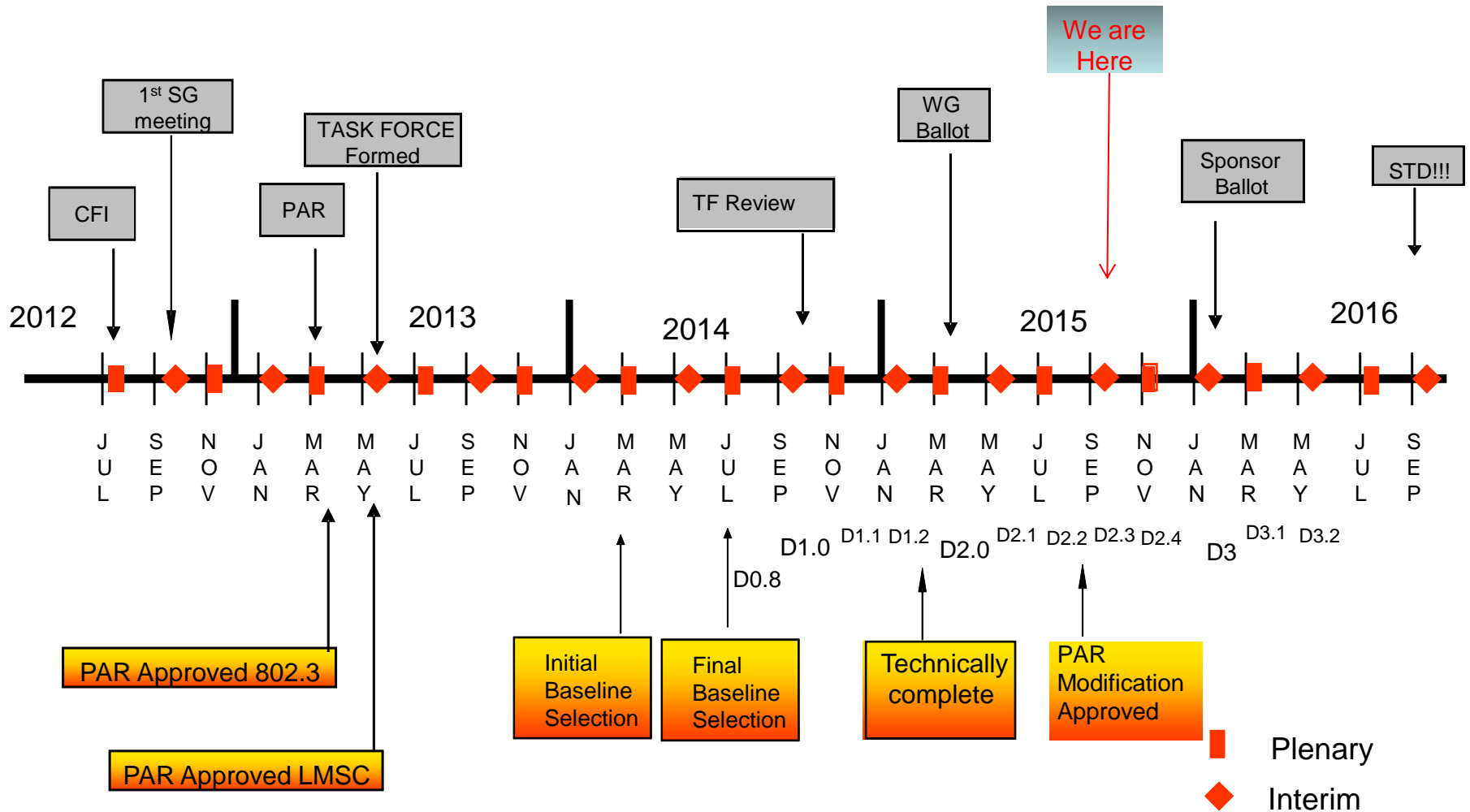

Ground Rules

- Based upon IEEE 802.3 Rules
 - Foundation based upon Robert's Rules of Order
 - Anyone in the room may speak
 - Anyone in the room may vote
- **RESPECT**... give it, get it
- NO product pitches
- NO corporate pitches
- NO prices!!!
 - This includes costs, ASPs, etc. no matter what the currency
- NO restrictive notices

Attendance

- Tutorial Material on attendance tool
 - http://ieee802.org/3/minutes/attendance_procedures.pdf
- Access details
 - URL: <http://imat.ieee.org/>
 - Pw =
 - Please sign the P802.3bq/bz attendance book that will be circulated each day
 - IMAT records attendance for 802.3 records
 - Our book records for minutes

IEEE Structure

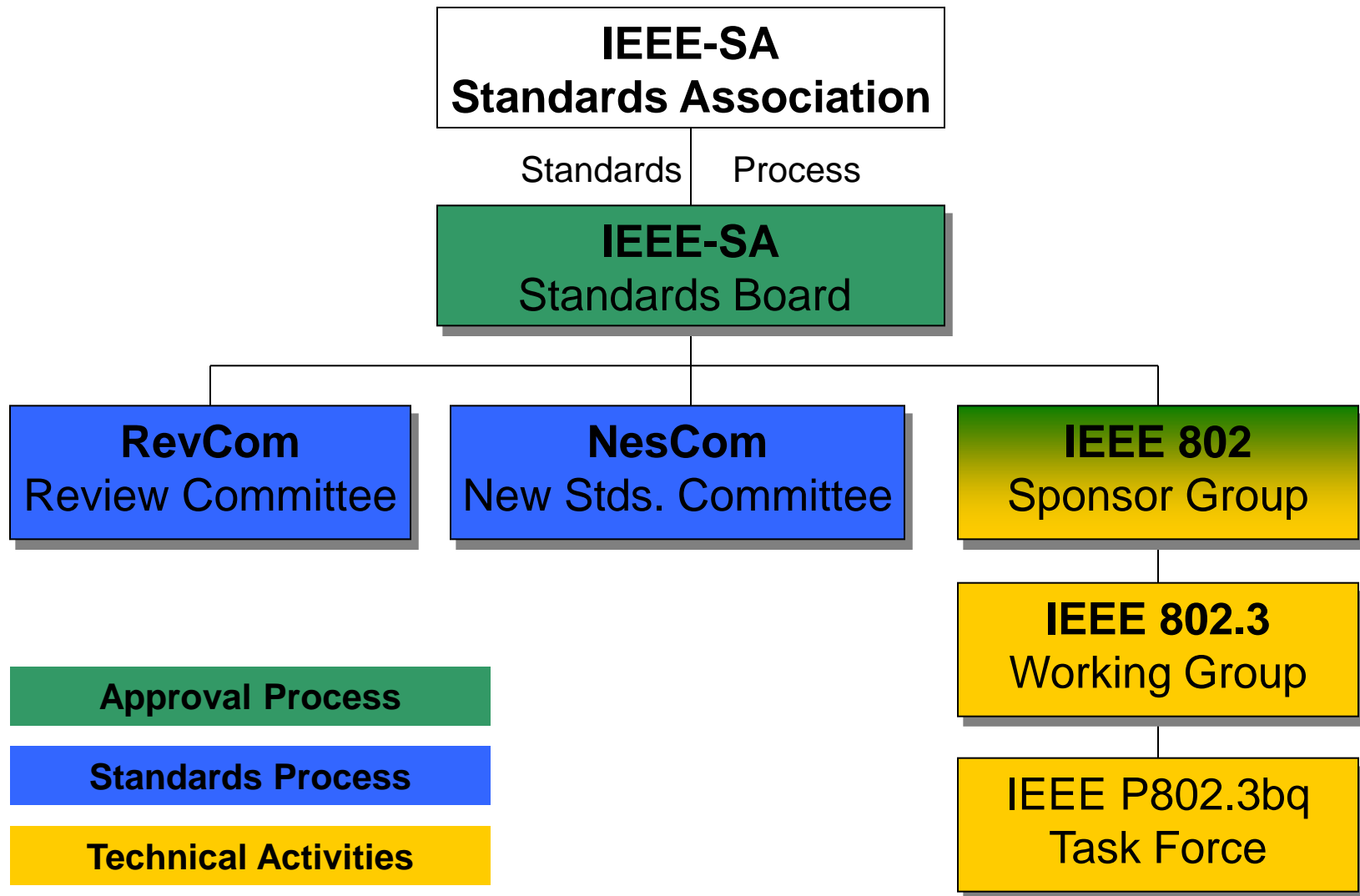

Important Bylaws and Rules

- **IEEE-SA Operations Manual**
http://standards.ieee.org/develop/policies/sa_opman/
- **IEEE-SA Standards Board Bylaws**
<http://standards.ieee.org/develop/policies/bylaws/>
- **IEEE-SA Standards Board Operations Manual**
<http://standards.ieee.org/develop/policies/opman/>
- **IEEE 802 LAN/MAN Standards Committee (LMSC) Policies and Procedures**
<http://standards.ieee.org/about/sasb/audcom/pnp/LMSC.pdf>
- **IEEE 802 LAN/MAN Standards Committee (LMSC) Operations Manual**
<http://www.ieee802.org/devdocs.shtml>
- **IEEE 802 LAN/MAN Standards Committee (LMSC) Working Group (WG) Policies and Procedures**
<http://www.ieee802.org/devdocs.shtml>
- **IEEE 802.3 Working Group Operating Rules**
http://ieee802.org/3/rules/P802_3_rules.pdf

Instructions for the WG Chair

The IEEE-SA strongly recommends that at each WG meeting the chair or a designee:

- **Show slides #1 through #4 of this presentation**
- **Advise the WG attendees that:**
 - The IEEE's patent policy is described in Clause 6 of the *IEEE-SA Standards Board Bylaws*;
 - Early identification of patent claims which may be essential for the use of standards under development is strongly encouraged;
 - There may be Essential Patent Claims of which the IEEE is not aware. Additionally, neither the IEEE, the WG, nor the WG chair can ensure the accuracy or completeness of any assurance or whether any such assurance is, in fact, of a Patent Claim that is essential for the use of the standard under development.
- **Instruct the WG Secretary to record in the minutes of the relevant WG meeting:**
 - That the foregoing information was provided and that slides 1 through 4 (and this slide 0, if applicable) were shown;
 - That the chair or designee provided an opportunity for participants to identify patent claim(s)/patent application claim(s) and/or the holder of patent claim(s)/patent application claim(s) of which the participant is personally aware and that may be essential for the use of that standard
 - Any responses that were given, specifically the patent claim(s)/patent application claim(s) and/or the holder of the patent claim(s)/patent application claim(s) that were identified (if any) and by whom.
- The WG Chair shall ensure that a request is made to any identified holders of potential essential patent claim(s) to complete and submit a Letter of Assurance.
- It is recommended that the WG chair review the guidance in *IEEE-SA Standards Board Operations Manual* 6.3.5 and in FAQs 14 and 15 on inclusion of potential Essential Patent Claims by incorporation or by reference.

Note: **WG** includes Working Groups, Task Groups, and other standards-developing committees with a PAR approved by the IEEE-SA Standards Board.



Participants, Patents, and Duty to Inform

All participants in this meeting have certain obligations under the IEEE-SA Patent Policy.

- **Participants [Note: Quoted text excerpted from IEEE-SA Standards Board Bylaws subclause 6.2]:**
 - **“Shall inform the IEEE (or cause the IEEE to be informed)” of the identity of each “holder of any potential Essential Patent Claims of which they are personally aware” if the claims are owned or controlled by the participant or the entity the participant is from, employed by, or otherwise represents**
 - **“Should inform the IEEE (or cause the IEEE to be informed)” of the identity of “any other holders of potential Essential Patent Claims” (that is, third parties that are not affiliated with the participant, with the participant’s employer, or with anyone else that the participant is from or otherwise represents)**
- **The above does not apply if the patent claim is already the subject of an Accepted Letter of Assurance that applies to the proposed standard(s) under consideration by this group**
- **Early identification of holders of potential Essential Patent Claims is strongly encouraged**
- **No duty to perform a patent search**

Patent Related Links

All participants should be familiar with their obligations under the IEEE-SA Policies & Procedures for standards development.

Patent Policy is stated in these sources:

IEEE-SA Standards Boards Bylaws

<http://standards.ieee.org/develop/policies/bylaws/sect6-7.html#6>

IEEE-SA Standards Board Operations Manual

<http://standards.ieee.org/develop/policies/opman/sect6.html#6.3>

Material about the patent policy is available at

<http://standards.ieee.org/about/sasb/patcom/materials.html>

If you have questions, contact the IEEE-SA Standards Board Patent Committee Administrator at patcom@ieee.org or visit <http://standards.ieee.org/about/sasb/patcom/index.html>

This slide set is available at
<https://development.standards.ieee.org/myproject/Public/mytools/mob/slideset.ppt>



Call for Potentially Essential Patents

- If anyone in this meeting is personally aware of the holder of any patent claims that are potentially essential to implementation of the proposed standard(s) under consideration by this group and that are not already the subject of an Accepted Letter of Assurance:
 - Either speak up now or
 - Provide the chair of this group with the identity of the holder(s) of any and all such claims as soon as possible or
 - Cause an LOA to be submitted

Other Guidelines for IEEE WG Meetings

- **All IEEE-SA standards meetings shall be conducted in compliance with all applicable laws, including antitrust and competition laws.**
 - **Don't discuss the interpretation, validity, or essentiality of patents/patent claims.**
 - **Don't discuss specific license rates, terms, or conditions.**
 - Relative costs, including licensing costs of essential patent claims, of different technical approaches may be discussed in standards development meetings.
 - Technical considerations remain primary focus
 - **Don't discuss or engage in the fixing of product prices, allocation of customers, or division of sales markets.**
 - **Don't discuss the status or substance of ongoing or threatened litigation.**
 - **Don't be silent if inappropriate topics are discussed ... do formally object.**

See *IEEE-SA Standards Board Operations Manual*, clause 5.3.10 and “Promoting Competition and Innovation: What You Need to Know about the IEEE Standards Association’s Antitrust and Competition Policy” for more details.

Overview of IEEE 802.3 Standards Process (1/5)- Study Group Phase

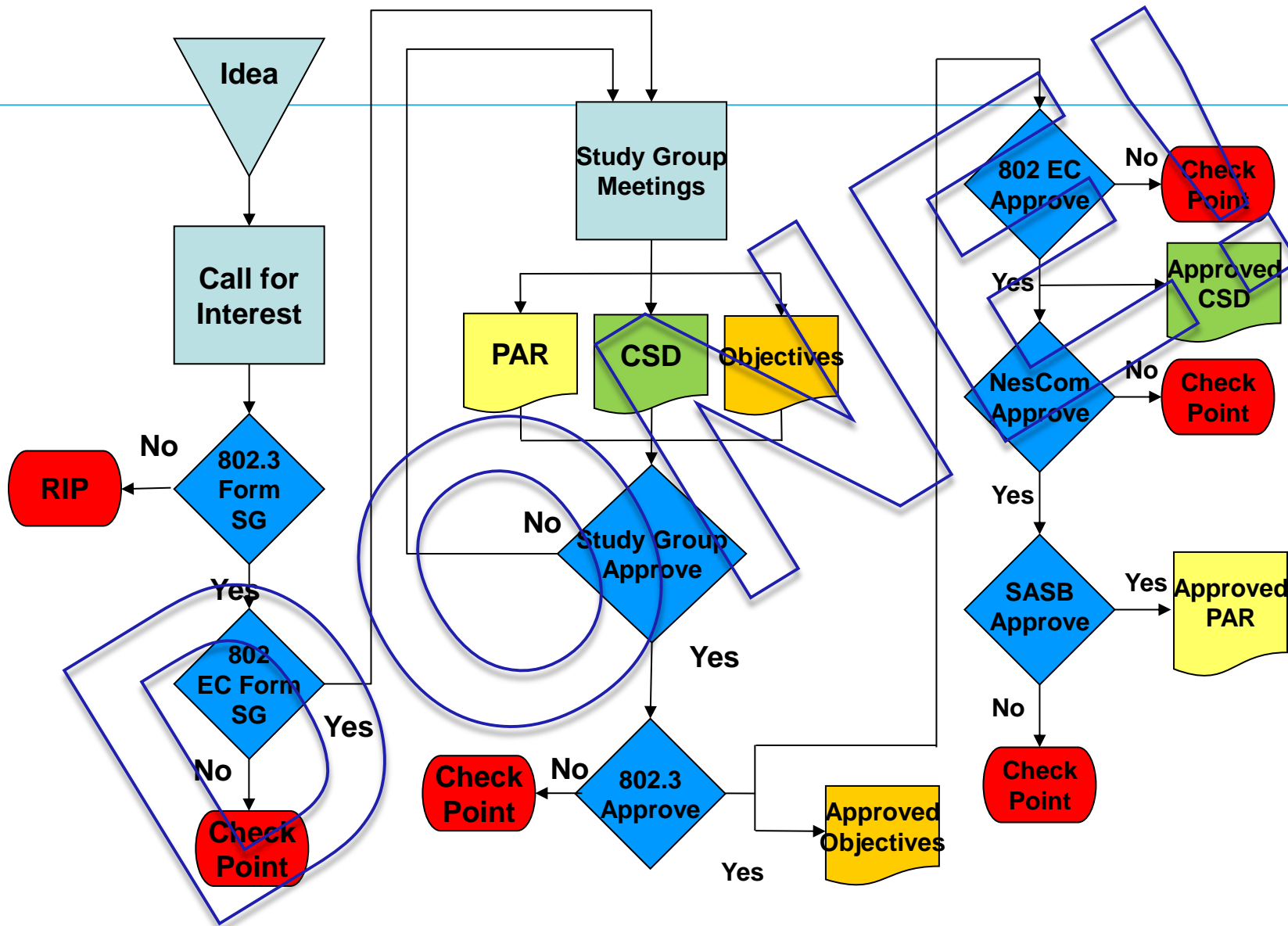

Note: At "Check Point", either the activity is ended, or there may be various options that would allow reconsideration of the approval.

Overview of IEEE 802.3 Standards Process (2/5) – Task Force Comment Phase

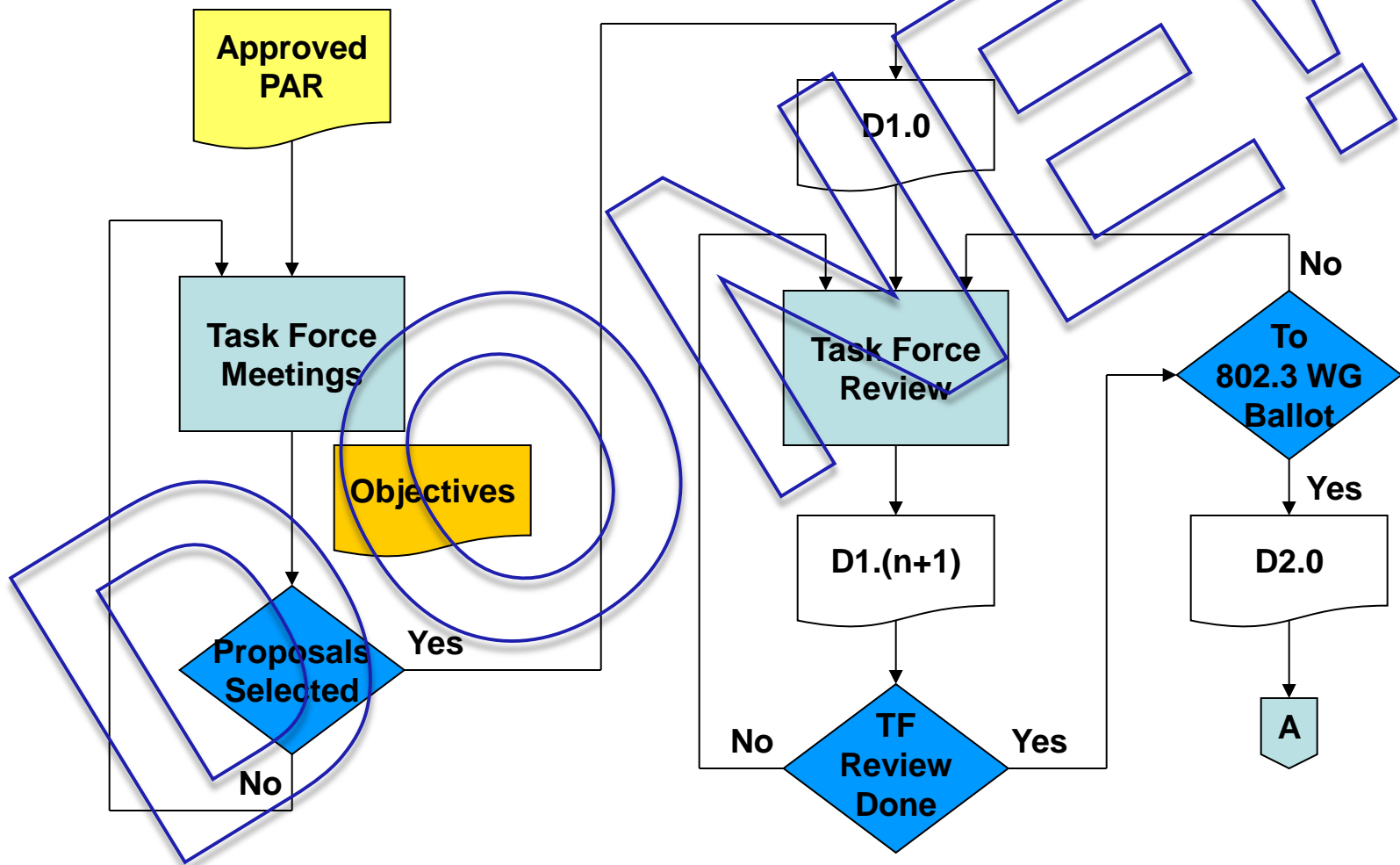

Overview of IEEE 802.3 Standards Process (3/5) – Working Group Ballot Phase

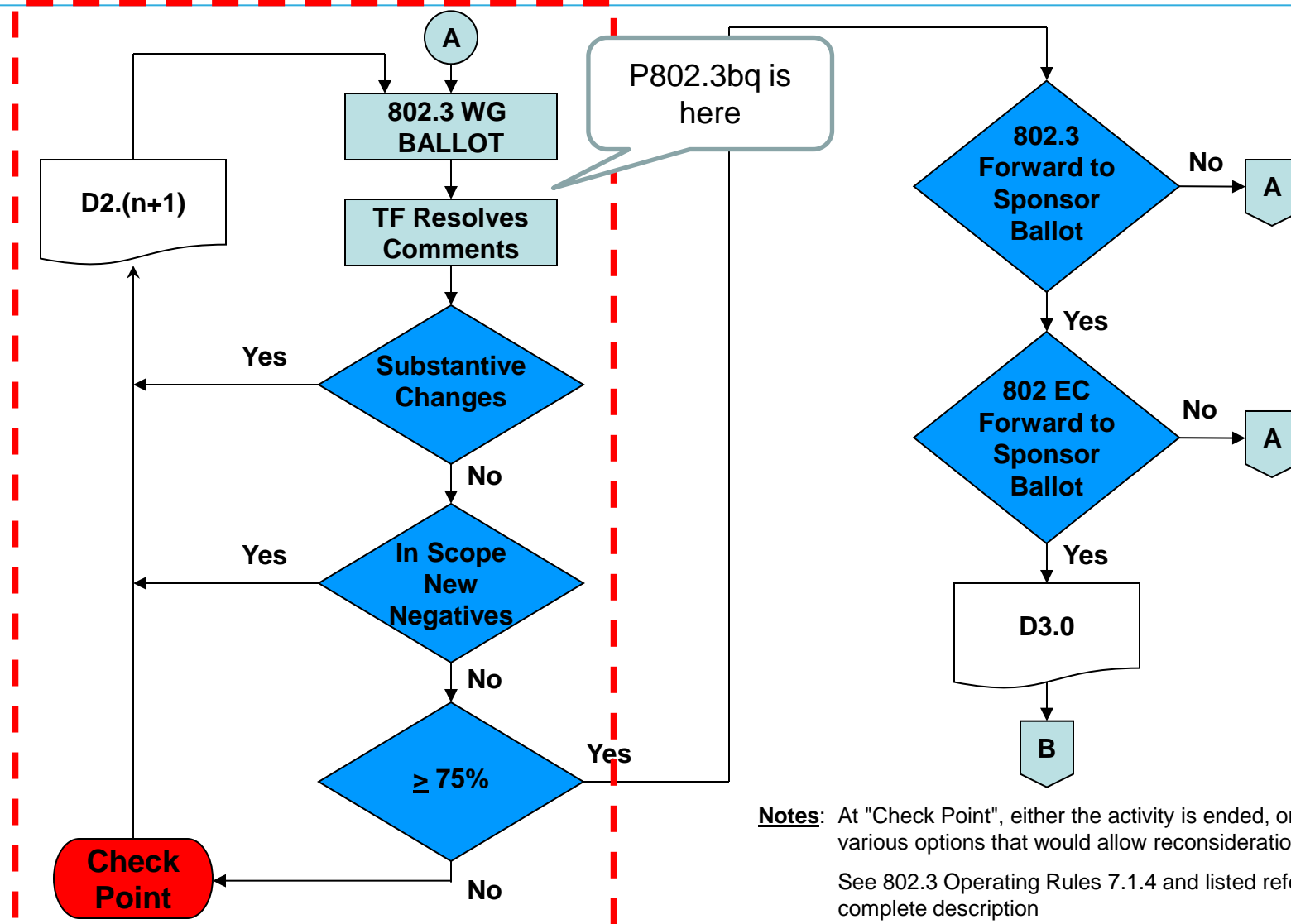

Overview of IEEE 802.3 Standards Process (4/5)- Sponsor Ballot Phase

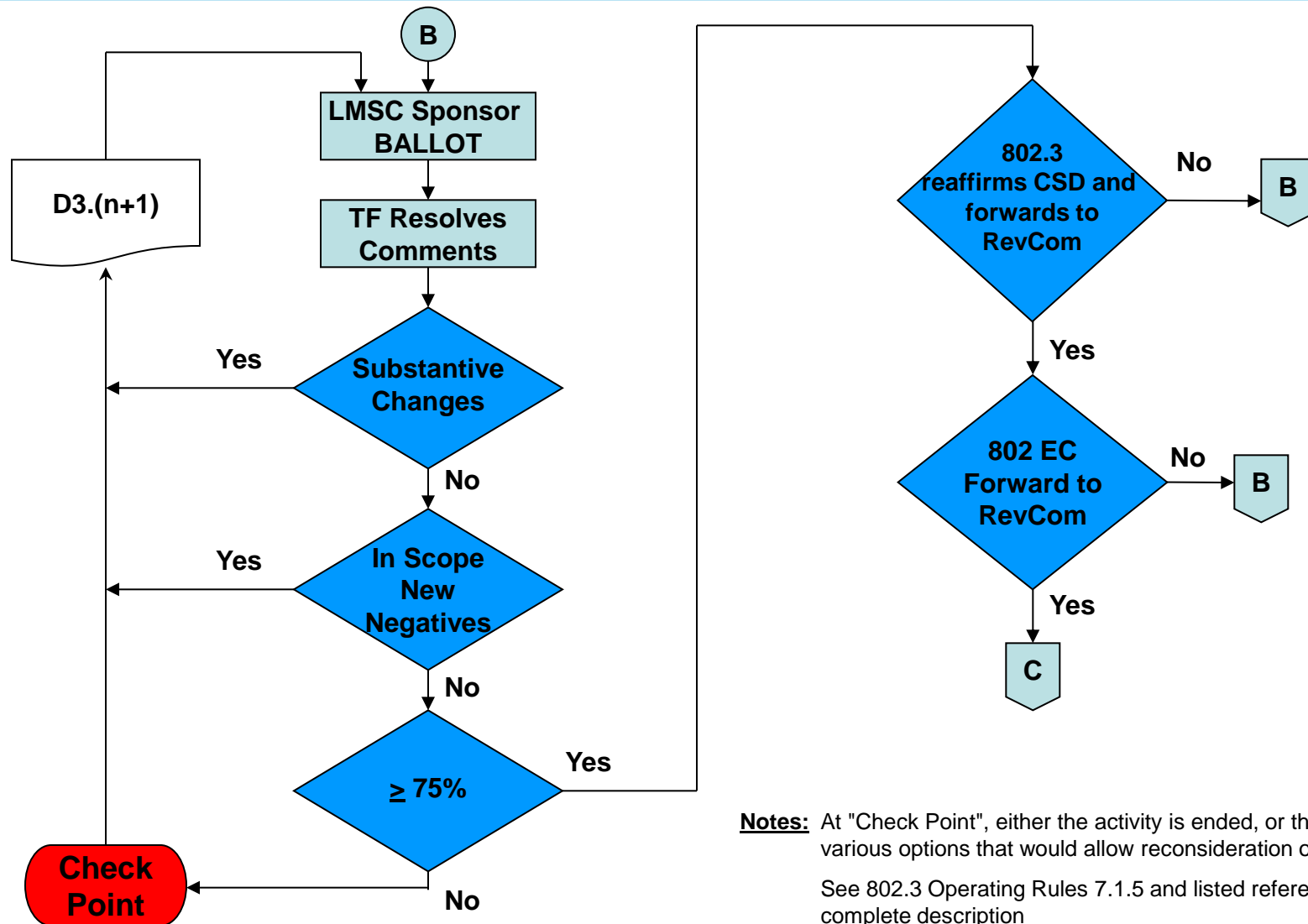

Notes: At "Check Point", either the activity is ended, or there may be various options that would allow reconsideration of the approval. See 802.3 Operating Rules 7.1.5 and listed references for complete description

Overview of IEEE 802.3 Standards Process (5/5) – Final Approvals / Standard Release

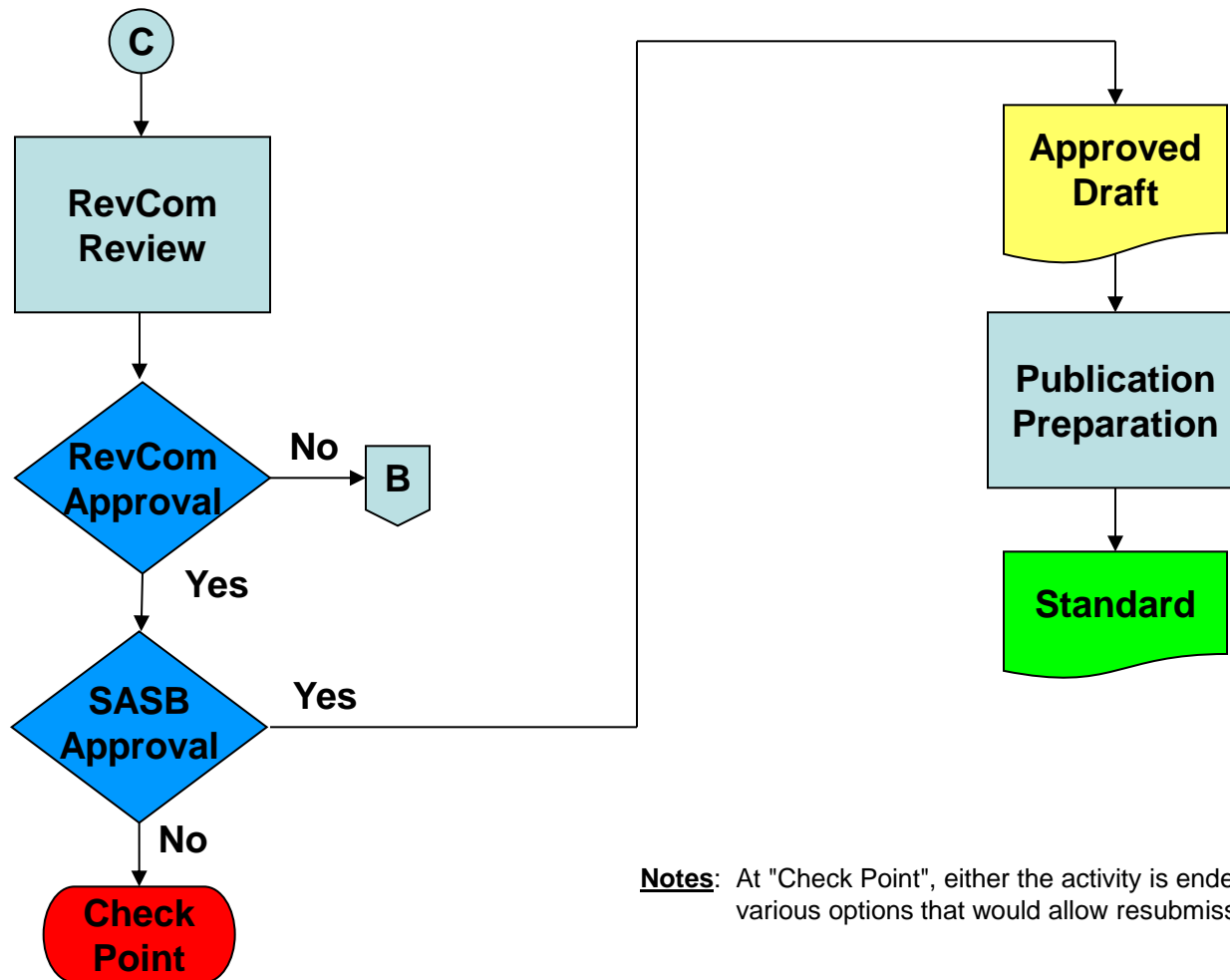

Notes: At "Check Point", either the activity is ended, or there may be various options that would allow resubmission for approval.

Liaisons and Communications

ISO/IEC JTC1 SC25 to IEEE 802.3 on 25GBASE-T

ISO/IEC JTC1 SC25 to IEEE 802.3 on 40GBASE-T
return loss requirements

Note to Presenters

- filename conventions:
 - *presenterlastname_3bq_XYr_mmyy.pdf*
 - *presenterlastname_3bz_XYr_mmyy.pdf*
 - XY is presentation number, i.e. 01, 02 ,03
 - For this meeting
 - Revisions (r) are a,b,c, etc.
 - No spaces in filename
 - Example: carlson_3bq_01a_0713.pdf

IEEE P802.3bq 40GBASE-T Working Group ballot results

Draft 2.2 Working Group Ballot 2nd recirculation

- opened, 16 August 2015, closed 30 August 2015
- Vote tally:

Comments: 96

	Recirculation Draft D2.2			Req %
	#	%	Status	
Abstain	32	19.5	PASS	< 30
Disapprove with comment	15	11.4	-	-
Disapprove without comment		-	-	-
Approve	117	88.6	PASS	≥ 75
Ballots returned	164	59.9	PASS	> 50
Voters	274	-	-	-

Agenda notes

- 9:00am to ~6pm Monday, 9am to noon Tuesday
 - Ad hoc report
 - Chief Editor's report
 - Overview of 25GBASE-T changes needed
 - Review topics in common with P802.3bz
 - Agenda is largely driven by comment resolution
 - See Editor's Report
 - Additional presentations heard as needed for comment resolution
- For Consideration:
 - Some topics are related to P802.3bz, thus P802.3bq could defer resolution on such comments and closing until Wednesday after consideration by P802.3bz



Future Meetings

- See: <http://www.ieee802.org/3/interims/index.html>
- See: <http://802world.org/plenary/future-plenary-sessions>
- Nov 2015 Plenary Week of Nov 8
 - Hyatt Regency Dallas, Dallas, TX, USA
- Jan 2016 Interim Week of Jan 18
 - Atlanta, GA
- March 2016 Plenary Week of March 13
 - The Venetian Macao, Macao SAR, P.R. China
- Anyone interested in hosting a interim meeting contact the IEEE 802.3 Executive Secretary [Steve Carlson](#).

Thank You!