

25G- to 50G- to 100G-EPON Upgrade Scenarios

Glen Kramer, glen.kramer@broadcom.com

Device/system representation

Abstract device/system representation used in this document

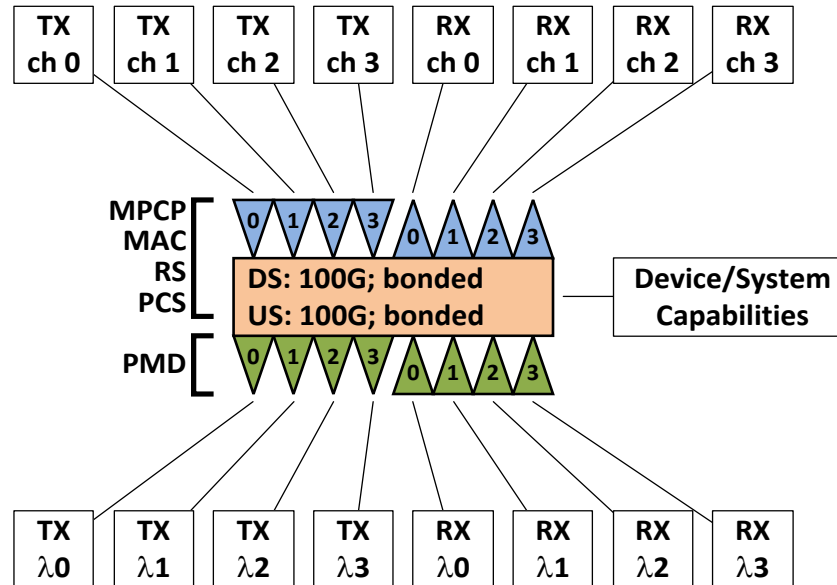

- Enabled IC blocks



- Enabled Optical Module blocks



- Blocks not implemented by component vendors



- Blocks disabled by system vendor

ONU Upgradability Options

- ❑ An ONU needs to be upgraded if its user switches to higher service plan
- ❑ Depending on relative costs of ONU IC and optics of each generation, different upgrade scenarios may be more practical

1) Replace ONU

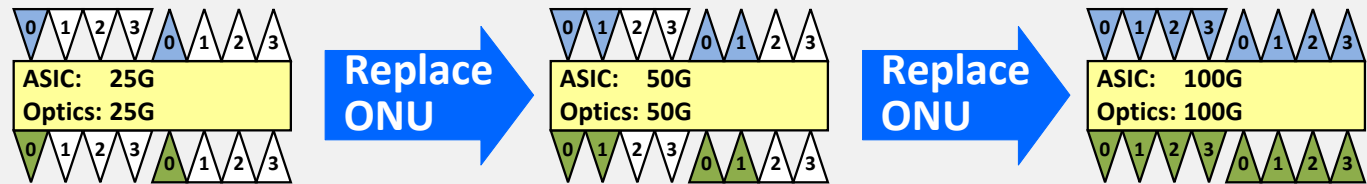

2) Replace Optical Module

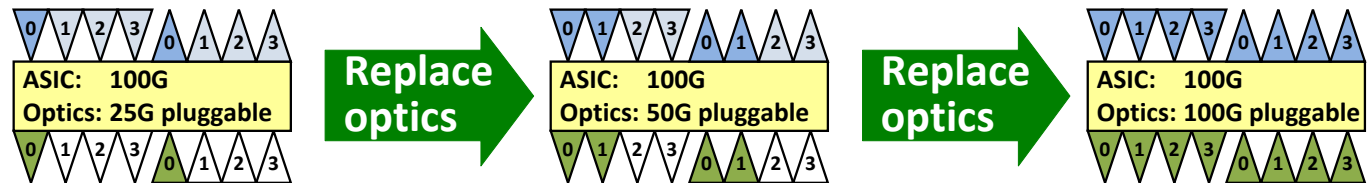

3) Replace Gen1 ONU, replace Gen2 Optical Module

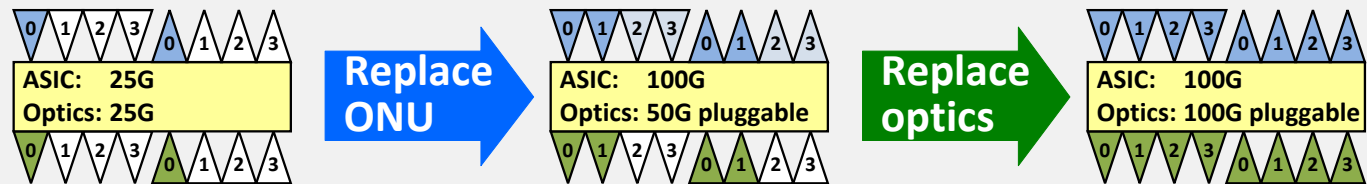

4) Replace Gen1 Optical Module, replace Gen2 ONU

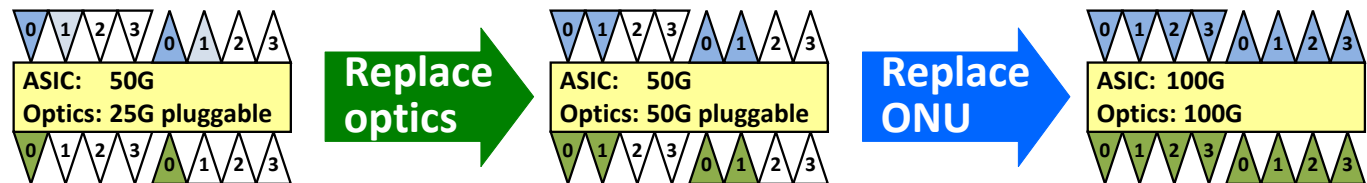

Only symmetrical implementations are shown.

OLT Upgradability Options

- Depending on the relative costs of OLT IC and optics of each generation, different upgrade scenarios may be more practical

1) Replace Line Card

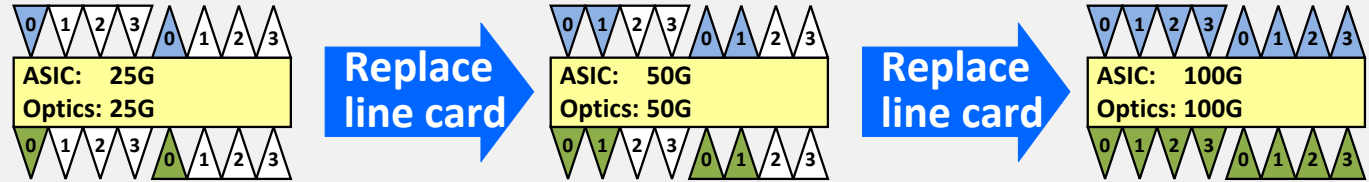

2) Replace Optical Module

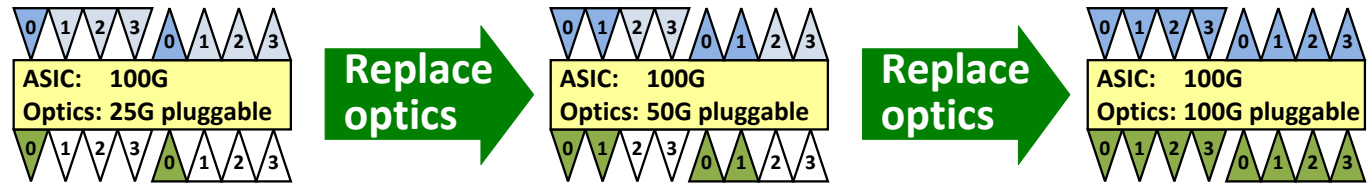

3) Replace Gen1 Line Card, replace Gen2 Optical Module

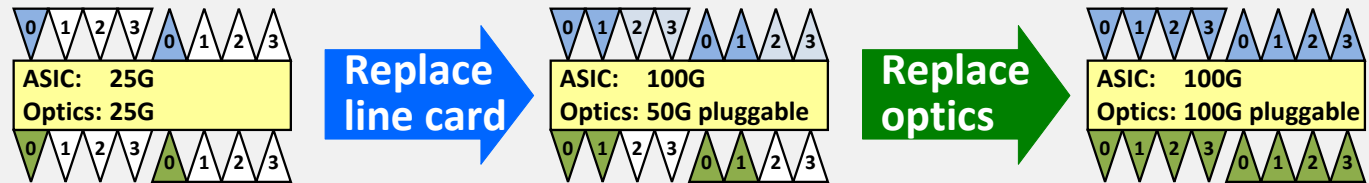

4) Replace Gen1 Optical Module, replace Gen2 Line Card

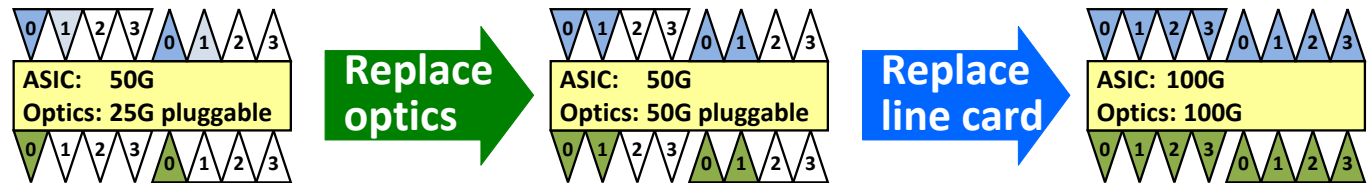

Only symmetrical implementations are shown.

“Two Line Cards” Method

- ❑ In 1+4 wavelength scenario, 25 Gb/s line cards remain in operation.
- ❑ To upgrade the OLT to 50 Gb/s, a new line card and an external WDM splitter/combiner are added.
- ❑ To upgrade the OLT to 100 Gb/s, the 50G line card or the optical module still need to be replaced

1) Add Line Card + Replace Line Card

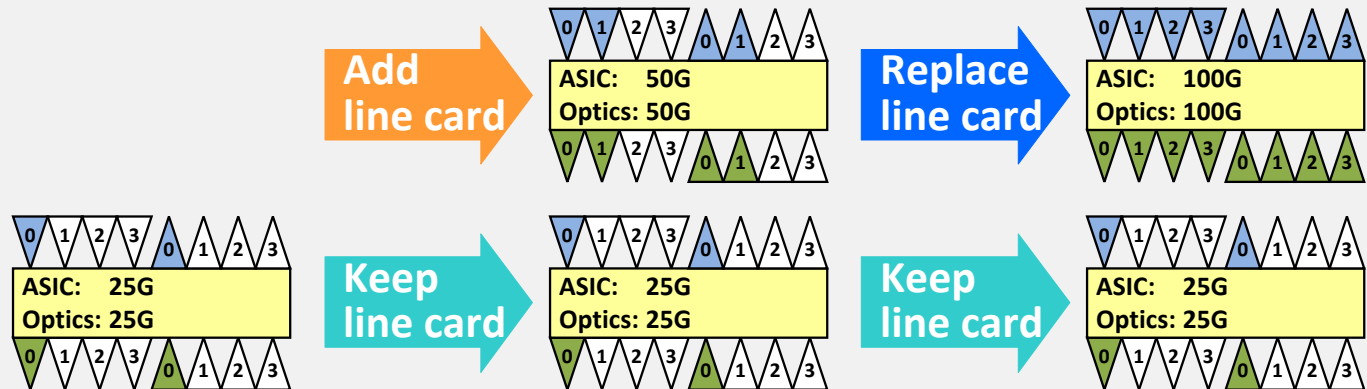

2) Add Line Card + Replace Optical Module

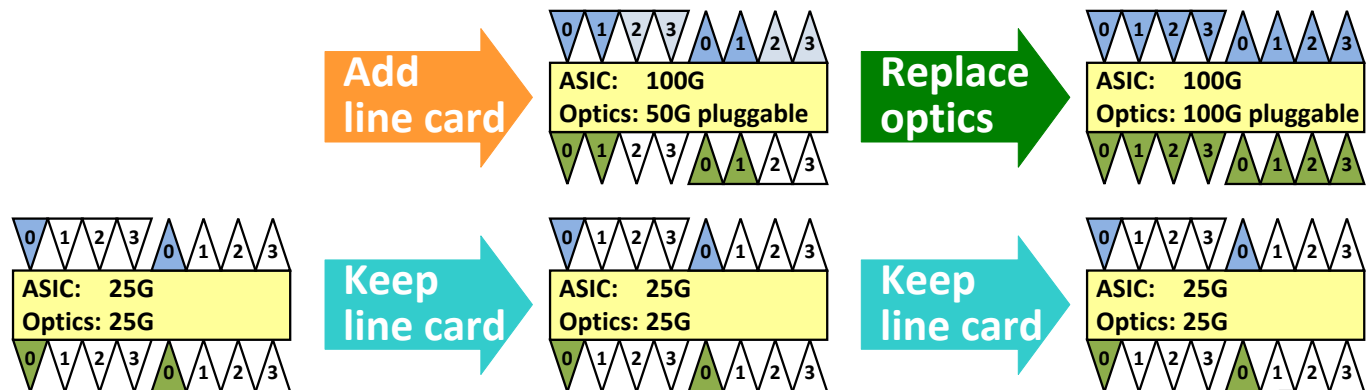

Keeping vs. Replacing 25G line cards

- ❑ The notion that adding a new 50 Gb/s line card to an existing 25 Gb/s line card is cheaper than replacing 25 Gb/s line card is a misconception.
- ❑ Total CapEx is higher, CapEx per Gb/s is about the same:
 - Instead of reusing the replaced 25 Gb/s cards in new deployments, more 25 Gb/s line cards will have to be procured
 - Assume 50G line card cost = 2x 25G line card cost
 - **“Two Line Cards”** solution:
 - » Upgraded EPON OLT cost: $1x + 2x = 3x$ for 75 Gb/s (old line card + new line card)
 - » New EPON OLT cost: 1x for 25Gb/s (new line card)
 - » Total: **4x for 100 Gb/s capacity**
 - **“One Line Card”** solution:
 - » Upgraded EPON OLT cost: $1x + 2x$ for 50 Gb/s (replaced old line card + new line card)
 - » New EPON OLT cost: $\sim 0x$ for 25 Gb/s (reuse existing old line card)
 - » Total: **3x for 75 Gb/s capacity**
- ❑ OpEx of **“Two Line Cards”** solution is higher:
 - Provides 1.5x capacity at twice the operational cost
 - Double the line card slots consumed
 - Double the total OLT power
 - Extra racks for a more complex fiber management

- ❑ The “Two Line Cards” upgrade scenario requires the “1 + 4” wavelength plan.
- ❑ “One Line Card” method has better economics than the “Two Line Cards” method
 - Operators can decide what is more cost-efficient –
 - Start deployments with faster IC (50G or 100G instead of 25G) and upgrade optics later, or
 - Use slower IC and slower optics initially, and later upgrade the entire device (ONU or Line Card)
- ❑ PHY challenges may necessitate the 1+4 wavelength plan, but we should not use the “Two Line Cards” upgrade method as a justification for it.

Thank You