



Multiple PMDs per PON Rate?

- High-speed PON consolidation



Eugene (Yuxin) Dai, Robert Kuse, Matthew Hayes
Cox Communications
802.3ca 100G EPON TF, IEEE Plenary Meeting
May, 2018

Background - one rate two PMDs (PHYs)?

- The issue was brought in Sep. 2017 meeting: **There are 2 types of 25G ONUs (PMDs)**
- It will divide the market and increase operational cost by creating two 25G islands (dai_3ca_02a_0917)

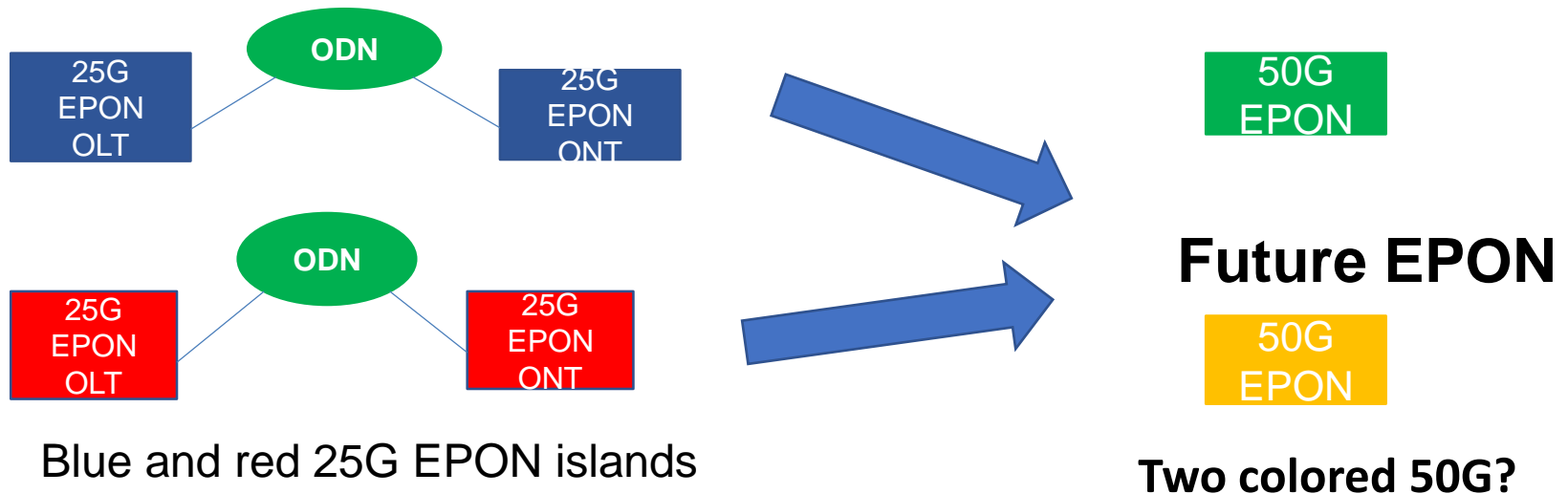

(dai_3ca_02a_0917)

- **The concern was whether the multiple PMDs at 25G will propagate to the next rate, ie. 50G and/or 100G**
- **It turn out that in current draft there are TWO types 2x25G (50G) PMDs**

Consolidate or Divide the Market?

- IEEE market rule is “One problem, one solution”
- If one argue that the two types of 25G are resulted from coexistence requirement with 10GE PON and GPON (two problems), then it should converge at the next PON rate
- In current draft, there are two types of 50G. What are the two problems?

- Are we creating these problems?
- There is no justification that there are two distinct 50G markets
- It will continue dividing the high-speed PON market
- It will continue to create operational problem by maintaining two OSPs – increase OPEX

Current wavelength plan results two 25G PMDs and two 2x25G PMDs

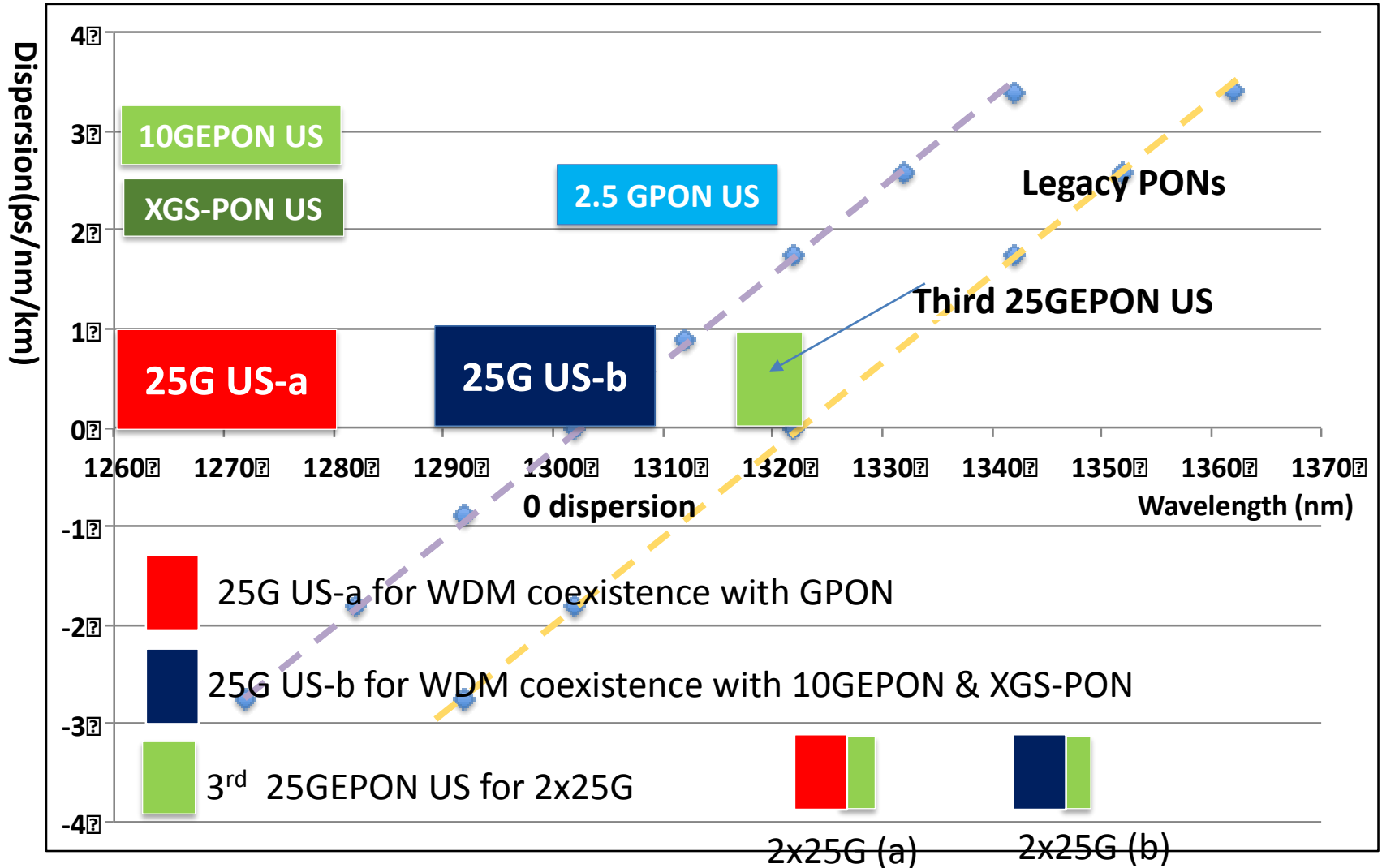

Migration of blue 25G to 2x25G (blue+green, from 10G PON coexistence)

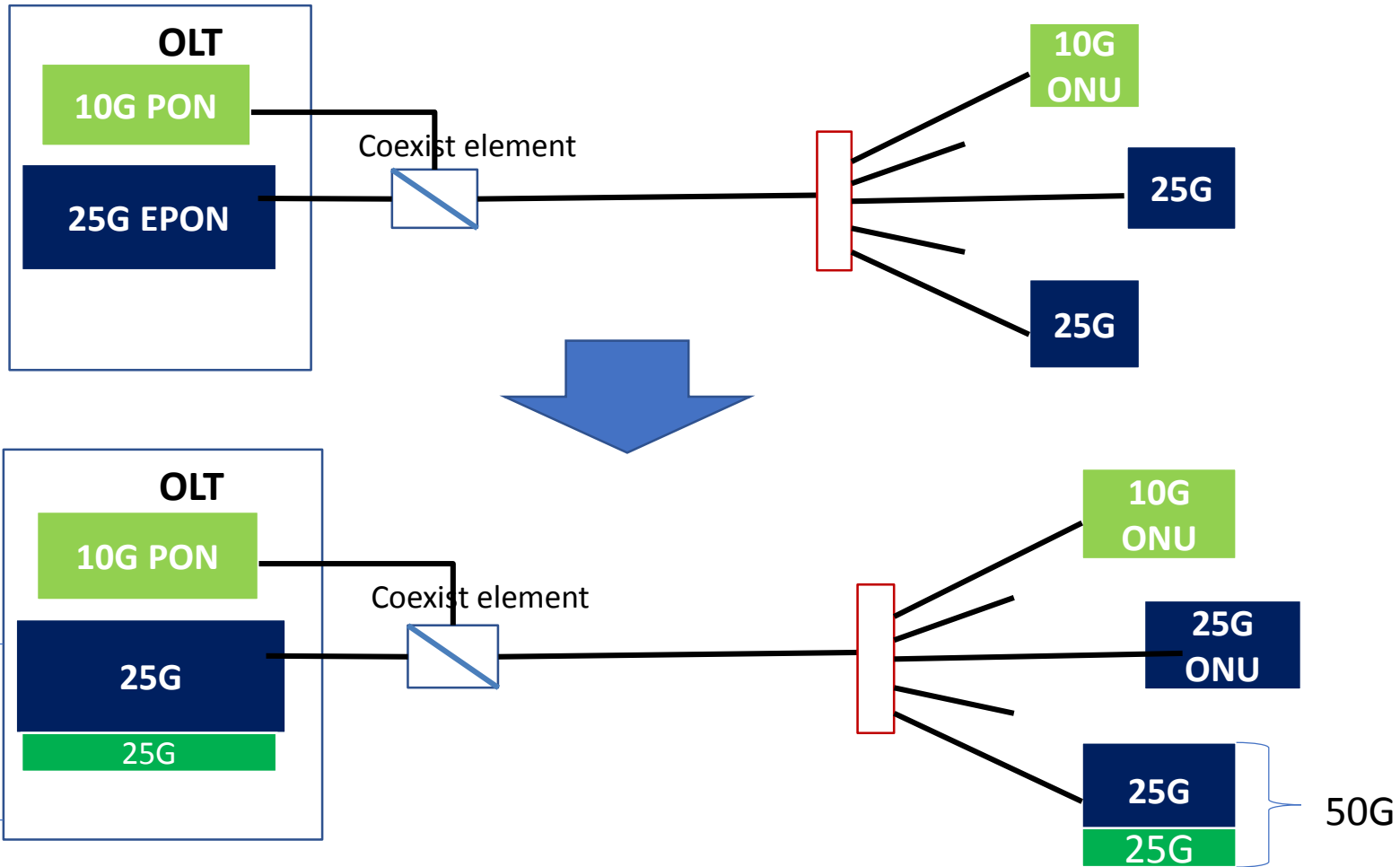

Type I 2x25 (Blue + Green) coexist with 10G EPON

Migration of red 25G to 2x25G (red+green, from GPON coexistence)

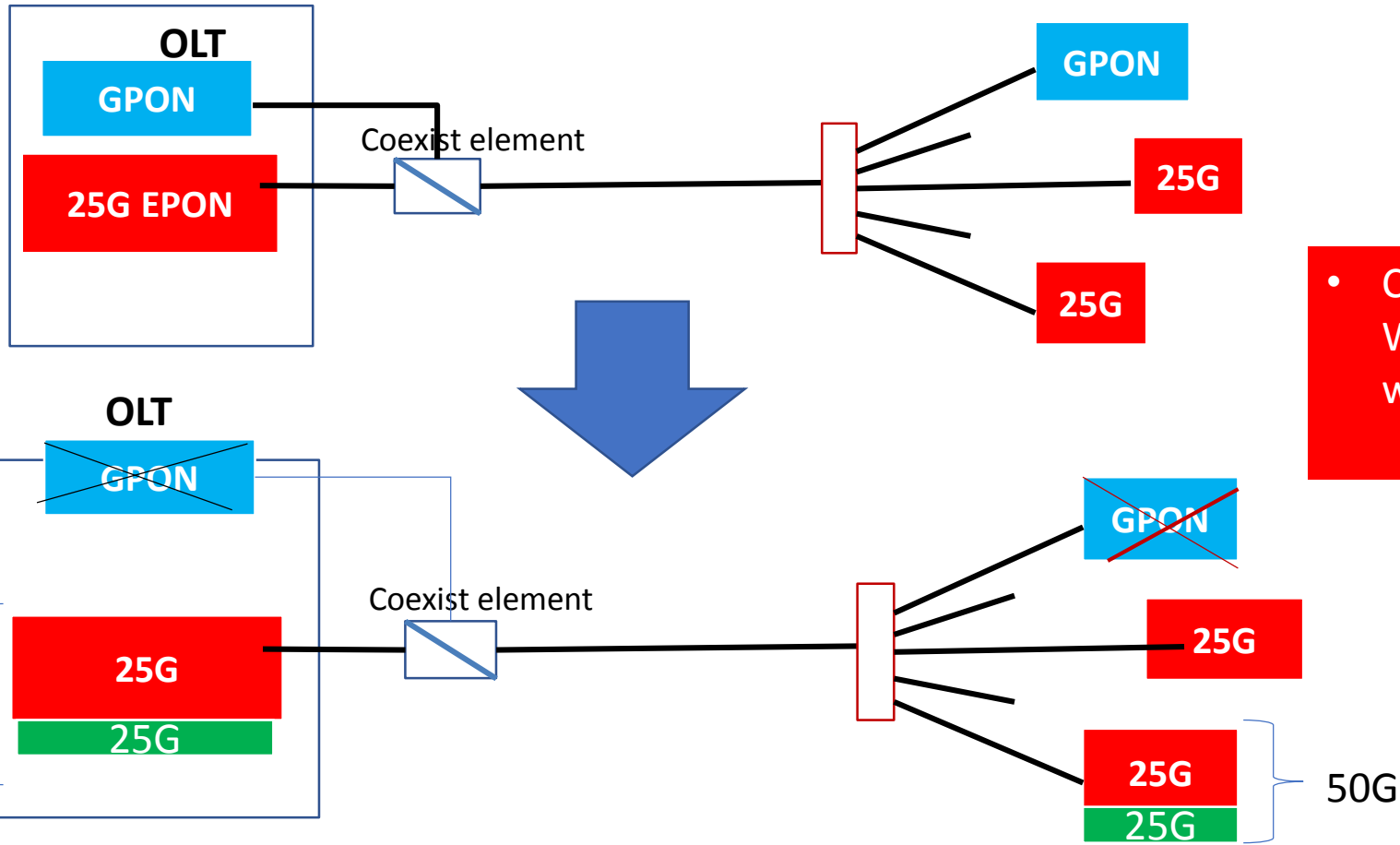

• Cannot WDM coexist with GPON

Type II 2x25G (red + green) is standard alone, does not WDM coexist with legacy PONs

End up with two types (colors) of 2x25G

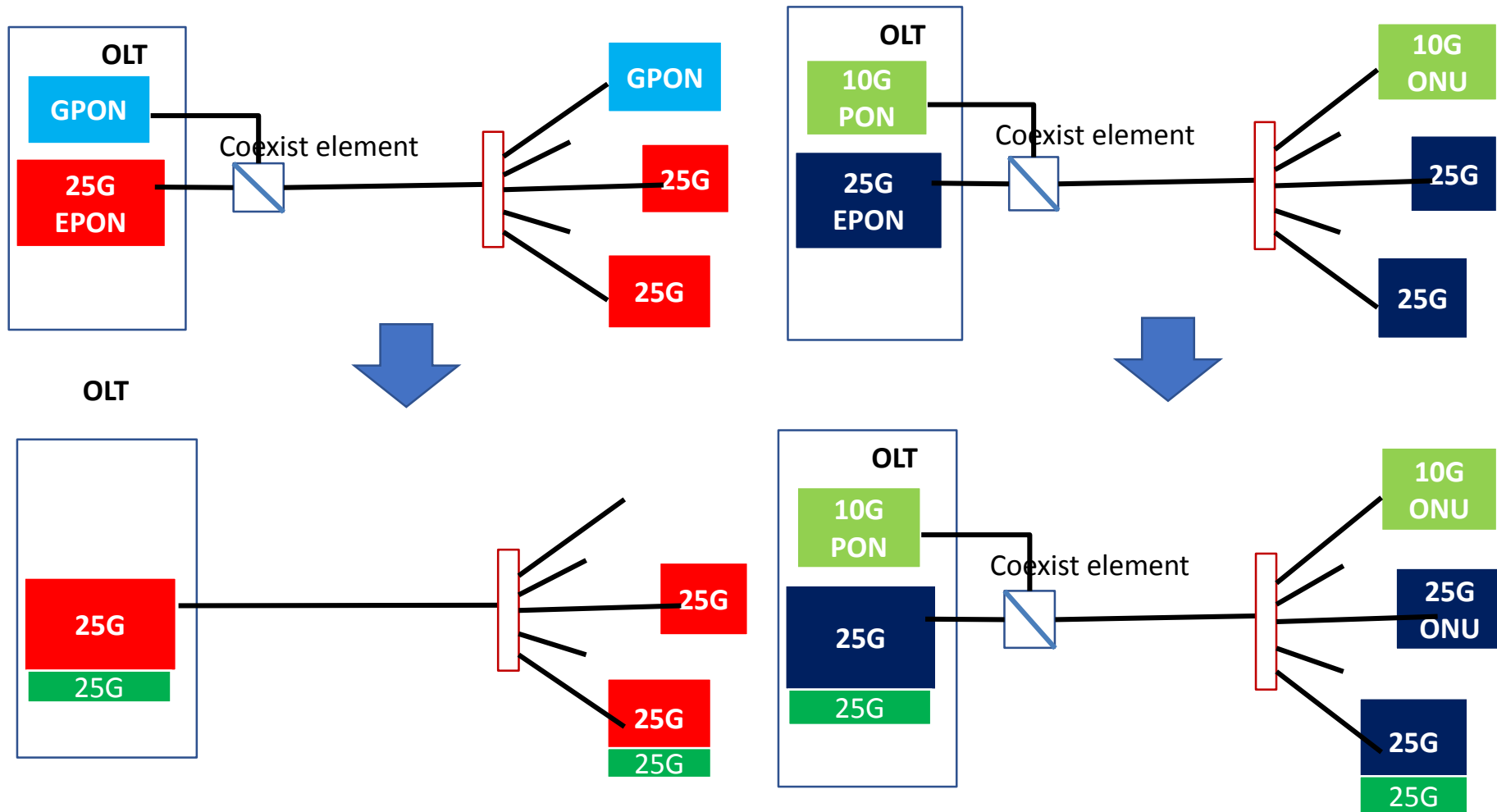

Two types (colors) of 50G ONUs (with 2x25G) in the field

At what rate can we unify NGEPON PMD?

- If we accept the divided PMDs at 25G rate as the result of backward compatibility (coexistence), then it should not propagate the next rate
- At 50G rate, whether it is 2x25G or single 50G, there should be only one PMD
- Unfortunately, in current draft there are TWO types 2x25G (50G) PMDs
- Will this continue to propagate into 100G rate?
- Are we create problems for the future?
- It there way to stop this unfortunate propagation?

The impacts of one rate two PMDs

- From products point of view, it divides the market**
- From operational point of view, it creates problems on OSP planning, inventory management and increase OPEX**
- From access network standard point of view, it creates optical spectrum allocation challenges for the future PON**

One rate two PMDs should be avoided at all cost. At least it shouldn't propagate to the next rate.

Solution I: Unify 50G PMD with single channel

Single channel 50G is one solution: There are still two types of 25G, but there is only one type of 50G

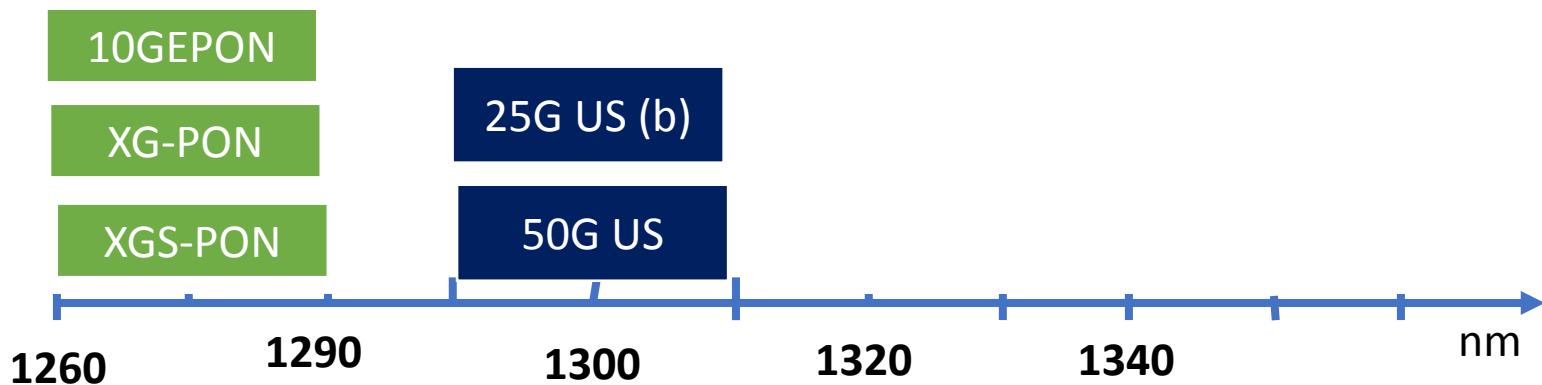
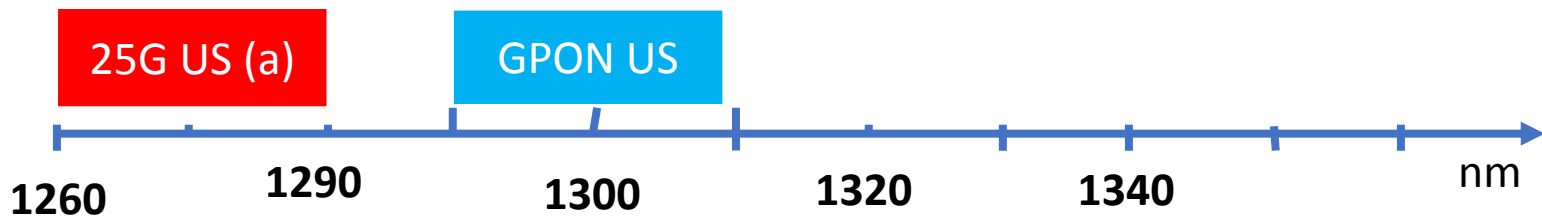

Solution I: Unify PMD at 50G and 100G rates

- Two 25G, red and blue. One 50G (blue)
- 50G WDM coexist with XGS-PON/XG-PON, 10GEPON
- GPON phase out at 50G stage
- 10G to 50G is the preferred upgrade path (5X increase)
- Blue 25G can TDM coexist with 50G (same frame structure, feasible with dual rate RX), or directly migrating to 100G
- Provide migration path to ONE 100G with 2x50G in the future

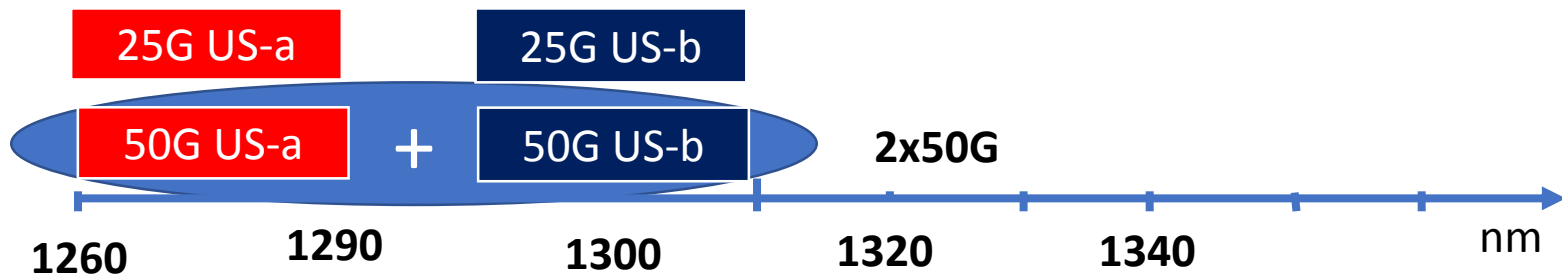

Solution II: Unify 50G PMD with 2x25G

Coexistence requirements: 10 Gbps PONs coexist 25G & 50GEPON(2x25G). GPON coexist with 25G

Two 25G

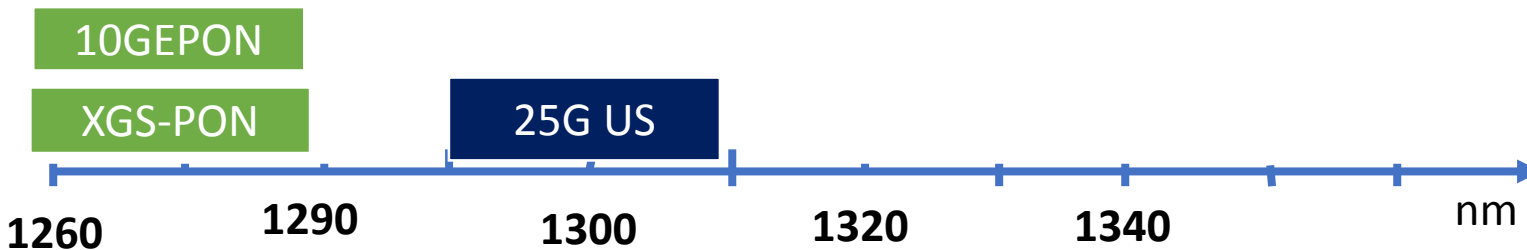
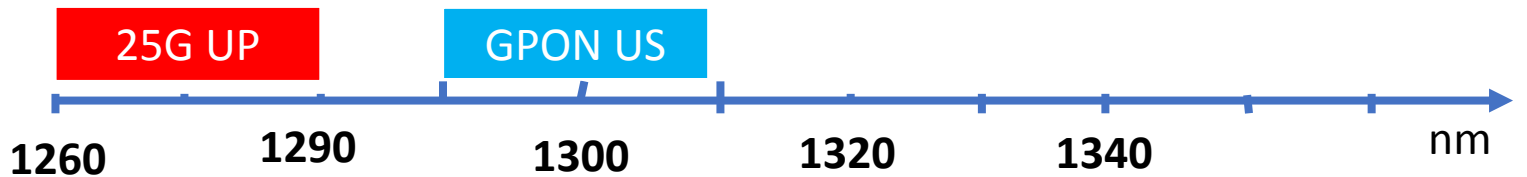

ONE 50G

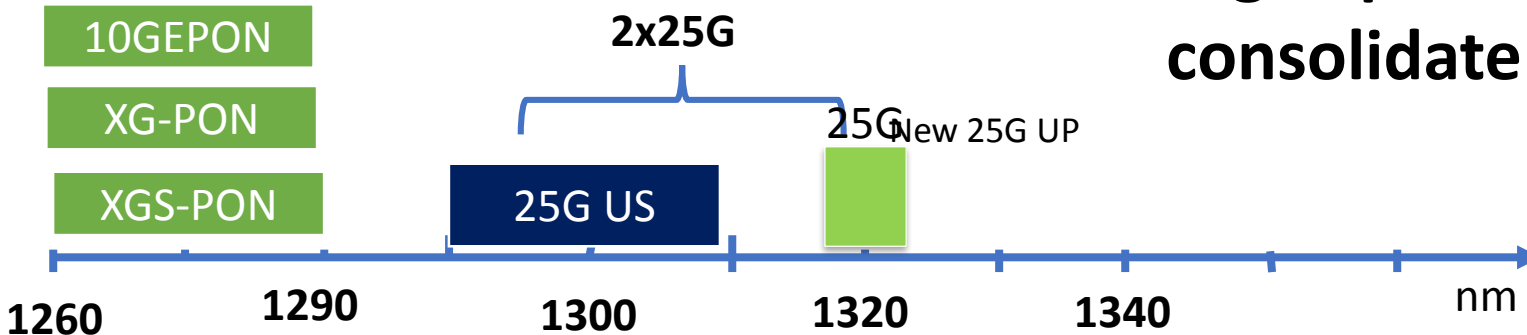

High-speed PONs consolidate at 50G

Solution II: Migration paths

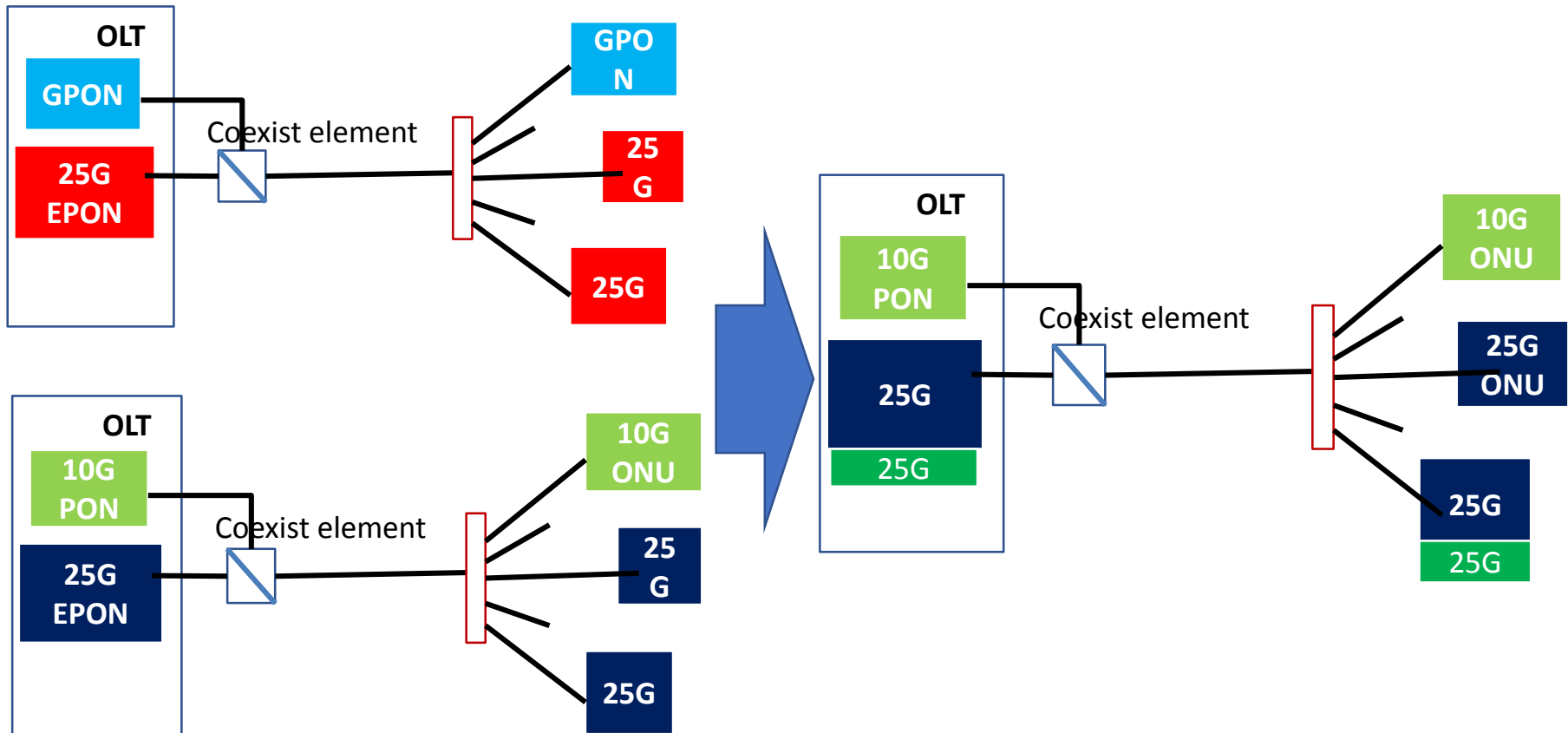

- GPON -> 25GEPON (red) with WDM coexist -> 2x25GEPOM (blue+green) with WDM coexist
- 10G PON -> 25GEPON (blue) with WDM coexist -> 2x25G (blue+green)

Solution III: Unify at 25G - reconsider coexistence requirements

Migration paths to 25G and 50G

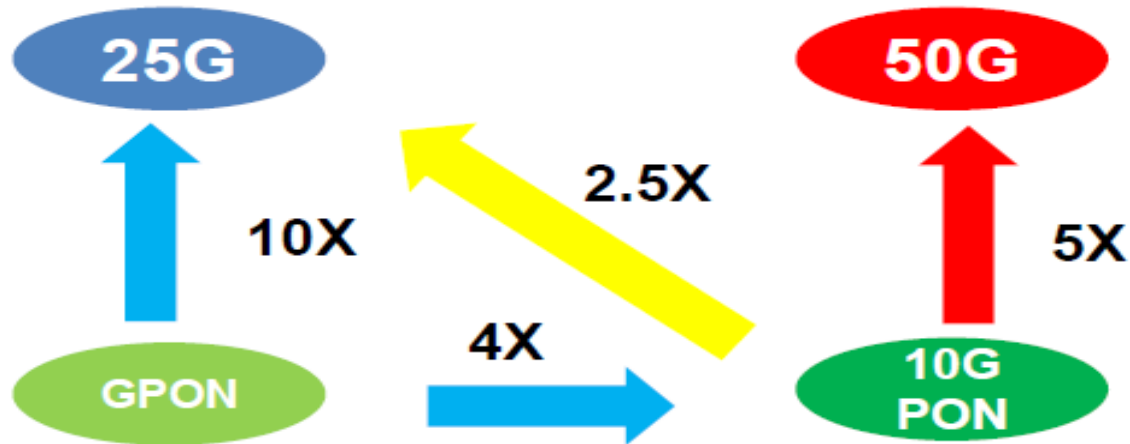

- 10G PON to 25G PON migration is a too small step
 - Reduce 10G PON splitting ratio to $\frac{1}{2}$ is roughly equivalent to migrate to 25G PON
- 10G PON should migrate to 50G PON (5X rate increase)

Dai_3ca_01a_1117

New coexistence requirements

Practical migration paths and coexistence

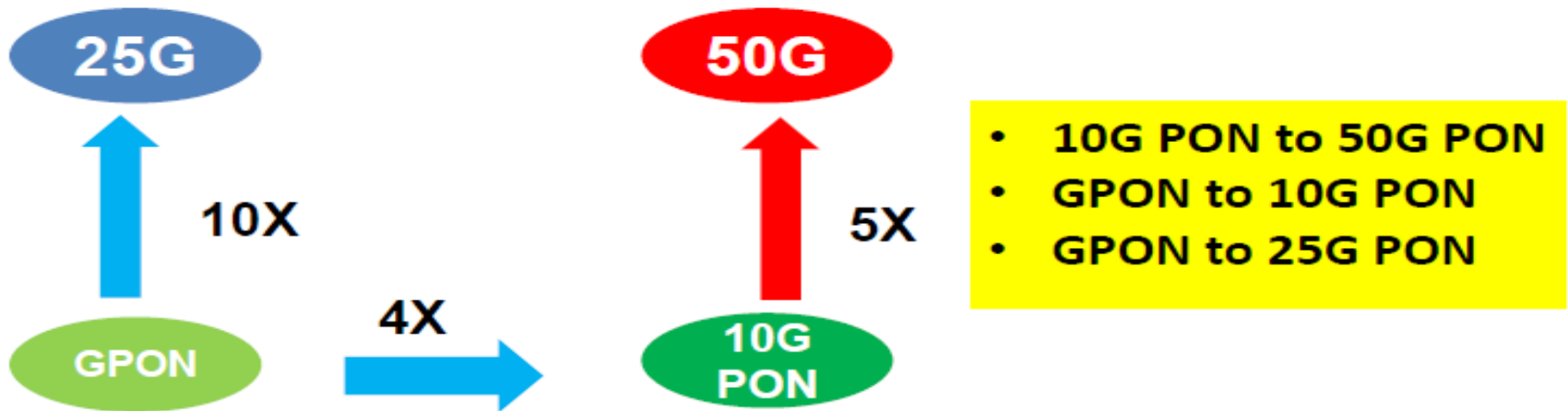

New coexistence requirements

- 25G PON only needs to coexist with GPON
- 50G PON only needs to coexist with 10G PON (10G EPON, XGS-PON)

Dai_3ca_01a_1117

Solution III: Unify PMD at 25G & 2x25G

New coexistence requirements: 10 Gbps PONs coexist
50GEPON(2x25G). GPON coexist with 25GEPON

ONE 25G

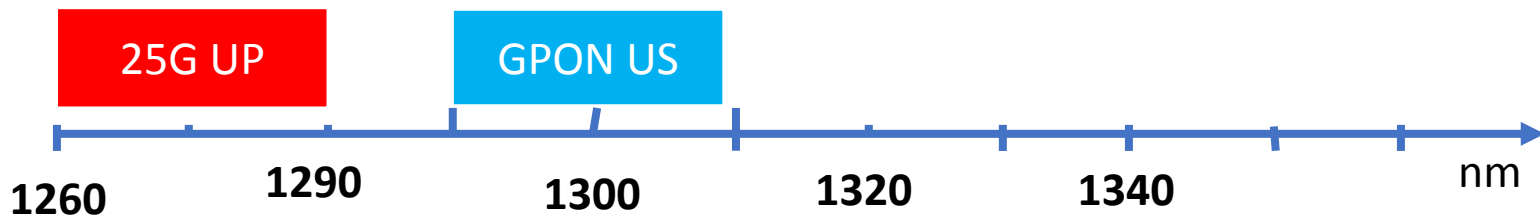

ONE 50G

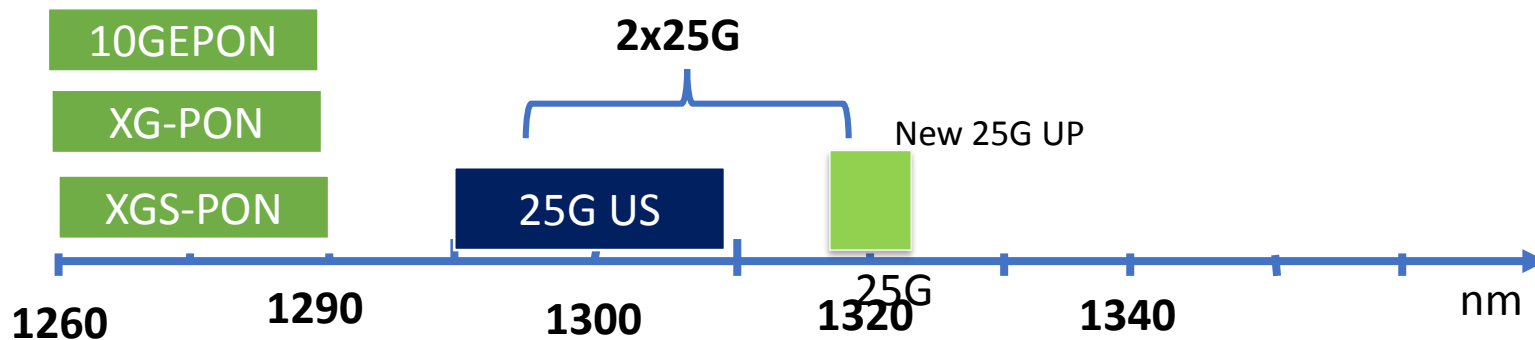

High-speed PONs consolidate at 25G and 50G

Conclusions

- **One rate multiple PMDs for PON should be avoided at all cost**
 - **Dividing market**
 - **Increasing OPEX**
- **Unify PMD – one rate one PMD, for high-speed PONs is possible at 25G, 50G and 100G.**

Motion

- **802.3ca 2x25G upstream channels only support wavelengths centered at 1300nm and 1320nm**



Thanks

Eugene.dai@cox.com