



Canova Tech

The Art of Silicon Sculpting

PIERGIORGIO BERUTO
GIAN MARCO BO

IEEE802.3cg TF

PSD mask and updated EMC simulations

January 17th, 2018

Channel Characteristics

- Channel defined as in

http://www.ieee802.org/3/cg/public/Sept2017/DiBiasoBergner_01c_0917.pdf slide #18

Return Loss (f) > 14 dB for f (0.3MHz -> 10MHz)
> 14 - 10*log10(f/10) dB for f (10MHz -> 40MHz)

Insertion Loss (f) < 1.0 + 1.6*(f-1)/9 dB for f (0.3MHz -> 10MHz)
< 2.6 + 2.3*(f-10)/23 dB for f (10MHz -> 33MHz)
< 4.9 + 2.3*(f-33)/33 dB for f (33MHz -> 40MHz)

Mode Conversion Loss (f) > 30 dB for f (0.3MHz -> 20MHz)
> 30-20*log10(f/20) dB for f (20MHz -> 200MHz)

Proposal for PSD mask

$$\text{Upper PSD}(f) = \begin{cases} -59.3 - 1.5 * \frac{f - 1}{19} & 300\text{KHz} < f < 20 \text{ MHz} \\ -60.8 - 3.7 * \frac{f - 20}{20} & 20 \text{ MHz} < f < 40 \text{ MHz} \\ -64.5 - 8.0 * \frac{f - 40}{17} & f > 40 \text{ MHz} \end{cases}$$

$$\text{Lower PSD}(f) = \begin{cases} -70.9 - 4.9 * \frac{f - 1}{19} & 300\text{KHz} < f < 20 \text{ MHz} \\ -75.8 - 13.4 * \frac{f - 20}{20} & f > 20 \text{ MHz} \end{cases}$$

Proposal for PSD mask

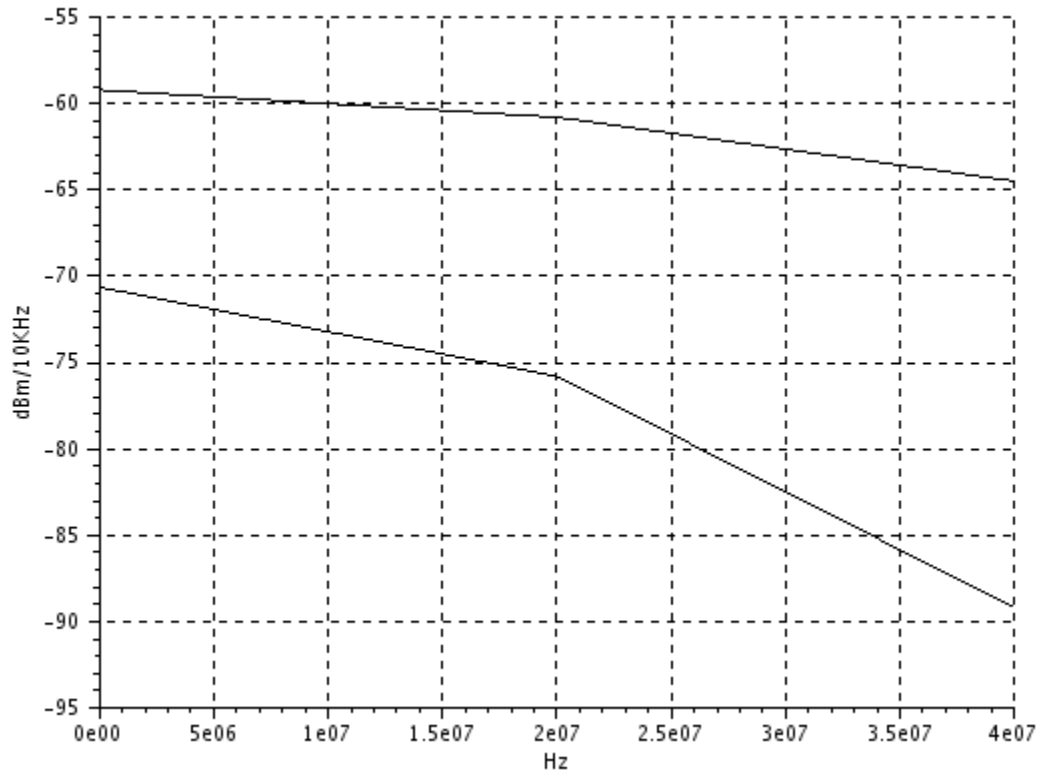

Proposal for PSD mask

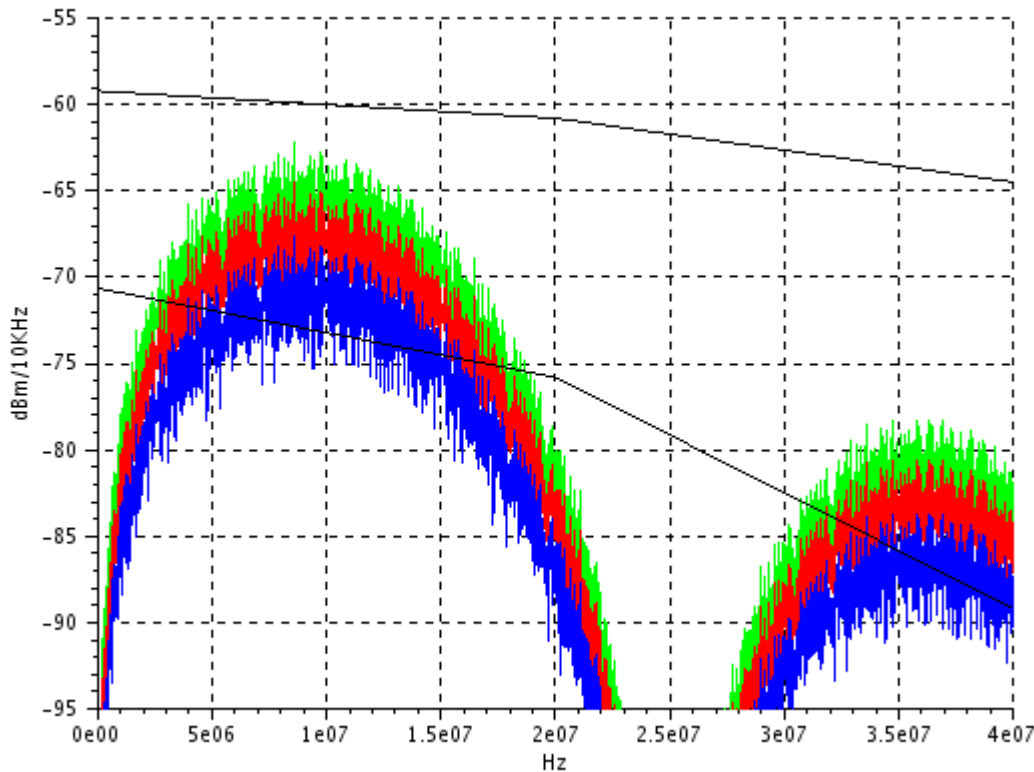

- Red: typ 1Vpp TX amplitude
- Green: +30% TX amplitude
- Blue: -30% TX amplitude

Simulations: EMI tests

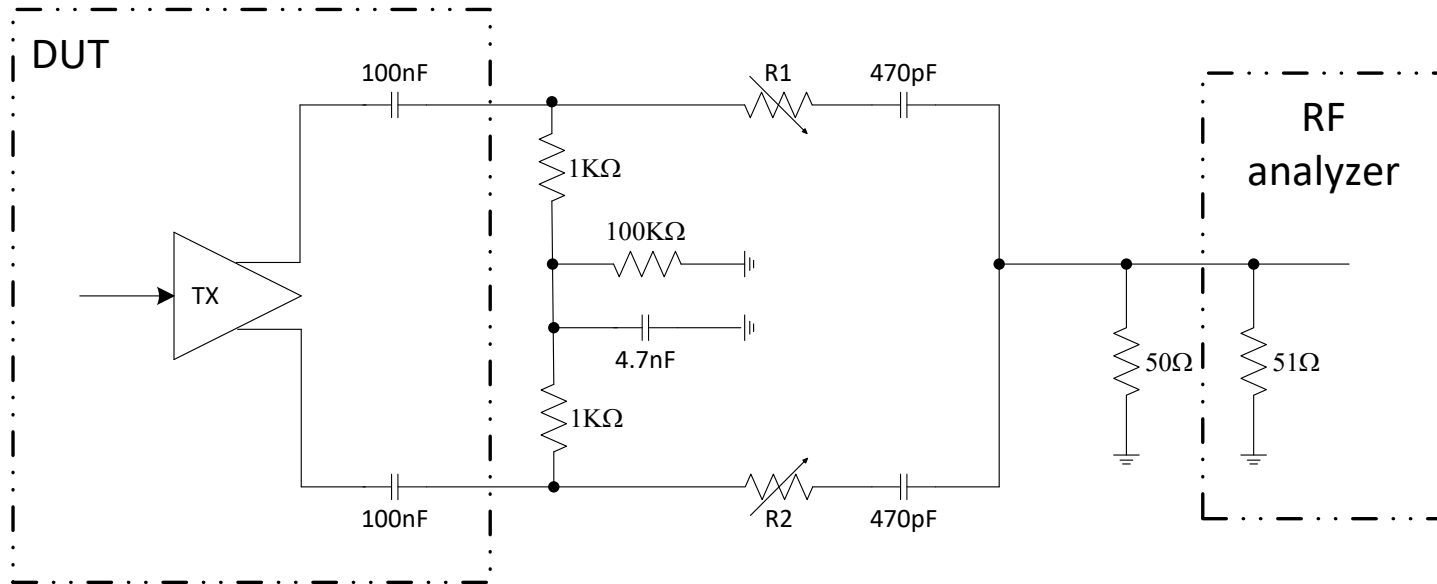

- **Direct Power Injection (DPI) and 150 Ohm emission tests for noise immunity and emission may be used to establish a baseline for PHY EMC performance**

Parameter coupling	R1 [Ω] (MDI P)	R2 [Ω] (MDI N)
Symmetry	120	120
+ 2.5 % unbalance	121	118
- 2.5 % unbalance	118	121
+ 5.0 % unbalance	121	115
- 5.0 % unbalance	115	121

EMI Requirements

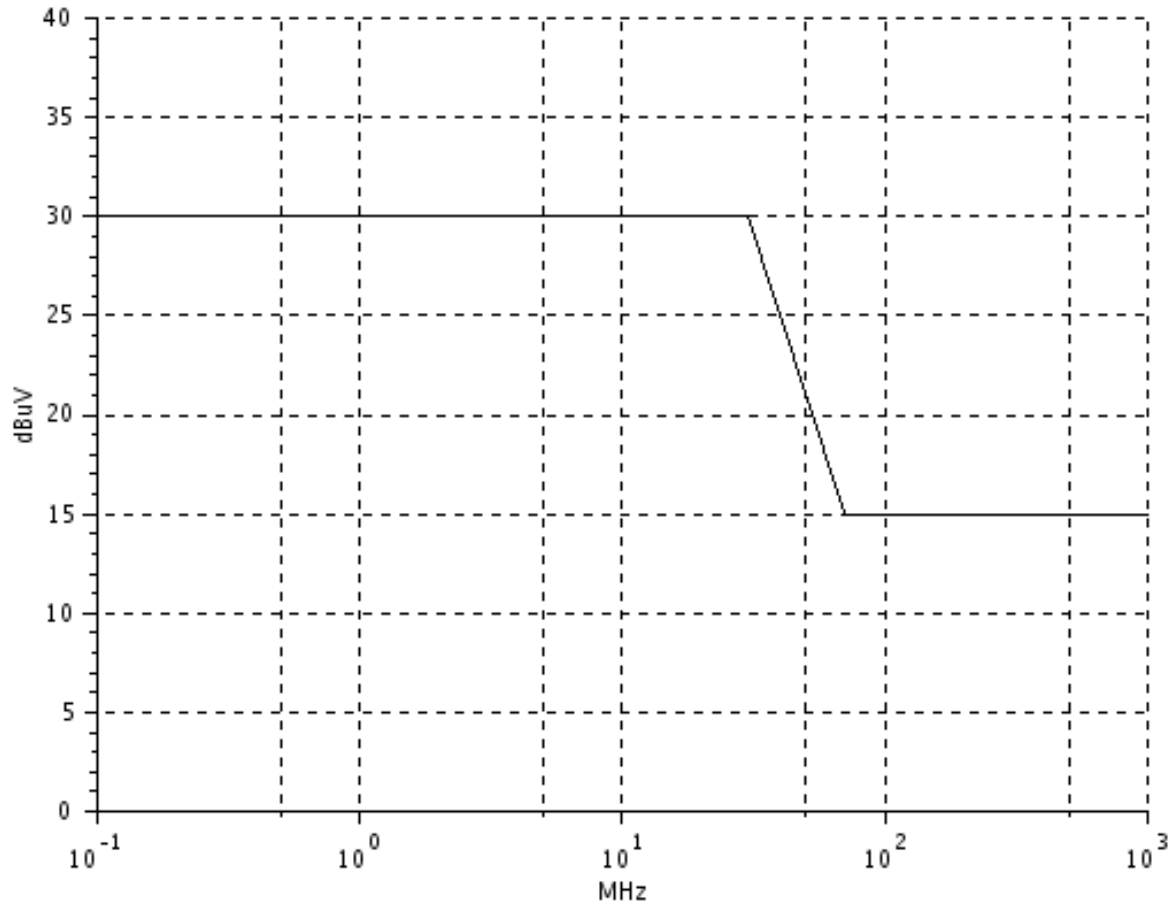

$f < 30\text{MHz} \Rightarrow 30\text{dBuV}$

$f > 70\text{MHz} \Rightarrow 15\text{dBuV}$

EMI Simulation $\pm 5\%$ unbalance, TX = 1 Vpp

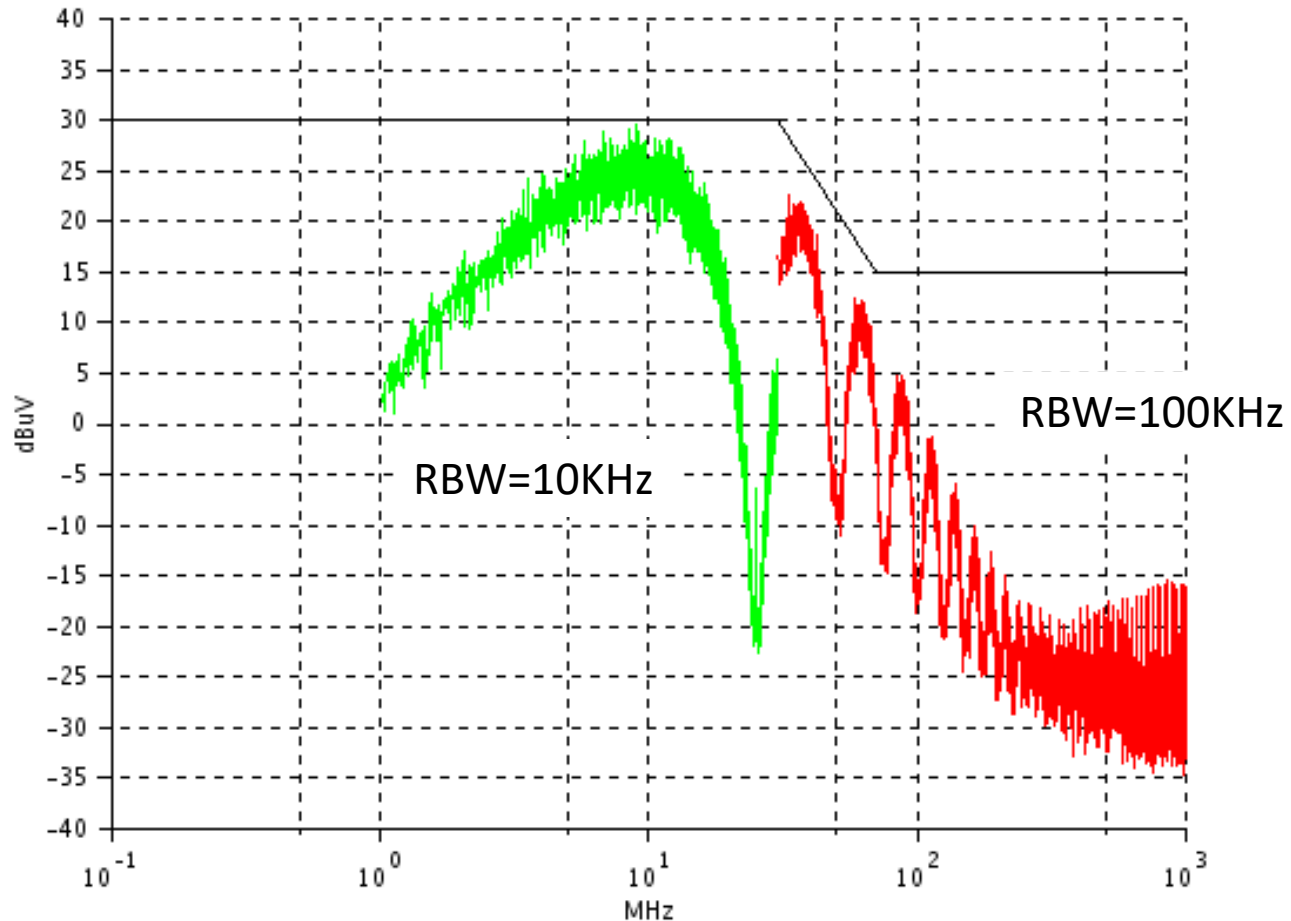

EMI Simulation $\pm 5\%$ unbalance, TX = 1.3 Vpp

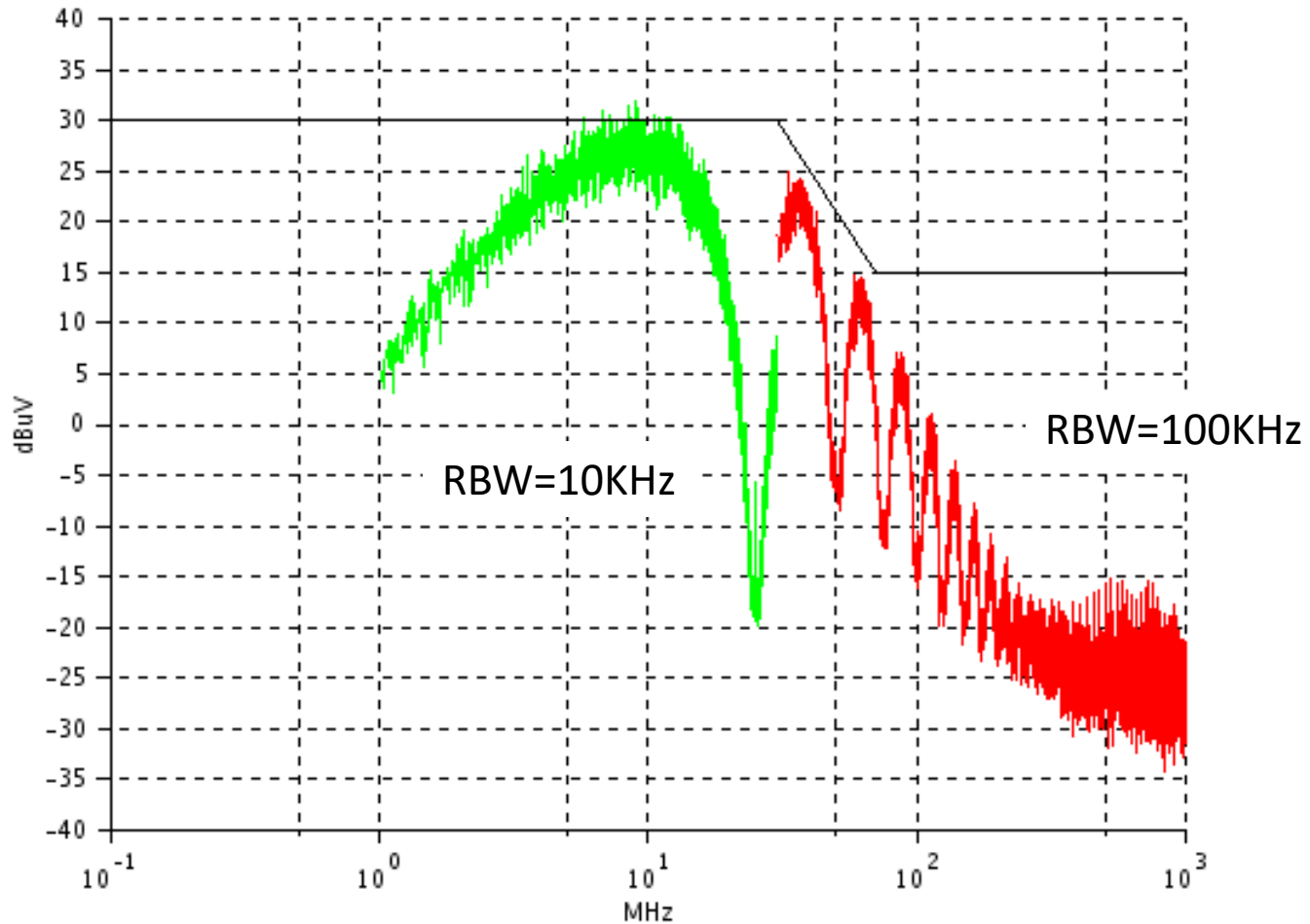

EMI Simulation $\pm 2.5\%$ unbalance, TX = 1.3 Vpp

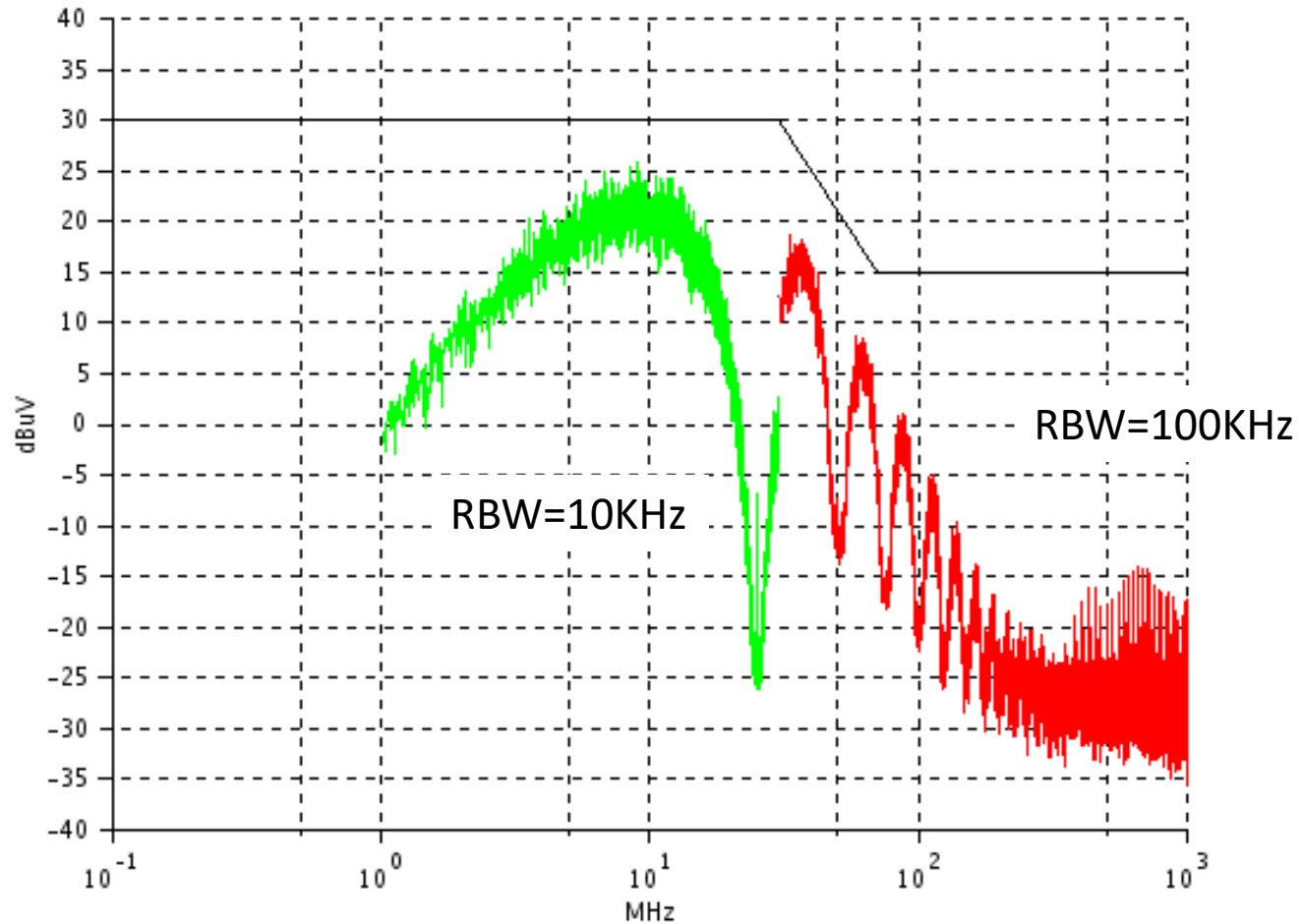

Simulations: Multidrop mixing segment Test Bench

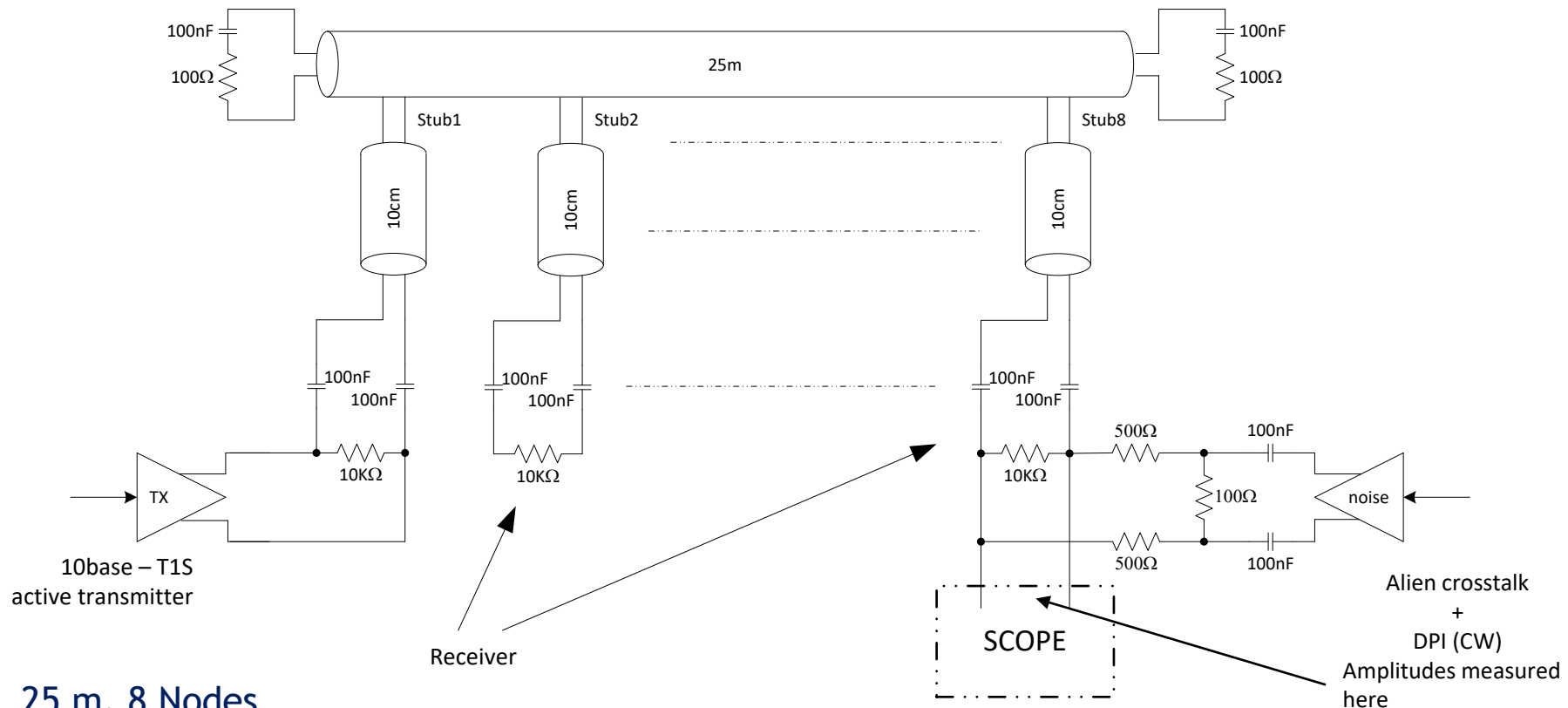

- 25 m, 8 Nodes
- $100\Omega \pm 1\%$ line termination resistance
- $50\Omega \pm 20\%$ transmitters (high-Z when silent)
- MC 43dB, 36.5dB and 30dB (comparison)

- BCI: Severity Class IV :30dBm for 3-200MHz
- 50mVpp Alien noise considered
- MC = 43dBm
 - BCI injected noise = 140mVpp
 - BCI + Alien noise = 190mVpp

- MC = 36.5dBm
 - BCI injected noise = 300mVpp
 - BCI + Alien noise = 350mVpp
- MC = 30dBm
 - BCI injected noise = 630mVpp
 - BCI + Alien noise = 680mVpp

Simulations: mixing segment RL, IL

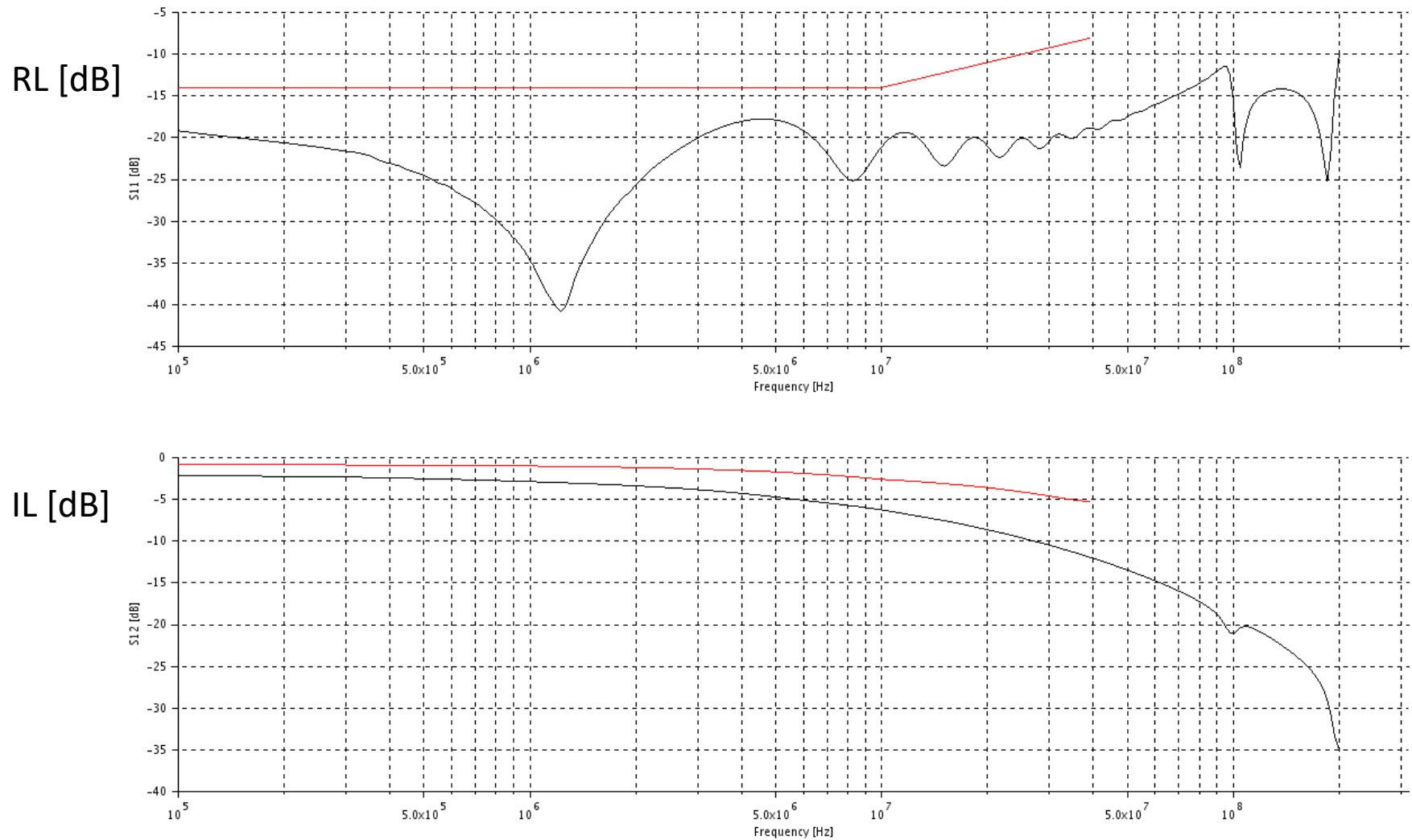

Mixing segment with 50mVpp Alien Noise

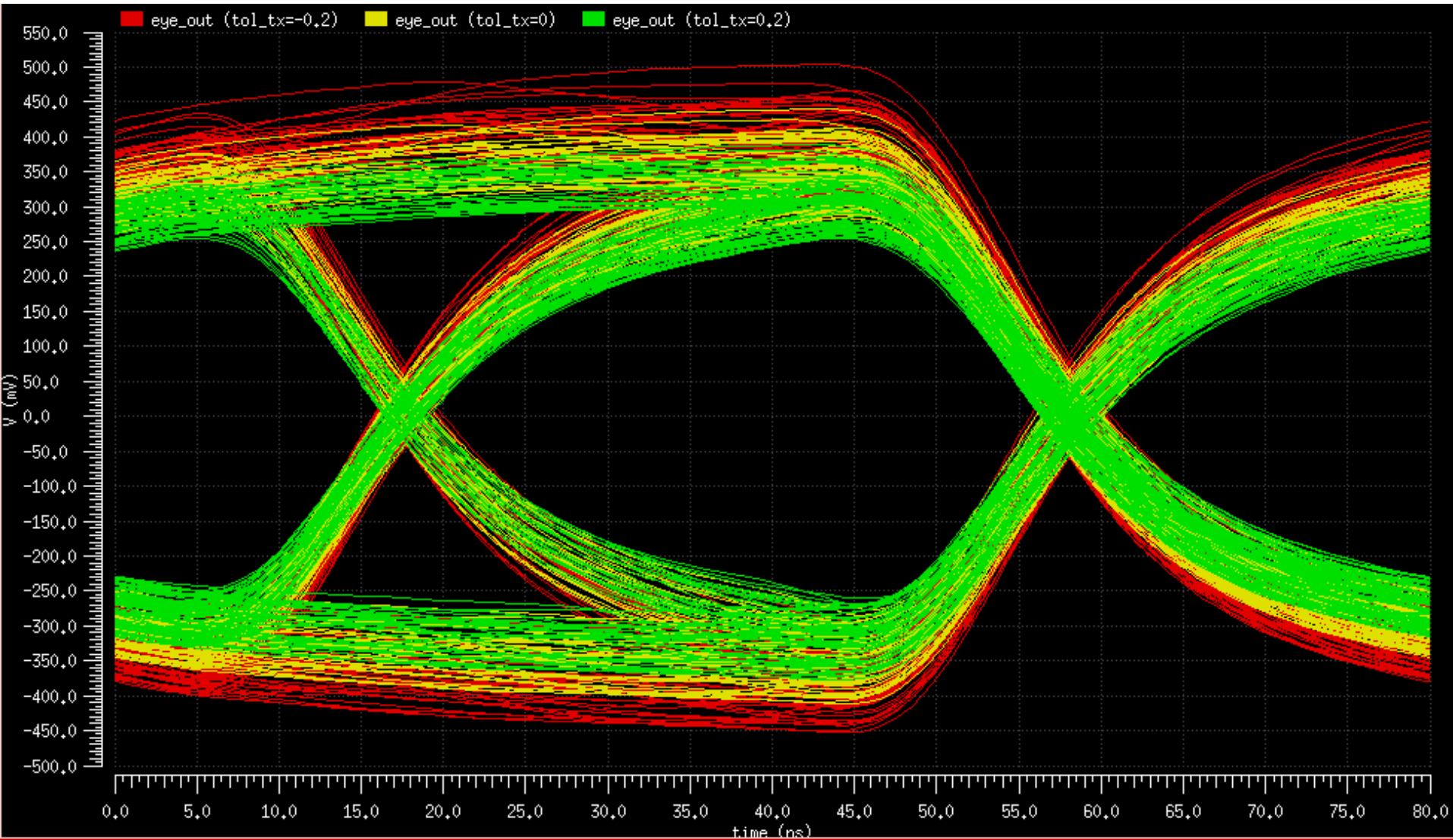

Mixing segment with 50mVpp Alien Noise + DPI (30dbm) and MC = 30dB (total = 680mVpp)

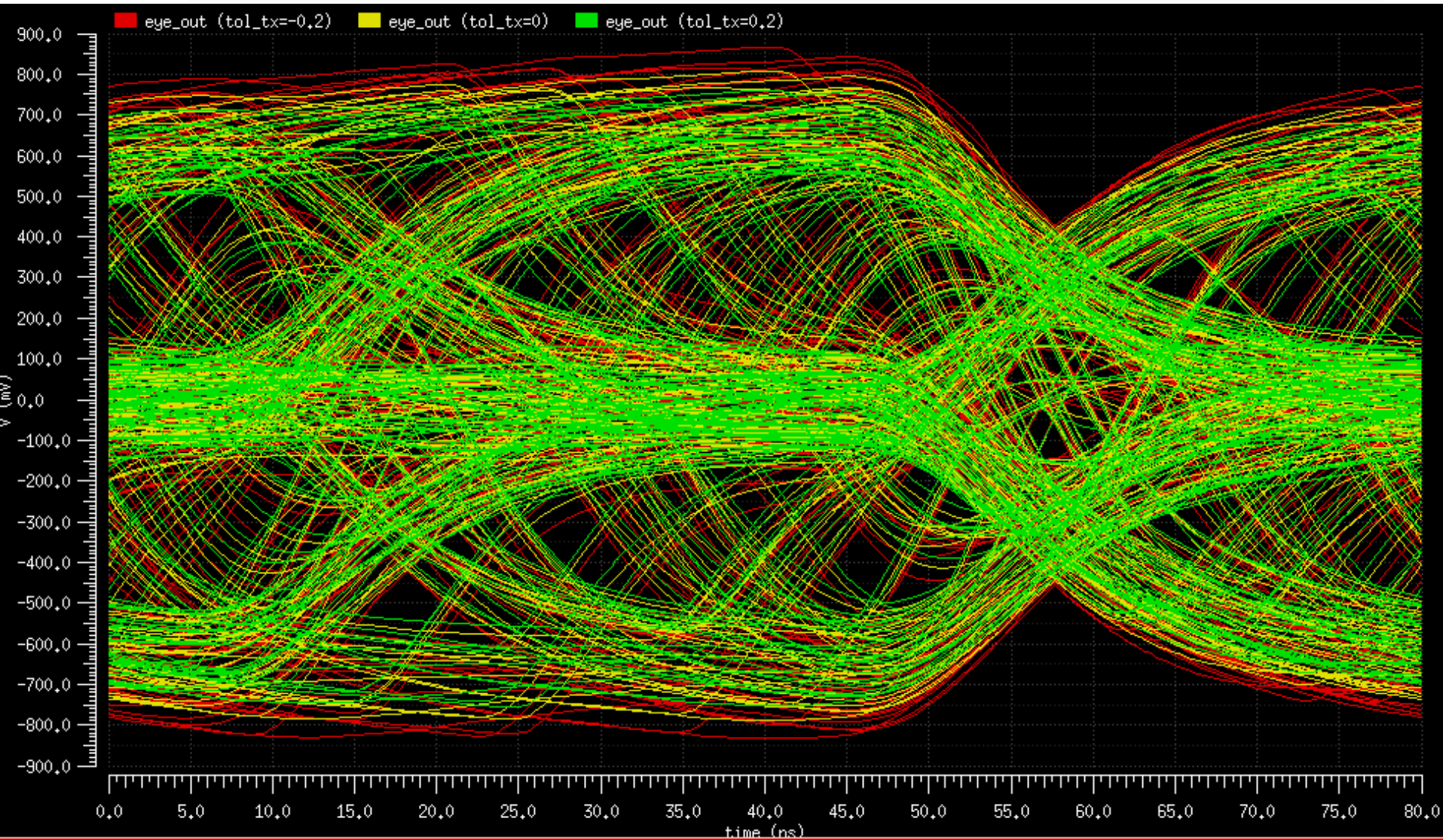

Mixing segment with 50mVpp Alien Noise + DPI (30dbm) and MC = 36.5dB (total = 350mVpp)

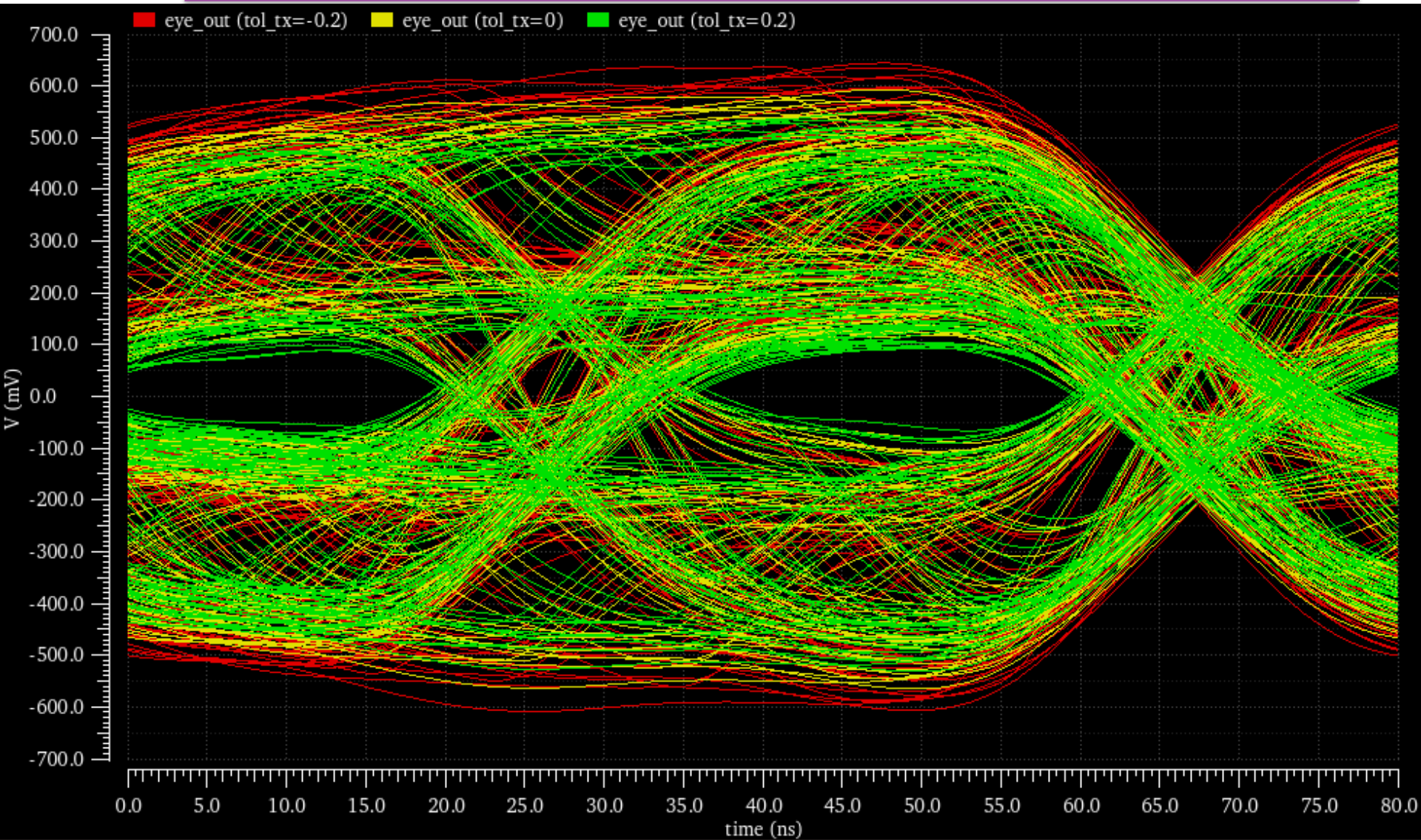

Mixing segment with 50mVpp Alien Noise + DPI (30dbm) and MC = 43dB (total = 190mVpp)

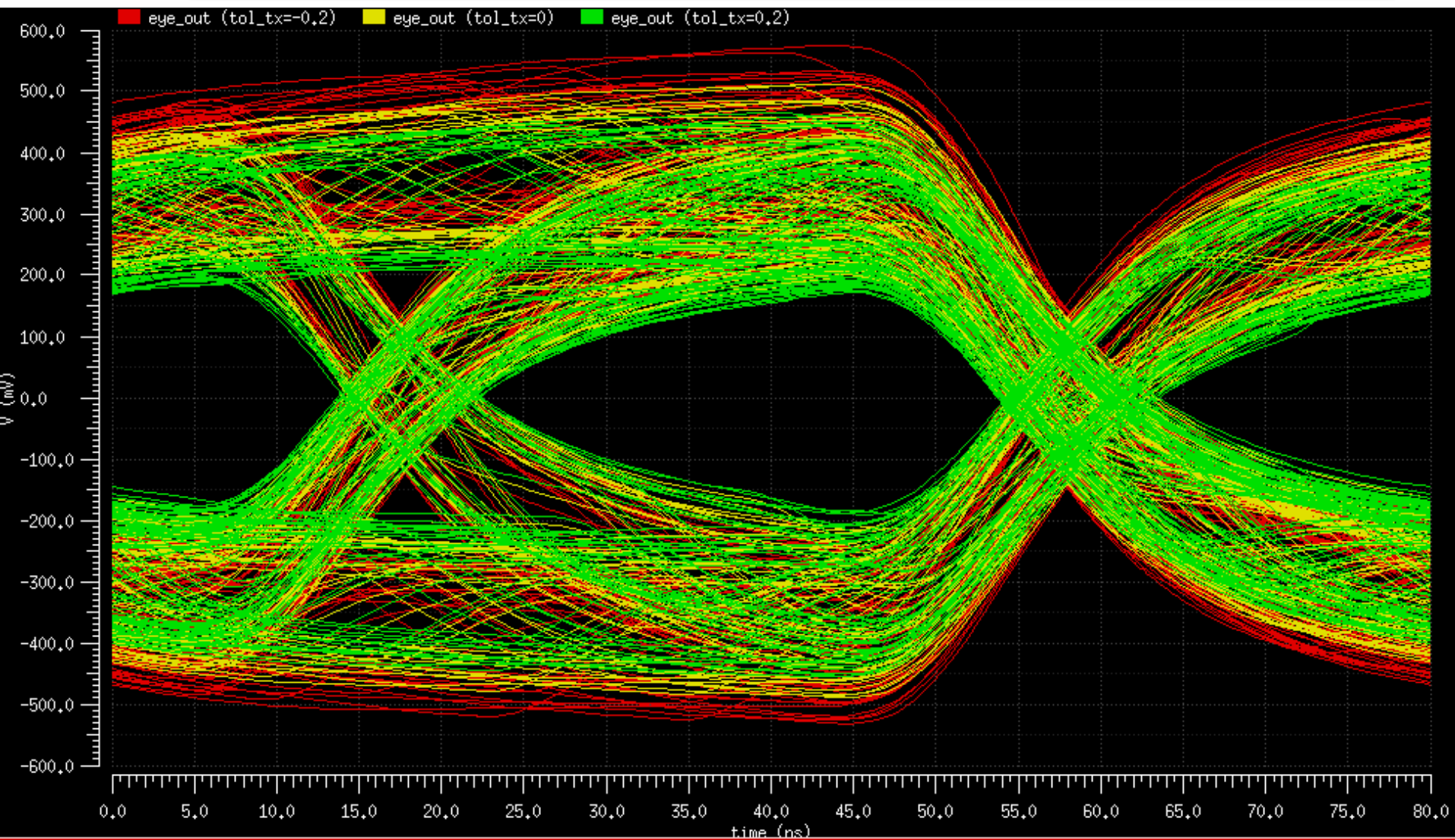

Mixing segment with 2Vpp TX + 100mVpp Alien Noise + DPI (30dbm) and MC = 30dB

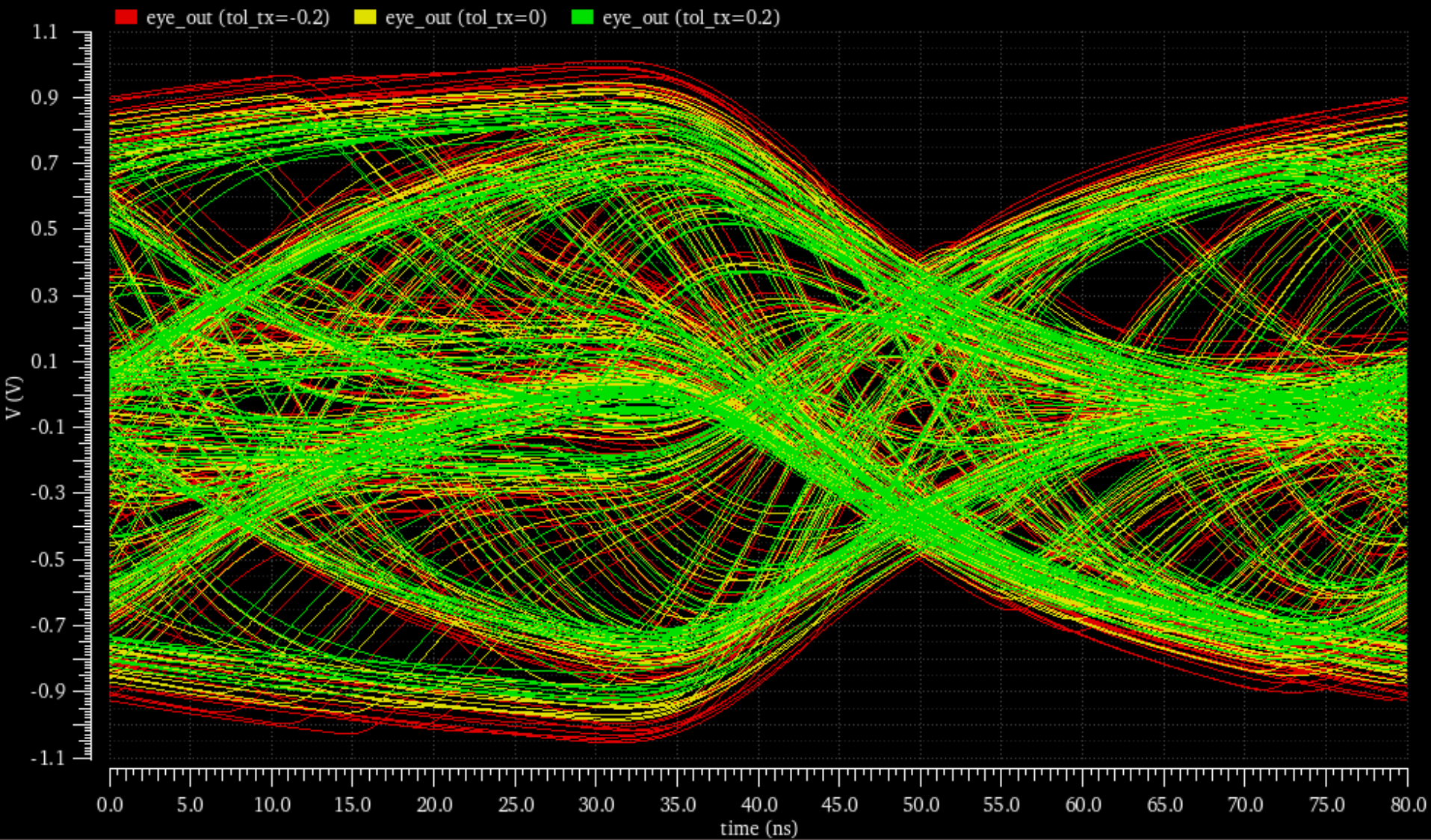

- **30dB MC seems unreasonable**
 - Increasing TX amplitude by 2x is not a solution
 - EMI likely out of specs anyway
- **36.5dB MC seems better but yields poor margin**
- **43dB (as in 802.3bw) looks safe**
- **Proposed change for TIS link segment / mixing segment definition**