

Very Small Form Factor (VSFF) Fiber Optic Connectors

Tom Mitcheltree US Conec

IEEE 802.3db 100 Gb/s, 200 Gb/s, and 400 Gb/s Short Reach Fiber Task Force
Ad Hoc Teleconference, 9 July 2020

What are Very Small Form Factor (VSFF) connectors?

Duplex LC

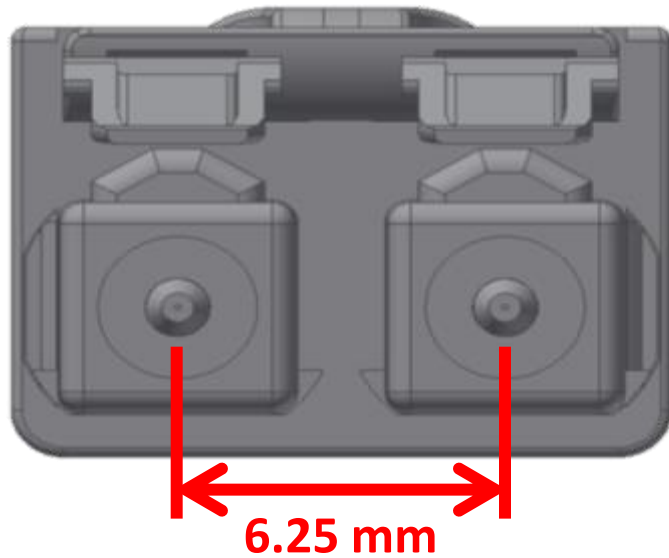

Reduced ferrule pitch increases fiber density over LC Duplex

VSFF

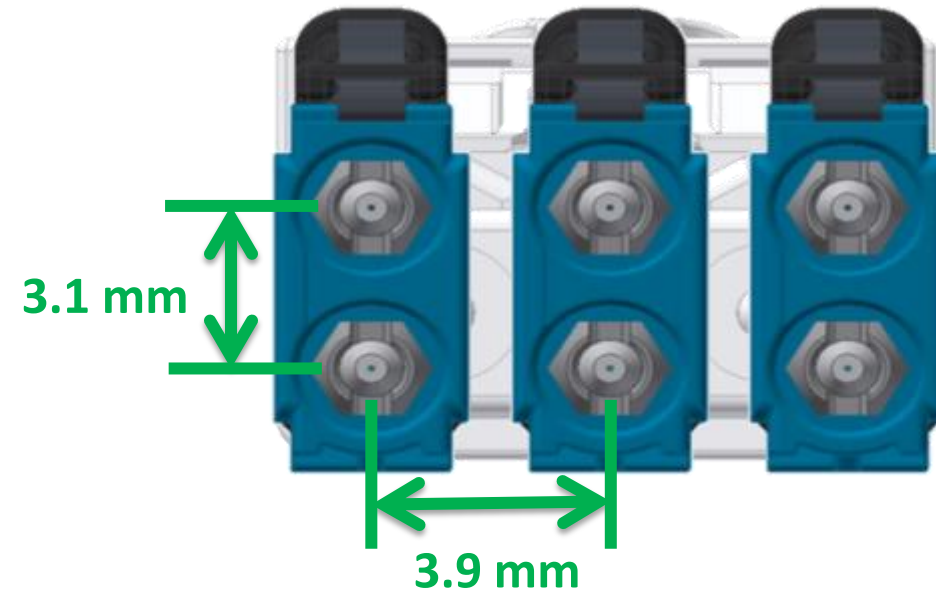

3x density increase in the same LC Duplex footprint

Why are VSFFs needed?

Current duplex connectors do not support

- 4 duplex connectors in a single QSFP-DD package
- 2 duplex connectors in a single SFP-DD package

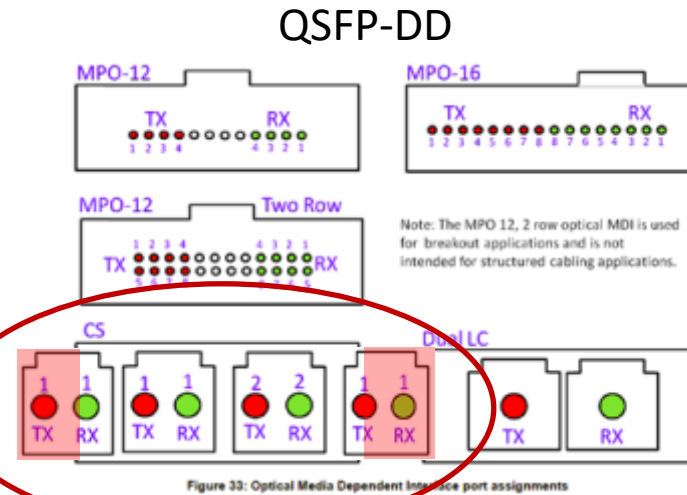

QSFP-DD/OSFP 4:1 breakout: **X**

SFP-DD 2:1 breakout: **X**

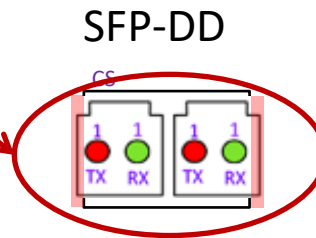

Source: QSFP-DD MSA
SFP-DD MSA

A smaller format duplex connector is needed to support QSFP-DD/OSFP 4:1 and SFP-DD 2:1 breakout applications.

VSFFs support future breakout applications

...support these new breakout applications!

QSFP-DD/OSFP 4:1 breakout: ✓

SFP-DD 2:1 breakout: ✓

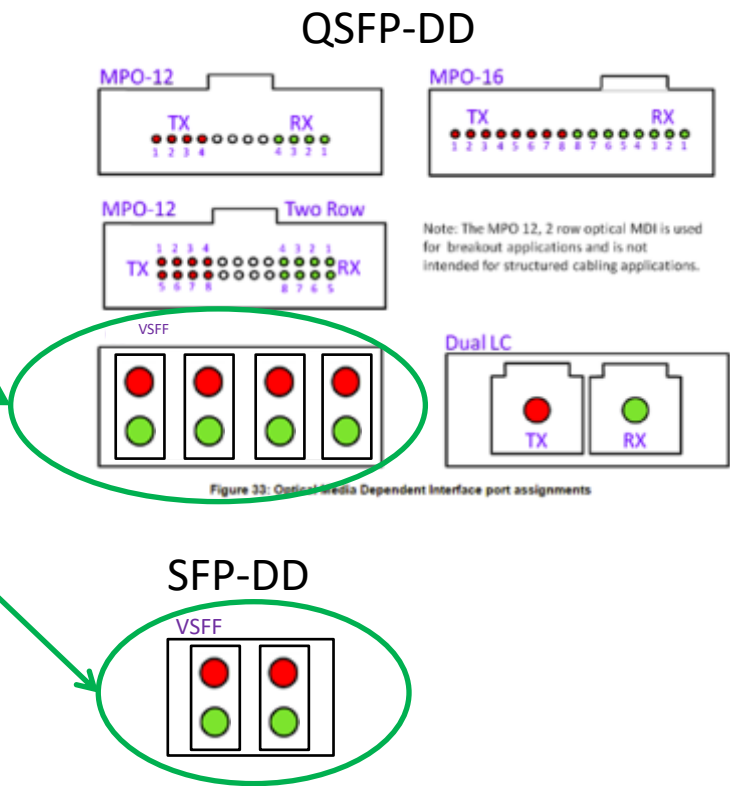

Source: QSFP-DD MSA
SFP-DD MSA

VSFFs Support All 3 IEEE 802.3db Use Cases

IEEE 802.3db Objectives: Define a physical layer specification that supports...

#8: 100 Gb/s operation over 1 pair of MMF ✓

SFP-DD

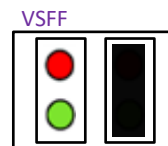

QSFP-DD/OSFP

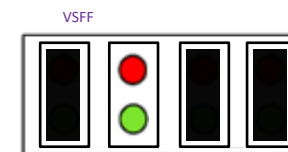

#9: 200 Gb/s operation over 2 pairs of MMF ✓

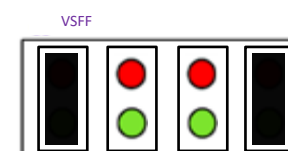
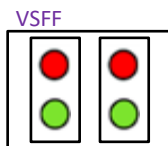

#10 400 Gb/s operation over 4 pairs of MMF ✓

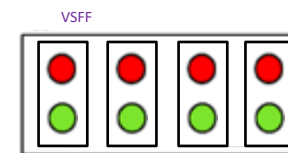

What are the requirements? Feedback from the industry thus far...

- Two 1.25 mm ferrules in single connector housing with a 3.1mm pitch
 - Leverage existing LC ferrule/spring
 - PC and APC variants
- Same performance as LC
 - IL & RL
 - GR-326 ENV & MECH performance standard
- Standard 2-fiber cable
 - 2.0 mm OD or less
- Simple for Transceivers to Integrate
 - Miniature variant for inside transceiver
- Ergonomic Insertion/Extraction
- Field Polarity Change
- Ganged Options / Scalability

Applicable VSFF connector standards

MSA	VSFF	Standard
QSFP-DD, SFP-DD, OSFP	SN	IEC 61754-36
QSFP-DD, SFP-DD, OSFP	MDC	IEC 61754-37



Simplicity for Transceivers

Receptacle specification is publicly available

<http://www.qsfp-dd.com/wp-content/uploads/2020/02/MDC-Receptacle-Interface-Specification-Rev-4.pdf>

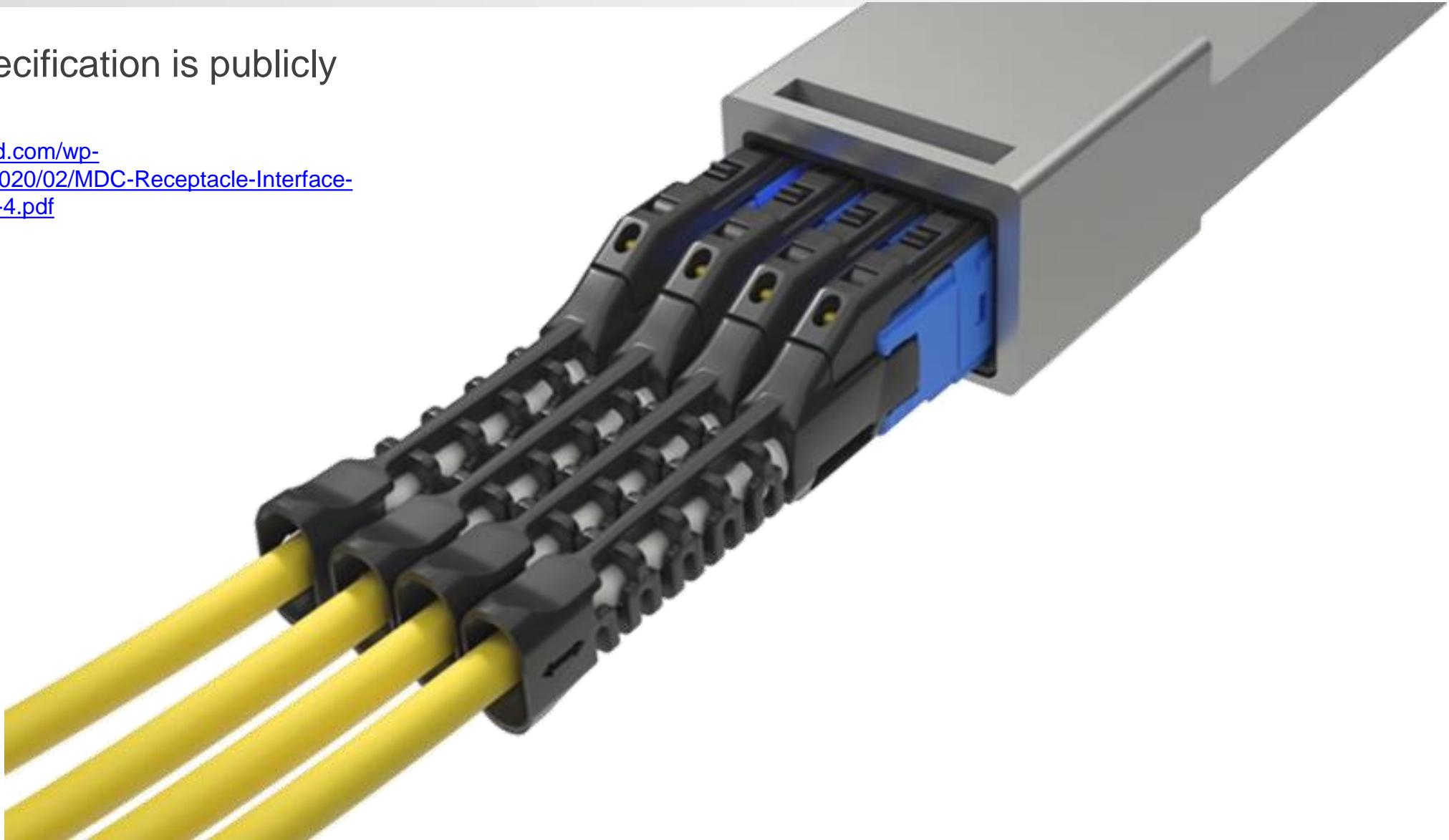

Miniature VSFF Variant for Inside Transceiver

MDC Internal Connector

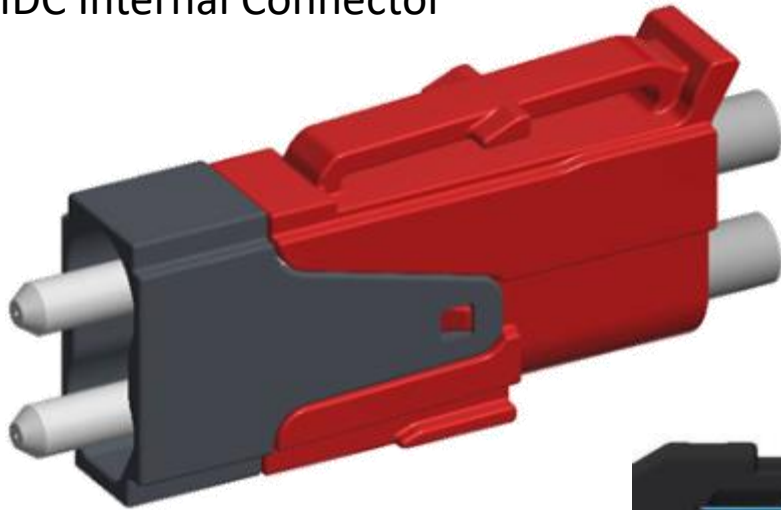

MDC Internal Connector

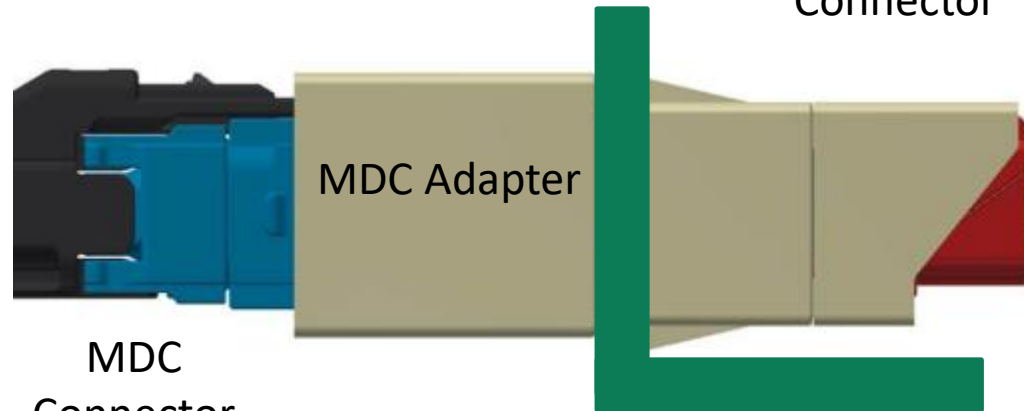

MDC Connector

MDC Adapter

Panel or Module

Ergonomic Insertion/Extraction

- Due to their small size, ergonomics are critical in the adoption of VSFFs
 - In many use cases, the operator will not be able to hold the connector body to insert/extract
- The Solution = Push/Pull Boot:
 - Flexible enough to access middle ports without disturbing adjacent neighbors
 - Rigid enough to enable insertion



Polarity can be changed in the field with no tools

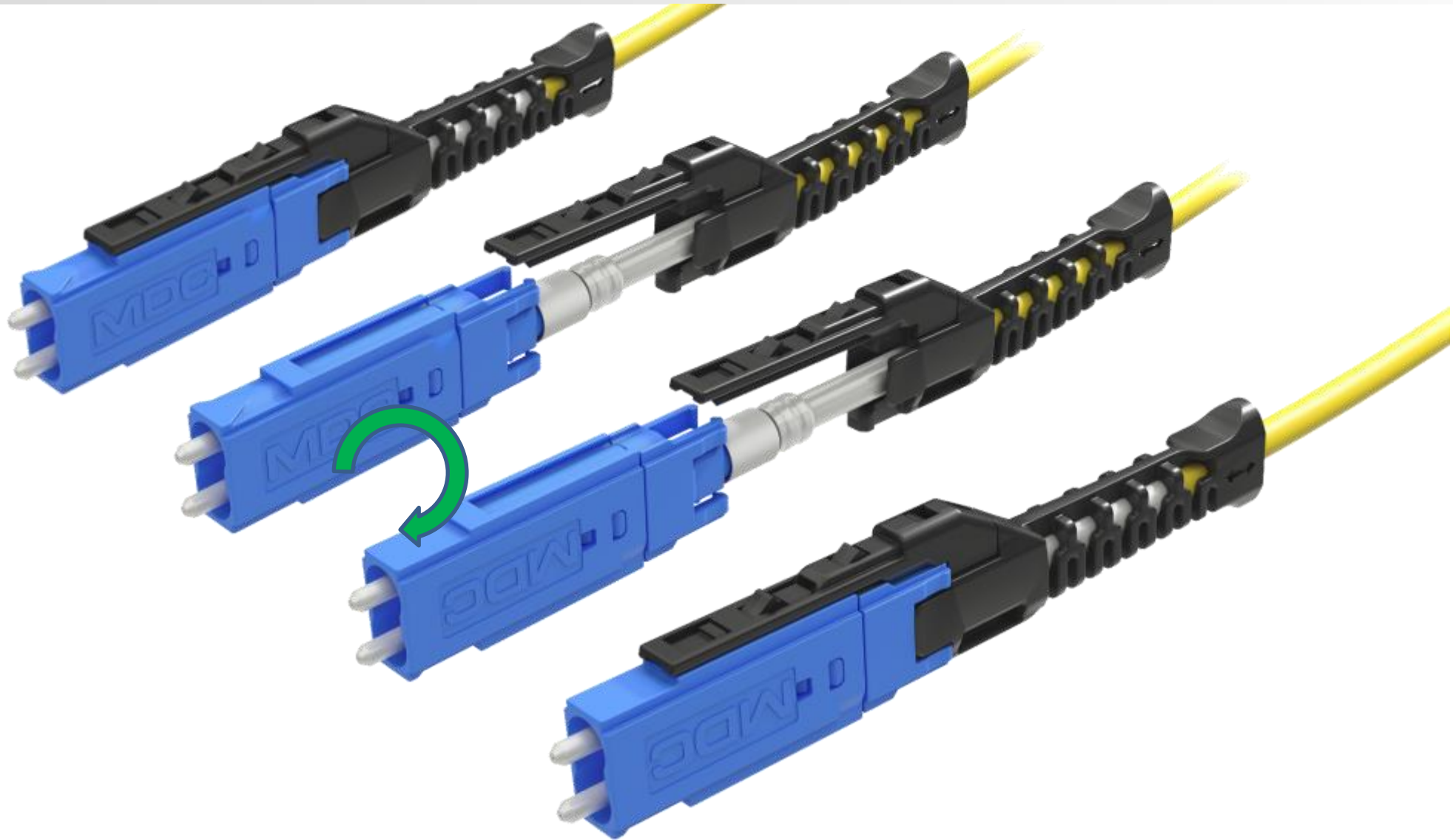

APC Variant

Applications Requiring Lower Reflectance



Opposing
Angled
Endfaces

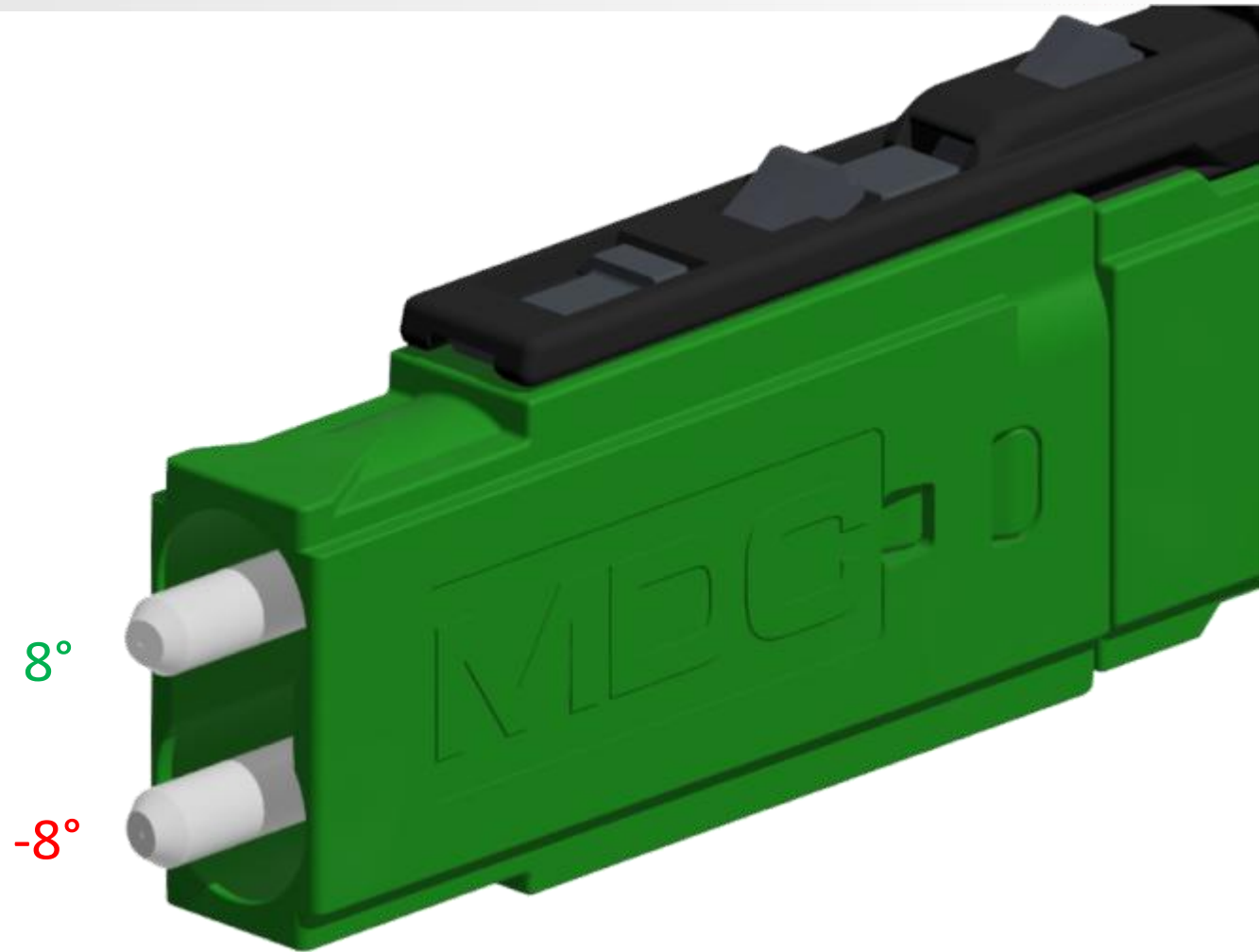

Same Toolless Polarity Reversal Process as PC Connectors

Scalable Platform: Ganged Variants (8f & 2f)

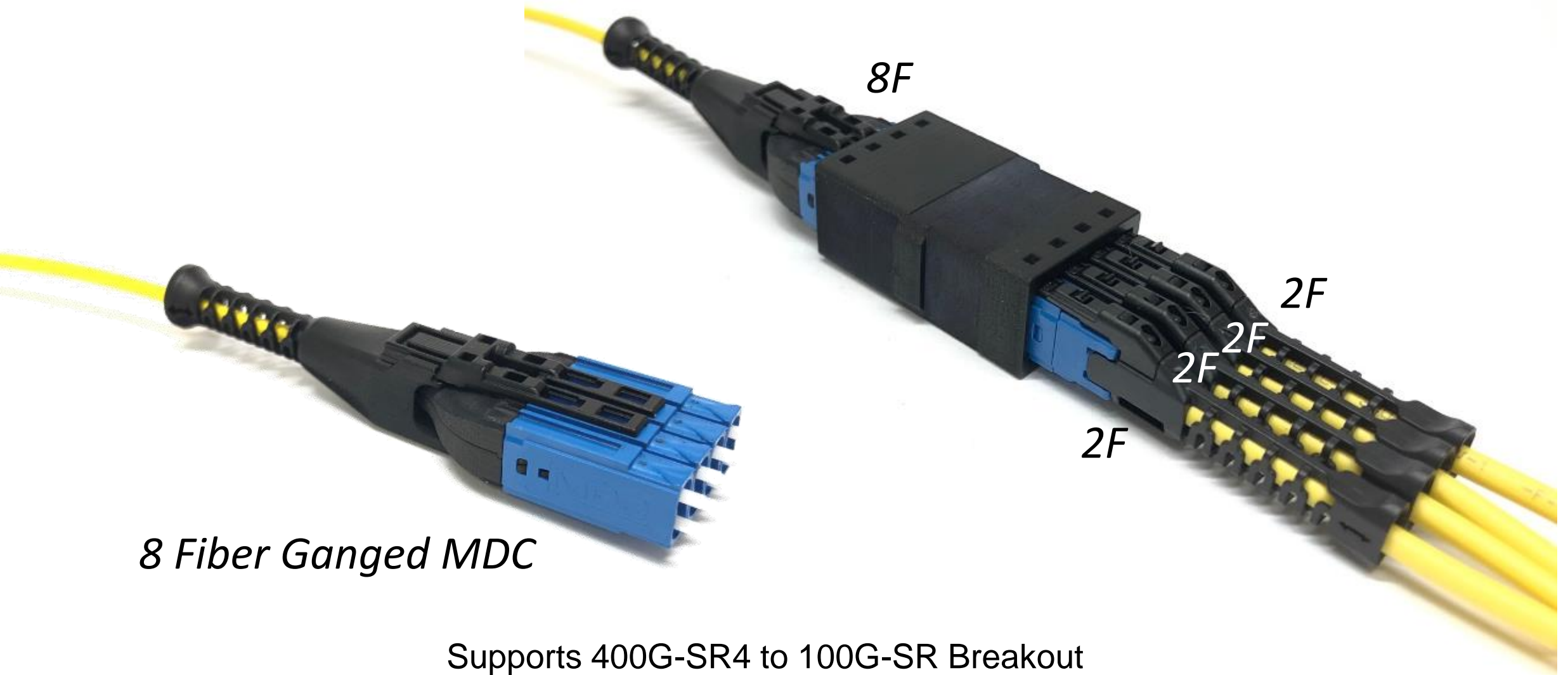

8 Fiber Ganged MDC

Supports 400G-SR4 to 100G-SR Breakout

Scalable Platform: Ganged Variants (8f & 4f)

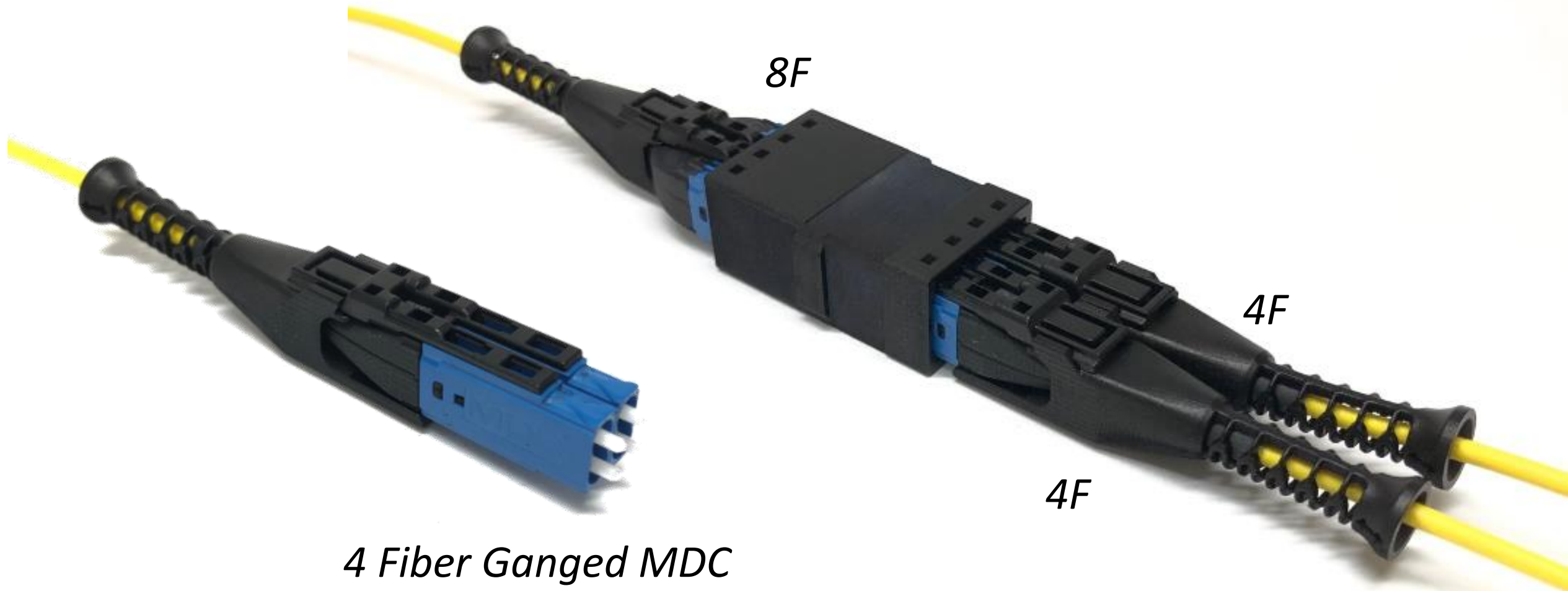

4 Fiber Ganged MDC

Supports 400G-SR4 to 200G-SR2 Breakout

Summary

- VSFF fiber optic connectors are an enabling technology for future breakout transceivers
- MSA communities and individual end users have provided feedback on VSFF requirements
- VSFF manufacturers seek IEEE's feedback on any additional requirements

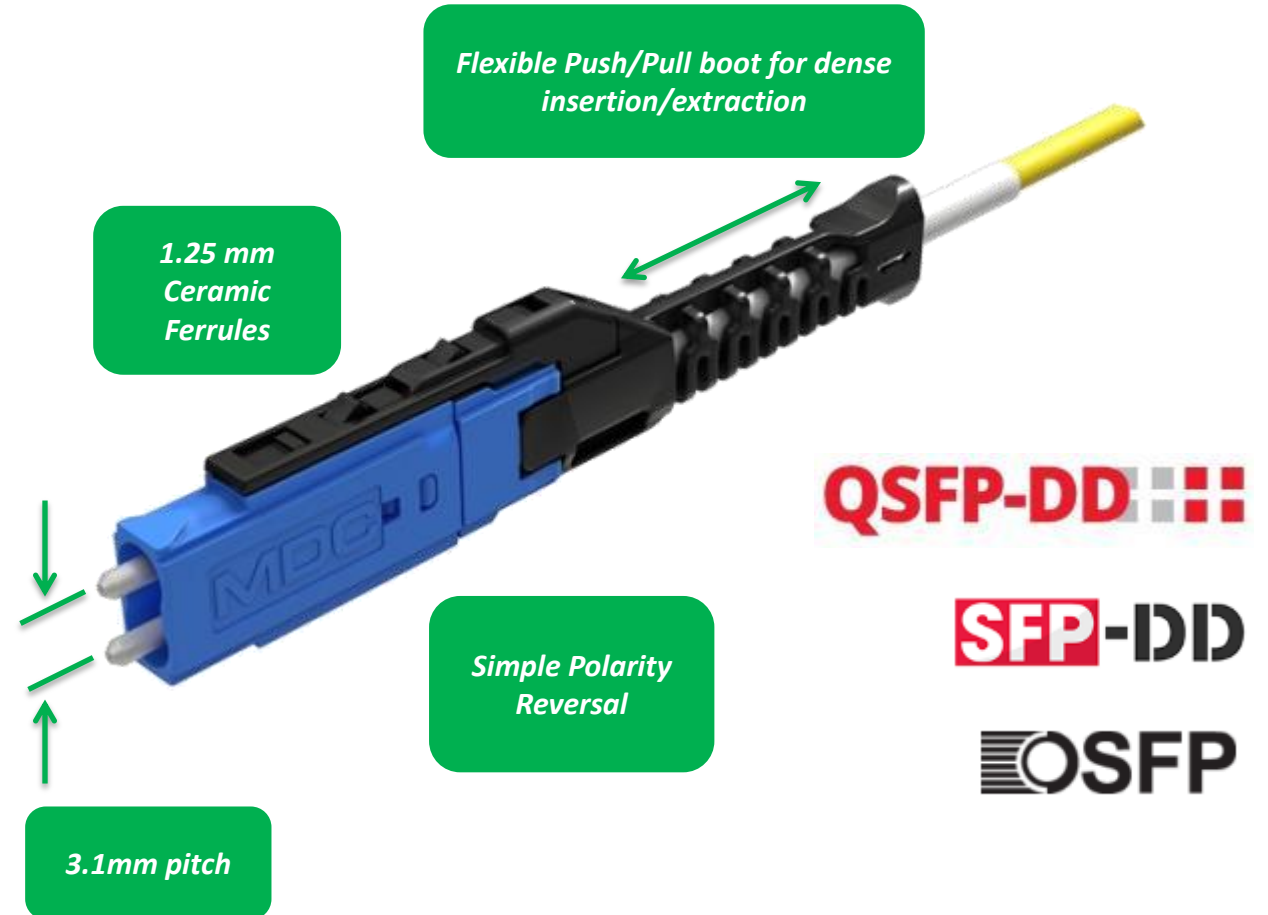

tommitcheltree@usconec.com

THANK YOU