

# Evolution of 200G PMDs and AUIs with Concatenated FEC

Ali Ghiasi, Ghiasi Quantum/Marvell

802.3df Task Force Meeting

Montreal

July 12, 2022

# Overview

- ❑ Different classes of AUI
- ❑ Evolution from 100G AUI to 200G AUI
- ❑ Scaling BS FEC architecture to DF
- ❑ 1<sup>st</sup> Gen host with 1<sup>st</sup> Gen PMDs
- ❑ 1<sup>st</sup> Gen host with 2<sup>nd</sup> Gen PMDs
- ❑ 2<sup>nd</sup> Gen host with 2<sup>nd</sup> Gen PMDs
- ❑ Summary.

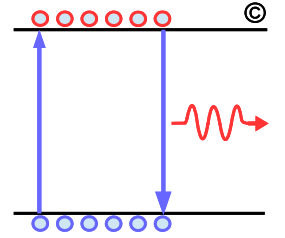

# How to Define 200G/lane Optical PMDs Prior to 200G/lane AUIs

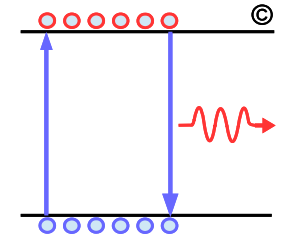

- **Early data indicate potential feasibility even conventional 200G-AUI to operate at pre FEC BER of 1E-5**
  - Nonconventional AUI with Flyover Cu and co-packaged expect to operate at 1E-5 BER with simpler equalizer
  - Nonconventional AUIs expect to operate on the electrical segments at 1E-5 pre-FEC BER with end-end RS (514,544) FEC for both 100G and 200G optical PMDs
  - 200G optical PMDs with SFEC in the module based on interleaver will have 1.35-2.95 dB of additional NCG, see [bliss\\_3df\\_01a\\_220517](#)
  - Conventional 200G-AUI due to high loss and ILD may benefit operating at 1E-4
- **Based on early data on 200G-AUI and 200G-CR with addition of SFEC with high confidence we can follow 802.3bs architecture that operated with an end-end FEC and by allocating 0.1-0.2 dBo to electrical sub-links**
  - There are potentially 3-4 types of AUIs some expect to operate with end-end FEC with 0.1-0.2 dBo allocation to the electrical sublinks
  - With emergence of optics/Cu co-packaging there are more implementation options than traditional AUIs
  - Some of the optics co-packaging may use low speed parallel buses, PPIs, or even PMD interfaces
  - It is plausible that future 200G system may not have any conventional PCB based AUIs
- **Conventional 200G AUI expect to be have substantially higher loss, ILD, and reflections**
  - 802.3df should not tax everyone for implementation that may not get used broadly
  - Segmented FEC based on termination of KP4 FEC in the module is an option that may be required
- **SFEC+KP4 provides seamless migration from Gen 1 host (100G-AUI) with Gen 1 optics (100G/lane), to Gen 1 host (100G-AUI) with Gen 2 optics (200G/lane), to Gen2 host (200G-AUI) with Gen 2 optics (200G/lane).**

# AUI and PPI Interfaces

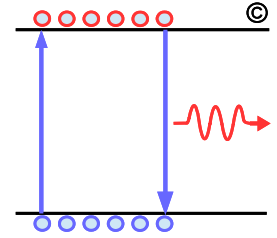

❑ XSR/Direct drive generally require optics engine to be bumped and the interface is an engineered analog drive – not an AUI interface

– Within the scope of 802.3df we have potentially up to 4 AUI classes and as few as 2 classes!

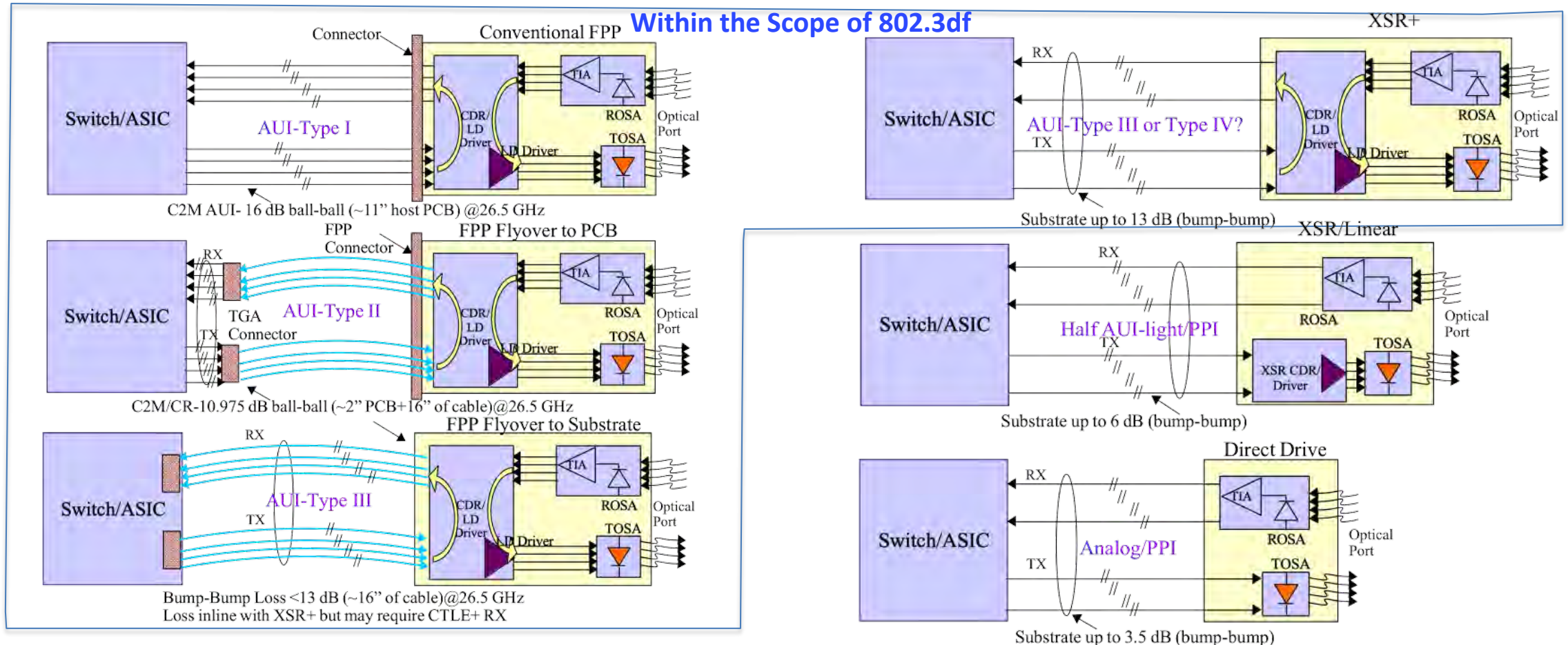

# Potential Evolution of AUI from 100G to 200G

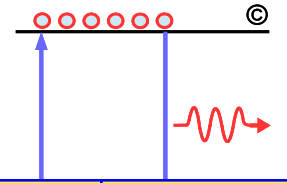

## Conventional C2M (AUI Type-I)

- Min required PCB assumed 10" drives the loss budget at 200G
- Likely need to increase loss from 16 dB to 21 dB
- Likely require terminated FEC

## CR/C2M (Subset of AUI-I/II/III)

- Max CR loss of 10.975 dB TP0-TP2 drives the loss budget for dual use port
- Type II can be an implementation of Type I or Type III
- Conventional PCB not practical but 5.975 dB loss will support 300 mm Flyover cable
- Operate with end-end FEC

## NPO/CR with Flyover cable (AUI-III)

- 75 mm NPO substrate + 300 mm cable drives the loss of 11 dB
- Budget is nearly identical to CR/C2M and can be merged with CR/C2M
- Operate with end-end FEC

## NPO (AUI Type-IV)

- Min 75 mm/ 3" drives the loss for 200G NPO
- Operates with end-end FEC.

Can be Merged

53 GBd (26.55 GHz) AUIs	C2M	CR/C2M	NPO
TP0-TP1a Loss (dB)*	16	10.975	~7
PCB/Substrate Loss (dB)	11.9	6.875	~7*
Bump-TP1a Loss (dB)	20	14.975	~11**
Bump-Bump Loss (dB)	~22	~16.975**	13
Loss Adv PCB(C2M) or HDI(NPO) dB/in	~1.1	~1.1	~1.8
PCB/HDI Length Supported (in)	~10.8	~6.25	~3.8

\*Assume 1<sup>st</sup> level package loss 4 dB. \*\* PMA package loss assumed 2 dB.

~110 GBd (55 GHz) AUIs	C2M	CR/C2M	NPO	NPO/CR
TP0-TP1a Loss (dB)*	21	10.975	~6.75	16
PCB/Substrate Loss (dB)	16	5.975	~6.75*	11.0
Bump-TP1a Loss (dB)	26	15.975	~11.75**	16
Bump-Bump Loss (dB)	~28.5	~18.475**	14.25	18.5
Loss Adv PCB/HDI/Cable (dB/in)	~1.6	~1.6	~2.25	~0.45
PCB/HDI Length Supported (in)	~10 (PCB)	~3.7 (PCB)	~3 (HDI)	~12 (cable)

\*Assume 1<sup>st</sup> level package loss 5.0 dB. \*\* PMA package loss assumed 2.5 dB.  
Package assumption here are very aggressive and require improved material and wider traces.

# 802.3bs FEC Architecture Can be the Template for 802.3df

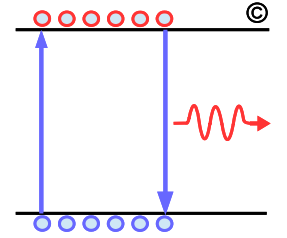

□ 802.3df task force need to define a new 200G/lane optics FEC with 0.1-0.2 dBo reserved for PMA/PMD/PPI sub-links as shown below

- SFEC+RS(514,544) allow seamless upgrade of 100G-AUIs to 200G/lane optics without rate increase on the 802.3ck interfaces
- It is also expected the end-end SFEC+RS(514,544) to support a range of AUIs plus optical PMDs
- Conventional AUI based 10" host PCB loss will be 16\* dB (~1.6 dB/in) may require FEC termination
  - Expect to push 100G-AUI bump-bump loss to 28.5 dB!

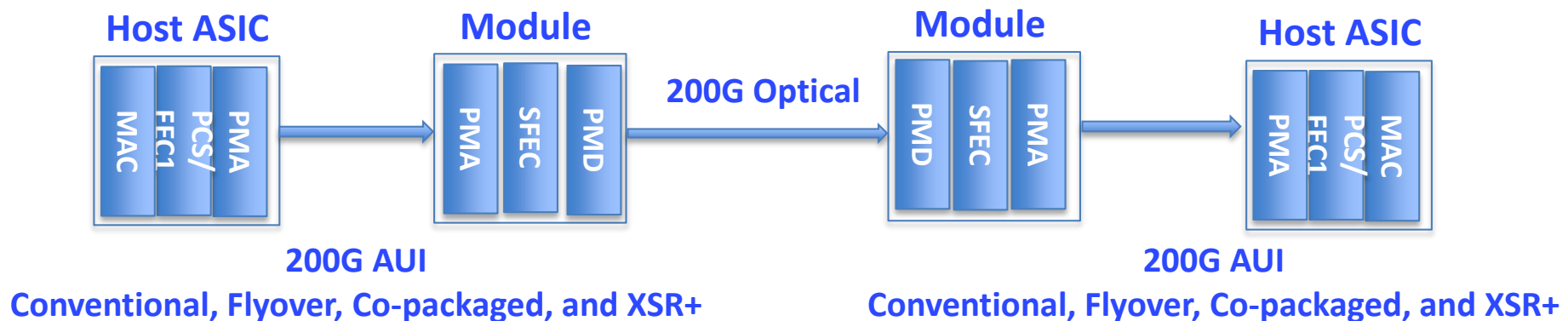

\* Assumes 6.5 mils wide striplines with DK=3.0, DF=0.0015, 1 μm finish.

# 1<sup>st</sup> Generation 800 GbE Systems Based on 100G AUI

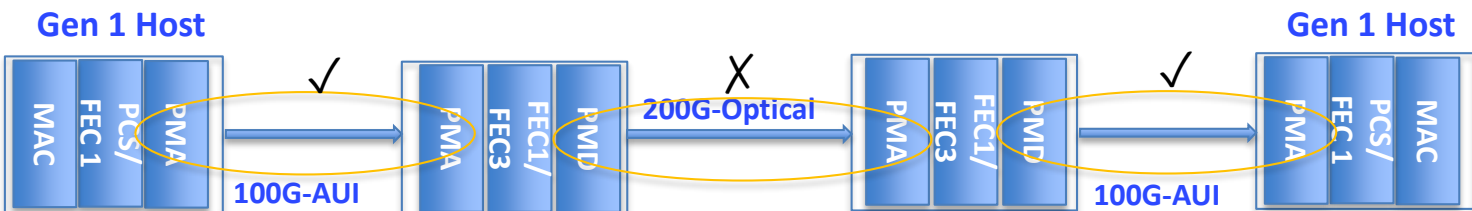
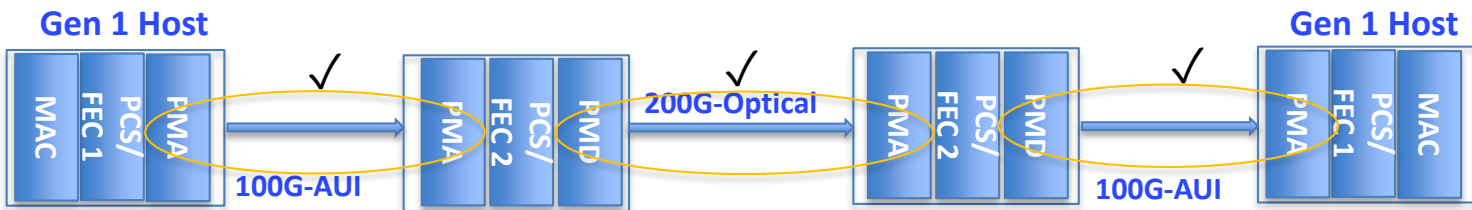
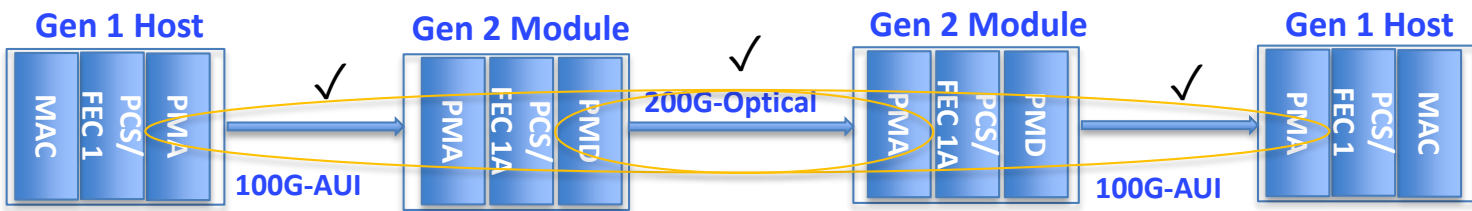
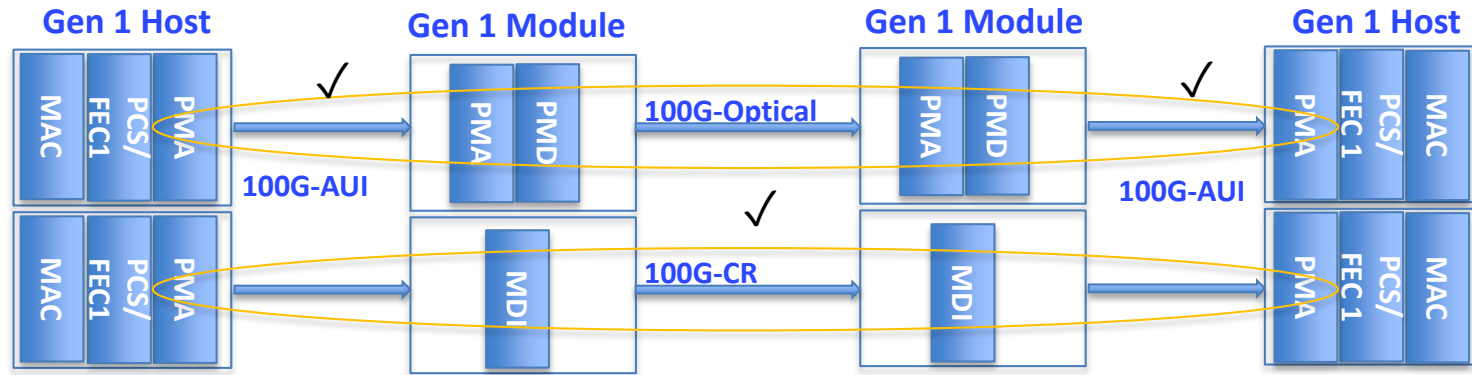
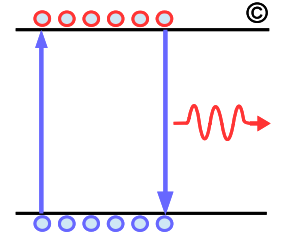

I. **1<sup>st</sup> 800 GbE deployment will be based on 100G/lane and end-end RS (514,544) FEC “KP4”**

- 1<sup>st</sup> 800 GbE optical deployment
- 1<sup>st</sup> CR/KR deployment

II. **2<sup>nd</sup> Gen 800 GbE will be based on 200G/lane optical PMDs and end-end RS (514,544) FEC**

- These PMDs will plug into the Gen 1 host
- Concatenated RS(514,544)+ SFEC (soft decision) on top of FEC1 is the only compatible option
- SFEC can have 1.61-2.7 dB additional NCG

III. **1<sup>st</sup> Gen 800 GbE coherent based on segmented FEC**

- Example of FEC2 are CFEC, SFEC+, etc.

IV. **2<sup>nd</sup> Gen 800 GbE PMDs (200G/lane) based on new strong FEC3 must plug into systems with RS (514, 544) FEC**

- Example of FEC3 is RS (514, 576) FEC
- Require termination of (514, 544) in modules!

# 2<sup>nd</sup> Generation 800 GbE Systems Based on 200G AUI

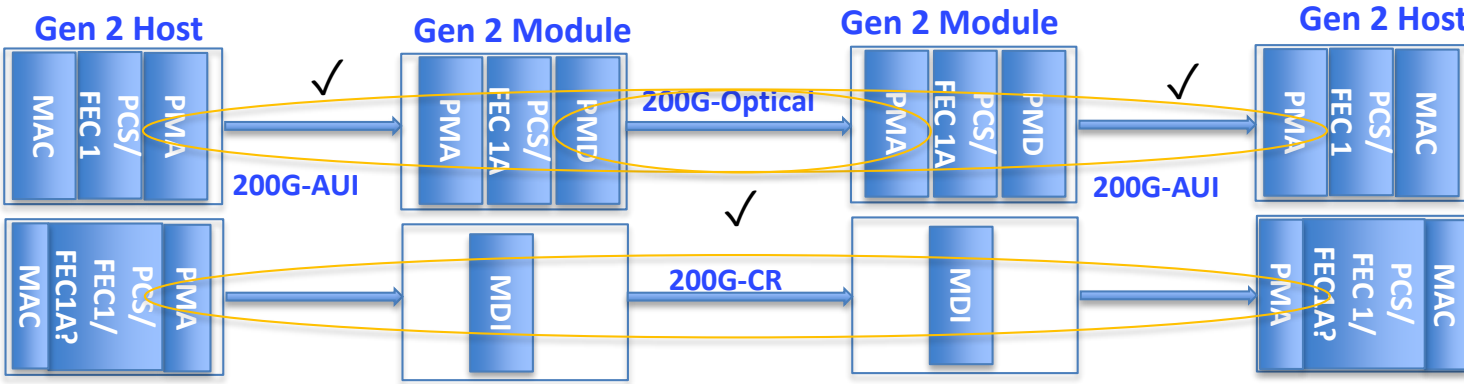
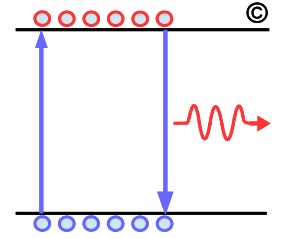

I. **2<sup>nd</sup> Generation 800 GbE system based on 200G I/O with end-end RS (514,544) FEC offer seamless upgrade path**

- Optical PMDs based on 200G/lane replace 100G-AUI with 200G-AUI
- CR PMDs based on 200G/lane may operate with just FEC1 or optionally for greater reach may utilize FEC1A

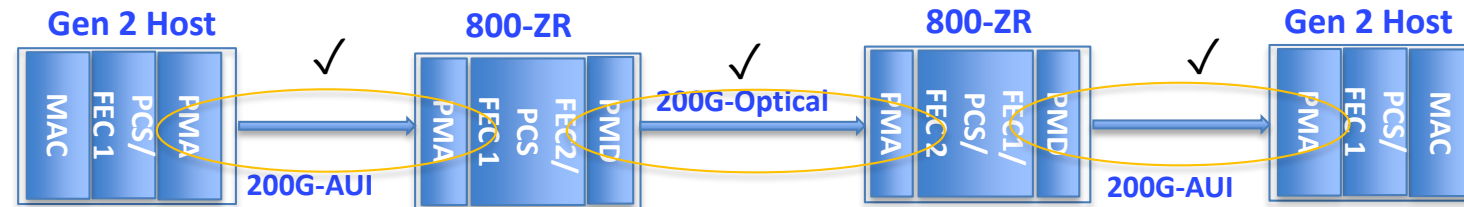

II. **2<sup>nd</sup> Gen 800 GbE system with coherent**

- Segmented RS(514,544)+CFEC, SFEC+, etc.
- Replace 100G-AUI with 200G-AUI

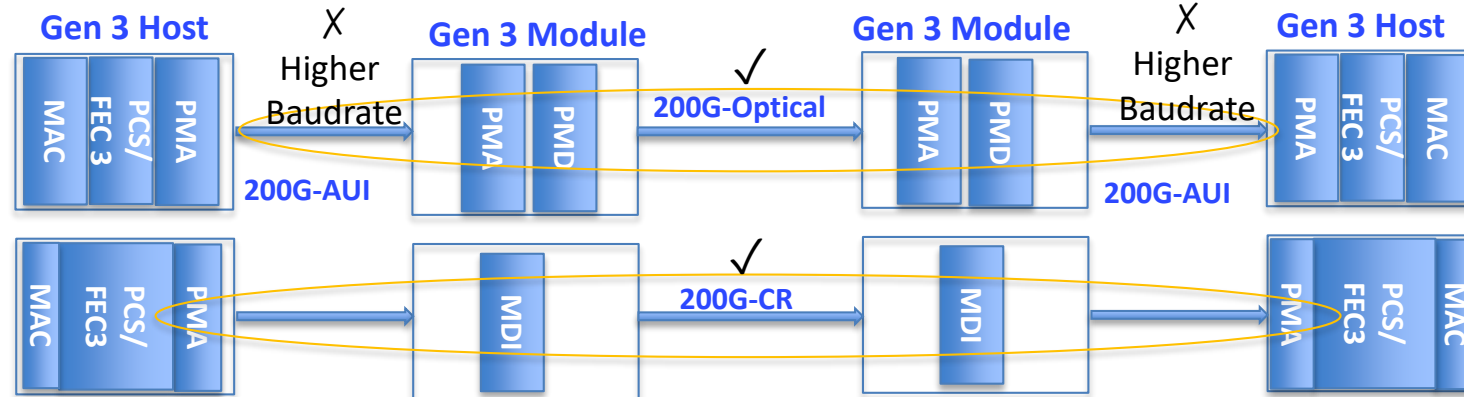

III. **2<sup>nd</sup> Gen 800 GbE will be based on 200G/lane optical PMDs and end-end RS (514,576) FEC3**

- To realize the benefits require forklift upgrade to Gen3 host and Optics
- Forces 200G-AUI and 200G-CR to higher Baudrate!



# 1<sup>st</sup> and 2<sup>nd</sup> Gen 800 GbE Evolution with Concatenated SFEC

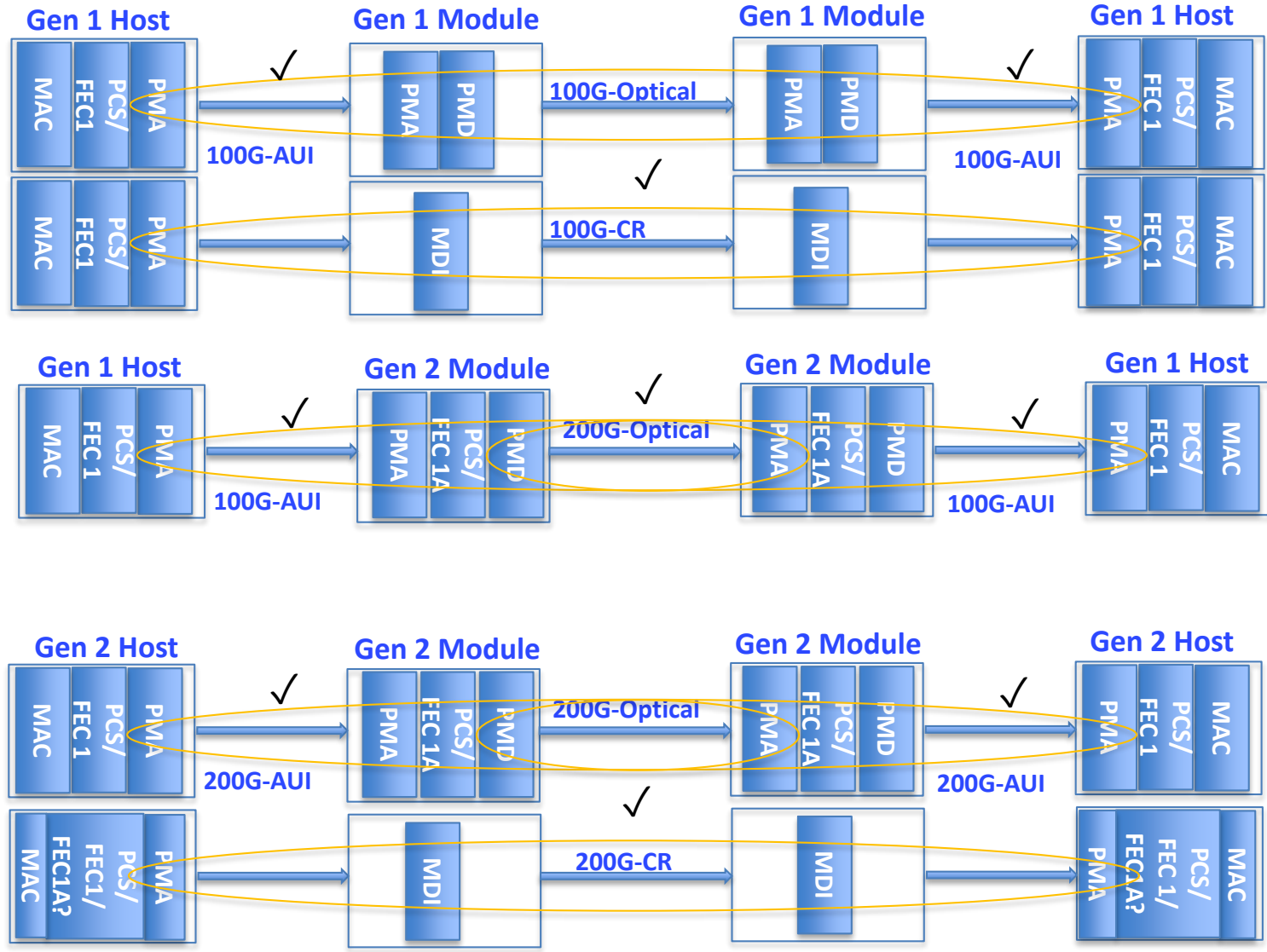
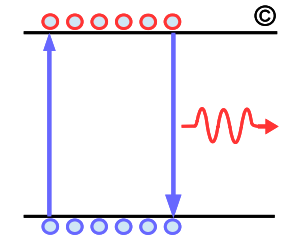

- I. **1<sup>st</sup> 800 GbE deployment will be based on 100G/lane and end-end RS (514,544) FEC “KP4”**
  - 1<sup>st</sup> 800 GbE optical deployment
  - 1<sup>st</sup> CR/KR deployment
  
- II. **2<sup>nd</sup> Gen 800 GbE will be based on 200G/lane optical PMDs and end-end RS (514,544) FEC**
  - These PMDs will plug into the Gen 1 host
  - Concatenated RS(514,544)+ SFEC (soft decision) on top of FEC1 is backward compatible
  - SFEC NCG 1.61-2.9 dB
  
- III. **2<sup>nd</sup> Generation 800 GbE system based on 200G I/O with end-end RS (514,544) FEC offer seamless upgrade path**
  - Optical PMDs based on 200G/lane replace 100G-AUI with 200G-AUI
  - CR PMDs based on 200G/lane may operate with just FEC1 or FEC1+SFEC.

# Summary

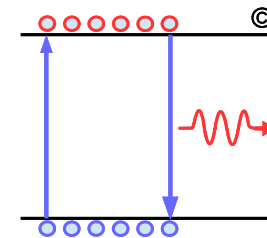

- ❑ **Adopting CL119 style PCS with RS (514, 544) FEC “KP4” [shrikhande 3df 01 220517](#) for 800 GbE based on 32 VLs allow 800 GbE eco-system proceed to deployment based on 100G PMDs and 100G-AUI**
  - Need to get to D2.0 given that products are already in development
- ❑ **Concatenated SFEC [bliss 3df 01a 220517](#) and [patra 3df 01 220518](#) provides 2+ dB of NCG on top of RS(514,544) FEC assuming at least 4-way interleaving**
  - The combination of RS(514,544) FEC with concatenated SFEC provide seamless migration from 100G-AUI systems to 200G-AUI systems
  - Stronger RS FEC such as (514,576) doesn't provide seamless migration
- ❑ **Based on initial analysis need to define 3 classes of 200G AUIs**
  - Conventional C2M TP0-TP1a loss increases from 16 to 21 dB – likely will operate with terminated FEC
  - C2M/CR or NPO/CR with Flyover cable the TP0-TP1a loss remain at 11 dB to support optics and CR – operates with end-end FEC
  - NPO bump-bump loss will increase from 13 dB to ~18.5 dB supports optics/active Cu – operates with end-end FEC
- ❑ **RS(514, 544) in conjunction with concatenated SFEC not only provide seamless migration but also offer more flexible overall solution for 200G-CR and 200G-AUI than new end-end FEC such as RS(514,576)!**