



802.3 Standards Development Lessons Learned

Brad Booth
Sr. Solutions Architect, AMCC
Sept. 13, 2006

Outline

- Lessons Learned
- Standards Development Process
- Study Group Phase
- Final Thoughts

Outline

- Lessons Learned
- Standards Development Process
- Study Group Phase
- Final Thoughts

Lessons Learned

- Past experiences
 - Editor-in-Chief, IEEE Std. 802.3ae-2002
 - Chair, IEEE Std. 802.3an-2006
- Get the easy objectives out of the way early
 - Full duplex
 - 802.3/Ethernet frame format
 - Min. and max. frame size
- Tougher objectives can take up to a year
- Knock out objectives first, then 5 criteria and PAR
- Consumption of alcohol may cause discussions about standards to appear more interesting than they really are.

Outline

- Lessons Learned
- **Standards Development Process**
- Study Group Phase
- Final Thoughts

IEEE Standards Structure

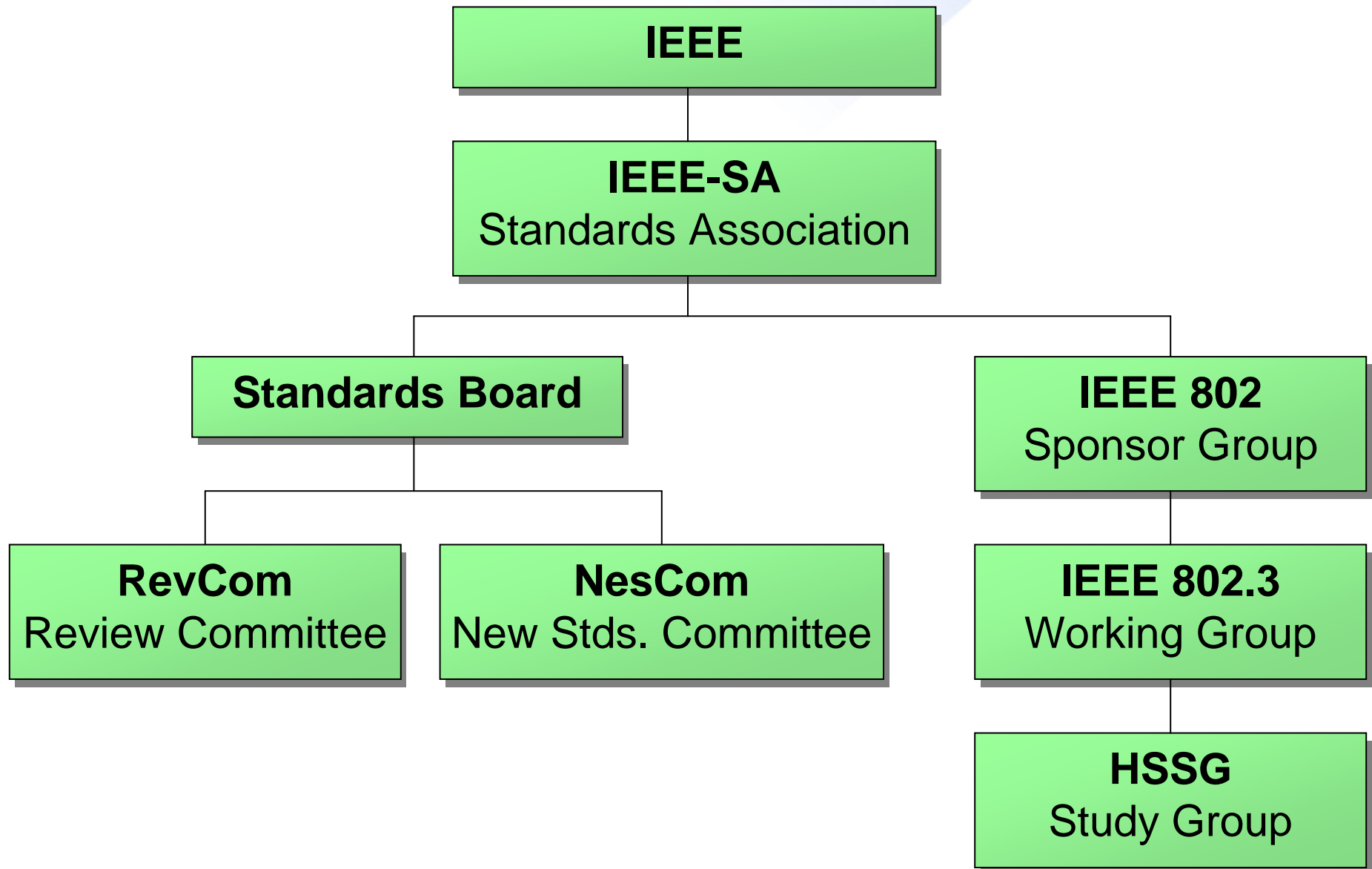

IEEE Standards Process

Study Group Formation

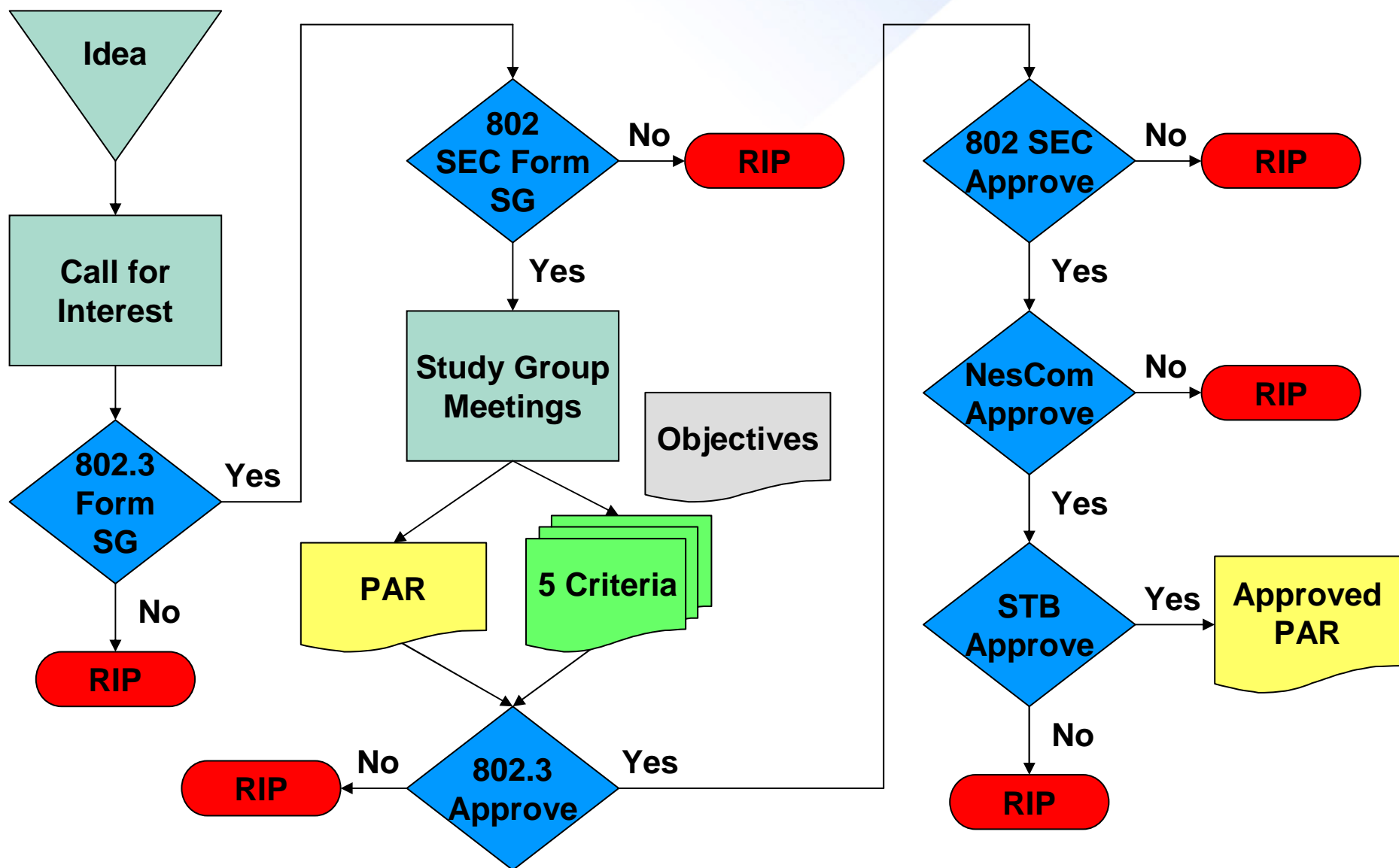

IEEE Standards Process

Task Force Review

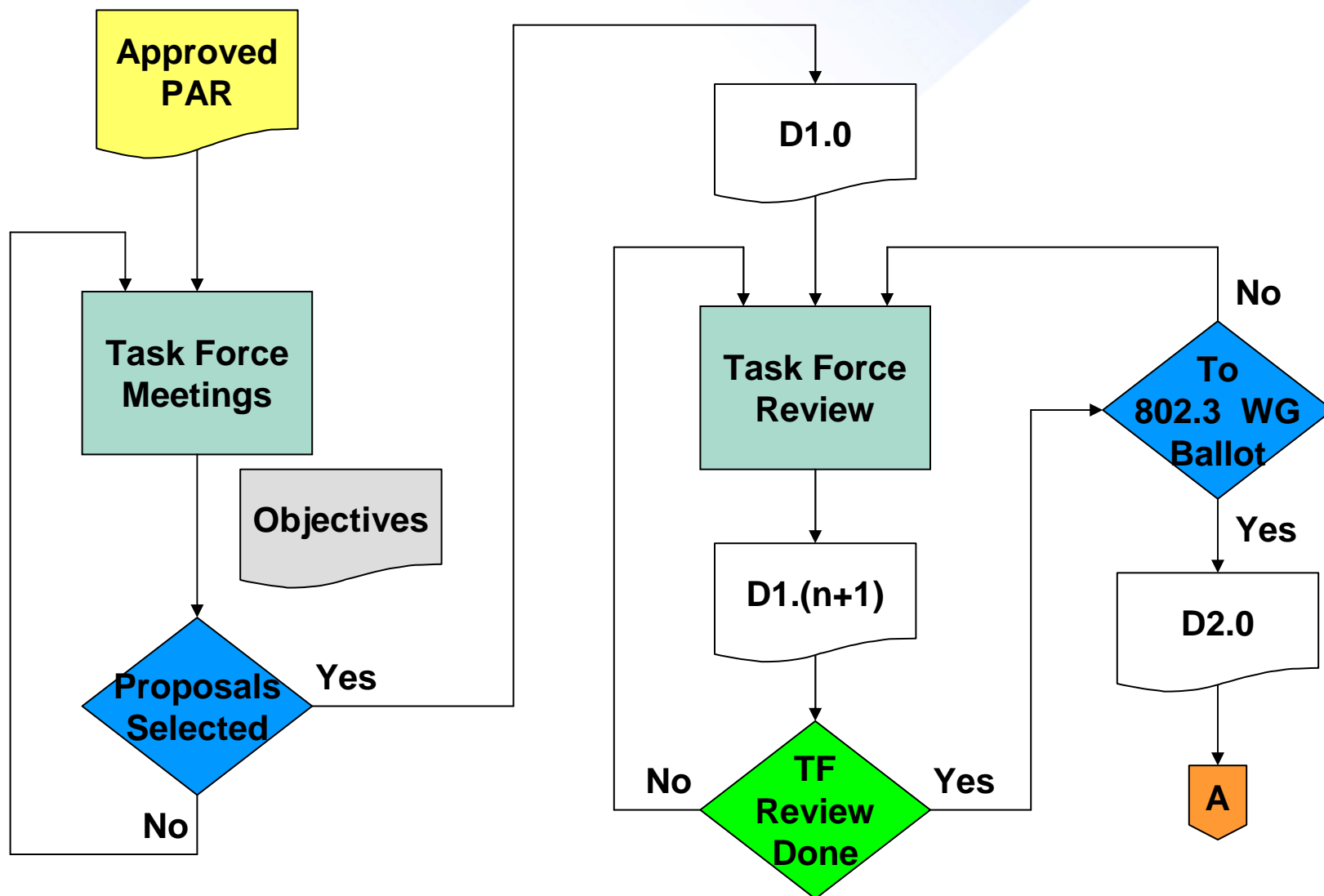

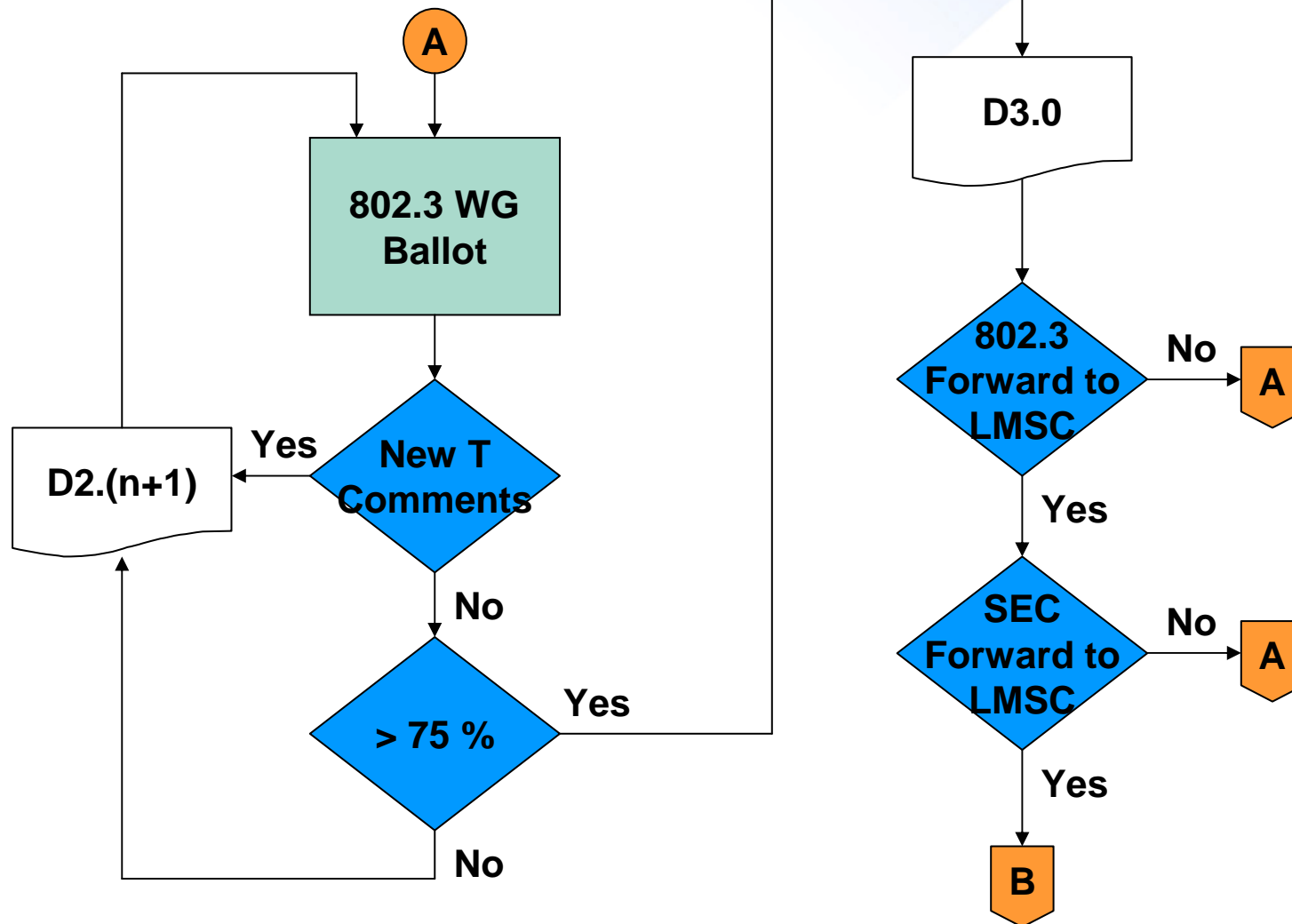

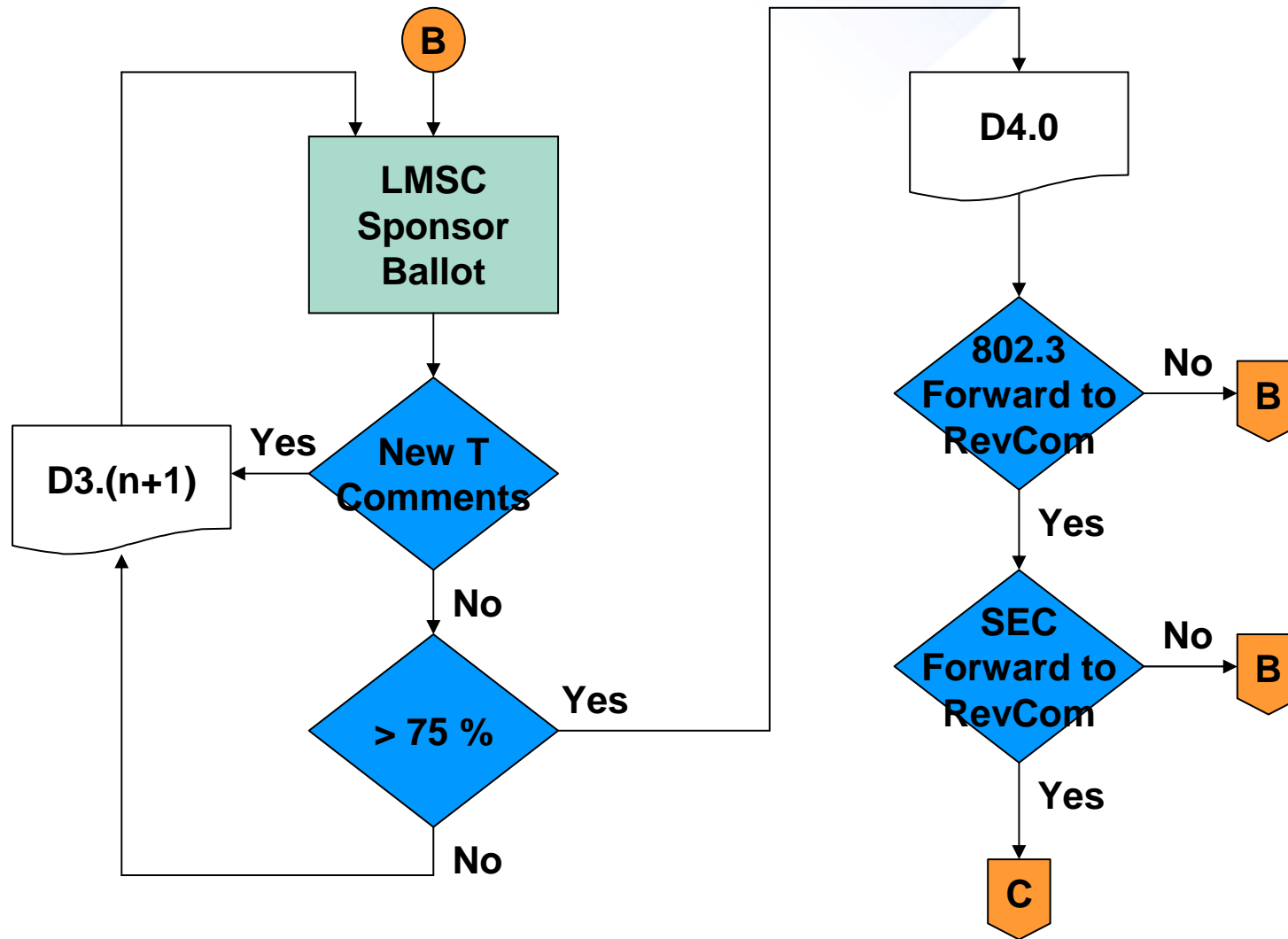

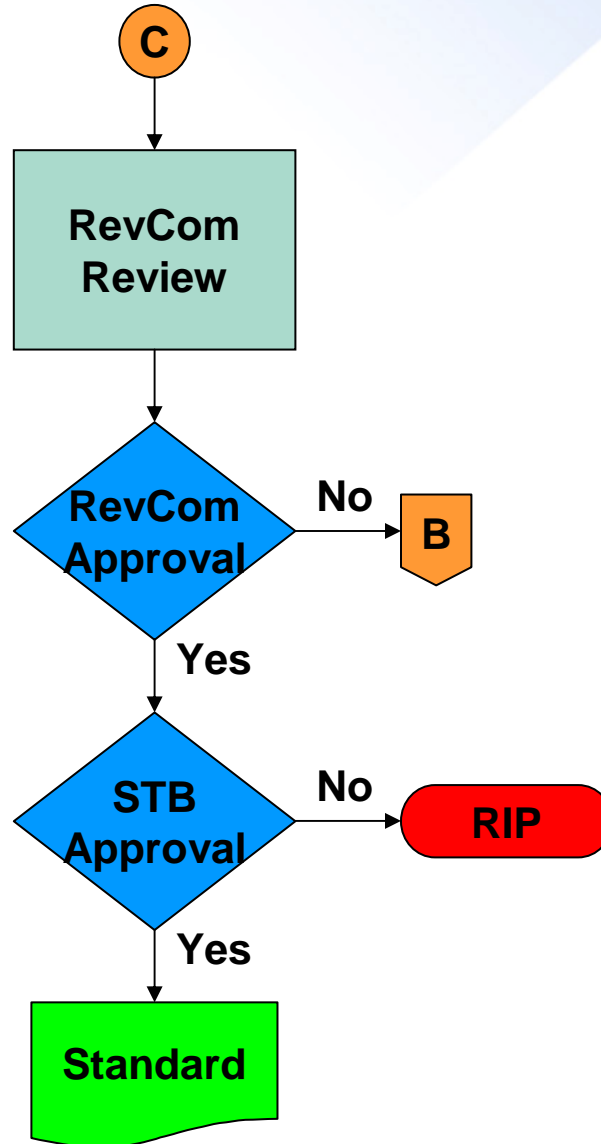

Outline

- Lessons Learned
- Standards Development Process
- **Study Group Phase**
- Final Thoughts

Study Group Phase

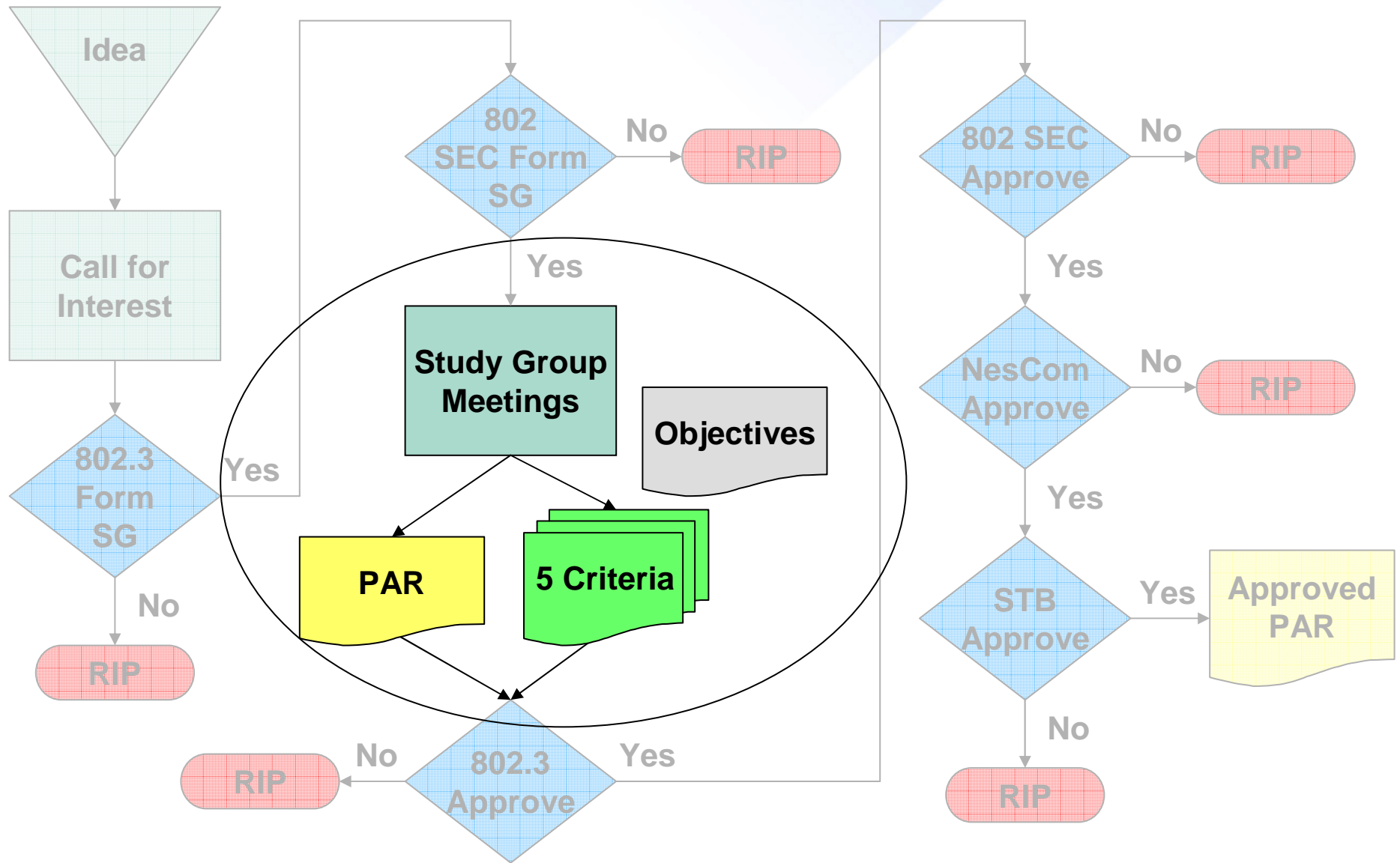

Documents

- Three documents required
 - Project Authorization Request (PAR)
 - 5 Criteria (aka 5 Critters)
 - Objectives
 - No draft standard!!
- PAR
 - Needs approval from HSSG, 802.3 WG, 802 EC, NesCom & IEEE-SA Standards Board
 - Once approved, HSSG will become an 802.3 Task Force
 - Very easy to do once the other documents are done
 - Should be the last document to be worked on

Documents (cont.)

- 5 Criteria

- Needs approval from HSSG, 802.3 WG, 802 EC
- Compatibility and Distinct Identity
- Technical Feasibility
- Broad Market Potential and Economic Feasibility
- Should be worked on after the objectives are set

- Objectives

- Needs approval from HSSG, 802.3 WG
- Takes the most time
- Some are simple, but a number of them will be contentious
- Do this first

Tough Objectives

- Level setting
 - Learn 802.3 terminology
 - Develop new terminology where appropriate
- Consensus
 - 75% to adopt
 - Solo efforts are not effective, find co-travelers early
- Stay focused
 - Form ad hocs to close on specific tasks
 - Avoid “let the market decide” mentality
- Work outside the meetings

Outline

- Lessons Learned
- Standards Development Process
- Study Group Phase
- **Final Thoughts**

Final Thoughts

- Study group phase
 - Consensus permits the effort to move forward
 - Find objectives that are inclusive to create greater consensus
 - Keep objectives simple and to the point
- Develop objectives for the scope of a standard to permit implementations
 - Implementations are what you build relative to a standard
 - Standards are not data sheets
 - The standard is a specification that satisfies the objectives

First, and foremost, develop the Objectives!!

- Thank you!